

**3M™ Dynatel™**

**Cable/Pipe/Fault Advanced Locator  
2250M/2273M Series**

**(With 3-watt, 5-watt, or 12-watt Transmitter)**

**Operator's Manual**

**2250M**

**2250M-iD**

**2273M**

**2273M-iD**



# Contents

1. Safety Information .....	6
A. Intended Use .....	6
2. About This Manual .....	7
3. Quick Start .....	8
A. Transmitter Battery Installation .....	8
B. Receiver Battery Installation .....	9
C. Cleaning .....	10
D. Service and Accessories.....	10
E. 2250 Transmitter Keypad and Connector Definitions.....	10
F. 2273 Transmitter Keypad and Connector Definitions .....	11
G. Maximum Transmitter Output .....	12
H. Rechargeable Battery .....	12
I. 2250M Receiver Key Pad and Display Definitions .....	13
J. 2273M Receiver Key Pad and Display Definitions .....	14
4. Menu Displays .....	15
A. Main Menu .....	15
5. Configuring The Receiver .....	18
A. Select Depth Units .....	18
B. Setting the Receiver Clock .....	18
C. Selecting a Language .....	18
D. Enabling/Disabling Frequencies .....	19
E. Selecting External Jack Frequencies (Tone Frequencies) .....	19
F. Creating User Defined Frequencies .....	19
G. Filtering Power Frequency Interference .....	20
H. Selecting Locating Audio .....	20
6. Buried Cables And Pipes: Transmitter Connections .....	21
A. Direct Connect Method .....	21
B. Dyna-Coupler Method .....	23
C. Induction Method.....	24
7. Receiver Modes .....	28
A. Directional Peak (Dir Pk) .....	28
B. Directional Null (DirNull) .....	28
C. Special Peak (Spl Pk).....	29
D. Induction Peak (Ind Pk).....	30
E. Expanded Mode .....	30
8. Depth and Current Estimate .....	30

9. Locating Frequencies .....	31
A. Active Frequencies .....	31
B. Power Frequencies .....	32
C. Passive Frequencies .....	32
D. Auxiliary Frequencies .....	32
10. Locating in Directional Peak Mode .....	33
11. Locating Active Duct Probes (Sondes) .....	35
A. Determining ADP Depth .....	35
12. Locating Buried Sheath Faults and Earth-Return Faults .....	36
A. Transmitter Setup .....	36
B. Pinpointing the Buried Fault .....	37
13. Locating 3M™ Electronic Markers and 3M™ iD Markers .....	39
A. Enabling/Disabling Marker Types .....	39
B. Alert Mode .....	39
C. Single Marker Locate .....	40
D. Dual Marker Locate .....	41
E. iD Marker Depth .....	41
F. Passive Electronic Marker (Non-iD) Depth .....	42
14. Creating/Editing Templates for 3M™ iD Markers .....	43
A. Creating New Templates .....	43
B. Editing Templates .....	45
15. Writing iD Markers .....	46
A. Modifying Marker Data to be Written .....	47
16. Reading iD Markers .....	48
17. Reviewing Marker Read/Write History .....	49
A. Read History .....	49
B. Write History [SK] .....	50
18. GPS Operation .....	50
A. Activation Key .....	50
B. Serial Number and Software Version .....	50
C. Inputting the GPS Activation Key .....	50
D. Communicating with the GPS Device .....	51
E. Capturing the GPS Coordinates (Capture Mode / Mode 1) .....	51
F. Sending iD Marker Data to GPS (Capture-Transmit Mode / Mode 2) .....	52
G. Path Mapping with GPS .....	52

19. Additional Applications ..... 53  
    A. Aerial Faults (Toning)..... 53  
    B. Cable Identification ..... 55  
20. Help Mode ..... 56  
21. 3M™ Dynatel™ PC Tool Kit and Locator Software Upgrades..... 56  
22. Self Test Of Receiver ..... 57  
23. Product Description And Optional Accessories ..... 57  
    A. Product Description ..... 57  
    B. Standard Configurations ..... 58  
    C. Optional 3M™ Dynatel™ Accessories ..... 59  
24. Receiver Specifications ..... 60  
25. Transmitter Specifications ..... 62  
26. Environmental and Regulatory Specifications ..... 63  
27. Rechargeable Battery Information ..... 63

Congratulations! You have just purchased one of the finest, most advanced locating devices available today!

The 3M™ Dynatel™ Cable/Pipe/Fault Locators 2250M-iD/2273M-iD are designed with all of the functionality of previous Dynatel models, and iD versions have the enhanced capability to read and write user information into the 3M iD markers. Information such as a pre-programmed identification number, facility data, application type, placement date and other details can all be read, stored and downloaded to your PC for enhanced resource management with this revolutionary equipment. The Dynatel Cable/Pipe/Fault Locators 2250M-iD/2273M-iD will also search for two different types of utility markers simultaneously. When used in conjunction with a hand-held GPS device the ability to transmit path and marker coordinates multiplies the potential to the mapping industry. This equipment provides a simple system for mapping utility information directly into CAD and GIS systems.

The 2250M/2273M Series transmitters are available in 3-watt, 5-watt and 12-watt units. 12 watts for the 12-watt transmitter, or 5 watts for the 5-watt transmitter, is attained by utilizing the Cigarette Lighter Adapter or External Rechargeable Battery (2200RB).

3M is dedicated to bringing you premium equipment with outstanding reliability, backed by one of the best warranties in the business and outstanding service.

Visit our website at [www.3M.com/dynatel](http://www.3M.com/dynatel) for more application notes and product information.

# 1. Safety Information

Please read, understand and follow all safety information contained in these instructions prior to the use of the 3M Cable/Pipe/Fault Advanced M-Series Locator. Retain these instructions for future reference.



## A. Intended Use

The 3M Cable/Pipe/Fault Advanced M-Series Locator is used to identify the placement of underground utility lines. The system must be installed as specified in the 3M Cable/Pipe/Fault Advanced Locator 2250M/2273M Series Operator Manual. It has not been evaluated for other uses or locations. If this equipment is used in a manner not specified by 3M, the protections provided by the equipment may be impaired.

### WARNING

If this equipment is used in a manner not specified by 3M, the protections provided by the equipment may be impaired.

### Explanation of Signal Word Consequences

 <b>Warning:</b>	Indicates hazardous situation which if not avoided, could result in death or serious injury.
 <b>Caution:</b>	Indicates hazardous situation which if not avoided, could result in minor or moderate injury.

### Explanation of Product Safety Label Symbols



Do not throw away in normal trash.



Warning: Risk of electric shock

### WARNING

This WARNING applies to the following 3M Dyna-Couplers;

- 3" (75 mm) - Part number 3001
- 4.5" (114 mm) - Part number 4001
- 6" (150 mm) - Part number 1196
- All accessory kits containing any of the listed Dyna-Couplers - Part numbers 3019, 4519, 1196/C

A potential for electrical shock exists when using the Dyna-Coupler on cables energized with electrical power. Use appropriate safety procedures.

**DO NOT USE ON CABLES CARRYING IN EXCESS OF 600 VOLTS RMS.**

## **⚠ WARNING**

This WARNING applies to the use of the Direct Connect Cables and the Transmitter.

To avoid potential shock, or electrically damaging the Transmitter, when setting up the Transmitter to locate using the Direct Connect method, follow these basic steps;

- ALWAYS plug the Direct Connect Cable into the Transmitter Output Jack [T-6] BEFORE connecting the leads to the cable/pipe to be located and the ground rod.
  - Connect the red lead to the cable/pipe.
  - Connect the black lead to ground rod.

**A POTENTIAL FOR ELECTRICAL SHOCK, AND/OR TRANSMITTER ELECTRICAL DAMAGE, EXISTS WHEN USING THE DIRECT CONNECT CABLE ON CABLES ENERGIZED WITH ELECTRICAL POWER IF THE ABOVE INSTRUCTIONS ARE NOT FOLLOWED. USE APPROPRIATE SAFETY PROCEDURES. CHECK VOLTAGE BEFORE CONNECTING TRANSMITTER. VOLTAGE HIGHER THAN 240 VOLTS WILL DAMAGE EQUIPMENT. FOLLOW STANDARD PROCEDURES FOR REDUCING THE VOLTAGE.**

## **2. About This Manual**

There are two basic models included in the 3M Dynatel Locator 2200M Series. The 2250M is designed for cable/pipe locating. The 2273M is designed for cable/pipe and fault locating. The iD option (read/write capability to 3M™ iD Markers) is available for both models. There are three transmitter options: 3 Watt, 5 Watt, or 12 Watt.

This instruction manual will include all features. All instructions are applicable to all products, unless noted.

The 12-watt transmitter option offers additional power output levels for improved induction performance and 8 kHz (low frequency) induction for shallow facilities, such as risers. Output Power up to 12 Watts for the 12-watt transmitter is achieved using the supplied external power source. The maximum output power in Direct Connect method is reduced to below FCC limits. (FCC limits: 1 Watt at 200 kHz and 10 Watts at 33 kHz)

In order to demonstrate all available functions, the illustrations depict the 2273M-iD receiver unit and the 2250 and 2273 12-watt transmitters. The 2250M receiver may vary from the illustrations shown.

# 3. Quick Start

## A. Transmitter Battery Installation

Loosen the six screws on the battery compartment cover on the bottom of the transmitter. Remove the cover.

Install six 'C' size alkaline cell batteries (LR14) into the compartment as indicated by the polarity symbols (+ and -).

Replace the cover and tighten the screws.

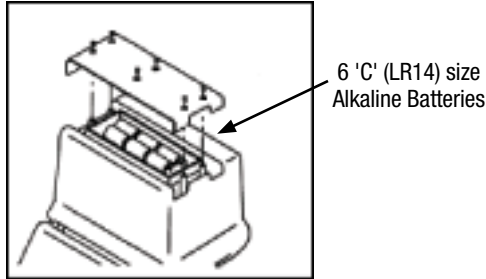

Press and hold OFF [T-1] to manually test the batteries. The display and audio will indicate one of the following levels: (OK w/solid tone = good; LO w/beeping tone = low; "--" w/no tone = replace)

### Caution

#### To reduce the risks associated with fire and explosion:

- Do not short, excessively heat, or dispose of batteries in fire.
- Install batteries with proper polarity.
- Use only Alkaline "C" (LR14) sized batteries.
- Do not charge batteries
- Do not use leaking batteries

#### To reduce the risks associated with environmental contamination:

- Dispose of batteries and electronic components in accordance with all regulations.
- Ensure batteries are installed with correct polarity.
- Always remove batteries when storing the units for long periods of time.



## B. Receiver Battery Installation

Remove cap from receiver handle.

Install eight 'AA' size alkaline cell batteries (LR6) into the battery holder as indicated by the polarity symbols (+ and -).

Attach battery holder to the PP3 connector in the receiver handle, and slide holder into the handle. Replace the cap.

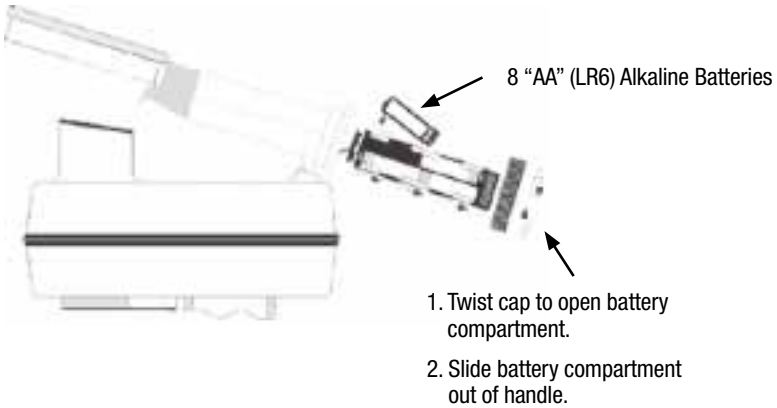

### Caution

#### To reduce the risks associated with fire and explosion:

- Do not short, excessively heat, or dispose of batteries in fire.
- Install batteries with proper polarity.
- Use only Alkaline "AA" (LR 6) sized batteries.
- Do not charge batteries
- Do not use leaking batteries

#### To reduce the risks associated with environmental contamination:

- Dispose of batteries and electronic components in accordance with all regulations.
- Ensure batteries are installed with correct polarity.
- Always remove batteries when storing the units for long periods of time.

The receiver batteries are tested for two seconds every time the unit is turned on.

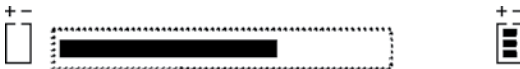

The bar graph on the display will fill to the relative battery level.

The Battery Icon [8] on the Locating Displays will continuously indicate the battery level.

## C. Cleaning

---

Use a soft damp cloth to clean the product and test leads if necessary.

## D. Service and Accessories

---

Information regarding service, accessories, or replacement parts can be obtained by contacting 3M at 1-800-426-8688.

This equipment does not require annual calibration or maintenance.

## E. 2250 Transmitter Keypad and Connector Definitions

---

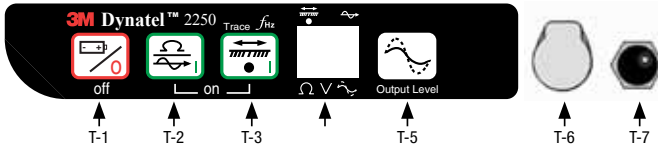

[T-1] **off:** Turns unit off and performs battery test.

[T-2] **on: Ohm-meter / Tone:** Turns the unit on and cycles through the following commands when pressed repeatedly.

**Ohm-meter:** Measures the continuity of the trace conductor/pipe and its far-end ground. It is also used to measure the fault resistance to earth.

**Tone:** In the tone mode, the transmitter generates 577 Hz and 200 kHz signals.

[T-3] **on: Trace (frequency):** Turns the unit on and places the unit in Trace mode.

**Select Frequency:** Press Trace [T-3] repeatedly to cycle through the transmitter's active frequencies (577 Hz, 8 kHz, 33 kHz, and 200 kHz). The selected frequency will be displayed [T-4]. 'ALL' indicates that the following active frequencies are transmitting simultaneously: 577 Hz, 8 kHz, 33 kHz, and 200 kHz.

[T-4] **Digital Display:**

**Indicator Flags:** These flags coincide with the operational mode of the transmitter. (From top left to bottom right) Trace mode [T-3], Tone mode [T-2], Ohm-meter [T-2], Voltage (at start up the transmitter checks for foreign voltage), and the Output Level Flag (no flag = normal output; flag = high output; flashing flag = maximum output).

**Digital Display:** Indicates frequency, relative current, resistance, battery level and voltage (if present on target).

[T-5] **Output Level:** Cycles output level; normal, high and maximum.

Normal=No Flag; High=Flag; Maximum=Flashing Flag (indicated in *Digital Display* [T-4])

**NOTE:** An external 12-volt power source is required to obtain Max Output level (12 watts for 12-watt transmitters and 5 watts for 5-watt transmitters).

**NOTE:** 12 Watt Output Level varies by frequency. Output is limited to 10 watts at 33 kHz and 1 watt at 200 kHz using the direct connection method.

**[T-6] Output Jack:** Port for direct connect cables or Dyna-coupler.

**[T-7] External Jack:** Port to connect cigarette lighter adapter cable, or rechargeable battery (2200RB). Input voltage level: 9-18 VDC. (Only on 5-watt and 12-watt transmitters.)

## F. 2273 Transmitter Keypad and Connector Definitions

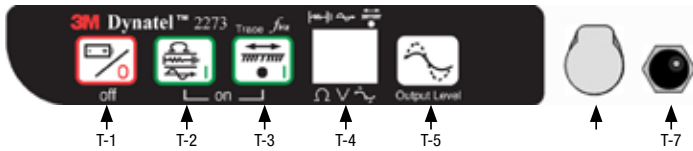

**[T-1] off:** Turns unit off and performs battery test.

**[T-2] on: Ohm-meter / Fault Locate / Tone:** Turns the unit on and cycles through the following commands when pressed repeatedly.

**Ohm-meter:** Measures the continuity of the trace conductor/pipe and its far-end ground. It is also used to measure the fault resistance to earth.

**Fault Locate:** (2273M units only) In this mode, the transmitter sends two alternating locating frequencies (577 Hz and 33 kHz) as well as fault signals 10 and 20 Hz.

**Tone:** In the tone mode, the transmitter generates 577 Hz and 200 kHz signals.

**[T-3] on: Trace (frequency):** Turns the unit on and places the unit in Trace mode.

**Select Frequency:** Press Trace [T-3] repeatedly to cycle through the transmitter's active frequencies (577 Hz, 8 kHz, 33 kHz, and 200 kHz). The selected frequency will be displayed [T-4]. 'ALL' indicates that the following active frequencies are transmitting simultaneously: 577 Hz, 8 kHz, 33 kHz and 200 kHz.

**[T-4] Digital Display:**

**Indicator Flags:** These flags coincide with the operational mode of the transmitter. (From top left to bottom right) Fault mode [T-2] (2273 units only), Tone mode [T-2], Trace mode [T-3], Ohm-meter [T-2], Voltage (at start up the transmitter checks for foreign voltage), and the Output Level Flag (no flag = normal output; flag = high output; flashing flag = maximum output).

**Digital Display:** Indicates frequency, relative current, resistance, battery level and voltage (if present on target).

**[T-5] Output Level:** Cycles output level; normal, high and maximum.

Normal=No Flag; High=Flag; Maximum=Flashing Flag (indicated in *Digital Display* [T-4])

**NOTE:** An external 12-volt power source is required to obtain Max Output level (12 watts for 12-watt transmitters and 5 watts for 5-watt transmitters).

**NOTE: 12 Watt Output Level varies by frequency. Output is limited to 10 watts at 33 kHz and 1 watt at 200 kHz using the direct connection method.**

**[T-6] Output Jack:** Port for direct connect cables or Dyna-coupler.

**[T-7] External Jack:** Port to connect cigarette lighter adapter cable, or rechargeable battery (2200RB). Input voltage level: 9-18 VDC. (Only on 5-watt and 12-watt transmitters.)

## G. Maximum Transmitter Output

An external 12V DC source is required for 12-Watt Output (Max setting) using a 12-watt transmitter or 5 watt output (Max setting) using a 5-watt transmitter. Connecting the rechargeable battery (2200RB) to the *External Jack* [T-7] will provide this external source, or the cigarette lighter adapter cable (included with 12-watt and 5-watt transmitters) can be used to connect the DC power from a vehicle's battery source to the transmitter's *External Jack* [T-7].

Press *Output Level* [T-5] twice for maximum output mode.

The indicator flag will flash when the transmitter is in maximum output mode.

**Note: The external DC source does not charge the internal batteries.**

### **⚠ WARNING**

#### **To reduce the risk associated with hazardous voltage:**

- Potential for electric shock exists when handling connection cables while the transmitter is ON. Make all connections prior to powering on the unit. Turn transmitter OFF before handling connection cables.
- Voltage greater than 240 volts will damage equipment and could cause personal injury or death. Make all connections before turning on the transmitter. Follow standard procedures for reducing the voltage.
- Do not change or modify this product in any way.

## H. Rechargeable Battery

The 3M Dynatel Sealed Gel-Cell Battery 2200RB can be used as an auxiliary battery in 3M™ Dynatel™ 2200 Series Transmitters. It plugs into the *External Jack* [T-7] and provides power for the transmitter. When the rechargeable battery is plugged in, normal output, high output, and maximum output are available. When the rechargeable battery is connected to the transmitter, the alkaline batteries are bypassed. The rechargeable battery is a lead acid battery rated at 5.4 amp-hours and is equipped with a user replaceable fuse (5A/32V).



**Note: The internal batteries must be at least 5.4 volts. Do not remove the alkaline batteries from the transmitter when using the rechargeable battery. Rechargeable battery, or cigarette lighter adapter cable, is required for Maximum output level. Rechargeable battery is shown installed in the well of the transmitter case.**

# I. 2250M Receiver Key Pad and Display Definitions

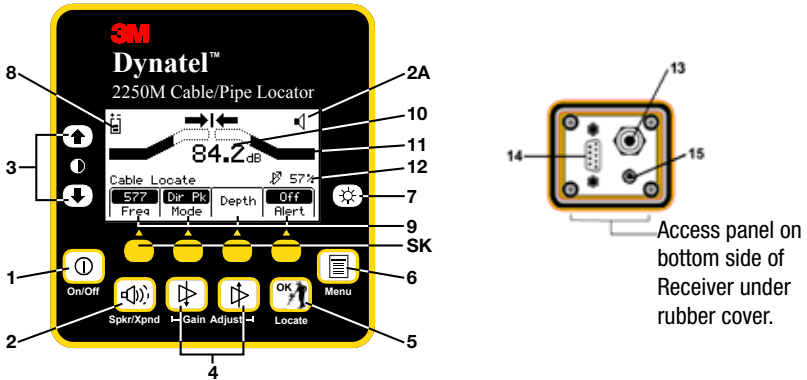

[1] **On/Off (Power):** Turns unit on and off.

[2] **Speaker Volume Control:** Adjusts the volume of the receiver (off, low, med, high, and Xpand).

[2A] **Speaker Volume Icon:** Indicates the relative volume level of the receiver. When the third ring is dotted and 'xpnd' appears below the speaker icon, the receiver is in "Expander" mode. This mode is used to pinpoint the target cable or pipe.

[3] **Contrast:** The arrows located above and below the contrast icon will adjust the contrast of the display.

[4] **Gain Adjust:** Adjusts the sensitivity of the receiver either up or down to maintain a satisfactory signal level.

[5] **Locate/OK:** Sets the receiver to trace mode for locating Cable/Pipe, Markers (for iD units only), Tone. Tone/Ext is used to activate the *External Jack* [13]. Acknowledges setup entries (**OK**).

[6] **Menu:** Displays setup screen for configuration of the unit, i.e.: clock, language, depth units, marker data and frequencies.

[7] **Backlight:** Toggles the backlight low, high, and off.

[8] **Battery Icon:** Indicates battery level.

[SK] **Soft Keys:** There are four soft keys (yellow keys) on the receiver. The function of each key is shown above the yellow key on the display screen. The functions will change, depending on the operation mode of the receiver. For instruction purposes in this manual, the display command is followed by [SK] to identify it as a soft key.

[9] **Soft Key Commands:** Definitions for each of the four soft key functions.

[10] **Signal Strength:** Digital reading of the signal that the receiver is detecting from the target.

[11] **Bar Graph:** Graphical representation of the received signal.

[12] **Gain Level:** Displays relative gain level.

[13] **External Jack:** Port to connect cables from external devices such as the earth frame (A-Frame), a second Dyna-Coupler, or a toning coil.

[14] **Serial Port:** RS232 port to connect the receiver to a PC via serial cable or USB-to-serial adapter cable.

[15] **Earphone Jack:** Will fit standard 1/8" (3.175 mm) mini-jack mono earphone plug (not included).

## J. 2273M Receiver Key Pad and Display Definitions

---

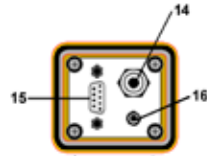
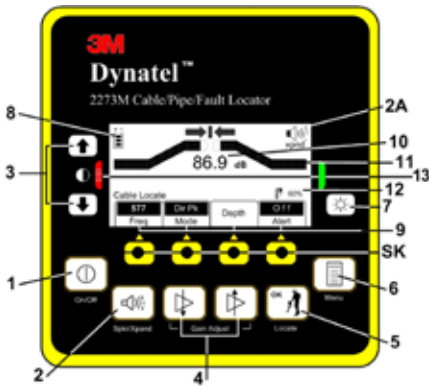

Access panel on bottom side of Receiver under rubber cover.

[1] **On/Off (Power):** Turns unit on and off.

[2] **Speaker Volume Control:** Adjusts the volume of the receiver (off, low, med, high, and Xpand).

[2A] **Speaker Volume Icon:** Indicates the relative volume level of the receiver. When the third ring is dotted and 'xpnd' appears below the speaker icon, the receiver is in "Expander" mode. This mode is used to pinpoint the target cable or pipe.

[3] **Contrast:** The arrows located above and below the contrast icon will adjust the contrast of the display.

[4] **Gain Adjust:** Adjusts the sensitivity of the receiver either up or down to maintain a satisfactory signal level.

[5] **Locate/OK:** Sets the receiver to trace mode for locating Cable/Pipe, Markers (for iD units only), Tone. Tone/Ext is used to activate the *External Jack* [13]. Acknowledges setup entries (**OK**).

[6] **Menu:** Displays setup screen for configuration of the unit, i.e.: clock, language, depth units, marker data and frequencies.

[7] **Backlight:** Toggles the backlight low, high, and off.

[8] **Battery Icon:** Indicates battery level.

[SK] **Soft Keys:** There are four soft keys (yellow keys) on the receiver. The function of each key is shown above the yellow key on the display screen. The functions will change, depending on the operation mode of the receiver. For instruction purposes in this manual, the display command is followed by [SK] to identify it as a soft key.

[9] **Soft Key Commands:** Definitions for each of the four soft key functions.

[10] **Signal Strength:** Digital reading of the signal that the receiver is detecting from the target.

[11] **Bar Graph:** Graphical representation of the received signal.

[12] **Gain Level:** Displays relative gain level.

**[13] Fault Finding Direction Indicators:** Corresponds to the Earth Contact Frame (A-Frame) probe (leg) colors.

**[14] External Jack:** Port to connect cables from external devices such as the earth frame (A-Frame), a second Dyna-Coupler, or a toning coil.

**[15] Serial Port:** RS232 port to connect the receiver to a PC via serial cable or USB-to-serial adapter cable.

**[16] Earphone Jack:** Will fit standard 1/8" (3.175 mm) mini-jack mono earphone plug (not included).

## 4. Menu Displays

### A. Main Menu

---

When the Menu [6] button is pressed, the Main Menu display appears.

The function appears on the display above each soft key.

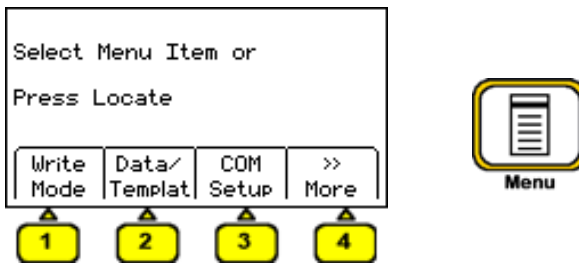

1. **Write Mode:** System used to write information to iD Markers

2. **Data/Template:** Displays marker history and template creation/selection displays:

a. **Read History** – 100 memory locations for Read iD Markers

b. **Write History** – 100 memory locations for Written iD Markers

c. **User Templates** – Create and edit iD templates for iD Markers (max = 32)

d. **Trace Templates** – Create and edit templates used to identify path (max = 5)

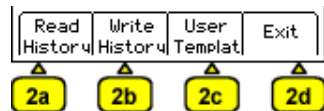

3. **COM Setup:** Displays second level COM Port setting display to configure RS232 port communication with different devices –

- a. **PC** – Receiver will communicate to a computer
- b. **NMEA** – Port is configured to accept coordinates from GPS device
- c. **GIS** – Port is configured to send iD marker information or path information to GPS device and receive coordinates from GPS device.
- d. **PDA** – receiver will send iD marker and path information in ASCII string.

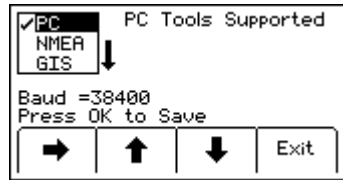

4. **>>More:** Advances to next menu display

5. **<<Back:** Returns to previous menu display

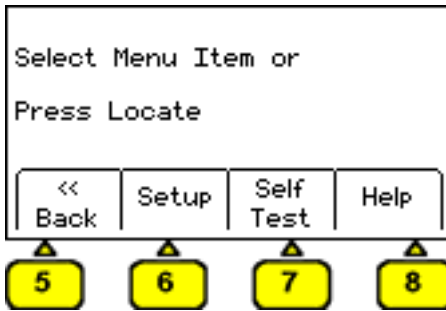

6. **Setup:** Displays second and third level displays for receiver configuration

- a. **Depth Units** – Choose unit of measure; in, ft-in, or cm
- b. **Clock** – Date and time stamped on marker information and depth readings.
- c. **Language** – Toggles between English and alternate language
- d. **>>More** - Advances to next menu display

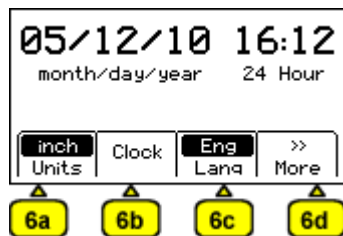



- e. <<Back - Returns to previous display
- f. **Marker Type** – enable and disable marker utility types
- g. **Locate Frequencies** – enable and disable receiver frequencies for locate mode
- h. >>More - Advances to next menu display



- i. <<Back - Returns to previous display
- j. **Tone/Freq** - External Port or Tone Frequencies – enable and disable frequencies that are detectable through the external port of the receiver



- k. **Power Filter Frequency** – Select the power frequency of the region to aid in 50/60 Hz interference rejection when using Auxiliary frequencies
- l. **Audio Configuration** – Select audio response of unit for Directional Peak mode

- 7. **Self Test:** Displays information about receiver unit and performs a self check test

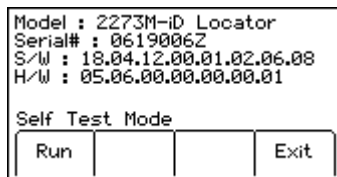

- 8. **Help:** Offers the user basic on-screen instructions

# 5. Configuring The Receiver

In the setup mode, the units of depth measurement, time, date, and date format can be set. The receiver can be configured to detect only certain frequencies and/or specific utility markers (2250M-iD and 2273M-iD receivers only). User defined frequencies can be programmed, language of the receiver can be selected, and tone frequencies set.

## A. Select Depth Units

MENU [6] + >>More [SK:4] + Setup [SK:6] + Units [SKToggle:6a]

1. Press Units [SK toggle:6a].
2. The soft key command will toggle between inches (in), centimeters (cm), and feet/inches (ft-in).
3. Press *Locate/OK* [5].



## B. Setting the Receiver Clock

Set the time, date, and date format of the receiver. Depth and Current measurements are time and date stamped, as well as read write marker information (iD units only).

MENU [6] + >>More [SK:4] + Setup [SK:6] + Clock [SK:6b]

1. Press the left/right arrow [SK] to highlight the digit of the date or time to change.
2. Press the + or - [SK] to increment or decrement.
3. When the date format is highlighted, the format will toggle between mm/dd/yy and dd/mm/yy.
4. Press *Locate/OK* [5] to save, or *Menu* [6] to cancel.



## C. Selecting a Language

MENU [6] + >>More [SK:4] + Setup [SK:6] + Lang [SKToggle:6c]

The soft key command will cycle through available languages. Press *Locate/OK* [5]. Alternate languages can be uploaded to the receiver using the Dynatel™ PCTools software. The 3M™ Dynatel™ PC Tool Kit software is available free of charge at [www.3M.com/dynatel](http://www.3M.com/dynatel) under the Software section; 2550/2573/2250M/2273M/1420 Locator PC Tools xx.x.x (EXE xx.xMB).

## D. Enabling/Disabling Frequencies

---

MENU [6] + >>More [SK:4] + Setup [SK:6] + >>More [SK:6d] + Locate Freq [SK:6g]

The user can select the frequencies that the receiver will detect. All the available frequencies are listed in four groups (Left to Right: Active, Power, Passive, and Auxiliary). The Auxiliary group also contains the User Defined Frequencies. (See *Creating User Defined Frequencies, Section 5F*.)

1. Press the right arrow [SK] to move the highlight bar to the section of frequencies to enable, or disable.
2. Press the up/down arrows [SK] to highlight the specific frequency.
3. Press *Enabl/Disabl* [SK]. (Enable denoted by ✓)
4. Repeat steps 2 & 3 to enable/disable other frequencies.
5. Press *Locate/OK* [5] to save.

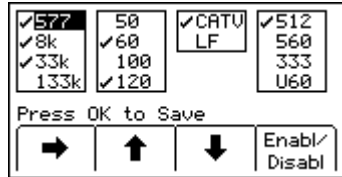

## E. Selecting External Jack [14] ([13] on 2250M) Frequencies (Tone Frequencies)

---

MENU [6] + >>More [SK:4] + Setup [SK:6] + >>More [SK:6d] + Tone Freq [SK:6j]

A coupler can be plugged into the *External Jack* [14] ([13] on 2250M) of the receiver and used to identify cables. (See *Additional Applications: Cable Identification, Section 19B*.) The same procedure as *D. Enabling/Disabling Frequencies* (above) is followed for selecting frequencies that can be detected by the *External Jack* [14] ([13] on 2250M) found on the bottom of the receiver.

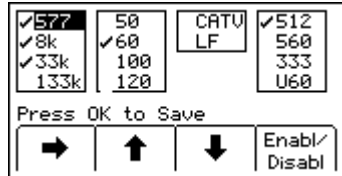

## F. Creating User Defined Frequencies

---

MENU [6] + >>More [SK:4] + Setup [SK:6] + >>More [SK:6d] + Locate Freq [SK:6g]

There are four user defined frequencies available on the receiver. (These frequencies must be between 50 Hz and 999 Hz.) These frequencies are found in the column on the far right of the Locate Freq display (Auxiliary frequencies). These frequencies, once programmed, will appear in the Locate mode under the *Aux* [SK] frequency list when *Freq* [SK] is selected in the Locate mode.

To program the user defined frequencies press the right arrow [SK] to highlight the Auxiliary group of frequencies. Press the up/down arrows [SK] to highlight the user frequency to program. Press *Enabl/Disabl* [SK].

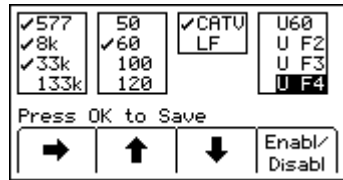

Press the left/right arrows [SK] to move the square cursor to a digit. Press *Select* [SK] to enter the number in the frequency field.

Press *Locate/OK* [5] to save the programmed frequency, or press *Exit* [SK] to cancel. The frequency will appear in the locate frequency display as U ###, where ### represents the selected frequency.

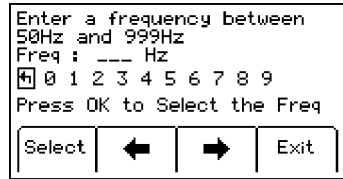

**Note:** To redefine a previously programmed user frequency, highlight the frequency, press *enabl/disabl*, select the back arrow with the cursor, and press *select* to delete the previous entry.

## G. Filtering Power Frequency Interference

MENU [6] + >>More [SK:4] + Setup [SK:6] + >>More [SK:6d] + >>More [SK:6h] + Filter [SK:6k]

In order to filter out unwanted power influences while locating with user-defined frequencies, verify the correct frequency is selected for your location (default is 60 Hz). Press *Locate/OK* [5].



## H. Selecting Locating Audio

MENU [6] + >>More [SK:4] + Setup [SK:6] + >>More [SK:6d] + >>More [SK:6h] + Audio Config [SK:6i]

The user can choose the audio response of the receiver when using the Directional Peak mode for path locating. Highlight the audio selection and press *Locate/OK* [5] to save.

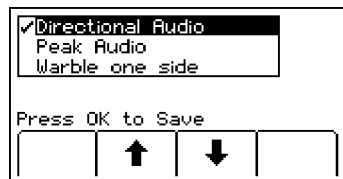

# 6. Buried Cables And Pipes: Transmitter Connections

Perform a battery test. Use one of the following three methods to produce a trace signal on the target pipe or cable.

## A. Direct Connect Method

### **⚠ WARNING**

This WARNING applies to the use of the Direct Connect Cables and the Transmitter. To avoid potential shock, or electrically damaging the Transmitter, when setting up the Transmitter to locate using the Direct Connect method, follow these basic steps;

- ALWAYS plug the Direct Connect Cable into the Transmitter Output Jack [T-6] BEFORE connecting the leads to the cable/pipe to be located and the ground rod.
  - Connect the red lead to the cable/pipe.
  - Connect the black lead to ground rod.

A POTENTIAL FOR ELECTRICAL SHOCK, AND/OR TRANSMITTER ELECTRICAL DAMAGE, EXISTS WHEN USING THE DIRECT CONNECT CABLE ON CABLES ENERGIZED WITH ELECTRICAL POWER IF THE ABOVE INSTRUCTIONS ARE NOT FOLLOWED. USE APPROPRIATE SAFETY PROCEDURES.

CHECK VOLTAGE BEFORE CONNECTING TRANSMITTER. VOLTAGE HIGHER THAN 240 VOLTS WILL DAMAGE EQUIPMENT. FOLLOW STANDARD PROCEDURES FOR REDUCING THE VOLTAGE.

Plug the direct connect cable into the *Output Jack* [T-6] of the transmitter. Connect the black clip to the ground rod. Place the ground rod in the earth perpendicular to the suspected cable/pipe path. If necessary, extend the black lead with the Ground Extension Cable (#9043 available separately).

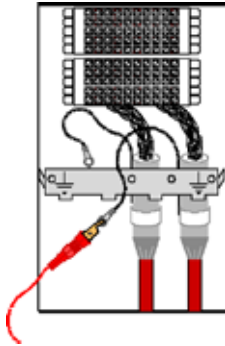

1. Remove the ground bonding and attach the red clip to the shield of the cable, pipe, or target conductor. (If locating power cables, the red clip can be attached to the transformer cabinet, or the meter box). Metal contact must be made between the red clip and the transformer cabinet or meter box. If painted, some paint will need to be removed/scraped off to allow metal-to-metal contact.

2. Turn the transmitter on by pressing *Ohms* [T-2]. The continuity of the circuit will be measured. The results are displayed [T-4] in ohms and as a tone.
  - If the continuity of the circuit is very good (the reading on the display is less than 3K  $\Omega$ . and a solid tone from the transmitter is heard) all frequencies can be used to locate. Always use the lowest frequency available (for example, 577 Hz). Lower frequencies are less likely to 'bleed over' to other cables in the same area, and are very good for tracing over long distances.
  - If the circuit reads more than 3K  $\Omega$ ., but less than 10K  $\Omega$  (indicated by a beeping tone from the transmitter) it will be necessary to use a higher frequency than 577 Hz in order to locate the cable/pipe.
  - If the circuit reads more than 10K  $\Omega$ ., it will be necessary to use an RF signal such as 33 kHz or 200 kHz.
  - If there is no tone and the transmitter indicates that there is an open circuit (OL in the display) this could be an indication of a poor ground, or an open-ended cable or pipe. Use one of the higher frequencies available, at high or maximum output power level. If it is an open-ended cable or pipe, the receiver's response will decrease suddenly at the site of the clear or severed end.

***Note: In the ohms mode, the transmitter can detect voltage as well as ohms. If a low voltage is detected, the display will alternate between displaying ohms and volts. When displaying ohms, the flag over the  $\Omega$  symbol will be visible. When displaying volts, the flag over the 'V' will be visible. When the voltage magnitude is sufficient to impair the accuracy of the ohms measurement, only voltage will be displayed. If the voltage is AC, a sine wave will be visible on the display [T-4]. If a high AC voltage is detected, a rapid beeping tone will be heard.***

3. Press *Trace* [T-3] repeatedly until the desired frequency appears on the display.
4. Press *Output Level* [T-5] to select high or maximum output power level for longer tracing distances or deep pipe/cable.

## B. Dyna-Coupler Method

### ⚠ WARNING

This WARNING applies to the following 3M Dyna-Couplers;

- 3" (75 mm) - Part number 3001
- 4.5" (114 mm) - Part number 4001
- 6" (150 mm) - Part number 1196
- All accessory kits containing any of the listed Dyna-Couplers - Part numbers 3019, 4519, 1196/C

A potential for electrical shock exists when using the Dyna-Coupler on cables energized with electrical power. Use appropriate safety procedures.

**DO NOT USE ON CABLES CARRYING IN EXCESS OF 600 VOLTS RMS.**

Use a ground extension cable, or wire, and ground rod set-up between a target pipe/cable and a gas meter valve/box, or cable/electrical meter box. This will isolate the locate signal to the target pipe/cable section below the meter/box, between the grounding points. This provides a good return path for the tracing signal. Insulating coupling above a gas meter valve on a pipe will isolate the returning signal from ground and may make locating more difficult.

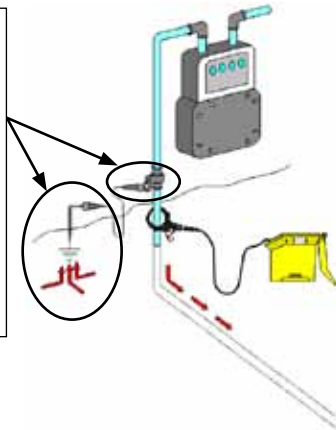

1. Connect the Dyna-Coupler to the transmitter *Output Jack* [T-6] using the coupler cable (9011).
2. Clamp the Dyna-Coupler around the cable or pipe, below any bonds, just before it enters the earth. **The jaws of the coupler must fully close.**
3. Press *Trace* [T-3] to turn on the transmitter. Press again to select 8 kHz, 33 kHz or 200 kHz.

**Note:** When using a Dyna-Coupler, always select high or maximum output power level by pressing the *Output Level* [T-5] key on the transmitter.

## C. Induction Method

---

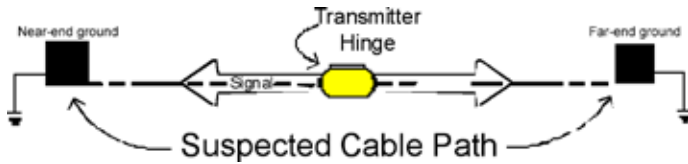

If you cannot make a direct connection, or use the 3M™ Dynatel™ Dyna-Coupler clamp to apply a locating signal on the target, use the induction method. When nothing is plugged into the Output Jack [T-6] of the transmitter the unit will be placed into induction mode when it is turned on. This method uses the internal coil of the transmitter to generate a magnetic field. This is the least preferred method of applying a signal on a target conductor because it can easily be picked up by other non-target conductors in the area. However, it is the preferred method of applying a signal to multiple cables/pipes in the same trench, and for the ‘two-person sweeping’ application.

3M Dynatel transmitters provide a choice of induction frequencies and output power levels. Higher induction output power levels are needed for detecting deeper depths and longer ranges. The 2200M Series 3 Watt transmitters provides two induction frequencies: 33 kHz and 200 kHz. The 12 Watt transmitter provides three induction frequencies: 8 kHz, 33 kHz and 200 kHz. The 200 kHz frequency is commonly used for deeper cables/pipes and the lower frequencies are used to give longer locate distances. The 8 kHz (low frequency) induction helps in locating shallow facilities, such as risers (12 Watt transmitter only.)

The following sections review Non-sweeping and Sweeping (Area) methods used with the Induction Mode. The Non-Sweeping method is utilized when a specific target requires path tracing. The transmitter remains stationary in-line over the target and the path is traced. The Sweeping method is utilized when a designated area needs to be swept for non-specific targets, for example, all the buried pipes or conductors in the designated area. Several sweeping methods will be reviewed.

### A. Non-Sweeping (Passive) Induction Mode Locating

- Position the transmitter over the target facility, with the hinge of the transmitter over and in line with the cable/pipe path. Remove any cables from the *Output Jack* [T-6].
  - Align the Induction Direction arrows on the transmitter with the target conductor.
- Turn on the transmitter, select the frequency and select high output or maximum output power level for best signal-to-noise ratio.
- Trace the signal path with the receiver using the Induction Peak (Ind Pk) mode.

The Induction Peak (Ind Pk) mode of the receiver is a mode in which the upper antenna of the receiver is tuned to minimize distortion from the magnetic field of the transmitter.

Use Induction Peak (Ind Pk) mode when sweeping distance between the transmitter and receiver is 25–60 feet (7.6–20 m). Beyond 60 feet (20 m) you can also use the Special (single) Peak (Spl Pk) or Directional Peak (Dir Pk) modes. Special (single) Peak (Spl Pk) can be used for maximum detection depth and range (needed for deep conductors



and metal pipes), but would require increased sweep distance separation between the transmitter and receiver.

*Note: If nothing is plugged into the Output Jack [T-6] of the transmitter, the transmitter will automatically turn on the internal antennae, and the last frequency used (8 kHz (12 Watt transmitter only), 33 kHz or 200 kHz) will broadcast in induction mode.*

*The induction frequency can be changed by pressing the Frequency button on the transmitter. For best results, the receiver should be at least 25 feet (7.6 m) away from the transmitter to begin tracing the target path and have the gain set between 78-84% when starting the sweep. This is used to establish a baseline gain threshold prior to starting a sweep. When crossing a target pipe or cable, the bar graph will close and the signal strength and audio response will increase. Attempting to trace the target close to the transmitter may lead to false indications due to the receiver detecting the large magnetic field radiating from the transmitter.*

## **B. Sweeping (Active) Induction Mode Locating**

Sweeping an area with the 3M Dynatel 2200M Series locator allows the location of multiple metallic cables and pipes buried in an area without direct connect or coupler access to the cable or pipe. This approach is effective before any excavation takes place. Note that when specific buried objects need to be identified, it's important to use the direct connect or coupler method for applying the signal. This will help limit the applied locate signal to a specific facility that provides more position and depth accuracy along with an effective identification. There are two main types of “no access” or “blind” Induction Sweeps;

**Passive Sweeps:** These require only the use of the Receiver with passive frequency detection capability. This method uses existing external signal sources, such as 60 Hz/50 Hz for electric power, 15 kHz to approximately 30 kHz for low frequency radio signals, 120 Hz / 100 Hz CPS impressed current Cathodic Protection signals and the less commonly occurring CATV signal of 31.25 kHz NTSC with CRT TV turned on.

**Active Sweeps:** These require both the Receiver and Transmitter with Induction capability. This method refers to using a 3M Dynatel transmitter as the signal source through induction, instead of relying on passive frequencies that may exist on the buried conductor or metal pipe. Active Induction allows for detecting buried cables and metal pipes in the absence of passive signals and at deep depths and short sections. 3M Dynatel transmitters provide a choice of induction frequencies and output power levels. Higher induction output power levels are needed for detecting deeper depths and longer ranges. The 2200M Series 3 Watt transmitters provides two induction frequencies: 33 kHz and 200 kHz. The 12 Watt transmitter provides three induction frequencies: 8 kHz, 33 kHz and 200 kHz. The 200 kHz frequency is commonly used for deeper cables/ pipes and the lower frequencies are used to give longer locate distances. The 8 kHz (low frequency) induction helps in locating shallow facilities, such as risers.

## **C. Passive Sweeps**

Select Special (single) Peak (Spl Pk) mode on the receiver and then select the frequency (source; for example, power, LF, etc.) to be traced. Passive sweeps at power frequency will detect buried power cables and conductors carrying 60 Hz/50 Hz power signal in the

ground. Other passive sources exist, such as Cathodic Protection, LF and CATV cable (with NTSC TV CRT turned on).

Walk in a grid pattern over the sweep area holding the receiver as shown in the following illustration. Stop when there is a response increase, locate the position of the maximum signal, follow the conductor path all the way out of the sweep area while putting location marks on the ground. Resume the sweep until another cable or pipe is detected, or the whole area is completely swept. Switch to another available passive frequency in the receiver and sweep again.

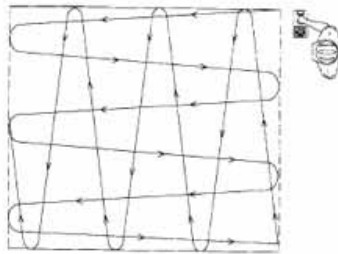

#### D. One-person Active Induction Mode Sweeps

One-person active induction mode sweeps require that the transmitter be set on the ground over the suspected path of the buried infrastructure. The receiver is used to detect signals induced by the transmitter on buried long conductors. Proper placement and orientation is key to maximize the induced signal in the buried cable or metallic pipe enough to be detectable by the receiver along each path in the swept area. (Note that no signal is induced onto a conductor whose path is perpendicular to the Induction Direction indication.)

- Place the transmitter in the upright (bottom on ground) position for directional optimization when aligned with the Induction Direction shown on the label on the transmitter.
- Tip the transmitter over towards the front, and lay it on its front surface, for multi-directional wide area induction. (Note that no signal is induced onto a conductor whose path is directly under the transmitter).
- Remove anything plugged into the *Output Jack* [T-6] (this will place unit in Induction Mode), select highest available frequency (200 kHz) and highest output power level.
- Select the Induction Peak (Ind Pk) mode and 200 kHz frequency on the receiver. When in close proximity to the transmitter in induction mode, there is a direct signal from the induction antenna in the transmitter to the receiver through the air. Induction Peak (Ind Pk) mode is a newly added locate mode for use in closer proximity to a transmitter in Induction mode (<60 ft , 20 m typ.). Special (single) Peak (Spl Pk) would give the highest sensitivity, but is affected by the air signal more than Induction Peak (Ind Pk) mode.

## E. Two-person Active Induction Mode Sweeps

In two-person active induction mode sweeps, one person holds the transmitter and the other holds the receiver while walking together in a sweep pattern detecting long conductors in the ground when crossed by transmitter and receiver positions and orientation, as shown below:

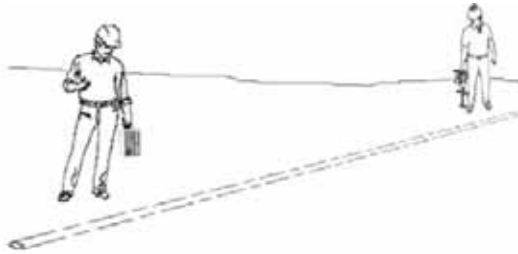

### Transmitter Set-up

- Remove anything plugged into the *Output Jack* [T-6] (this will place unit in Induction Mode), select high frequency (200 kHz), or medium frequency (33 kHz or 82 kHz), and highest output power level.
- Hold the transmitter with the lid facing up and align it with the Induction Direction arrow label, as shown on the transmitter, with the receiver

### Receiver Set-up

- Set the receiver to the same frequency as the transmitter.
- Select the Induction Peak (Ind Pk) mode, and press the *Gain Adjust* [4] (+ or -) key until the bar graph is just visible.

### Sweeping

- Sweeping can be done at close distances between the transmitter and receiver.
- For best results, the receiver should be at least 25 feet (7.6 m) away from the transmitter to begin tracing the target path and have the gain set between 78-84% when starting the sweep. Attempting to trace the target close to the transmitter may lead to false indications due to the receiver detecting the large magnetic field radiating from the transmitter.
- Induction Peak (Ind Pk) mode cancels the air signal coming directly from the transmitter induction antenna to the receiver. Increasing the sweep distance between the transmitter and receiver reduces the direct air signal and allows for sensing deeper conductors and sections of metal pipes. Use Induction Peak (Ind Pk) mode when sweeping distance between the transmitter and receiver is 25–60 feet (7.6–20 m). Beyond 60 feet (20 m) you can also use the Special (single) Peak (Spl Pk) or Directional Peak (Dir Pk) modes.
- Special (single) Peak (Spl Pk) can be used for maximum detection depth and range (needed for deep conductors and metal pipes), but would require increased sweep distance separation between the transmitter and receiver.

# 7. Receiver Modes



## A. Directional Peak (Dir Pk)

Locate/OK [5] + Cable/Pipe [SK] + Mode [SK] + Dir Pk [SK Toggle]

In Dir Pk mode, four peak antennas are used to analyze the magnetic field pattern. The *Bar Graph* [11] indicates *Signal Strength* [10] and the directional arrows sense the edges of the magnetic field. The left/right arrows will indicate the direction to the nearest cable that is in-line with the receiver handle.

As the antenna crosses the cable or pipe, the receiver speaker volume increases to a maximum, the *Bar Graph* [11] fills from both sides toward the middle, and the numeric *Signal Strength* [10] increases. As the antenna moves off the target path, the speaker volume decreases and the *Bar Graph* [11] opens. Use the *Bar Graph* [11] and the numeric *Signal Strength* [10] value to locate the exact target path.

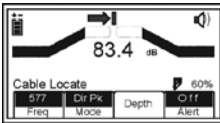

Left of Target Path

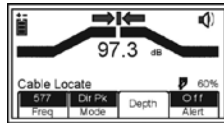

Directly Over Target Path

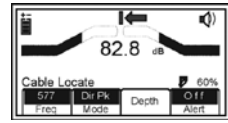

Right of Target Path

Once the target path has been located, the arrows at the top of the display will indicate the location of the target path in relationship to the receiver.

**Note:** When field distortion (due to congestion) is affecting the receiver the left/right arrows may not coincide with the bar graph. Use the maximum numerical signal strength to target the cable or pipe.

## B. Directional Null (DirNull)

Locate/OK [5] + Cable/Pipe [SK] + Mode [SK] + DirNull [SK Toggle]

In DirNull mode, as the operator approaches the cable or pipe, the numerical *Signal Strength* [10] will increase then fall sharply as the receiver crosses the target cable or pipe. The *Bar Graph* [11] fills from both sides toward the middle and the receiver speaker volume decreases. As the antenna moves off the target path, the *Bar Graph* [11] opens, the *Signal Strength* [10] increases, and the speaker volume increases. Gain adjust is automatic in DirNull mode.

The center of the DirNull display provides a 'compass view' of the target path. An arrow will point toward the location of the cable/pipe in 45-degree steps. A solid line will appear over the cable/pipe, indicating its orientation to the receiver handle.

For example:

**Figure 1:** If the target path is to the right of the receiver, and running parallel to the operator, the right arrow will display.

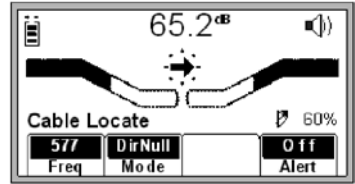

**Figure 2:** If the target path is to the left and in front of the operator (not running parallel to the receiver) the arrow will point toward the top left side of the display.

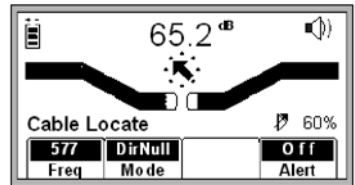

**Figure 3:** When the receiver crosses the target path, a solid line will appear, instead of arrows, indicating the target path and its orientation to the receiver handle.

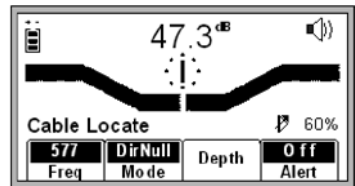

Before marking target path, always use Directional Peak (Dir Pk) or Special Peak (Spl Pk) mode to verify location.

### C. Special Peak (Spl Pk)

Locate/OK [5] + Cable/Pipe [SK] + Mode [SK] + Spl Pk [SK Toggle]

Special Peak Mode turns on only the peak antenna closest to the ground. Special Peak Mode is used in applications such as very deep cables or pipes, or when the signal is too weak for directional peak tracing.

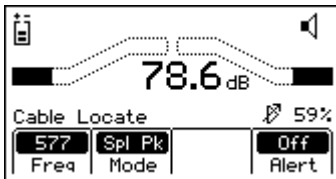

Left or Right of Target Path

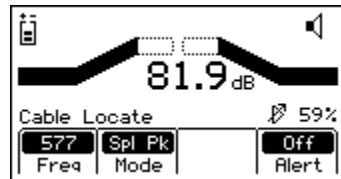

Directly Over Target Path

## D. Induction Peak (Ind Pk)

Locate/OK [5] + Cable/Pipe [SK] + Mode [SK] + Ind Pk [SK Toggle]

If you cannot make a direct connection, or use the 3M™ Dynatel™ Dyna-Coupler clamp to apply a locating signal on the target, use the induction method. This method uses the internal coil of the transmitter to generate a magnetic field.

The Induction Peak mode of the receiver is a mode in which the upper antenna of the receiver is tuned to minimize distortion from the magnetic field of the transmitter.

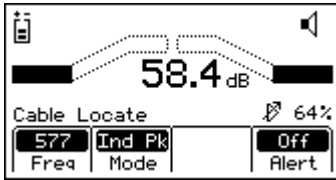

Left or Right of Target Path

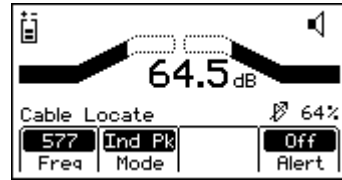

Directly Over Target Path

## E. Expanded Mode

When the third ring of the speaker icon is dotted or broken and 'xpnd' appears below the speaker icon as shown, the receiver is in "Expanded" mode. This mode is used for pinpointing a target cable or pipe. The area of response of the receiver narrows, allowing the locator to detect very small signal changes. Press the *Speaker Volume Control* [2] key to activate the "Expanded" mode.

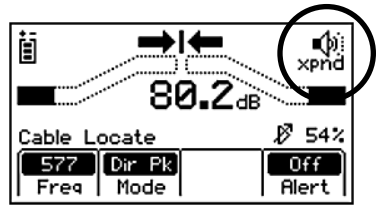

## 8. Depth and Current Estimate

Verifying the target path, depth and current can be helpful tools.

1. Pinpoint the cable or pipe being located.
2. Lower the tip of the receiver to the ground and press *Depth* [SK].

- The depth to the target cable or pipe is displayed in the units specified in the receiver set up menu. The bold current reading is a relative current measurement. This reading can be compared to the current reading that alternately flashes with the frequency on the transmitter to help identify the target cable/pipe. The highest relative current value will be the target cable/pipe and will compare closest to the transmitter relative current value. The milliamp reading is an actual current measurement.

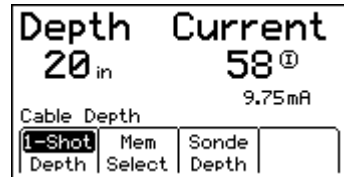

- There are two options for measuring depth. Live depth is a continuous measurement. 1-Shot Depth is an averaging of the depth reading over a short period of time. When in 1-Shot mode, the unit will average the depth reading for three seconds, and then display the result on the display. Press Depth [SK] to alternate between the two modes.

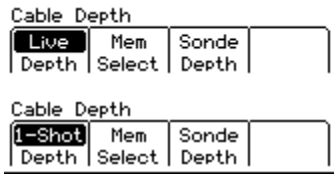

- Five depth readings can be saved with the time, date and relative current measurements.

- Pressing *Save* [SK] will place each entry in sequential order in memory (M1 - M5) until five readings have been stored. The unit will overwrite saved entries in excess of five, beginning with M1.

- Press *Clear All* [SK] to delete all stored depth information.

- The operator may select the memory location to store the depth readings by pressing Mem Select [SK]. When the preferred location appears on the display, press Save [SK]. The display and memory location will populate with the current information.

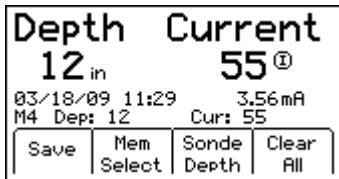

- Each memory location can be reviewed by pressing Mem Select [SK].

- Press *Locate/OK* [5] to return to Locate Mode.

## 9. Locating Frequencies

### A. Active Frequencies

Active frequencies are trace signals supplied by a 3M™ Dynatel™ 2200 Series Transmitter (577 Hz, 8 kHz, 33 kHz, or 200 kHz).

- Select the same frequency that the transmitter is generating.
- Press *Locate/OK* [5]
- Press *Cable/Pipe* [SK]
- Press *Freq* [SK]
- Press *Active* [SK Toggle] until the desired frequency is displayed in the soft key command [9] (“Active” 577, 8K, 33K or 200K)
- Press *Locate/OK* [5] to return to Locate mode.

## B. Power Frequencies

---

Power frequencies refer to 50 or 60 Hz signals, and their harmonics, that can be traced without the use of a transmitter.

**60:** Best for general locating of passive power.

**60H (high harmonic):** If the 60 choice appears to be responding slowly, or poorly, then 60H is the second choice for locating of passive power.

**60L (low harmonic):** Third choice for passive power locating. May be used when 60 or 60L is weak or erratic. 60L may be the best choice when locating primary power cables.

**120 Hz:** Used for locating rectified AC power signals, often found on pipelines using impressed current cathodic protection.

1. Press *Locate/OK* [5]
2. Press *Cable/Pipe* [SK]
3. Press *Freq* [SK]
4. Press *Power* [SK Toggle] until the desired frequency is displayed in the soft key command [9] (“Power” 60, 60L, 60H, or 120).
5. Press *Locate/OK* [5] to return to Locate mode.

All U.S. receivers default to 60 Hz.

To set the receiver to detect 50 Hz signals refer to *Enabling/Disabling Frequencies* section of this manual.

## C. Passive Frequencies

---

The receiver (without a 3M™ Dynatel™ 2200-Series Transmitter) can be used to detect some CATV cables (31.5 kHz). (A horizontal-scan television NTSC must be turned on to generate this frequency.)

1. Press *Locate/OK* [5]
2. Press *Cable/Pipe* [SK]
3. Press *Freq* [SK]
4. Press *Pasv* [SK Toggle]
5. Press *Locate/OK* [5] to return to Locate mode.

## D. Auxiliary Frequencies

---

Auxiliary frequencies are signals generated from remote location transmitters, or frequency generating transmitters.

1. Press *Locate/OK* [5]
2. Press *Cable/Pipe* [SK]
3. Press *Freq* [SK]



4. Press *Aux* [SK Toggle] until the desired frequency is displayed in the softkey command [9] (“Aux” 512, 560, 333 Hz, or user defined frequencies).
5. Press *Locate/OK* [5] to return to Locate mode.

## 10. Locating in Directional Peak Mode

The following are instructions for locating a buried pipe or cable using the direct connect method and the directional peak (Dir Pk) mode. Other methods of connection and tracing modes/features are explained in previous sections.

1. Insert the ground rod into the ground, perpendicular to the suspected target path.

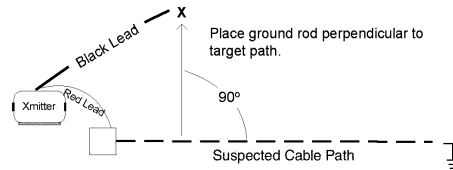

2. Remove the grounding from the near-end of the target cable/pipe.

**Note: Never connect or disconnect the transmitter when the unit is on.**

3. Connect the red lead of the transmitter to the shield, neutral, or deenergized target conductor.
4. Connect the black lead of the transmitter to the ground rod.
5. Perform a battery check by pressing and holding *off* [T-1].
6. Power on the transmitter by pressing *Ohms* [T-2] once for Ohm-meter mode. An indicator flag will be displayed above the ohms symbol ( $\Omega$ ) in the *Digital Display* [T-4].
  - a. A solid tone from the transmitter indicates a complete circuit with a good ground.
  - b. A beeping tone from the transmitter indicates a usable ground. An attempt should be made to improve the ground.
  - c. No tone from the transmitter indicates a poor, or no ground. The transmitter will display ‘OL’ in this instance. An attempt should be made to improve the ground. Verify that the far end is grounded.
7. Press *Trace* [T-3] to set the transmitter to Trace mode.
8. Select a frequency on the transmitter by pressing *Trace* [T-3]. The unit will cycle through the available frequencies (577, 8K, 33K, 200K, and ALL).
9. Press *On/Off (Power)* [1] to power on the receiver.
10. Press *Locate/OK* [5].
11. Press *Cable/Pipe* [SK].

12. Set the Frequency and mode of the receiver.

- Press *Freq* [SK]
- Select the same frequency on the receiver as the transmitter by pressing *Active* [SK Toggle].
- Press *Locate/OK* [5] to save the setting and return to locate mode.
- Press *Mode* [SK Toggle] until Dir Pk is displayed.



13. Stand away from the suspected target path and adjust the *Gain* [4] down until the bar graph opens completely.

14. Walk in a wide circle with your back toward the transmitter (about 10 to 15 feet (3–4.5 m) away).

- Watch the receiver display and listen to the signal. Take note of where the receiver detects the strongest Signal Strength [10].
- The bar graph will close when the unit detects a signal, and the arrows will reverse.
- Adjust the Gain [4] down if the bar graph closes completely.

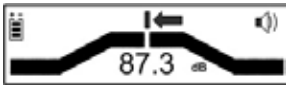

- The Signal Strength [10] numbers on the display will change with the signal strength (smaller, as you walk away from the target path; larger, as you approach the target path).
- Make a complete circle around the transmitter. Return to each point in the circle that the receiver detected.

15. Measure the depth and current of each point to identify the target path. The depth of the target path should be as expected and the relative current should compare to the relative current that is alternately flashing with the frequency value on the transmitter.

**Note: The relative current reading will decrease steadily as the locator moves away from the transmitter. When using higher frequencies, this decline is more evident.**

- Adjust the gain so that the bar graph responds to the target path (open when off path, almost completely closed when directly over target).
- Trace the cable/pipe at a slow walk while moving the receiver in a side-to-side motion, keeping the receiver perpendicular to the ground.
- Measure the depth and current occasionally to verify target path.

**Note: In order to measure the depth and current accurately, the operator must pinpoint the target pipe or cable, and the receiver handle should be in-line with the target path.**

- While in Dir Pk mode, find the highest Signal Strength [10].
- Lower the tip of the receiver to the ground. Twist the receiver left and right while watching the signal strength.
- When the highest Signal Strength [10] reading is displayed, the handle of the receiver is in line with the target pipe or cable.

Occasionally, a signal will appear on adjacent cables or pipes. Compare the relative and actual current readings (value that is under the relative current value and in mA units) over each path to help determine the target path. Current readings will be significantly less on the adjacent cable compared to the target path.

19. As tracing proceeds, remember that the most powerful signal is near the transmitter. As the receiver gets farther away from the transmitter the *Signal Strength* [10] decreases. It may be necessary to readjust the gain as needed to ensure that there is adequate signal for the receiver to operate. Press the *Gain* [4] up or down when the *Bar Graph* [11] is no longer visible (too little signal) or when the *Bar Graph* [11] is closed (too much signal).
20. Trace the path until you reach a logical termination point (i.e.: terminal, meter, cabinet, etc).

## 11. Locating Active Duct Probes (Sondes)

1. Press On/Off [1] on the receiver.
2. Press *Locate/OK* [5].
3. Press *Cable/Pipe* [SK].
4. Press *Mode* [SK Toggle] to select Special Peak (Spl Pk).
5. Press *Freq* [SK].
6. Press *Active* [SK Toggle] to select the 33kHz frequency (for a 33 kHz Sonde or Active Duct Probe (ADP)).
7. Press *Locate/OK* [5].
8. With the receiver handle perpendicular to the conduit path, locate the ADP position by moving along the path until the strongest signal is found. Adjust *Gain* [4] up or down when the bar graph remains either fully open or fully closed.
9. Refer to the ADP operating instructions for further information.

### A. Determining ADP Depth

1. Place the tip of the receiver on the ground directly above the located ADP position.
2. Maintain the handle orientation perpendicular to the target path.
3. Press *Depth* [SK] in the Cable Locate display.

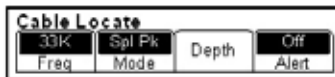

4. Press *Sonde Depth* [SK] to read ADP Depth
  - The depth to the ADP is displayed in units, as specified in the receiver set up menu.
  - Five Sonde depth readings can be saved with the time and date measured. Press Mem Select [SK] after the Sonde depth displays.
  - Press Mem Select [SK] to select a specific memory location (M1-M5) or select Save [SK]. Save [SK] will place each entry in sequential order in memory (M1–M5) until five readings have been stored. The unit will overwrite saved entries in excess of five, beginning with M1.

Cable Depth			
1-Shot Depth	Mem Select	Sonde Depth	

<b>Sonde depth</b> <b>28</b> in			
M5 Snd: 28 03/18/09 12:25			
Save	Mem Select	Cable Depth	Clear All

5. Press *Clear All* [SK] to delete all saved depth readings.
6. Press *Mem Select* [SK] to select the memory location to store the depth readings.
7. When the preferred location appears on the display, press *Save* [SK]. The display and memory location will populate with the current information.
8. Each memory location can be reviewed by pressing *Mem Select* [SK].
9. Press *Cable Depth* [SK] to switch to the cable depth display, or *Locate/OK* [5] to return to Locate Mode.

**Note:** During a depth measurement, the display will exhibit ‘- -’ when the received signal is too low, too high or erratic.

## 12. Locating Buried Sheath Faults and Earth Return Faults

(3M™ Dynatel™ Models 2273M and 2273M-iD only)

**Note:** Remove (disconnect) both the near-end and far-end grounding from the test section. Fault location will not work unless the near-end and far-end grounds are disconnected.

**Note:** This method only works on direct buried cables/conductors. It will not work if the cables/conductors are faulted inside of a conduit, such as a PVC conduit.

### A. Transmitter Setup

**Note:** Do not make any connections while the transmitter is on.

1. Attach the red clip to the earth-faulted conductor of the cable or conductor under test.
2. Place the ground rod behind the transmitter and in parallel with the target path.
3. Connect the black clip to the ground rod behind the transmitter and in parallel with the target path.
4. Press and hold *off* [T-1] to perform a battery test.

5. Press on: *Ohm-meter/Fault Locate/Tone* [T-2] to turn the transmitter on and place the transmitter in Ohm-meter mode.
  - The resistance of the fault will be displayed in ohms on the transmitter Digital Display [T-4].
  - Resistance less than  $50\text{K}\Omega$  = Significant fault exists
  - Resistance  $50\text{K}\Omega$  to  $1.0\text{M}\Omega$  = High resistance fault exists (May or may not cause problems yet, but gets worse with time.)
  - Resistance greater than  $1.0\text{M}\Omega$  = No significant fault exists

**Note: The fault locating limit is  $2.0\text{M}\Omega$ , although the transmitter's ohm-meter mode can display a fault resistance up to  $10\text{M}\Omega$ .**

- Note: The fault locating limit is  $2.0\text{M}\Omega$ , although the transmitter's ohm-meter mode can display a fault resistance up to  $10\text{M}\Omega$ .
6. Press on: *Ohm-meter/Fault Locate/Tone* [T-2] again, to select Fault Locate mode.
    - The Indicator Flag will turn on under the fault icon in the Digital Display [T-4] (as shown in the illustration below)



## B. Pinpointing the Buried Fault

1. Connect the 3M™ Dynatel™ Earth Contact Frame (also known as an A-Frame) to the *External Jack* [14] ([13] on 2250M) of the receiver using the earth frame cable (4 ft. (1.2m) cable).
2. Press *On/Off (Power)* [1] to power on the receiver. The receiver display screen will display "*Fault Calibrating*" for about 5 seconds.
3. Press *Locate/OK* [5].
4. Press *Fault* [SK] to select Fault mode.
5. Hold the receiver in one hand and the Earth Contact Frame in the other with the solid green-banded leg of the frame toward the test section. Near the location of the ground rod (about one Earth Contact Frame width away from the ground rod, slightly to the side and towards the faulted cable), insert the Earth Contact Frame probes fully into the ground in line with the target path.
6. Press *Ref* [SK] to record the fault level reference signal. The signal level will be recorded in the box above *Ref* [SK] on the display. This reference indicates the *Signal Strength* [10] level at the ground rod. When the operator reaches the major fault location, the *Signal Strength* [10] indicated on the receiver will be very close (within 12dB) to this reference signal level.

- Continue along the cable path, re-inserting the Earth Contact Frame probes every few steps while watching the receiver bar graph. The bar graph on the receiver will fill toward the right side of the display (green *Fault Finding Direction Indicator* [13] (See illustration below)), indicating that the fault is ahead of the operator (in the direction of the green-banded leg of the Earth Contact Frame).

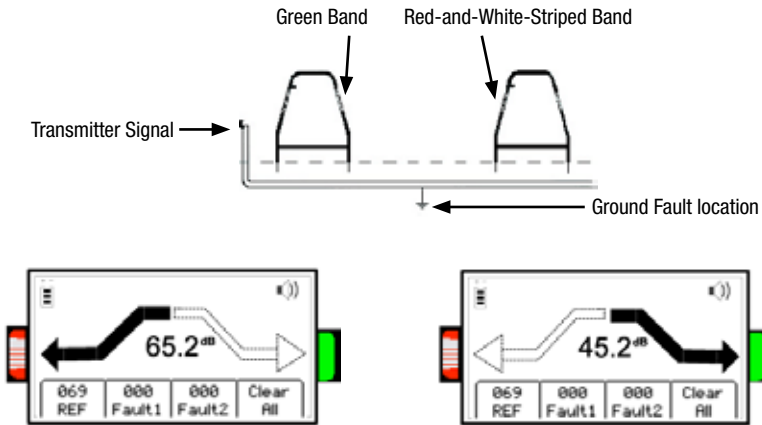

Move in direction of red-banded leg of Earth Contact Frame.

Move in direction of green-banded leg of Earth Contact Frame.

- When the bar graph fills toward the left (red-and-white-striped *Fault Finding Direction Indicator* [13] (See illustration above)) side of the display, the fault has been passed and is now behind the operator. Move back, inserting the Earth Contact Frame every few inches, until the arrows alternate back to green. Mark the point beneath the center of the frame. Turn the Earth Contact Frame 90 degrees and insert into the ground over the previously marked point. Move the Earth Contact Frame to the left and right (following the directions of the green and red indicator arrows). When the arrows reverse a third time, turn the Earth Contact Frame 90 degrees again. Pinpoint the fault by moving the Earth Contact Frame in the direction of the green and red arrows. The fault is located beneath the center of the Earth Contact Frame when the arrows change from one side to the other this time.
- To verify the fault location, insert the Earth Contact Frame's red-and-white-striped probe directly on the spot identified above. Pivot the Earth Contact Frame in a circle around the red-and-white-striped leg re-inserting the green-banded leg in the ground every few degrees of the circle (Figure 2). The arrow should always point toward the left (red) indicating that the fault is directly below the red-and-white-striped leg.

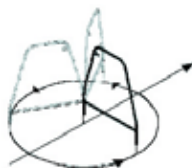

- After a fault is located and pinpointed, move the Earth Contact Frame about one Earth Contact Frame width away from the fault and insert it in the ground with the green-banded leg towards the fault. Compare the numeric signal level with the fault level reference signal indicated in the lower left box labeled *Ref*. If the reading is within 12 dB of the reference signal, the operator has found the major fault. If the fault reading does not fall within 12 db of the reference signal reading, multiple faults may exist. The signal level of this secondary fault can be saved by pressing *Fault 1* [SK] or *Fault 2* [SK]. The fault with the highest reading will be the primary fault.

*Note: For additional information about locating buried sheath faults and earth return faults, please see the 3M™ publication Cable and Pipe Locating Techniques at [www.3M.com/dynatel](http://www.3M.com/dynatel).*

## 13. Locating 3M™ Electronic Markers and 3M™ iD Markers

(3M™ Dynatel™ Models 2250M-iD and 2273M-iD only)

### A. Enabling/Disabling Marker Types

Menu [6] + >>More [SK:4] + Setup [SK:6] + >>More [SK:6d] + Marker Type [SK:6f]

The unit will default with all markers enabled (✓).

- Press the up/down arrows [SK] to highlight a utility to enable or disable.
- Press *Enabl/Disabl* [SK].
  - Only the markers that are enabled (□) will be available in the locate mode.
- Press *Locate/OK* [5] to save settings or *Exit* [SK] to cancel.

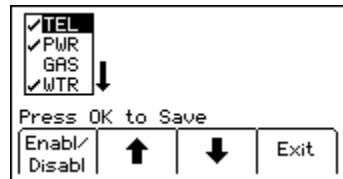

### B. Alert Mode

While tracing a cable or pipe, it is possible to search for markers.

- Press *Alert* [SK].
  - If the unit is in Dir Pk, DirNull or Ind Pk, a prompt will notify the operator that alert mode only functions in Special Peak (Spl Pk) mode.
- Press *Mode* [SK Toggle] for Spl Pk.
- Press *Alert On* [SK Toggle].

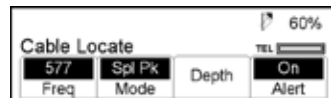
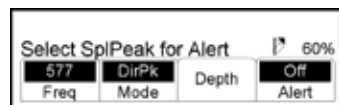

- The receiver display will add the Alert bar graph and the type of marker to the display with a prompt to adjust the marker gain.

4. Press the *Gain* [4] until only a small mark on the marker bar graph is visible.
5. Press *Locate/OK* [5] to save the marker gain setting.

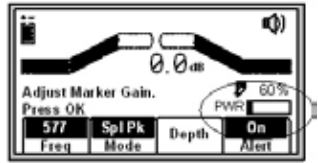

- The display will return to Special Peak Cable Locate / Alert On.
- If the selected type of utility marker is detected, a second audio tone will emit from the unit and the marker bar graph will fill. The marker utility will default to the last type of marker set in marker locate mode.

6. Press *Locate/OK* [5] + *Marker* [SK] + *Marker 1* [SK Toggle] to change the type of marker that the unit will detect in alert mode.
7. Press *Locate/OK* [5] and then *Cable/Pipe* [SK] to return to the locate mode with the newly selected marker type now visible on the display. Adjust the *Gain* [4] again (per Step 4 above) and then press *Locate/OK* [5].

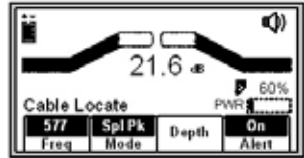

## C. Single Marker Locate

1. Press *Locate/OK* [5]
2. Press *Marker* [SK]
3. Press *Markr 1* [SK Toggle] to select desired utility.
4. *Markr 2* should be OFF.

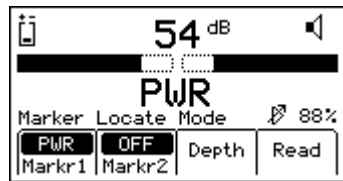

**Note:** Only the marker types enabled in the setup menu will be shown. (See *Enabling/Disabling Marker types, Section 13A*). When scanning for markers, the gain level [12] should be set high.

- When a marker is detected, adjust the Gain [4] down until the bar graph opens.
- The bar graph will close, the audio will be steady, and the Signal Strength will be maximum when the receiver detects a marker of the specified utility and has pinpointed its location.



## D. Dual Marker Locate

1. Press *Locate/OK* [5].
2. Press *Marker* [SK].
3. Press *MARKR 1* [SK Toggle] to select desired utility.
4. Press *MARKR 2* [SK Toggle] to select desired utility.

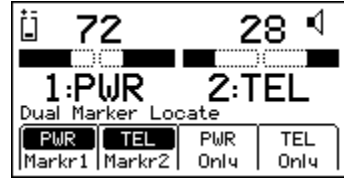

**Note:** Only the marker types enabled in the setup menu will be shown. (See *Enabling/Disabling Marker types, Section 13A*). When scanning for markers, the gain level [4] should be set high.

- The third and fourth soft key commands will populate with the types of utilities selected for Marker 1 and Marker 2.
5. Adjust the *Gain* [4] down until the bar graphs open.
    - The bar graph will close, the audio will increase, and the Signal Strength [10] will increase when the receiver detects a marker of the specified utility.
    - When one of the two markers is detected, press the “XXX Only” [SK] for the detected utility marker. (“XXX” represents the marker types selected. In the above example, PWR Only and TEL Only.)
    - The receiver will switch to Single Marker Locate in order to pinpoint the marker.
  6. Press *Markr 2* [SK Toggle] to return to Dual Marker Locate.

## E. iD Marker Depth

1. Lower the tip of the receiver to the ground over the pinpointed marker.
2. Press *Depth* [SK].
  - The receiver will examine the marker (Calculating, please wait...)
  - If the marker is a 3M™ Dynatel™ iD Marker, the receiver will display the depth of the marker, and its identification serial number.

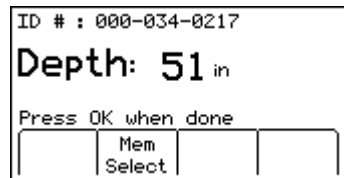
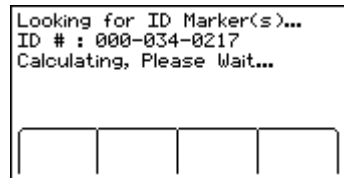

- To save the depth reading, press *Mem Select* [SK].

- Five depth readings can be saved with the time, date, and its identification number.
- Save [SK] will place each entry in sequential order in memory (M1 - M5) until five readings have been stored. The receiver will overwrite saved entries in excess of five, beginning with M1.

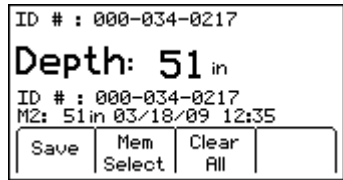

- Optional: Press *Clear All* [SK] to delete all stored depth information.
- Press *Mem Select* [SK] to select a specific memory location (M1–M5) to store the depth readings. When the preferred location appears on the display, press *Save* [SK]. The display and memory location will populate with the current information.
- Each memory location can be reviewed by pressing *Mem Select* [SK].
- Press *Locate/OK* [5] to return to Marker Locate Mode.

## F. Passive Electronic Marker (Non-iD) Depth

- Lower the tip of the receiver to the ground over the pinpointed marker.
- Press *Depth* [SK].
  - The receiver will examine the targeted marker.
  - The display will instruct the operator to raise the unit 6 inches (15.2 cm) from the ground.

**Note: This 6-inch (15.2 cm) rise must be exact for the depth reading to be accurate. A suggestion is to utilize a 6 inch (15.2 cm) piece of plastic pipe or wood as a spacer between the ground and the tip of the receiver for this precise measurement.**

- Raise the receiver 6 inches (15.2 cm). Press the *Depth* [SK] key again. The estimated depth of the marker from ground level will be displayed.
  - Five depth readings can be saved with the time and date.



- To access the memory locations, press *Mem Select* [SK].
  - Save [SK] will place each entry in sequential order in memory (M1–M5) until five readings have been stored. The receiver will overwrite saved entries in excess of five, beginning with M1.



- Optional: Press *Clear All* [SK] to delete all stored depth information.

6. Press *Mem Select* [SK] to select a specific memory location (M1–M5) to store the depth readings. When the preferred location appears on the display, press *Save* [SK]. The display and memory location will populate with the current information.
7. Each memory location can be reviewed by pressing *Mem Select* [SK Toggle].
8. Press *Locate/OK* [5] to return to Marker Locate Mode.

## 14. Creating/Editing Templates for 3M™ iD Markers

In the User Template display, the operator can create and modify templates for writing to iD markers. Note that the easiest way to create user templates is by using the 3M™ Dynatel™ PC Tool Kit software on a PC and then downloading them to a receiver via the RS232 *Serial Port* [15] ([13] on 2250M) on the receiver and the provided RS232 cable or RS232-to-USB adapter cable. The 3M™ Dynatel™ PC Tool Kit software is available free of charge at [www.3M.com/dynatel](http://www.3M.com/dynatel) under the Software section; 2550/2573/2250M/2273M/1420 Locator PC Tools xx.x.x (EXE xx.xMB).

### A. Creating New Templates

Menu [6] + Data/Templat [SK:2] + User Templat [SK:2c]

1. Select *Create New* by pressing the up/down arrows [SK].
2. Press *View/Edit* [SK].

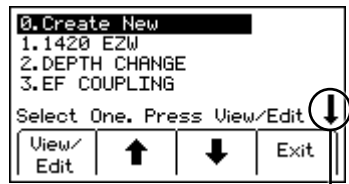

This arrow indicates that additional viewable information is available by pressing the down arrow [SK].

3. Name the template.
4. Press *Modify* [SK] to manually enter the name of the template.



5. Select *UserEdit*.
6. Press *Locate/OK* [5]



7. Move the boxed cursor by pressing the left/right arrows [SK], or up/down arrow [SK], to move the cursor up or down.
8. Press *Select* [SK] to enter the alphanumeric character.
  - Entry will appear at the top of the display.
9. Press *Locate/OK* [5] when entry is complete.
10. Press *Exit* [SK] to cancel.

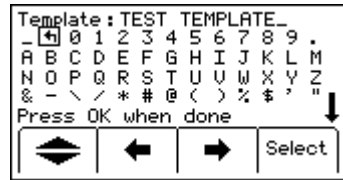

**Note:** To clear the previous field entry, select the 'back arrow' with the cursor and delete the previous entry.

11. Navigate through the fields by pressing the left/right arrows [SK].
12. Press *Modify* [SK] to populate the highlighted field.



13. When modifying the Labels (left hand side of template information) there are three options for editing that are presented:
  - a. UserEdit
  - b. Choosing one of the common (compressed) terms from the available list of terms.
  - c. Del Row (delete row)



14. When modifying the Descriptions (right hand side of template information) there are four options for editing that are presented:
  - a. UserEdit
  - b. Delete Row
  - c. Last 10 UserEdits
  - d. Show All - lists common (compressed) terms



15. Populate as many fields as possible from the drop-down list of common (compressed) terms available to conserve marker memory space, or choose *UserEdit* if a term is not found to meet the user's requirements. Select term by pressing the up/down arrows [SK] and press *Locate/OK* [5].

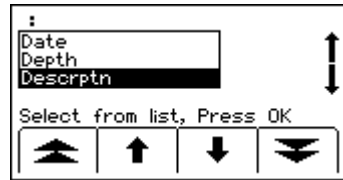

16. Navigate to the next field by pressing the left/right arrow [SK].



17. Press *Modify* [SK] to populate the highlighted field.
18. Populate additional fields, as needed, using the above procedure steps 16 and 17. Templates are limited to six Label and six Description fields (256 bits of data total).

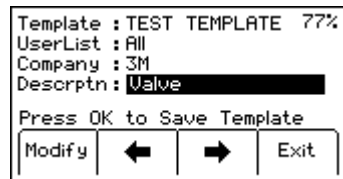

19. When the template is complete, save the template by pressing *Locate/OK* [5].



## B. Editing Templates

The operator can select an existing template and make changes to it in the same manner described in *Creating Templates*. The following save screen will be displayed.

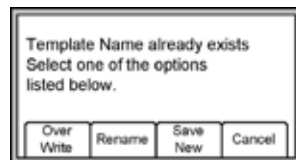

**Over Write:** Saves all modifications that have been made to the original template.

**Rename:** Overwrites the old template with the new name and all modifications. Display will return to the template name field. Modify the name of the template and press *Locate/OK* [5] to save.

**Save New:** Creates a new template containing all information. Original template remains unchanged. Display will return to the template name field. Modify the name of the template and press *Locate/OK* [5] to save.

**Cancel:** Clears all modifications made to any unsaved template.

## 15. Writing iD Markers

The Write Mode enables the user to write information into 3M™ iD Markers. It is also possible to edit the information to be written into an iD Marker.

Menu [6] + Write Mode [SK:1]

1. Select a template from the list on the display to be written into the marker by pressing the up/down arrows [SK] to highlight the preferred template. 'Last Written/Read' is the most recent data that was written to a marker by the receiver.

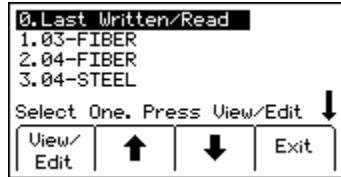

2. Press *View/Edit* [SK].
  - The selected template will be displayed. The arrow on the right side of the display indicates there is more information than can be displayed on the display (scroll down by pressing the down arrow [SK]).

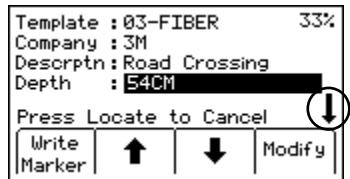

3. Enter user information that will be written to this marker. (See *Modifying Marker Data to be Written*, Section 15A)
4. Verify that all information is correct.
5. Press *Write Marker* [SK].
6. Select type of marker to be written; *Marker* [SK Toggle].
7. Hold the receiver directly over the top of the marker. The receiver should be within the following maximum writing ranges for each of the different iD Marker formats;
  - Near Surface iD Marker = 6 in (15 cm) maximum
  - Ball iD Marker = 12 in (30 cm) maximum
  - Full Range iD Marker = 24 in (61 cm) maximum
8. Press *Start Write* [SK].

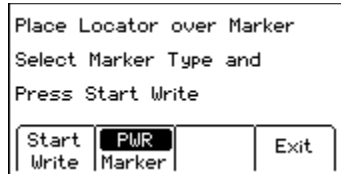

- The receiver will ask if the user wants to permanently lock the marker data.

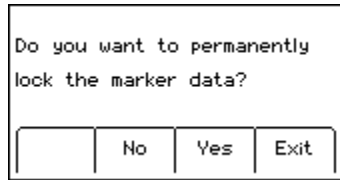

9. Select *No* [SK] or *Yes* [SK]. The receiver will write the data to the marker. (See note below.)

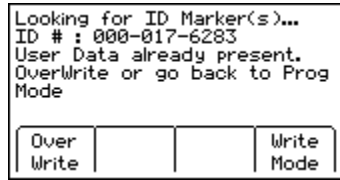

10. After writing to the iD Marker is completed, the following will be displayed.



**Note:** Once the marker data has been locked, the information contained on the marker is **PERMANENT**. Choosing to permanently lock the marker data is irreversible. Once the data is locked it can not be overwritten. Assure that the data that is being written is correct before proceeding.

## A. Modifying Marker Data to be Written

To alter the information to be written into the marker

1. Press *Menu* [6] + *Write Mode* [SK:1].
2. Select a template from the list on the display to be written into the marker by pressing the up/down arrows [SK] to highlight the preferred template. 'Last Written/Read' is the most recent data that was written to a marker by the receiver.
3. Press *View/Edit* [SK].
4. Press the up/down arrows [SK] to highlight the information to change.

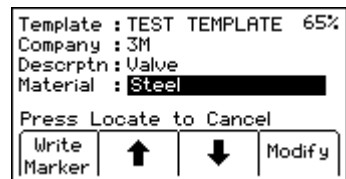

5. Press *Modify* [SK]. The percentage displayed in the upper right portion of the display indicates the remaining memory available on the marker.

- The operator may select *User Edit* in order to ‘type’ the modification, or *Delete Row* to remove the entire row from the template, or select *Show All* to display a list of common compressed terms.



**Note:** *Using a common compressed term requires less memory in the marker.*

- Select an option from the list by pressing the up/down arrows [SK]. Press *Locate/OK* [5].
- If *User Edit* is selected, the following display will appear.
- Move the boxed cursor to the ‘back arrow’ and press *Select* [SK] to delete the entry to be modified.
- Move the boxed cursor by pressing the left/right arrows [SK], or the Up/ Down Arrow [SK], to move the cursor to the next row.

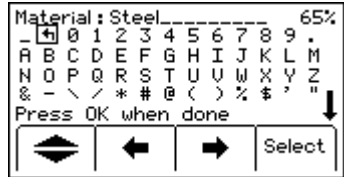

- Press *Select* [SK] to enter the alphanumeric character.
  - Entry will appear at the top of the display.
- Press *Locate/OK* [5] when entry is complete.

- If *Show All* is selected, the following display will appear.
- Select a common compressed term from the list by pressing the up/down arrows [SK].
- Press *Locate/OK* [5]. The modification will automatically populate the marker template.

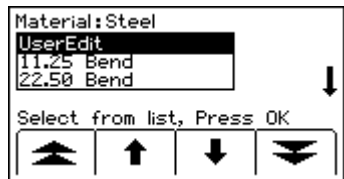

## 16. Reading iD Markers

The operator can retrieve the data from the iD marker by pressing Read [SK] on the Marker Locate display.

The receiver tip should be lowered to the ground to reach maximum read depth.

If more than one 3M™ iD Marker of the same utility is detected, the receiver will read the first marker and display the data from the marker.



The fourth yellow command key will be labeled “Read Next”. Press this key to extract the data from the other marker.

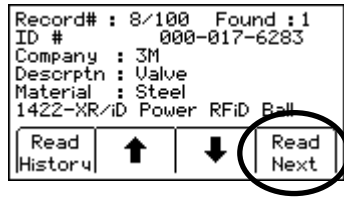

All the information retrieved from the marker, including the date and time read, is saved into the ‘Read History’ file of the receiver. If a hand-held GPS device is used in conjunction with the receiver, coordinates can be saved into the Read History also. (See *Reviewing Marker Read/Write History*, Section 17)

## 17. Reviewing Marker Read/Write History

### A. Read History

The Read History mode is a historical file of all information that has been read from targeted markers (100 memory locations).

Menu [6] + Data/Templat [SK:2] + Read History [SK:2a]

The Read History screen displays the date and time that each marker was read, and its unique identification number.

1. Select the marker data to be viewed by pressing the up/down arrows [SK]
2. Press *Marker Details* [SK] to view all data that was retrieved from the marker.
3. Press *Read History* [SK] to return to list or press *Exit* [SK] to return to Data/Template review display.

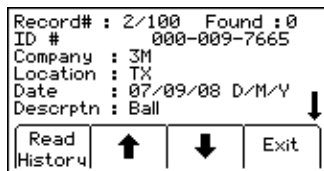
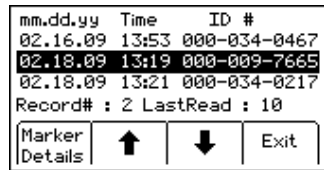

## B. Write History [SK]

---

Menu [6] + Data Templat [SK:2] + Write History [SK:2b]

1. Select the marker data to be viewed by pressing the up/down arrows [SK].
2. Press *Write Details* [SK] to view all data that was sent to the marker.
3. Press *Write History* [SK] to return to the list of written data.
4. Press *Exit* [SK] to return to Data/Template review display.

mm.dd.yy	Time	ID #
02.18.09	09:56	000-011-7600
02.18.09	13:23	000-034-0217
02.19.09	14:17	000-034-0012

Record# : 78

Write Details	↑	↓	Exit
------------------	---	---	------

For additional information concerning writing to 3M™ iD Markers, refer to [www.3M.com/dynatel](http://www.3M.com/dynatel) - *Instruction Manual M-Series Locator PC Tools*.

# 18. GPS Operation

## A. Activation Key

---

To activate the GPS compatibility in the receiver, an activation key must be entered into the receiver. You must have at least version 14.0 of the receiver software. For the receiver to transmit information to the GPS device for use in GIS mapping applications (see *F. Sending iD Marker Data to GPS (Capture-Transmit Mode / Mode 2)*), the hardware version must be 5.0 or higher. (See *B. Serial Number and Software Version*.)

The software upgrade and activation key can be obtained from the website [www.3M.com/dynatel](http://www.3M.com/dynatel) for no charge. You will be asked to enter the serial number of the receiver and a few other informational items in order to receive the GPS activation key.

Upgrade the software of the receiver using the desktop software, if necessary, using: 3M™ Dynatel™ PC Tool Kit. Enter the GPS activation key on the receiver (See *Inputting the GPS Activation Key*, Section 18C).

## B. Serial Number and Software Version

---

Menu [6] + >>More [SK:4] + Self Test [SK:7]

The model number, software version, hardware version, and serial number of the receiver are available on the Self Test display. The Self Test Mode can also be run from this screen by pressing Run [SK].

## C. Inputting the GPS Activation Key

---

Menu [6] + COM Setup [SK:3]

Initially, when the COM key is pressed, and an attempt is made to enable any selection other than *PC*, the display below will appear and you will be prompted to input the activation key that you have obtained from the website. This will have to be performed only one time to enable the GPS interface.

1. Move the selector box left or right by pressing the arrow keys [SK].
2. Press *Select* [SK] to enter each number.
3. Press *Locate/OK* [5] to activate.

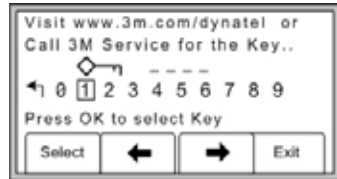

## D. Communicating with the GPS Device

Menu [6] + COM Setup [SK:3]

After the GPS device interface has been activated, the Com Setup [SK:3] display will toggle through several options to configure the Serial Port [15] ([14] on 2250M) of the receiver (depending on the application, or capabilities of the GPS device). Select from the following options.

**NMEA** – The Serial Port is configured to receive NMEA signals from a GPS device (4800 Baud Rate). (Capture Mode/Mode 1)

**GIS** – The Serial Port is configured to send data to and receive data from a GPS device that has GIS mapping capabilities. (Capture/Transmit Mode/ Mode2)

**PC** – The Serial Port is configured to communicate with a computer for the Dynatel PC Tool Kit application

**PDA** – The Serial Port is configured to only send information if the GPS device only has the ability to receive information.

**Log Prompt = On** – Before the receiver returns to locate mode, a verification screen will appear on the receiver display asking if you want to log this point. Press *Locate/OK* [5] to send data to the GPS device.

**Log Prompt = Off** – When the receiver returns to locate mode, the locate information will be sent automatically to the GPS device.

## E. Capturing the GPS Coordinates (Capture Mode / Mode 1)

Menu [6] + COM Setup [SK:3] + NMEA

If the GPS device is not configured properly, there is an error communicating with the receiver, or the GPS has not acquired enough satellites to pinpoint the location, the receiver will display the message “Insert External Device”.

When the receiver is communicating with a GPS device, the LAT and LONG coordinates received from the GPS device will appear on the marker locate display.

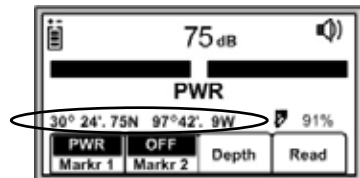

1. Locate a marker (See 13.C, *Single Marker Locating*.)
2. Press *Read* [SK]

The information from the iD marker, as well as the GPS coordinates, will display on the receiver display. This information is saved automatically in the Read Marker History. (See 17. *Reviewing Marker Read/Write History*.)

If the marker is a passive marker (rather than iD) the receiver will display “No iD Marker Found”. The GPS coordinates of the attempt to read the non-iD marker are stored in the Read Marker History as serial number # 0000-0000-0000. The marker details will indicate “not an iD marker”, but will display the GPS coordinates.

## **F. Sending iD Marker Data to GPS (Capture-Transmit Mode / Mode 2)**

---

Menu [6] + COM Setup [SK:3] + GIS

Receivers that have marker locating capability (indicated by ‘iD’ in the model number) can be configured to send 3M™ iD Marker data directly to some GPS devices. When an iD marker is located and read, the information read from the iD marker with feature and attribute data is sent to the GPS device and is stamped with latitude, longitude and date/time data. The data acquired during this logging process can be uploaded to GIS mapping software. For more information and detailed instructions pertaining to specific GPS devices, refer to *www.3M.com/dynatel* for GPS instruction sheet.

## **G. Path Mapping with GPS**

---

The M-Series cable and pipe locators are compatible with hand-held GPS devices and now have the ability to map the path of underground target facilities. While measuring the depth to the target, the technician can automatically log the coordinates of the path to the GPS device. These logged points contain the Trace template that can have valuable information regarding the facility (owner, utility, size, etc.) and the method used to find the path (frequency, current, and measured depth).

In order to transmit the path information to a GPS device, the GPS has to have the ability to accept information on one of its com ports at 4800 Baud. Using the manual supplied with the GPS device, configure the com port of the GPS to communicate with the receiver.

If ArcPad™ is the mapping software on the mobile device, download the 3M software application script from the website: *www.3M.com/dynatel*

With 3M’s ArcPad™ application installed, the receiver will send the path information (locate frequency, depth, current, and trace template information) into the software program as a logged point and can be saved as a .shp file.

### **1. Creating Trace Templates**

The easiest way to create a Trace template is using the Dynatel PC Tools software. The 3M™ Dynatel™ PC Tools software is available free of charge at *www.3M.com/dynatel* under the Software section; 2550/2573/2250M/2273M/1420 Locator PC Tools xx.x.x (EXE xx.xMB).

- Create a TRACE template.
- Save and download the template to the receiver.

Up to four Trace Templates can be stored on the Receiver.

Each Trace template is limited to 132 user editable characters.

The trace template appears in table format: two columns with six lines.

The first column is limited to 8 characters and the second column is limited to 14 characters. In addition to the 132 character table, the receiver will send a sequence number, the frequency, the measured depth of the conductor, and the current to the GPS.

## 2. Select Com Port Setting

Menu [6] + Com [SK:3] + GIS [SK] (or PDA [SK])

If the GPS device has the ability to send NMEA coordinates on its com port and has the ability to receive information at 4800 baud, set the receiver's com port to GIS.

If the GPS device only has the ability to receive information, set the com port of the receiver to PDA mode.

**Log Prompt = On:** Before the receiver returns to locate mode, a verification display will display on the receiver with the trace template information that will be sent to the GPS device. This information can be modified and confirmed. Press OK to send to the GPS device.

**Log Prompt = Off:** When the receiver returns to locate mode, the trace template and locate information will be sent automatically to the GPS device.

## 3. Sending Path Information to GPS Device

1. Establish communication with the GPS device.
2. Set COM port on receiver.
3. Locate target utility.
4. Measure depth to target utility.
  - If Log prompt is activated, when the Locate/OK [5] button is pressed (or after a five second delay), a display will appear that displays the path information.
5. Press *Locate/OK* [5] to send the information to the GPS device, or *Exit* to abort the exchange.

For more information refer to the software release notes at [www.3M.com/dynatel](http://www.3M.com/dynatel)

# 19. Additional Applications

## A. Aerial Faults (Toning)

---

### 1. Transmitter Setup

1. Connect the transmitter (based on type of fault) as described in Connection Diagrams in the following section.
2. Press and hold *off* [T-1] to perform a battery test.
3. Press *on: Ohm-meter/Fault Locate/Tone* [T-2] to turn the Transmitter on and to verify the fault.
4. Press *on: Ohm-meter/Fault Locate/Tone* [T-2] twice more to select the Tone mode.

5. The *Digital Display* [T-4] will alternately flash between 577 and 200K.
6. Press *Output Level* [T-5] for high or maximum output level.

## 2. Receiver Setup

1. Press *On/Off (Power)* [T-1] to turn the receiver on.
2. Press *Locate/OK* [5]
3. Press *Tone/Ext* [SK] to select Tone mode.
4. Press *Freq* [SK Toggle] to select 577Hz.
5. Connect a toning coil to the receiver *External Jack* [14] ([13] on 2250M).
6. Move the toning coil along the cable and find a peak signal, then press *Gain* [4] down to adjust the receiver gain.
7. Press *Speaker Volume Control (Spkr/Xpnd)* [2] to adjust the speaker volume as needed.
8. Follow the cable with the toning coil.
  - When the receiver detects a short, cross, or ground fault (Connection Diagram Figures #1, #2, or #3), the audio and Signal Strength [10] will stop or drop off sharply.
  - When the receiver detects a split (Connection Diagram Figure #4) the audio and signal strength will increase significantly.
  - When verifying a split (Connection Diagram Figure #5) the audio and signal strength will decrease after the toning coil has passed the split.

## 3. Connection Diagrams

**Short:** Red clip to Tip; Black clip to ring.

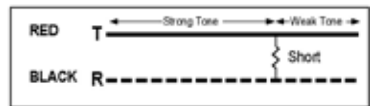

Figure 1

**Cross:** Red clip to the crossed conductor of one pair; Black clip to the crossed conductor of the other pair.

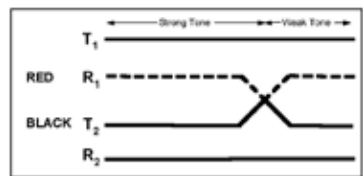

Figure 2

**Ground:** Red clip to the faulted conductor;  
Black clip to ground.



Figure 3

**Split:** Red clip to Tip of Pair 1; Black clip to Ring of Pair 1.

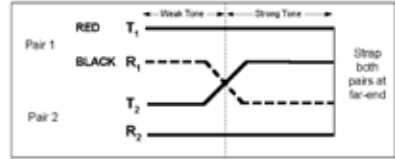

Figure 4

**Verify Split:** Red clip to good conductor of Pair 1; Black clip to split conductor of Pair 2

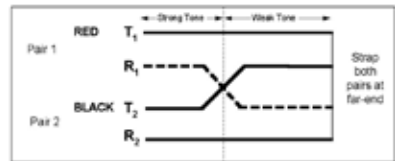

Figure 5

## B. Cable Identification

### 1. Transmitter Setup

1. Connect the 3M™ Dynatel™ Dyna-Coupler to the Transmitter *Output Jack* [T-6] using the coupler cable.

**Note:** *Cable Identification requires two Dyna-Couplers: one at the Transmitter and one at the Receiver.*

2. Clamp the Dyna-Coupler around the cable or both the tip and ring of a pair. **Make sure the jaws fully close.**
3. Press and hold *off* [T-1] to perform a battery check.
4. Press *on: Ohm-meter/Fault Locate/Tone* [T-2] three times to set the transmitter to Tone mode.
  - The indicator flag will light in the Digital Display [T-4] under the Tone icon.
5. Press *Output Level* [T-5] for high or maximum output power level.
  - The indicator flag will light in the Digital Display [T-4] above the Output Level icon when in high output power level and flash when in maximum output power level.
  - The Digital Display [T-4] will alternately flash between 577 and 200K.

### 2. Receiver Setup

1. Press *On/Off (Power)* [1] to power the receiver on.

2. Press *Locate/OK* [5].
3. Press *Tone/Ext* [SK] to select Tone mode.
4. Connect a second coupler to the receiver's *External Jack* [14] ([13] on 2250M) using the Earth Contact Frame cable (4 ft. (1.2 m) cable) or another coupler cable.
5. Press *Freq* [SK Toggle] to select the highest transmitter frequency (200K).
6. Check the first cable in the group by clamping the coupler around the cable. **Make sure the jaws fully close.**
7. Press *Gain* [4] down and observe the numerical *Signal Strength* [10].
8. Remember the signal strength value and continue by clamping the coupler around the next cable in the group.
  - If the Signal Strength [10] is greater than the previous observation, press Gain [4] down.
  - If the Signal Strength [10] is less than before, ignore it.
  - After checking all the cables in the group, the cable with the highest Signal Strength [10] reading is the target cable.

## 20. Help Mode

Menu [6] + >>More [SK:4] + Help [SK:8]

The help display contains basic information about the unit and its operation. It is designed to be a quick reference guide.

- Press the double up/down arrows [SK] to navigate between sections.
  - The single up/down arrows [SK] will scroll the display line by line.

## 21. 3M™ Dynatel™ PC Tool Kit and Locator Software Upgrades

Locator software upgrades are periodically released and can be downloaded, free of charge, at [www.3M.com/dynatel](http://www.3M.com/dynatel). Located under the Software section, the software is titled 2550/2573/2250M/2273M/1420 *Locator PC Tools xx.x.x (EXE xx.xMB)*. Once downloaded to your PC, double click the file and an auto-installer will install the PC Tool desktop software. Double click the *Dynatel PC Tool Kit* icon on the desktop. Using the provided RS232 cable, or RS232-to-USB adapter cable, connect the *Serial Port* [15] ([14] on the 2250M) on the receiver to the PC and power the receiver on. Click the *Upgrade Software* button in PC Tools to begin upgrade. Do not disconnect or turn off the receiver while the upgrade is in progress. Wait until the software indicates that the installation was successful. This will take approximately 6 to 7 minutes to complete.

The *Dynatel PC Tool Kit* provides the user an excellent interface between the receiver and a PC. This software utility provides the tools by which the user can:

- Upgrade the receiver to the latest software revision



- Program one or multiple receivers to best suit specific user configurations
- Load an alternate language into the receiver
- Utilize the 3M™ iD Marker utility to:
  - Create templates for writing data to iD markers, or create Trace Templates for GPS path tracing when connected to a GPS device.
  - Download iD marker data that has been written or read by the receiver for documentation databases.

Embedded in the desktop software is the most current software for the receiver, which affords the user the option of upgrading the unit without returning the unit to the 3M Service and Repair Center.

Please refer to the operating instructions included with the software.

## 22. Self Test Of Receiver

Menu [6] + >>More [SK:4] + Self Test [SK:7]

This operation performs a self-test on the receiver.

The receiver will display current information about the unit (model number, serial number, software revision, and hardware revision).

1. Press *Run* [SK] to start the self test.
  - A status bar will appear while the self test is running.
  - Results will appear on the display when the test is complete.
  - Press *Exit* [SK] to return to the Menu.

## 23. Product Description And Optional Accessories

### A. Product Description

---

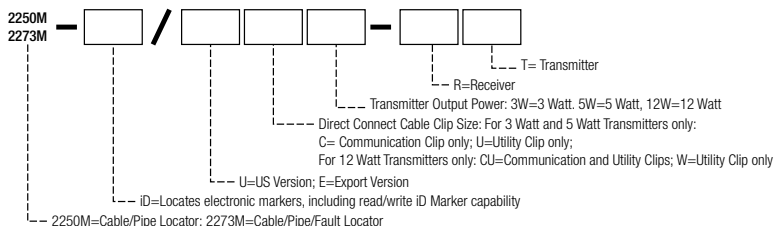

#### Example: 2273M-iD/UCU12W-RT

**Description:** 2273M Cable/Pipe/Fault Locator / iD capability; U.S. version; Communication and Utility direct connect cables (clips); 12-Watt Transmitter; Receiver and Transmitter included.

## B. Standard Configurations

Standard Packages	2250M	2250M-ID	2273M	2273M-ID	Part Number
Transmitter	•	•			2250; 3, 5 or 12 Watt
			•	•	2273; 3, 5 or 12 Watt
Receiver w/o EMS	•				2250M-UR
			•		2273M-UR
Receiver w/EMS		•			2250M-ID/UR
				•	2273M-ID/UR
Ground Rod	•	•	•	•	8006
Dyna-Coupler Kit (3" [76 mm] Dyna-Coupler, Coupler Cable & Pouch)	•	•	•	•	3019
Direct Connect Cables	•	•	•	•	2876 (Utility - 10' [3 m])
					9012 (Communication - 5' [1.5 m])
Earth Contact Frame			•	•	3014
Earth Contact Frame Cable			•	•	9026

## C. Optional 3M™ Dynatel™ Accessories

Item	Part Number
Direct Connect Cables, Small Clip, 1/4" (6.4 mm), Communications version, 10' (3 m) cable length	2892
Direct Connect Cables, Large Clip, 5/8" (15.8 mm), Utility version, 10' (3 m) cable length	2876
Direct Connect Cables, Small Clip, 1/4" (6.4 mm), Communications version, 5' (1.5 m) cable length	9012
Ground Extension Cable	9043
Dyna-Coupler Clamp 3" (75 mm)	3001
Dyna-Coupler Clamp 4.5" (114 mm)	4001
Dyna-Coupler Clamp 6" (150 mm) w/ pouch	1196
Locator Coupler Accessory Kit, 3" (75 mm) (includes 3" (75 mm) Dyna-Coupler, Coupler Cable and Coupler Pouch)	3019
Locator Coupler Accessory Kit, 4.5" (114 mm) (includes 4.5" (114 mm) Dyna-Coupler, Coupler Cable and Coupler Pouch)	4519
Locator Coupler Accessory Kit, 6" (150 mm) (includes 6" (150 mm) Dyna-Coupler, Coupler Cable and Coupler Pouch)	1196/C
Coupler Cable 12' (3.6 m)	9011
Rechargeable Battery (12-volt DC)	2200RB
Cigarette Lighter Adapter Cable (12-volt DC)	457-594-000
Carrying Bag	2200M
33 kHz Sonde (ADP; Active Duct Probe)	3229
Earth Contact Frame (A-Fame)	3014
Earth Contact Frame (A-Fame) Cable	9026

# 24. Receiver Specifications

Item	Specification
Modes	Directional Peak Directional Null Special Peak Induction Peak
Frequency Response:	
Active	577 Hz 8 kHz 33 kHz 200 kHz
Passive	31.5 kHz (CATV) 9 – 30 kHz (LF)
Power	50 Hz, 5th and 9th harmonic of 50 Hz 60 Hz, 5th and 9th harmonic of 60 Hz (100 / 120 Hz) rectified power
Auxiliary	333 Hz 512 Hz 560 Hz
User Defined Frequencies	Four
Display	LCD
Gain Control	Manual and Automatic
Weight w/batteries	4–5 lbs. (1.8–2.3 kg) (model dependent)
Battery Qty. and size	8 AA (LR6)
Battery Life	30 hours average
Depth Accuracy	±2% ± 2 in. (5 cm) for 0–60 in. (0-1.5 m) ±6% ± 2 in. (5 cm) for 60–120 in. (1.5–3.0 m) ±10% ± 2 in. (5 cm) for 120–180 in. (3.0 m–4.5 m)
Depth Range	0–360 in. (0–914 cm)
Marker depth accuracy	± 15% ± 2 in. (5 cm)
Maximum Program Range	
3M iD Markers	
Near-Surface	6 in (15 cm)
Ball Marker	12 in (30 cm)
Full-Range	24 in (61 cm)

Item	Specification
<b>Read Range 3M iD Markers</b>	
Near-Surface	3 ft (0.9 m)
Ball Marker	5 ft (1.5 m)
Full-Range	8 ft (2.4 m)
<b>Detection Depth 3M Non-iD (Passive) Markers</b>	
Near Surface	2 ft (0.6 m)
Ball Marker	5 ft (1.5 m)
Mid-Range	6 ft (1.8 m)
Full-Range	8 ft (2.4 m)

# 25. Transmitter Specifications

Item	Specification
Trace Mode	577 Hz 8 kHz 33 kHz 200 kHz
Fault Mode (2273M models only)	10/20 Hz - Fault signal 577 Hz / 33 kHz -Trace signal <i>Note: The fault locating limit is 2.0MΩ although the transmitter's ohmmeter mode can display a fault resistance up to 10MΩ.</i>
Tone Mode	577 Hz and 200 kHz pulsing at 8 Hz
Induction Mode	8 kHz (only available on 12 Watt Transmitter) 33 kHz 200 kHz
Output Power (in Direct Connect mode)	3 Watt Transmitter Model Normal setting: 0.5 W High setting: 3 W @ 577 Hz, 8 kHz, 33 kHz; 1 W @ 200 kHz 5 Watt Transmitter Model Normal setting: 0.5 W High setting: 3 W @ 577 Hz, 8 kHz, 33 kHz; 1 W @ 200 kHz Maximum setting: 5 W @ 577 Hz, 8 kHz, 33 kHz; 1 W @ 200 kHz (with external DC power source) 12 Watt Transmitter Model Normal setting: 0.5 W High setting: 3 W @ 577 Hz, 8 kHz, 33 kHz; 1 W @ 200 kHz Maximum setting: 12 W @ 577 Hz, 8 kHz; 10 W @ 33 kHz; 1 W @ 200 kHz (with external DC power source)
Output Voltage (Maximum)	70 Vrms
Output Protection	240 Vrms
Weight w/batteries	w/ alkaline batteries only: 5.2 lbs (2.4 kg) w/ rechargeable battery (2200RB) and alkaline batteries (5W and 12W transmitters only): 9.2 lbs (4.2 kg)
Battery Qty. and size	For Normal and High Output Power: 6 "C" size, Alkaline (LR14) For Maximum Output Power: Rechargeable Battery (2200RB), 12V-6AH, Sealed Maintenance-Free Lead (Pb)-Acid Battery (See safety information below.)
Battery Life	Normal Output Power level: 50 hours typical High Output Power level: 10 hours typical Typical transmitter specified battery life (listed above) is increased by 40% when using the 2200RB Rechargeable Battery (12 volt). Using the 2200RB bypasses the alkaline batteries. Maximum Output Power level: 4 hours typical (Maximum Output Power level achieved using 2200RB Rechargeable Battery.)
External DC Power	9–18 V DC
Rechargeable Battery fuse	5 Amp / 32 Volt Littelfuse MINI® Blade # 0297005
Cigarette Lighter Adapter Cable fuse	4 Amp / Fast Blow 250V

## 26. Environmental and Regulatory Specifications

Item	Specification
Standard	IP54
Regulatory	FCC compliant, FCC Part 15
Operating Temperature	-4°F to 122°F (-20°C to 50°C)
Storage Temperature	-4°F to 158° F (-20°C to 70°C)

## 27. Rechargeable Battery Information

UN2800 classification as “Batteries, wet, Non-Spillable, and electric storage” as a result of passing the Vibration and Pressure Differential Test described in DOT [49 CFR 173.159(d) and IATA/ICAO [Special Provision A67].

### ⚠ CAUTION

#### To reduce the risks associated with environmental contamination and possible injury:

The 12W transmitter utilizes the 2200RB rechargeable battery for the Maximum Output Power level. This is a maintenance-free sealed lead (Pb)-acid battery.

- Replace the battery if the acid solution leaks.
- The batteries are not serviceable.
- Do not disassemble batteries.
- Do not remove vent caps.
- Do not rest tools or cables on batteries.
- Store lead-acid batteries with adequate ventilation.
- Do not heat batteries above 140°F (60°C)
- Never recharge batteries in an unventilated, enclosed space.
- Spent batteries must be treated as hazardous waste. Dispose of batteries and electronic components in accordance with all regulations.
- Do not incinerate batteries.
- Always remove/disconnect batteries when not in use or storing for long periods of time.



Pb.



Pb.

Non-spillable  
BATTERY MUST BE RECYCLED





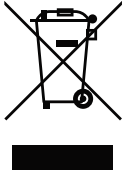

This is the EU symbol for equipment that is covered under the Waste from Electrical and Electronic Equipment (WEEE) directive per CENELEC Specification 5041. It indicates that certain products should not be discarded in the trash, but rather should be recycled. This applies to all electronic pluggable and battery powered products.

3M and Dynatel are trademarks of 3M Company. ArcPad is a trademark of ESRI. MINI is a registered trademark of Littelfuse.

### **Important Notice**

All statements, technical information, and recommendations related to 3M's products are based on information believed to be reliable, but the accuracy or completeness is not guaranteed. Before using this product, you must evaluate it and determine if it is suitable for your intended application. You assume all risks and liability associated with such use. Any statements related to the product which are not contained in 3M's current publications, or any contrary statements contained on your purchase order shall have no force or effect unless expressly agreed upon, in writing, by an authorized officer of 3M.

### **Warranty; Limited Remedy; Limited Liability.**

This product will be free from defects in material and manufacture for a period of one (1) year from the time of purchase. **3M MAKES NO OTHER WARRANTIES INCLUDING, BUT NOT LIMITED TO, ANY IMPLIED WARRANTY OF MERCHANTABILITY OR FITNESS FOR A PARTICULAR PURPOSE.** If this product is defective within the warranty period stated above, your exclusive remedy shall be, at 3M's option, to replace or repair the 3M product or refund the purchase price of the 3M product. **Except where prohibited by law, 3M will not be liable for any indirect, special, incidental or consequential loss or damage arising from this 3M product, regardless of the legal theory asserted.**

# **3M**

### **Track and Trace Solutions**

6801 River Place Blvd.  
Austin, TX 78726-9000  
1-800-426-8688  
[www.3M.com/dynatel](http://www.3M.com/dynatel)

Please Recycle. Printed in USA.  
© 3M 2010. All Rights Reserved.  
78-8130-6150-0-F