



NSG 5500 AUTOMOTIVE TRANSIENT IMMUNITY GENERATOR

HARDWARE GUIDE

NSG 5500 AUTOMOTIVE TRANS- SIENT IMMUNITY GENERATOR

HARDWARE GUIDE

CONTENTS

1	Safety instructions	5
1.1	Classification of dangers	6
1.2	Warning symbols on the test system	6
1.3	Excess voltage category	7
1.4	Range of validity	7
1.5	SYSTEM STOP button	7
1.6	Safety of operation	8
1.7	Personnel	8
1.8	Responsibility for safety precaution	8
1.9	Safety regulations	8
1.10	Reduction of operational safety	9
1.11	As agreed use	9
1.12	General instructions	9
1.13	Installation	10
1.14	Test execution	11
1.15	Dangers concerning the generator	11
1.16	Dangers concerning the DUT	12
2	Installation	13
2.1	Checking the shipment	13
2.2	Delivery contents	13
2.3	Operating position	13
2.4	Line voltage connection and grounding	13
2.4.1	Mains voltage selector	14
2.5	Installation / set-up NSG 5500	17
2.6	Installation / set-up FT 5531	18
2.6.1	Test set-up	18
2.6.2	Parameter references	19
2.7	Installation / set-up LD 5505 and LD 5550	20
2.7.1	Test set-up	20
2.7.2	Parameter references	21
2.8	Installation / set-up MT 5511	22
2.8.1	Test set-up	22
2.8.2	Parameter references	23
2.9	Installation / set-up control unit (CTR)	24
2.9.1	Setting the IEEE address	24
2.9.1.1	IEEE address setting CTR 5500	24
2.9.1.2	IEEE address setting CTR 5501	25
2.9.2	Updating NSG 5500 firmware	25
2.9.2.1	Updating the firmware CTR 5500	26
2.9.2.2	Updating the firmware CTR 5501	26
2.9.3	Installing the USB driver for the NSG 5500 (CTR 5501 only)	28
3	Operation	32
3.1	General system overview	32
3.2	NSG 5500 Operation	33
3.2.1	Introduction	33
3.2.2	Powering up the system	34

3.2.3	NSG 5500 System overview	35
3.2.3.1	CDN 5500 - Power entry and battery switch	36
3.2.3.2	Control unit	39
3.2.3.3	HV-supply	40
3.2.3.4	System block diagram	41
3.2.3.5	External connection of pulse 4 amplifiers	42
3.2.4	Remote programming	43
3.2.5	External trigger and control signals	43
3.2.5.1	Start/stop signal	44
3.2.5.2	DUT FAIL signal	45
3.2.5.3	CRO trigger	45
3.2.5.4	Test end	46
3.2.6	RS 232 wiring diagram	46
3.2.6.1	Optical interface	46
3.3	FT 5531 Operation	47
3.3.1	Introduction	47
3.3.2	Block diagram	48
3.3.3	Tests with a coupling clamp	49
3.4	LD 5505 and LD 5550 Operation	51
3.4.1	Introduction	51
3.4.2	Block diagram	52
3.4.3	External output resistance (LD 5505 only)	52
3.5	MT 5511 Operation	53
3.5.1	Introduction	53
3.5.2	Block diagram	55
3.5.3	Transient diagram	55
4	Maintenance	56
4.1	Cleaning the equipment	56
4.2	Moving and storing the device	56
4.3	Protection	57
4.3.1	Magnetic circuit breaker	57
4.3.2	Fuses	58
4.4	Declaration of conformity CE	61
5	Technical Data	62
5.1	Technical specifications	62
5.1.1	NSG 5500	62
5.1.2	MT 5510	62
5.1.3	LD 5505	63
5.1.4	LD 5550	63
5.1.5	FT 5530	63
5.1.6	FT 5531	63
5.2	Measures and weight	64
5.3	Environmental Conditions	64
6	Addresses	66

1 SAFETY INSTRUCTIONS



DANGER!

It is imperative that you read the following safety instructions and all safety instructions in the manuals of connected peripheral systems before installing and starting this test system for the first time.



DANGER!

The electrical and mechanical safety equipment must not be removed, put out of operation or bypassed. Handle all safety equipment with care. If a safety device should be broken or is not working, the system must be put out of operation until the safety device is repaired or exchanged and fully in working order again.



DANGER!

HAZARDOUS AREA! Connectors on the test equipment must not be touched!



Only connect and disconnect the DUT and/or fixture when the "SYSTEM STOP" button is pressed.

The equipment may only be operated within an area that is explicitly declared a «Test Floor» (with appropriate signs) and protected against improper access.

These operating instructions form an integral part of the equipment and must be available to the operating personnel at all times. All the safety instructions and advice notes are to be observed.



1.1 Classification of dangers



The safety instructions in this manual are classified in different levels. The table below shows a survey over the relation of symbols (ideograms) and signal words to the specific risk and the (possible) consequences.

Warning symbol	Signal word	Definition
	DANGER!	Possibly dangerous situation, that may cause damage to persons or heavy damage to the tester and/or the equipment.
	CAUTION!	Situation, that may cause damage to the tester and/or the equipment
	NOTE!	User tips and other important or useful information and comments

1.2 Warning symbols on the test system

Different warning symbols are placed on the test system. The following table shows the assignment of symbols and signal words to the specific risk.

Warning symbol	Signal word	Definition
	DANGER!	Warning of voltages that might involve the risk of electric shock
	CAUTION!	Warning of a danger spot (refer to the documentation)

Caution symbol	Definition
	Warning of voltages that might involve the risk of electric shock
	Warning of a danger spot (refer to the documentation)

1.3 Excess voltage category

The test system NSG 5500, as described in this manual, is related to the excess voltage category II according IEC 60664.

1.4 Range of validity

These instructions are valid for the complete installation. Further safety regulations for components installed in this test system or additional installed devices are not suspended by these instructions.

1.5 SYSTEM STOP button

Pressing the "SYSTEM STOP" button (on the front panel of the FT 5531) or opening another safety circuit cuts the voltages that may involve electrical shock by touch.



DANGER!

The "SYSTEM STOP" button does not disconnect the test system from the line voltage!

If a danger for life, machine or the product occurs, the "SYSTEM STOP" button must be pressed! Thereby the test voltage in the DUT is disconnected.



NOTE!

After resetting the "SYSTEM STOP" button, the test system must be restarted before continuing operation is possible.

1.6 Safety of operation

Reliable function and safe operation of the test equipment are ensured only if the relevant general precautions as well as all safety instructions given in this manual are observed.

In particular, observe the following:

- Connect the generator only to line voltage that confirms to the power specification given on the type label (on the back of the test system).
- Do not touch any conductive parts at the test point connectors, the fixture and the test object during a test run.
- Never apply external voltage to the system's output connectors.
- Disconnect the generator from the mains before opening the casing for maintenance or repair.
- During operating the generator always observe the relevant rules of ESD (Electro Static Discharge) protection.
- To guarantee the EMC features of the NSG 5500, the control computer must meet the requirements of the EN 50082, 55011, 61000 standard.
- The operation of radio equipment or other high frequency emitting devices near the DUT or adaptation cables, may possibly lead to wrong test results (while HF energy is emitted).
- Observe the environmental conditions as described in chapter 5.3 Environmental conditions.

1.7 Personnel

The generator may be operated by qualified personnel only. It may be opened for adjustment, maintenance or repair by authorized staff only. Teseq or its representative may not be held responsible for service not performed by Teseq personnel.

1.8 Responsibility for safety precaution

The owner, operation supervisor and/or operator of the equipment are responsible for safety. The owner, operation supervisor and/or operator are in charge of any safety measures that do not directly concern the generator itself. For details, see the relevant accident prevention regulations. See also the safety instructions in the manufacturer's manual included with any additional instrument or device you intend to use with your Teseq equipment.

Neither Teseq AG nor any of the sales organisations can accept any responsibility for personal, material or consequential injury, loss or damage that results from improper use of the equipment and accessories.

1.9 Safety regulations

According to the EN 50191 standard, this equipment may involve the risk of electric shock. The owner, operation supervisor and/or operator are responsible to build-up and operate the equipment according to the EN 50191 standard. Conductive parts must not be touched, and the test station must have appropriate warning labels and signs. In general, observe the industrial health and safety standards pertaining to electrical test installations in your country.

The construction of the equipment conforms to the safety requirements of IEC 348 and provides all the prerequisites for safe and reliable operation. Development and manufacture is in compliance with ISO 9001.

The equipment conforms to the safety requirements of IEC 1010-1/EN 61010-1 (safety requirements for electrical equipment for measurement, control and laboratory use). The switching power supply conforms to IEC 950.

All mains driven types of generators are equipped for high voltage working safety in accordance with VDE 0104.

The EMC compatibility has been tested with EN 61326 version 03/2002.

1.10 Reduction of operational safety

If you have any reasons to suppose that the test equipment is not completely safe, you must shut it down and put it out of operation. Moreover, you must mark or label the equipment appropriately so it will not inadvertently be put into operation again. You should then call authorized service personnel for assistance.

1.11 As agreed use

The tester may be used exclusively for simulation of automotive EMC events.

1.12 General instructions



CAUTION!

Use of the generator is restricted to authorised and trained specialists.



DANGER!

Output connections must not be handled while pulses are being generated. During pulse generation, high voltages and currents are present at the output terminals. BNC output connectors are accessible and can have hazardous live voltages present while in operation.

The generator is to be used only for the purposes set down by the manufacturer. It is the user's responsibility to ensure that the test set-up does not emit excessive radiation that may effect other equipment. The instrument itself does not produce excessive radiation. However, applying interference pulses to an DUT may cause that DUT and its cables to start radiating EMI. The method recommended by standards bodies to prevent unwanted emission is to operate the test set-up in a Faraday cage.



DANGER!

The construction of the unit renders it unsuitable for use in an explosive atmosphere.



DANGER!

Persons fitted with a heart pacemaker must not operate the instrument nor approach the test rig while it is in operation.

Only approved accessory items, connectors, adapters, etc. are to be used to ensure safe operation.

1.13 Installation

The instrument conforms to protection class 1.

Local installation regulations must be respected to ensure the safe flow of leakage currents.



DANGER!

Persons fitted with a heart pacemaker must not operate the instrument nor approach the test rig while it is in operation.

Two independent protective earth connections are necessary (instrument and DUT supply) connected back to the local permanent installation or to a fixed, permanent protective earth conductor.

Operate the equipment only in dry surroundings. Any condensation that occurs must be allowed to evaporate before putting the equipment into operation. Do not exceed the permissible ambient temperature, humidity or altitude. This equipment must not be used in an enclosed space that would restrict the air flow through the instrument.

Use only legally approved connectors and accessory items. The instrument must be powered from a mains supply that provides a properly earthed mains socket. Before the unit is powered up, check that the voltage selector on the instrument is set to the correct position.

Ensure that a reliable return path for the interference current is provided between the DUT and the generator. The reference ground plane and the earth connections to the instruments as described in the relevant test standard serve this purpose well.

The instruments must not in principle be opened. This may only be undertaken by a qualified specialist if specifically instructed to do so in the operating manual. Since the equipment generally works with two independent power supplies for the generator and the DUT, the instrument must first be disconnected from both sources before any changes are made. Besides the mains supply itself, certain instruments also operate at high voltages which are not provided with any internal form of extra protection against being touched.

Ensure that all unused slots are blanked off before powering up.

1.14 Test execution

The test area must be so organised that no unauthorised persons have access during execution of a test. DUTs, together with their accessories and cables, are to be considered as being live during a test. The test generator must be stopped and the DUT supply interrupted before any work is carried out on the DUT. This can be implemented by pressing the "SYSTEM STOP" button.



DANGER!

The DUT is to be tested only in a protective cage or under a hood which provides protection against electric shock and all manner of other dangers pertaining to the particular DUT (see Dangers concerning the DUT).



CAUTION!

The safety instructions concerning all the instruments and associated equipment involved in the test rig are to be observed.



CAUTION!

The configuration of the test rig is to be strictly in compliance with the methods described in the relevant standard to ensure that the test is executed in a standard conforming manner.

1.15 Dangers concerning the generator



DANGER!

Dangers from a disrupted DUT.



DANGER!

Local burning, arcing, ignition of explosive gases.



DANGER!

Danger from the resultant DUT supply current caused by a flashover or breakdown resulting from the superimposed high voltage effects.



DANGER!

Disturbance of unrelated electronics, telecommunications, navigational systems and heart pacemakers through unnoticed radiation of high frequency energy.

In most test rigs the interference voltage is superimposed on the protective earth conductor of the DUT in accordance with the requirements of the test standard. Earth contacts or pins (e.g. in German and French connectors) as well as the DUT earth can hence be at a dangerous to touch voltage. The screws, too, in certain connectors are also linked to the protective earth conductor.

1.16 Dangers concerning the DUT

DUTs are often simply functional samples that have not previously been subjected to any safety tests. It can therefore happen that in some cases that the DUT is quickly damaged by internal overloads caused by the control electronics being disrupted or it may even start to burn.

**CAUTION!**

As soon as the DUT shows signs of being disrupted the test must be stopped and the power to the DUT switched off.

**DANGER!**

Internal disruption of the electronics can result in the interference voltage or the DUT supply voltage being present on the DUT's housing.

**CAUTION!**

Electrical breakdown or arcing from and in plugged connections that are overstressed voltage-wise during the test.

**DANGER!**

Explosion of electronic components with fire or fragmentation as a result of the energy dissipated, e.g. from the resultant supply current or ignition of vaporised plastics materials.

**CAUTION!**

Faulty behaviour by the DUT, e.g. robot device strikes out, temperature controller fails, etc.

2 INSTALLATION



2.1 Checking the shipment

Upon receiving the shipment, first check the packaging and outer equipment cover for visible damage. Also, check packaging and casings of peripherals (if you ordered any). Record in writing any defects which were possibly caused in transit. If the shipment shows damage or is not complete, immediately advise the shipping agency and/or your dealer.

2.2 Delivery contents

The standard delivery contains the NSG 5500 with connection cables and the instruction manual. Optional modules are installed in the NSG 5500 if ordered. Possibly, there is also optional equipment, e.g. computer or printer.

2.3 Operating position

The NSG 5500 must be placed in upright position firmly and securely during operation.

2.4 Line voltage connection and grounding



DANGER!

Connect the NSG 5500 only to line voltage conforming to the power specification given on the type label.

If the grounding is interrupted inside or outside of the equipment, the NSG 5500 will become a source of danger. Additionally, the output of the device may not conform with the relevant test standards when the grounding of the power plug is interrupted. Carefully observe grounding precautions. The plug on the power cord may be replaced by qualified personnel only.

The power input of the tester is located on the rear side of the NSG 5500 (see picture 3-4). The power input is secured by two 3.15 A time-lag fuses (220–240 V range) or two 6.3 A time-lag fuses (110–120 V range). For details, refer to chapter 4.3 Protection.

The power plug and outlet must have grounding contacts. When the NSG 5500 is brought from cold to warm environment, the ensuing condensation may bring about dangerous conditions.



DANGER!

The NSG 5500 may only be switched on after all parts have acclimatized.

2.4.1 Mains voltage selector

The mains voltage selector is a small drawer placed in the mains input / main switch module. The user can select the regional input voltage range (110–120 V or 220–240 V) by pulling out the selector (using a small screwdriver) and turning it. The selected voltage range is marked by the small arrow on the module that points to the white mark at the input connector assembly.



- The small bar indicates the voltage range selected (220–240 V selection shown)

Picture 2-1: Mains voltage selector (220–240 V range selected in the picture).

To select the other voltage range, proceed as follows:



DANGER!

The NSG 5500 must be disconnected from the mains before working on the mains voltage selector by disconnecting the power cord!

- Carefully loosen the drawer from the input connector assembly using a screwdriver and turning it slightly in both directions as shown in the picture below.



Picture 2-2: Loosen the drawer using a screwdriver

- Pull out the drawer from the input connector assembly.



Picture 2-3: Pull out the drawer

- Turn the drawer until the text of the desired voltage range and its arrow is on the bottom of the drawer.



Picture 2-4: Turn the drawer

- Push the drawer back in ...



Picture 2-5: Push the drawer back in.

- ... until it is fixed to the input connector assembly again.



Picture 2–6: Fix the drawer to the input connector assembly

- Now reconnect the NSG 5500 to the mains.

2.5 Installation / set-up NSG 5500

This section outlines a brief checklist of items that should be done before the unit is powered up and put into service. The NSG 5500 may be set up by qualified personnel only. It is imperative to observe the safety instructions at the beginning of this manual.

- Check that all items and accessories ordered have been delivered.
- Inspect the equipment for damage during transit. Any damage found should be reported to the carrier immediately.
- Carefully study the documentation and operating instructions supplied.
- The mains voltage selector on the rear of the instrument must agree with the local mains voltage (mains frequency: 47–63 Hz)
- Connect the mains cable to a mains outlet that has a good earth connection.
- Ensure that all modules are inserted correctly and screwed home tightly.
- Observe, and adhere to, the polarity of all input and output connections.
- Power up and operate according to the instructions supplied.



NOTE!

The three modules contained herein are simply the most commonly required transient generators. Additional generators are available for use in the NSG 5500. These additional generators will be supplied with their own user's guide.

2.6 Installation / set-up FT 5531

Check the instrument for any mechanical damage. Report any damage found to the carrier immediately.



NOTE!

The FT 5530 and FT 5531 are functionally identical and may be used interchangeably in this guide. Differences are noted where necessary

Ensure that the power is turned off on the NSG 5500 mainframe and that the battery input is disconnected. Insert the cassette in the second slot from left and push in fully. Screw in the four retaining screws fully.

Turn on the mains input power on the NSG 5500 mainframe. After approximately a two second delay the power LED (red) on the FT 5531 generator should light.

Now the scope calibration setup shown in picture 2-7 should be connected and the output pulses should be quickly checked to ensure that they are of the correct form and shape. When pulses are generated the green LED (3a or 3b, whichever is selected) flashes as pulses are output.

2.6.1 Test set-up

The following set-up can be used to check the integrity of the output pulses. Due to the high frequency nature of the 3a and 3b pulses it is critically important that cable lengths are kept to a minimum and that the test set-up is rigorously adhered to.

The attenuator used in this test set-up is a series combination of two attenuators. The oscilloscope used needs to have a high sampling rate and bandwidth. Refer to ISO 7637-2 for details.

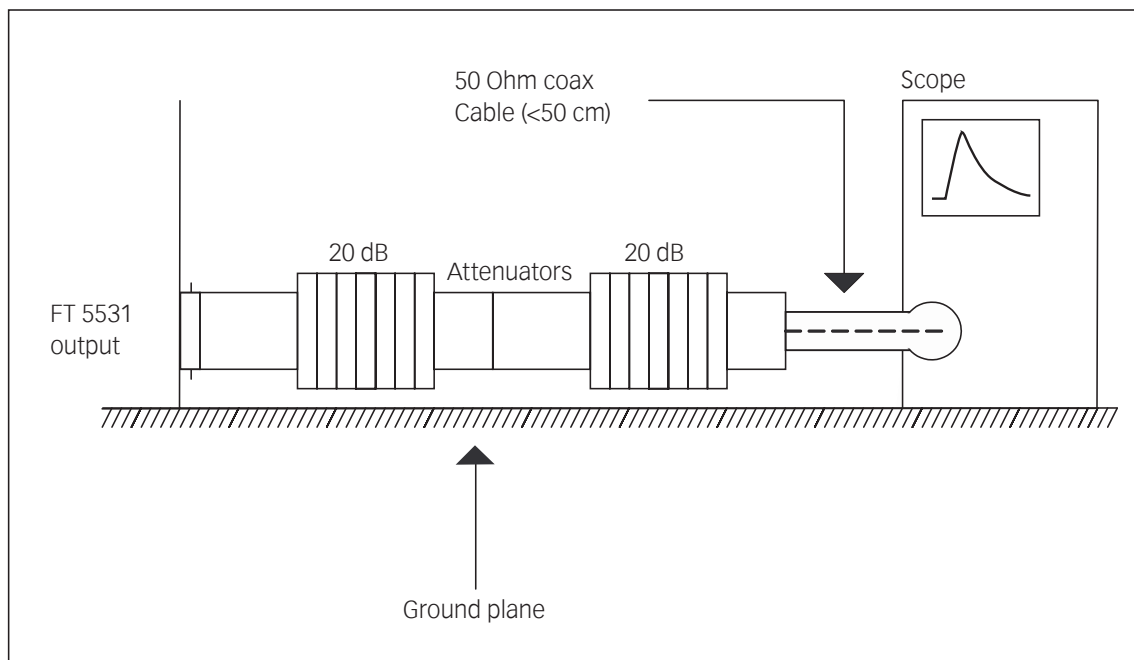

Picture 2-7: Test set-up with the FT 5531 and scope.

2.6.2 Parameter references

The following diagram shows the reference points used for parameter specifications on the FT 5531.

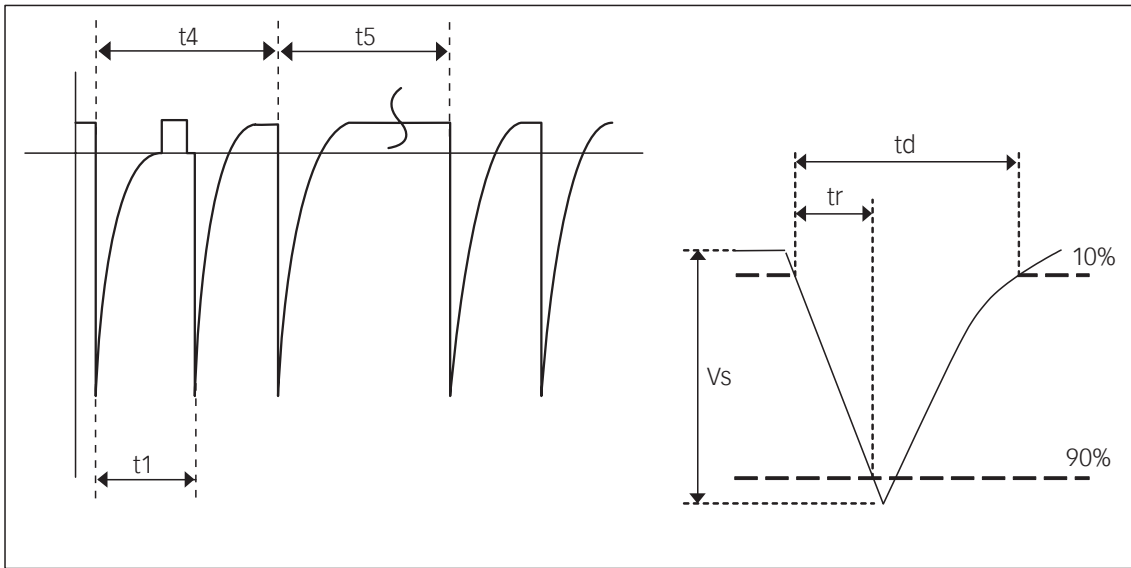

Picture 2–8: Reference points of the FT 5531

2.7 Installation / set-up LD 5505 and LD 5550

Check the instrument for any mechanical damage. Report any damage found to the carrier immediately.

Both LD 5550 and LD 5505 modules are in usage. The term “LD Module” is used to refer to either of these modules. All of this information applies to both modules unless specifically referenced by module name.

Ensure that the power is turned off on the NSG 5500 mainframe and that the battery input is disconnected. Insert the cassette in the right most slot and push in fully. Screw in the four retaining screws fully.

If using the battery switch, ensure this module is present and inserted fully in the rear of the NSG 5500 mainframe.

It is vitally important that the unit is connected to a good, protective earth.

Turn on the mains input power on the NSG 5500 mainframe. After approximately a two second delay the power LED (red) on the LD module should light. After a further two seconds of initialisation, the unit is ready for operation. The software communications will not start correctly until this initialization time is complete.

Now the scope test setup shown in picture 2-9 below 26 should be connected and the output pulses should be quickly checked to ensure that they are of the correct form and shape. When pulses are being generated the relevant green LED (5 or 7, whichever is selected) should flash as pulses are output.

When correct operation has been verified, the DUT can be connected to the “OUTPUT” terminals at the front of the unit, and the required tests can be carried out.

2.7.1 Test set-up

The following set-up can be used to check the integrity of the output pulses. The scope probe should be in conformance with the specifications outlined in ISO 7637-2.

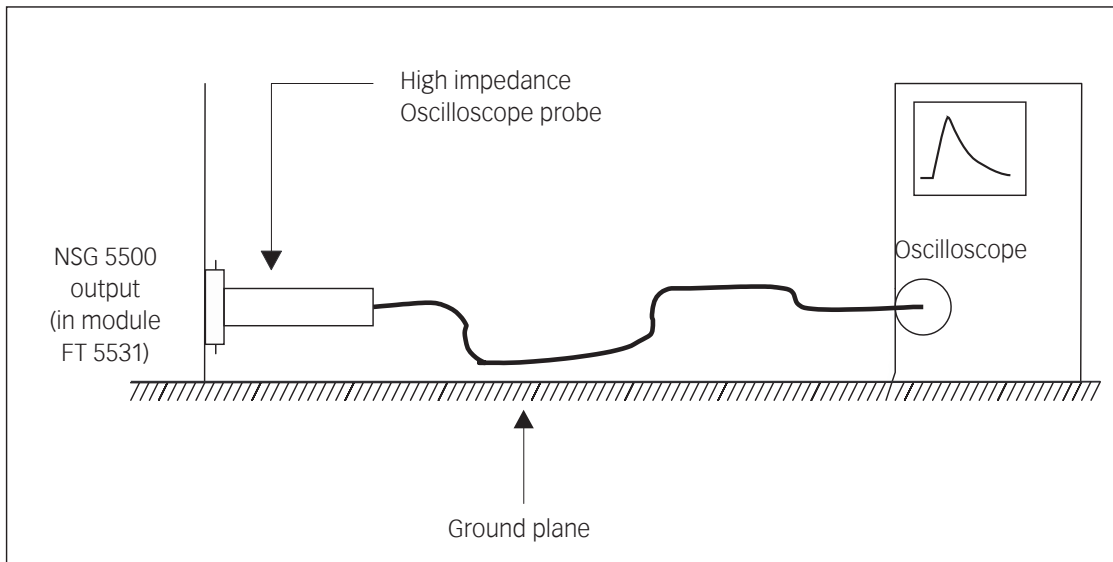

Picture 2–9: Test set-up with the LD 5505 or LD 5550 and scope.

2.7.2 Parameter references

The following diagrams show the reference points for parameter specifications on the module.

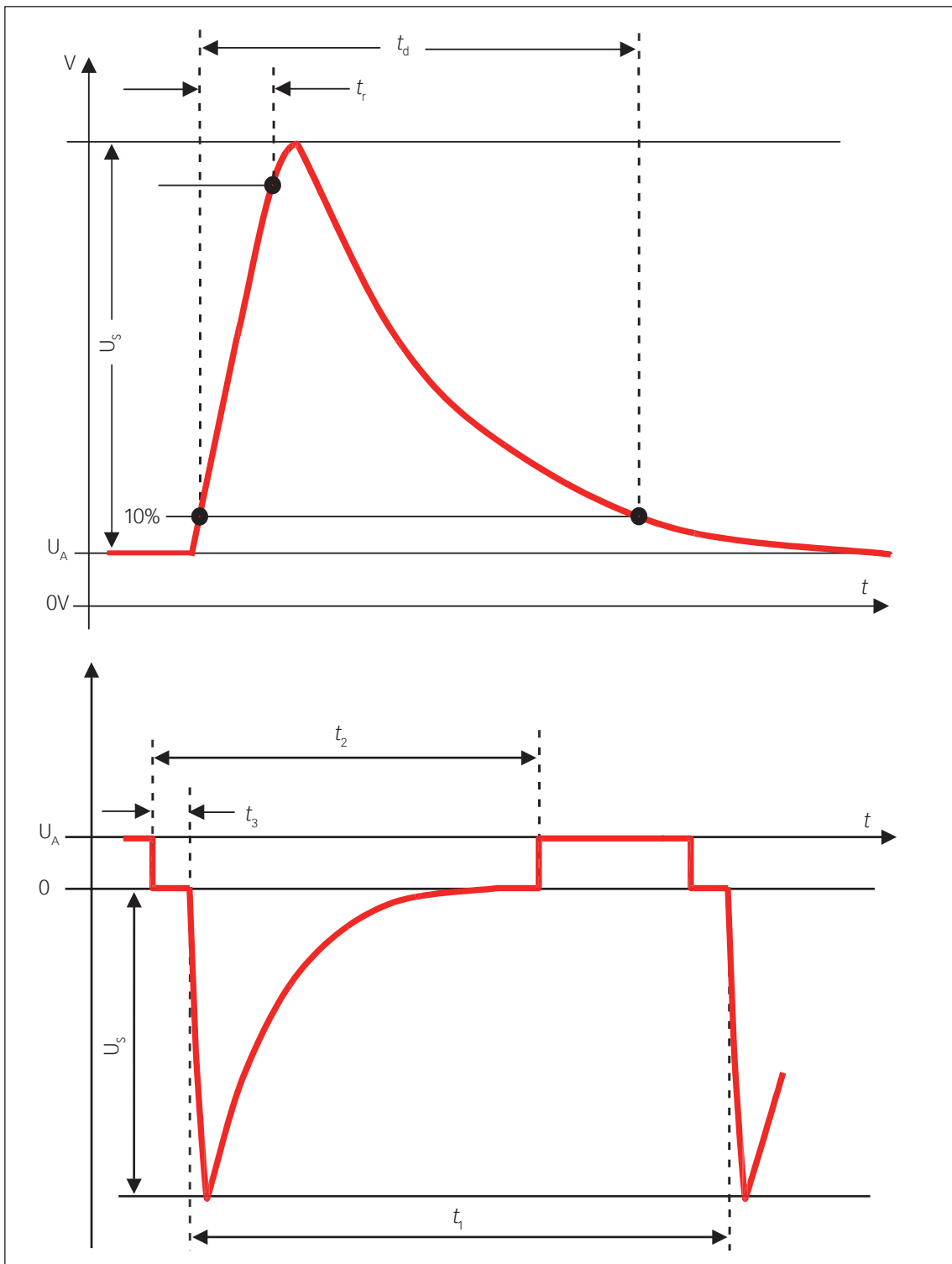

Picture 2-10: Reference points for pulse 5 (upper diagram) and pulse 7 (lower diagram).

2.8 Installation / set-up MT 5511

Check the instrument for any mechanical damage. Report any damage found to the carrier immediately.

Ensure that the power is turned off on the NSG 5500 mainframe and that the battery input is disconnected. Insert the cassette in the most left slot and push in fully. Screw in the four retaining screws fully. The battery switch is required, ensure that this module is present and inserted fully in the rear of the NSG 5500 mainframe.

It is vitally important that the unit mains power is connected to protective earth. Turn on the mains input power on the NSG 5500 mainframe. After approximately a two second delay the power LED (red) on the MT 5511 generator should light. After a further two-second initialisation period, the unit is ready for operation. The software communications will not start until this initialization time is complete.

The scope test set-up shown in picture 2-11 should be connected and the output pulses should be quickly checked to ensure that they are of the correct form and shape. As pulses are generated the "Fire" LED should light briefly.

The MT 5511 should be then verified in accordance with appendix D of ISO/DIS 7637-2:2004 or similar section of the applicable standard.

When correct operation has been verified, the DUT can be connected to the "OUTPUT" terminals at the front of the unit, and the required tests can be carried out.

2.8.1 Test set-up

The following set-up may be used to check the integrity of the output pulses. The scope probe should be in conformance with the specifications outlined in ISO 7637-2.

CAUTION!
it is critical to compensate the probe in advance. Because of the exponential shape of the transients, an uncompensated probe will cause errors on rise time and voltage measurement, and an incorrect pulse shape.

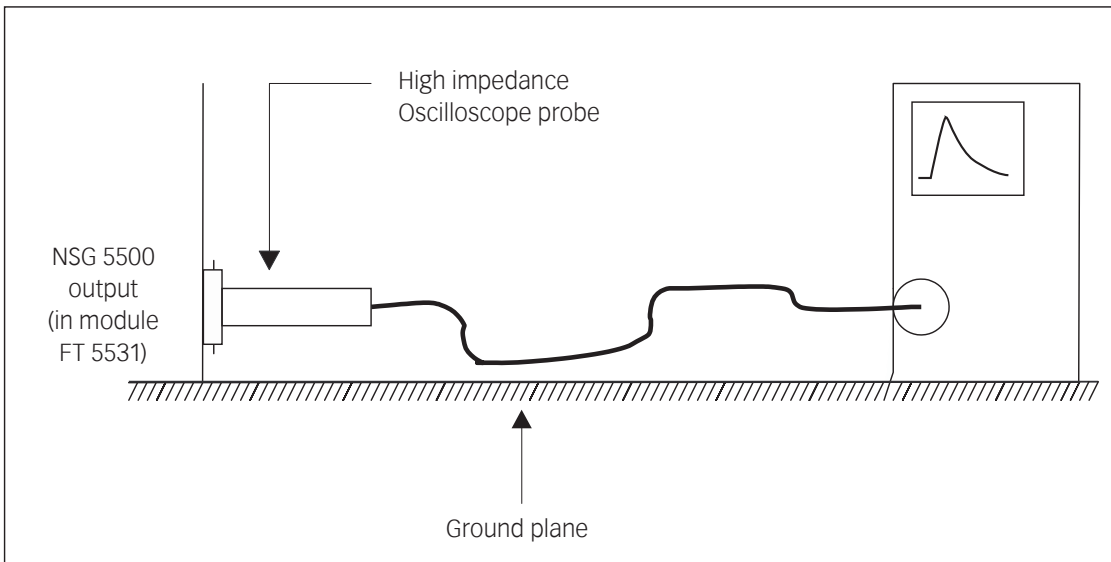

Picture 2-11: Test set-up with the MT 5510 and scope.

2.8.2 Parameter references

The following diagrams show the reference points that are used for parameter specifications on the MT 5511.

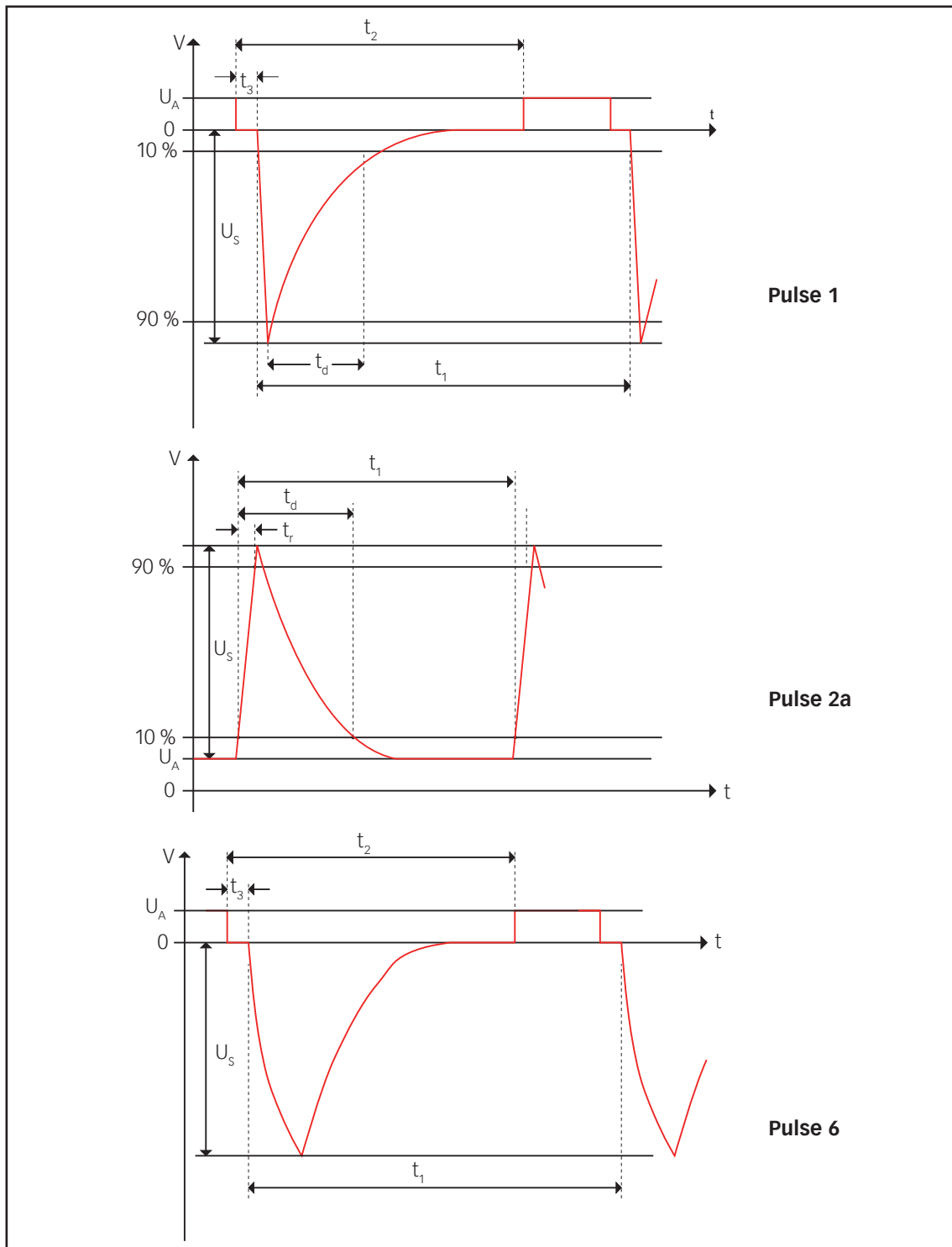

Picture 2-12: Reference points for pulses 1, 2 and 6.

2.9 Installation / set-up control unit (CTR)

There are two controllers in circulation: The CTR 5500 and CTR 5501. The CTR 5501 has some small changes: it supports a new USB connection and has a new method of updating the firmware.



CAUTION!

The IEEE Bus has proven to be a very reliable control method in industrial environments. However, the CTR 5501 supports also USB control. Please note that USB can be affected by disturbances in typical EMC laboratories. For this reason, please use only the supplied USB cable.

Only cables confirming to the USB 2.0 standard and above are supported. Even so, in very noisy environments, the IEEE 488.2 connection is recommended.

2.9.1 Setting the IEEE address

2.9.1.1 IEEE address setting CTR 5500

When communicating with the NSG 5500 via the IEEE 488 Interface it is necessary that the address set in the AutoStar comm setup screen corresponds with the IEEE 488 address set on the control unit.

A DIP switch array on the front panel of the control unit is used to set the NSG 5500 IEEE address. There may be five or six switches on this DIP switch, depending on the hardware version. Only the first five switches are used.

These first five switches correspond to the binary weighted address values 1, 2, 4, 8, and 16. The total sum of the values corresponding to the switches in the "ON" position is the IEEE address. For example, in the illustration below, the address set is $1 + 2 + 8 = 11$.

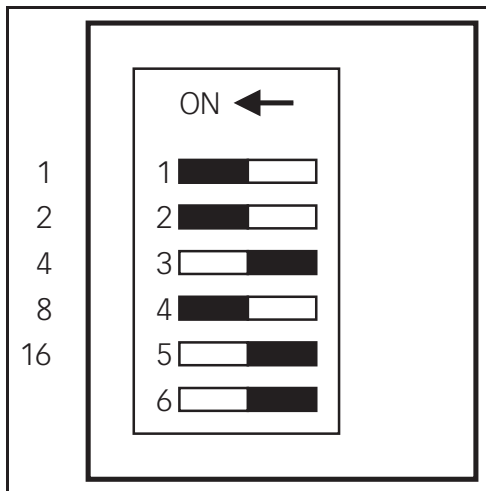

Picture 2–13: DIP switch array to set the NSG 5500 IEEE address.



NOTE!

The address is read only at power on. Therefore, after changing the address setting, the NSG 5500 must be powered off and then on to accept the new setting. The hardware is set at the factory to address 1. This is also reflected in the AutoStar setup.

2.9.1.2 IEEE address setting CTR 5501

The CTR 5501 address can only be set with the tool supplied on the AutoStar CD using a USB 2.0 cable.

To set the GPIB address, it is first necessary to establish a connection using USB. Please see the section on installing the driver.

To choose the GPIB address of the CTR 5501, use the controller update tool "cut.exe" found on the installation CD.

First, scan for instruments and then select the controller that you would like update.

On the "Controller (NSI)" tab, you can simple select the GPIB address and press "Set GPIB address".

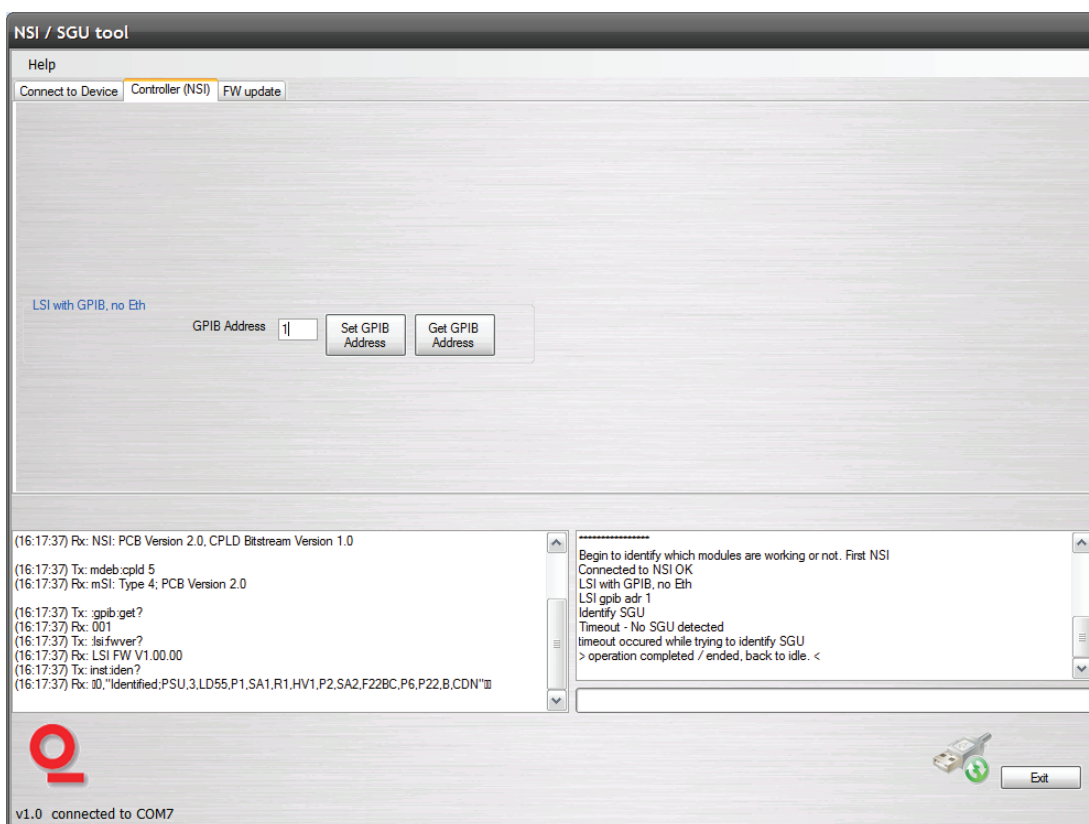

Picture 2–14: Setting the GPIB address

2.9.2 Updating NSG 5500 firmware



CAUTION!

Updating the firmware should only be done with direct assistance of your local support organization.

Incorrectly performed firmware downloads will result in an NSG 5500 that no longer boots and must be sent back for service!

2.9.2.1 Updating the firmware CTR 5500

The firmware of the CTR 5500 can be updated from within AutoStar. To update the CTR 5500, please see the applicable sections.

2.9.2.2 Updating the firmware CTR 5501

The firmware of the CTR 5501 cannot be updated with AutoStar. To update the CTR 5501 firmware, please use the controller update tool found on the AutoStar CD.

Using the controller update tool (cut.exe) found on the installation CD, you can update the firmware. The firmware is located in the same directory as the controller update tool.

You may also choose the version to update if instructed to do so by service personnel.



CAUTION!

You should only perform this step with the assistance of one of our worldwide service representatives.

Incorrectly performed firmware downloads will result in an NSG 5500 that no longer boots and must be sent back for service!

First, scan for instruments and then select the controller that you would like update.

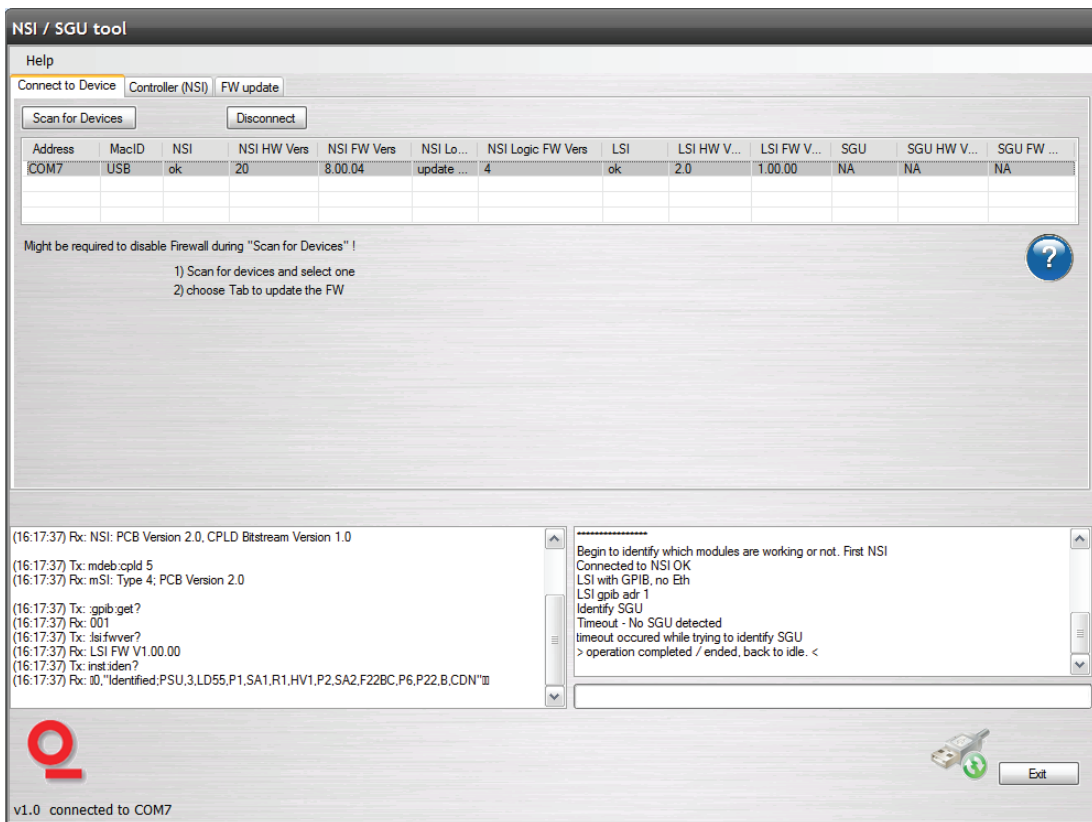

Picture 2–15: Scanning for hardware

NSG 5500 Automotive transient immunity generator

Next, select the "FW update" tab and select "Update CTR FW" to update the firmware. You may also update the hardware logic if instructed to do so by service personnel.

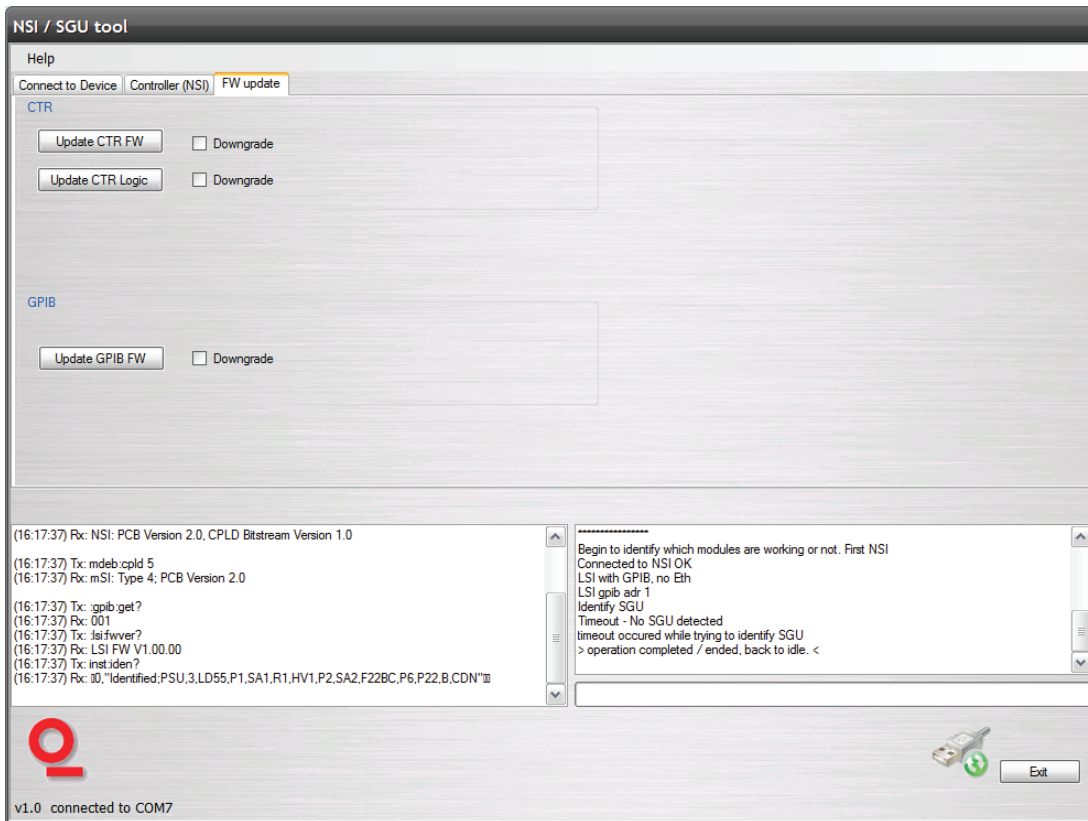

Picture 2-16: Updating the firmware

After completion of the firmware update, restart the hardware then confirm the dialog.

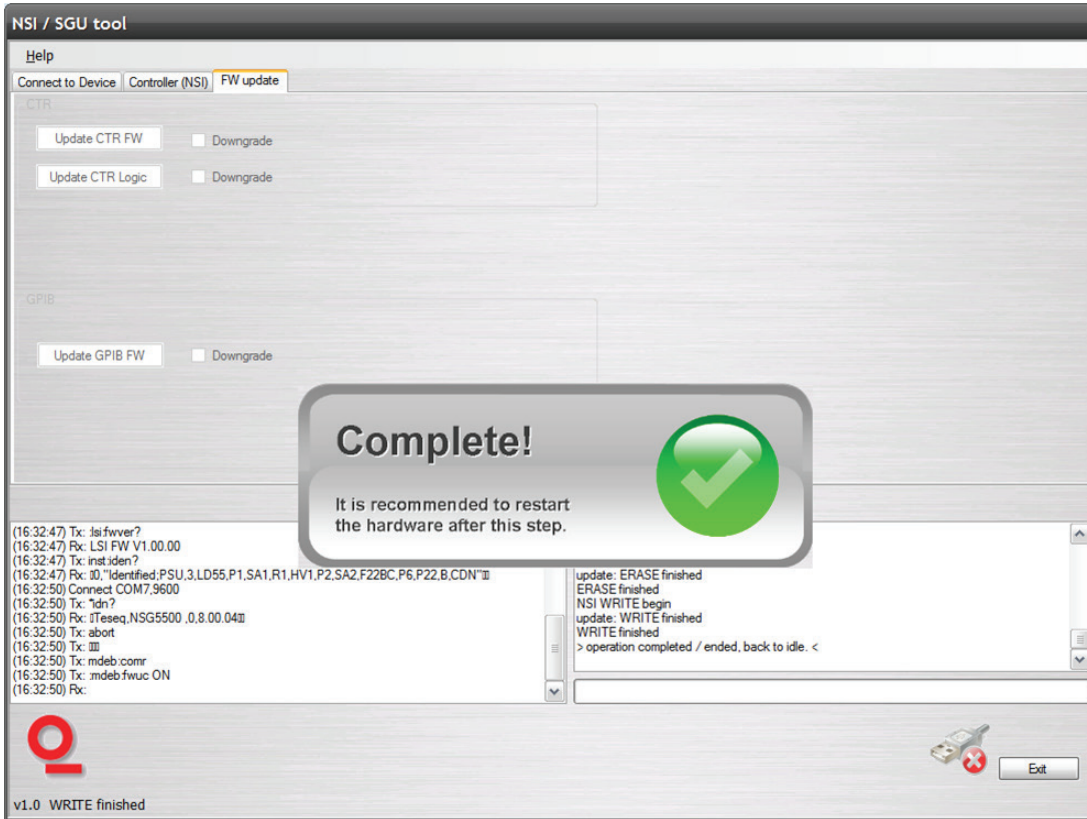

Picture 2–17: Finished - restart hardware now

2.9.3 Installing the USB driver for the NSG 5500 (CTR 5501 only)

On connecting the NSG 5500 to the USB port on your computer, you will get the standard Windows “New Hardware Found” message.

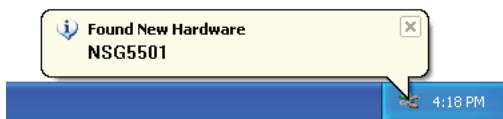

Picture 2–18: Hardware found

Afterwards, you will be prompted a few times to install the necessary USB driver for the instrument.



Picture 2–19: Install the driver

You will need to direct Windows to find the latest driver on the installation CD under \Driver and confirm the WHQL message.

AutoStar will communicate with this device as if it were a serial port. To inform AutoStar which port it should communicate with, it will be necessary to inspect the port in the windows Control Panel Device Manager.

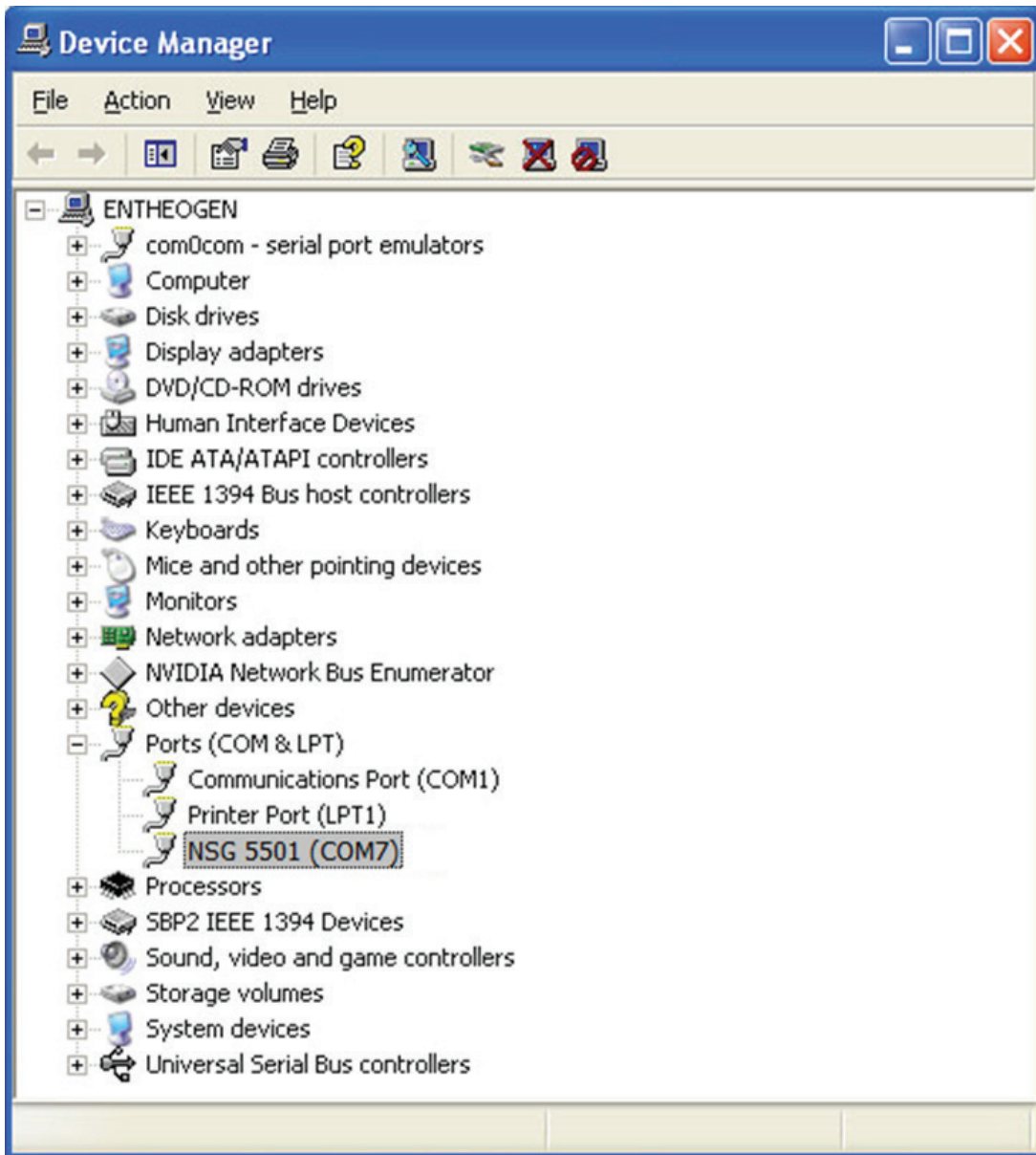

Picture 2-20: Determining the port

As you see in the above example, Windows will assign the port to the generator. Once this is done, you will want to make sure that the same port is selected inside AutoStar by selecting Configuration -> System Configuration.

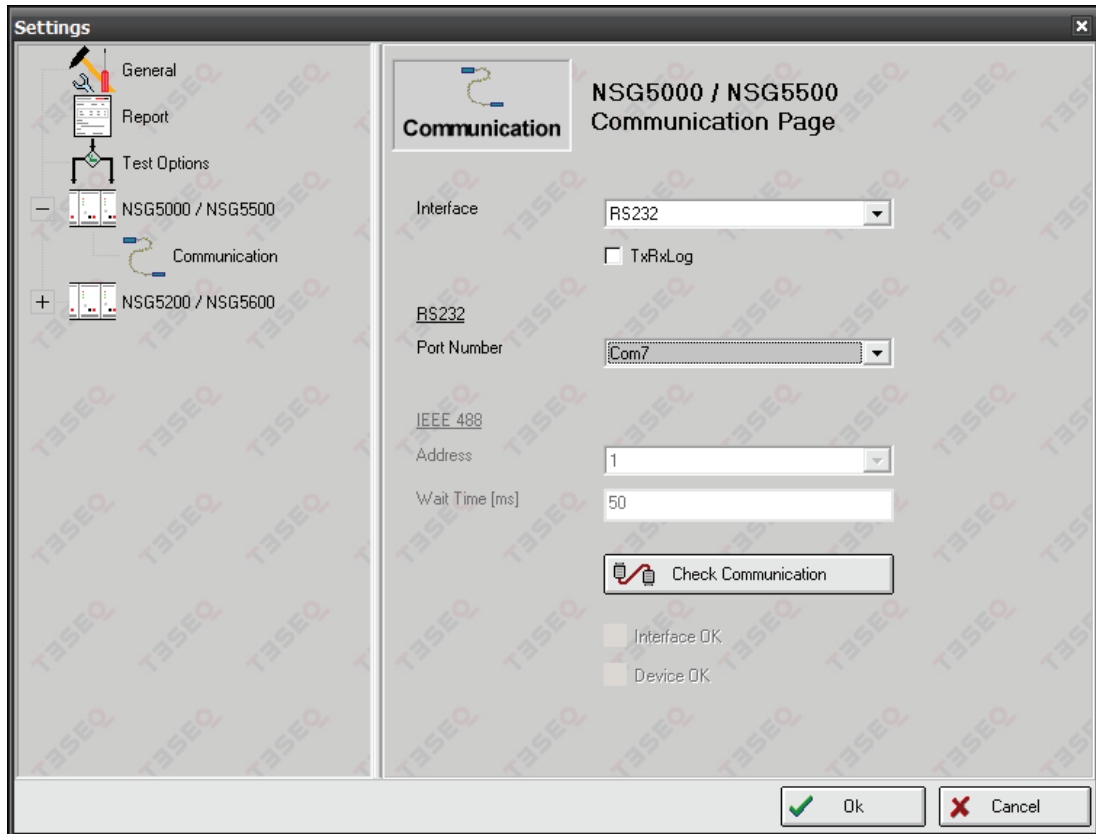

Picture 2-21: Setting the same port in AutoStar

Once you have completed these steps, AutoStar can connect to the NSG 5500 and continue as normal.

3 OPERATION



3.1 General system overview

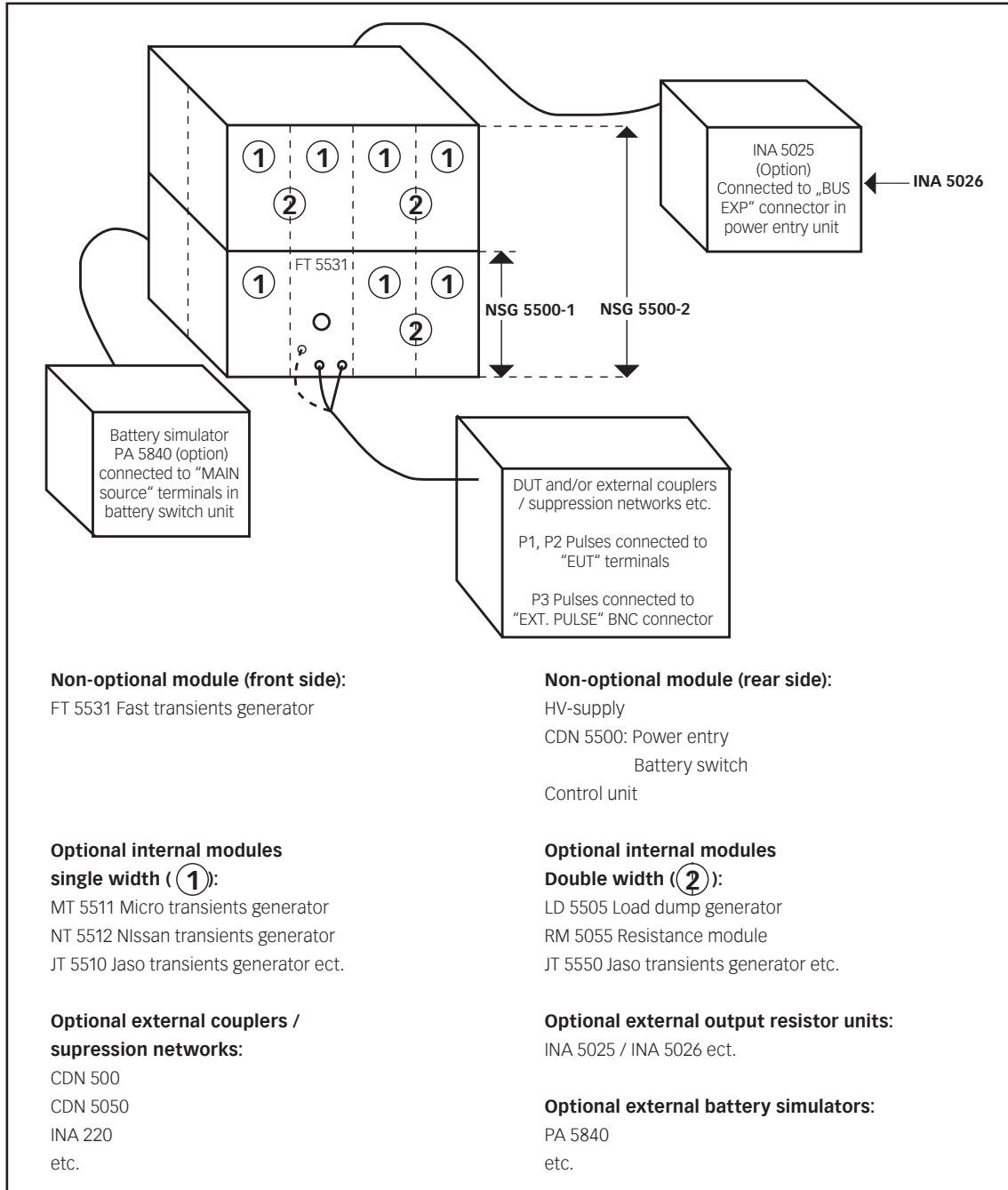

Picture 3–1: System interconnection diagram with optional modules and units.

3.2 NSG 5500 Operation

3.2.1 Introduction

The NSG 5500 EMC test system is designed for testing automotive electronic components and parts. Automotive EMC test requirements are covered primarily in ISO 7637-2. This standard outlines five basic pulse types that are used for automotive EMC testing. The NSG 5500 system is a modular instrument that can generate all of the pulses described in the ISO standard and in many cases to a higher specification than that specified in the standard.

The NSG 5500 is a modular instrument where the pulse generators are designed as plug-in modules that fit into the NSG 5500 mainframe.

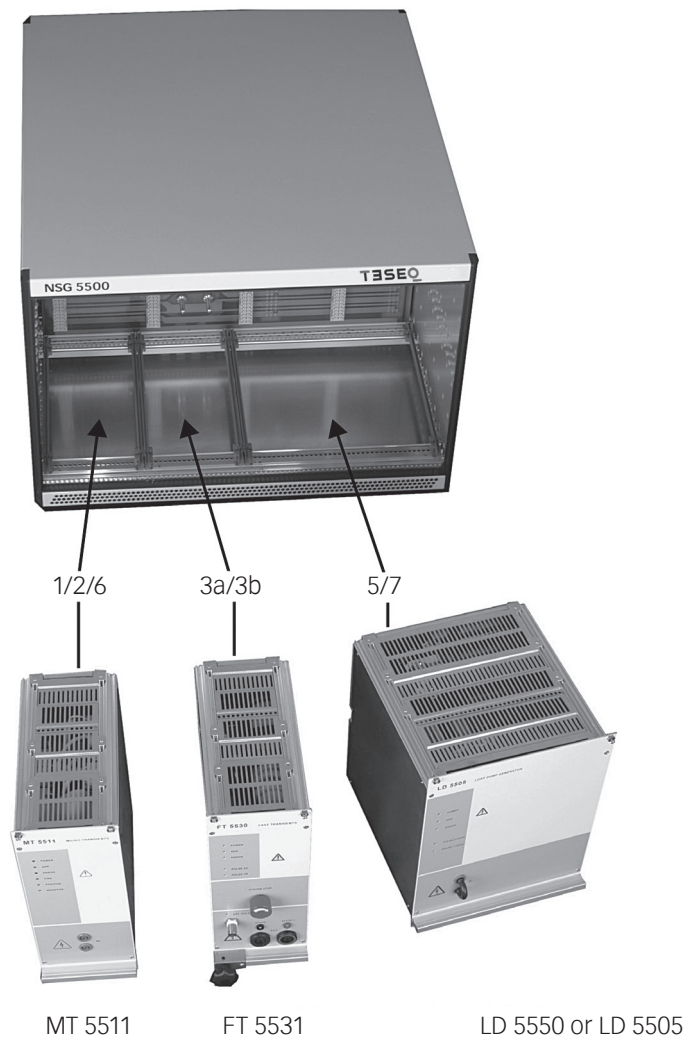

Picture 3-2: NSG 5500 mainframe with module and pulse assignment.

Due to the modular structure of the NSG 5500 you may configure a test system that provides only the pulse requirements that are required for your application by removing and installing additional modules as needed.



NOTE!

Pulses of similar specification and energy requirements are usually housed in the same plug-in unit. For example the ISO pulses 2a and 6 are all supplied within the same plug-in.

The NSG 5500 is fully programmable over USB or RS 232 and IEEE 488 interface bus. A Windows program «AutoStar» is available to provide full remote control via a PC computer. This program allows you to generate pulse sequences, including dynamic ramping, and to generate hardcopy printouts of the test results.

The main features of the NSG 5500 could be summarised as follows:

- Modular construction, pulse modules plug into main chassis
- Exceeds specifications set out in the ISO, DIN and SAE standards
- Remote controllable via USB or RS 232 and IEEE 488
- Internal multiplex bus system (all pulses available from the front of the FT 5531 plug-in)
- Compact construction, 12 inches high (30 cm)
- 19 inch rack mountable
- Windows software program provided
- DUT FAIL, START/STOP, TEST END, AND CRO trig signals available for interfacing with other test equipment

3.2.2 Powering up the system

Switch on the NSG 5500 by switching on the main switch on the rear side in the power entry unit.



CAUTION!

The hardware requires at least 10 seconds to boot. Reliable software communications can not be established until the system is completely booted!



DANGER!

When any Pulse 4 control is used, the power amplifier/battery simulator should always be turned on last to assure safe and reliable control of the power amplifier/battery simulator. Do not, under any circumstances, touch the outputs or connect any DUT to the outputs of the system during booting!

3.2.3 NSG 5500 System overview

The NSG 5500 mainframe is designed to take the pulse plug in units from the front. The system support electronics are plugged in from the rear.

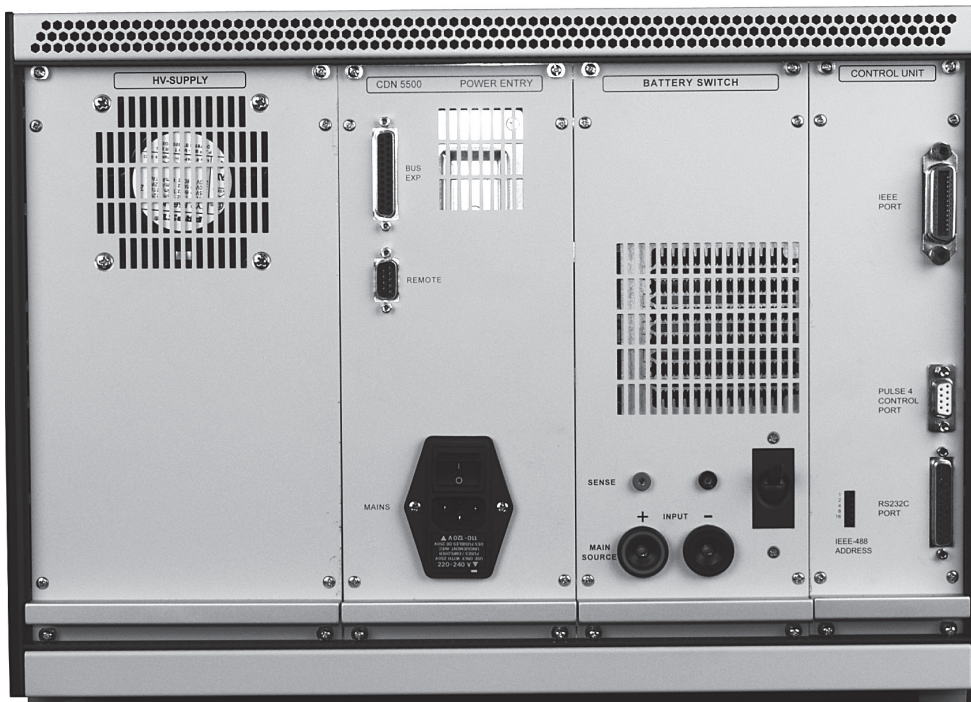

Picture 3-3: NSG 5500 Rear view.

These rear plug in units are not generally removed by the user. These units have a modular construction to facilitate easy maintenance and to allow for future upgrades to the NSG 5500 system. The plug-in units in question are,

- **HV supply:** this is a solid state high voltage programmable power supply that provides the required charging voltage to the pulse generators.
- **Power entry:** this unit facilitates the connection of the mains input to the system and the connection of the battery supply to the power bus. In addition it also provides the input / output connections for the external control signals DUT FAIL, START/STOP, TEST END and CRO.TRIG.
- **Battery switch:** this unit contains a solid state switch and timing electronics which are used for precise timing control of the "ON" and "OFF" periods of the battery power supplied to the device under test (DUT). This is required to meet some of the timing requirements specified in the standards, particularly for negative pulses.



NOTE!

The power entry and battery switch is one functional unit (plugin module).

- **Control unit:** this unit contains the processor board that controls the complete system. The remote control interfaces USB or RS 232 and IEEE 488 are also available via this unit, as well as the optional pulse 4/4c control board.

3.2.3.1 CDN 5500 - Power entry and battery switch

This unit is used to bring mains input into the system and to connect the battery input to the system power bus.

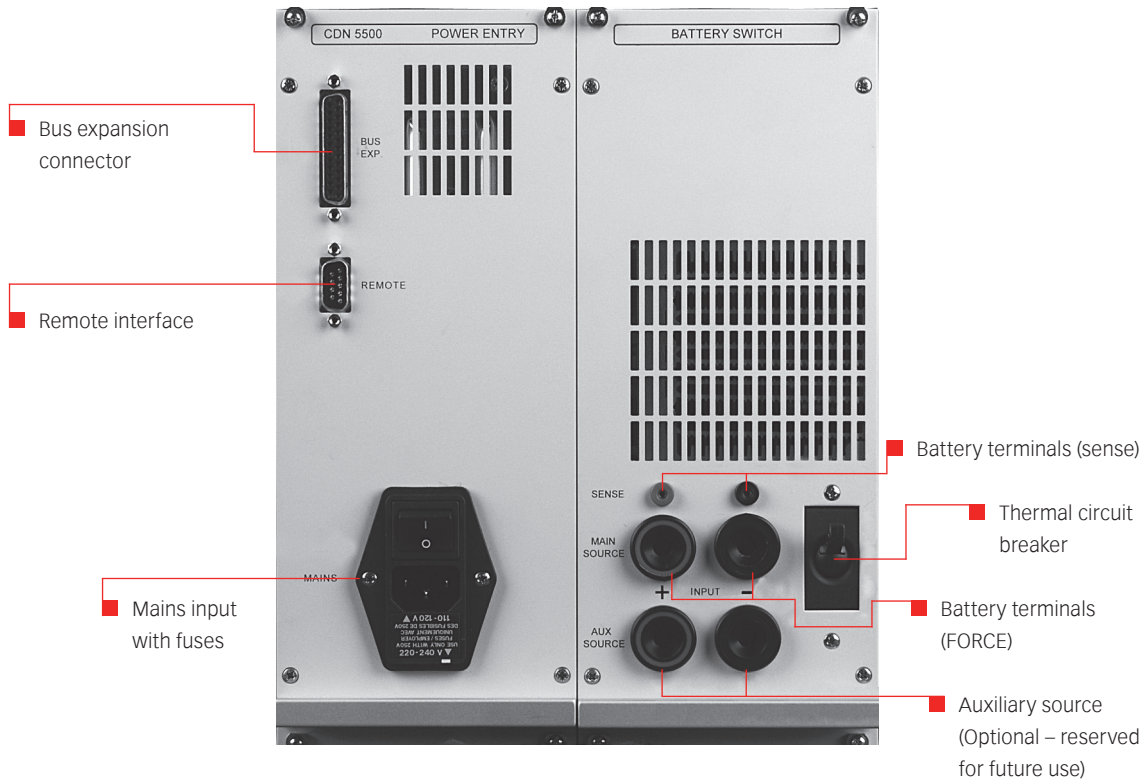

Picture 3-4: CDN 5500

If a DC source with remote sense is being used to simulate the battery input (i.e. supply power to the DUT) then the sense inputs can be used to ensure that the voltage at the main source Input is accurate by compensating for voltage drops in the lines. If a pulse 4/2b amplifier is supplied with the test system then this can also be used as the battery input for all the other pulses. The mains Input unit is fitted with two 3.15 A / 6.3 A time-lag fuses. This is intended to protect the internal power bus in the case of an overload condition.

Mains input power is brought into the system via the power entry module. The power entry module has a mains input power filter socket that allows for adjustment between 110/120 VAC and 220/240 VAC operation. This filter socket contains the two 3.15/6.3 A fuses.

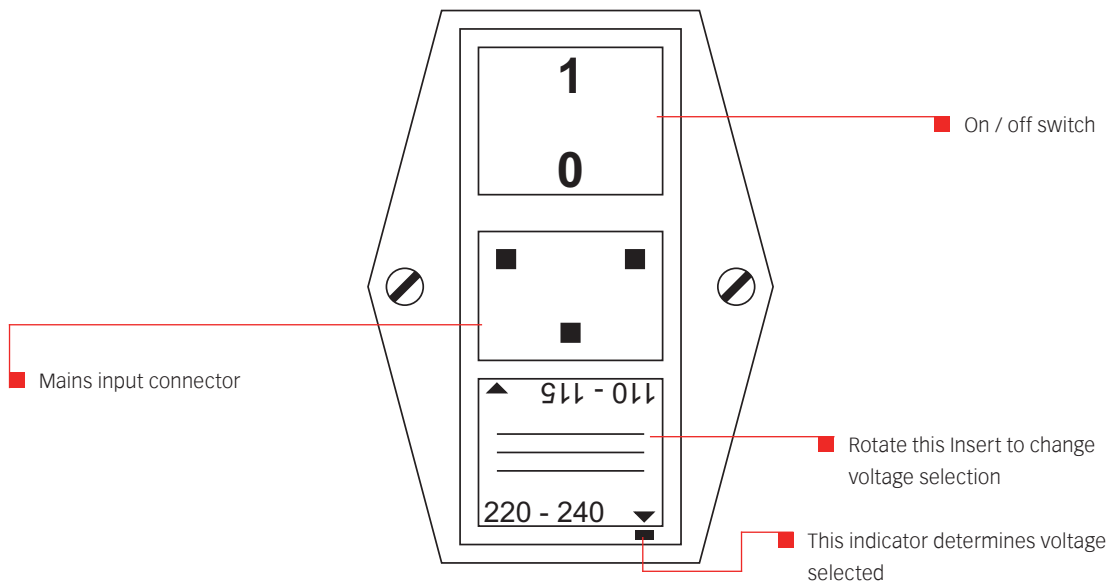

Picture 3-5: Power entry module of the NSG 5500 (located in the CDN 5500).

The battery switch unit is an electronic solid state switch that allows flexible control of the power bus output during the generation of interference pulses 1, 2, 6 and 7. (ref. ISO standard 7637).

The requirement for sophisticated switch control when generating ISO 7637 pulses is not immediately apparent. However, upon deeper examination it will become clear that the requirement for turning "ON" and "OFF" the battery power can only be met with a complicated solid state switch arrangement. This is because high power current needs to be switched over very short periods of time and by different control mechanisms.

Take for example pulse 1 of the ISO 7637-1 specification.

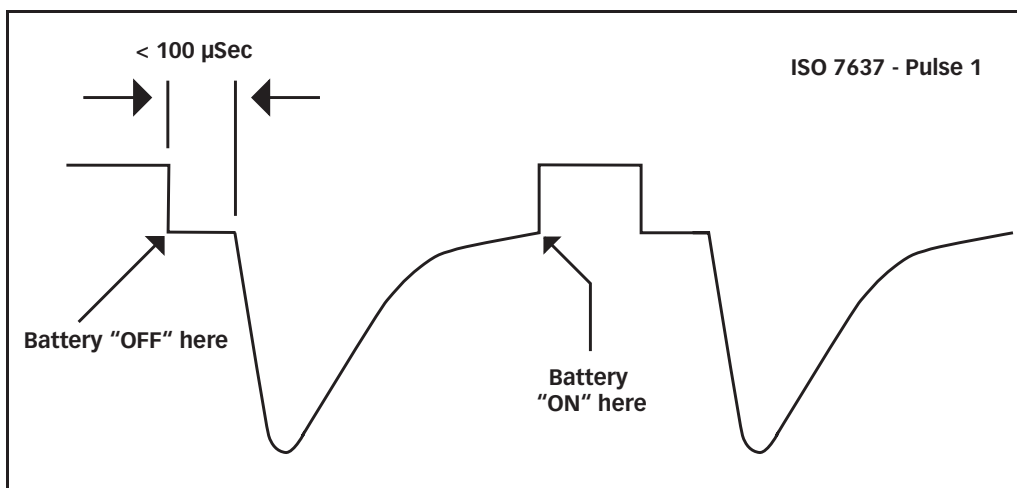

Picture 3-6: Pulse 1 of the ISO 7637-1 specification.

The voltage drop of the switch is minimal (see chapter 5.1 Technical specifications). The sense inputs are terminated at the switch, except in pulse 4 applications where the 4 continue through the output connector on the front panel of the FT 5531.

Upon detailed analysis of this pulse requirement it becomes clear that there is an implied requirement for the battery power to switch "ON" and "OFF" during pulse generation. The point at which the battery power is turned "ON" should really be determined by the voltage level of the pulse. Once it has decayed to a point of zero volts the battery power must be turned on rapidly and with minimal discontinuities.

A general block diagram of the CDN 5500 unit for the NSG 5500 system could be represented as follows.

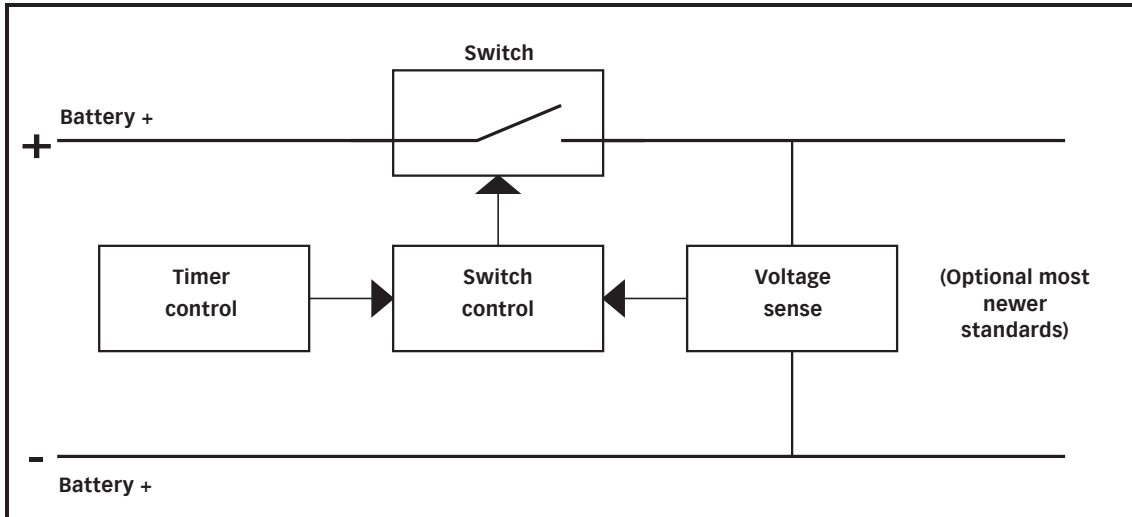

Picture 3-7: Block diagram of the CDN 5500 battery switch unit.

The switch has facilities for being controlled by a voltage sense circuit or a timer circuit. While it is obvious that the control of the battery switch to the required specification requires complicated timing and monitoring controls, all of this activity is generally transparent to the user. The control unit in the NSG 5500 manages all of these requirements internally and automatically, as required, during pulse generation.

3.2.3.2 Control unit

The control unit houses the processor board which controls the complete NSG 5500 system. The remote control interfaces are also mounted on this unit. The USB or RS 232 and IEEE 488 interfaces are supplied as standard on all NSG 5500 systems.

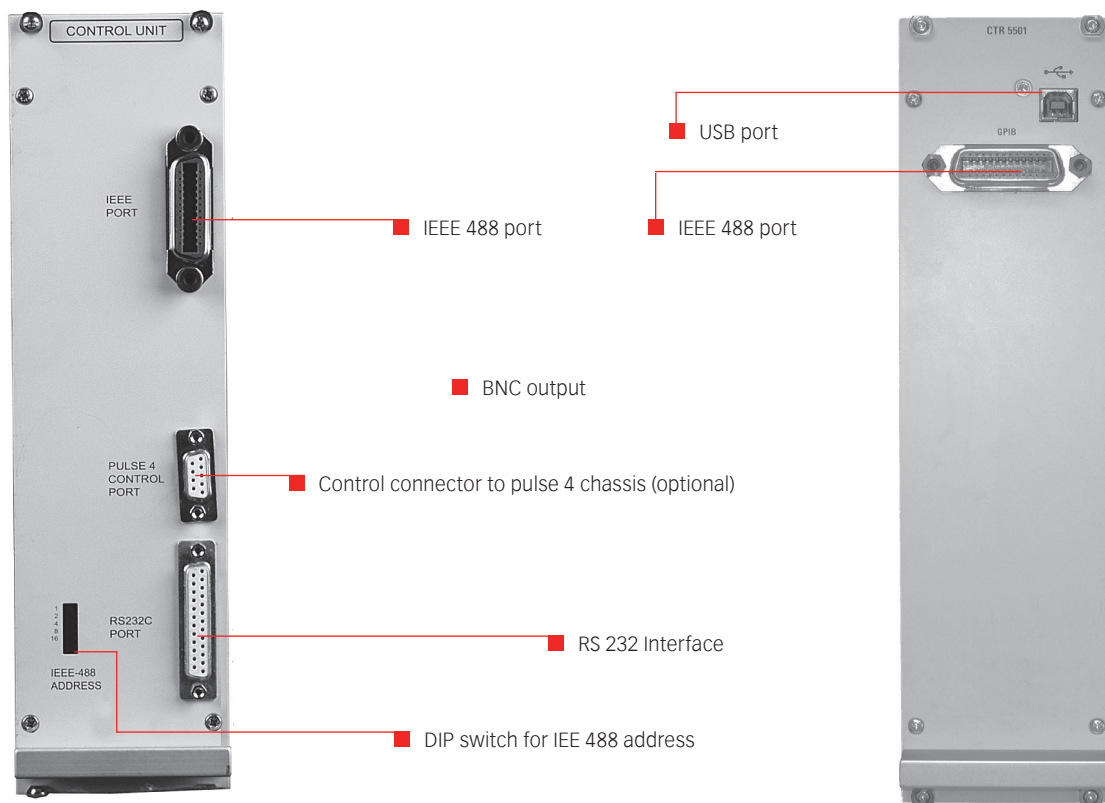

Picture 3-8: Control unit of the NSG 5500 with connectors

The optional Pulse 4 arbitrary waveform generator card may also be mounted within the control unit.



NOTE!

The pulse 4 control part is discontinued as of 2009.

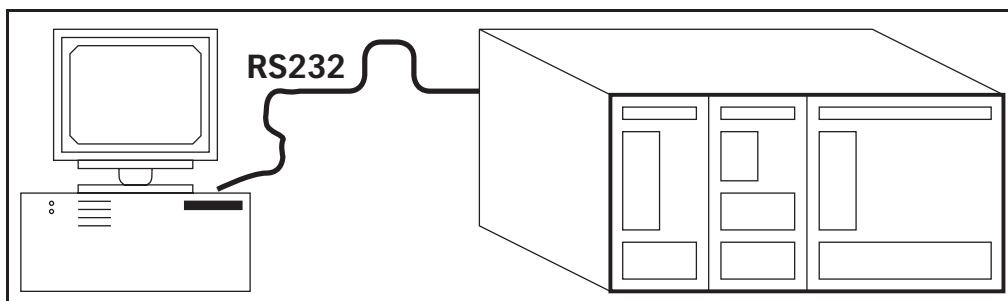

Picture 3-9: RS 232 Remote control of the NSG 5500.

Use of the IEEE 488 interface requires an interface to be fitted to the PC and the NSG 5500 chassis.

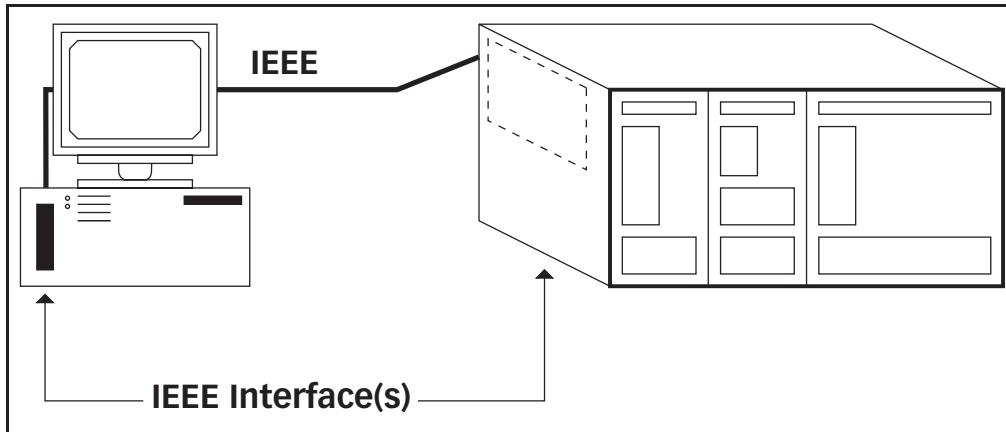

Picture 3-10: IEEE remote control of the NSG 5500

The remote control command syntax is identical in both interface methods and is SCPI based.



NOTE!

The Windows based application program «AutoStar» allows full remote control and test sequences to be developed within the graphical Windows environment.

The generator supports either USB or RS 232 and GPIB communication. The syntax of these commands is discussed in chapter 3.2.4 Remote programming. However, AutoStar is programmed with these commands and therefore, detailed understanding of the syntax is unnecessary unless the system is to be integrated into another software package other than AutoStar.

3.2.3.3 HV-supply

This unit is used to charge the pulse generators. It is a solid state electronic power supply that is capable of supplying the necessary high energy bursts of power required to charge all of the pulse generator capacitors used in modules contained in the NSG 5500 mainframe system.



The HV - supply is fully programmable and is controlled on the internal bus by the control unit.

Picture 3-11: HV supply of the NSG 5500.

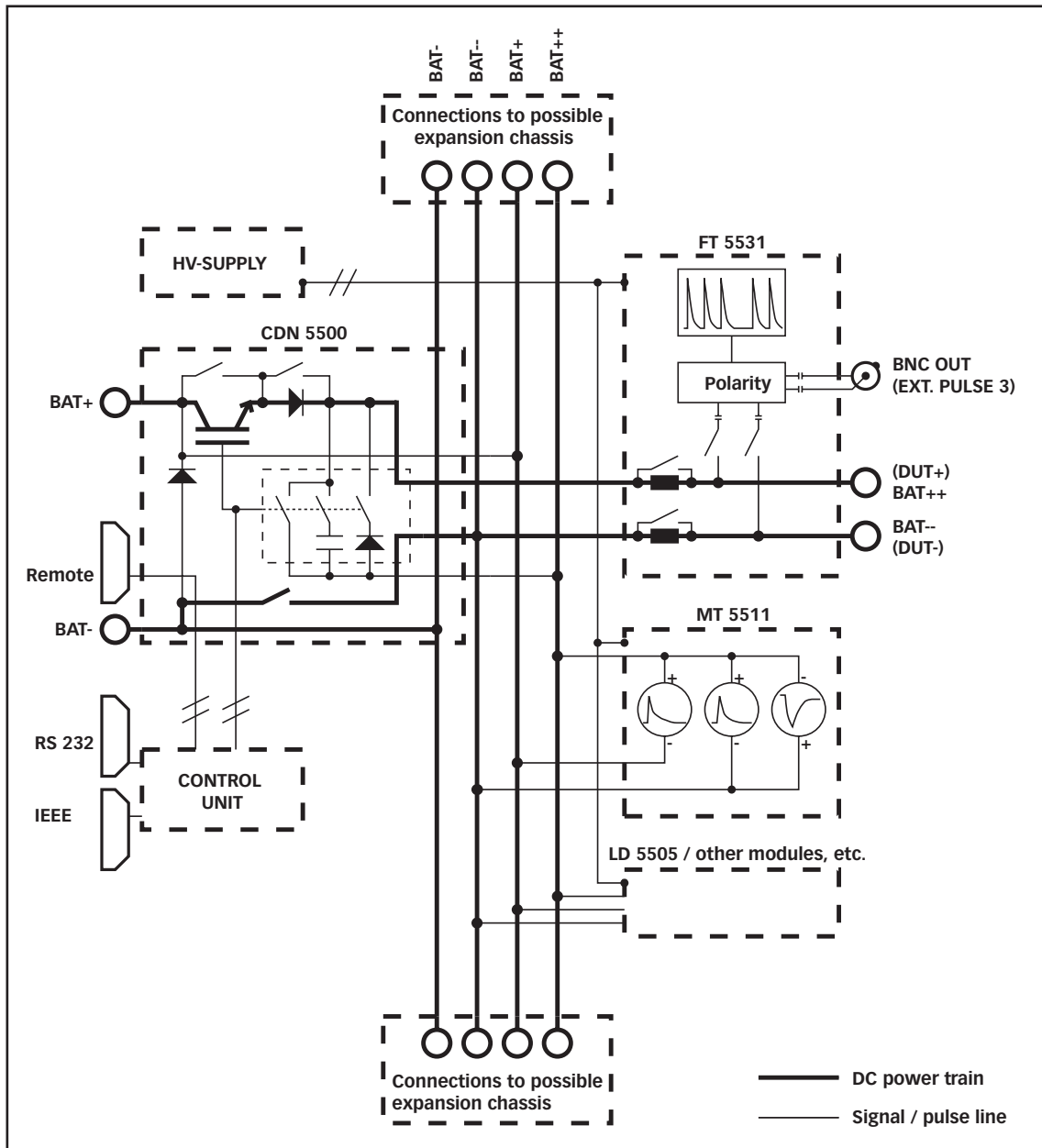

Picture 3-12: System block diagram of the NSG 5500.

3.2.4 Remote programming

A remote programming tools are available for advanced users who wish to program for their own special needs.



CAUTION!
These commands are for advanced users only!

The examples contained therein are generally for users who choose to write their own test software. Teseq can not be held responsible for improper use of these commands and/or syntax.

Please refer to the AutoStar communication logs during use for a complete understanding of the use of these commands.

3.2.5 External trigger and control signals

There are four input/output signals available on the rear of the NSG 5500 mainframe that can be used for synchronization with external equipment. The logic levels on these signals are as follows.

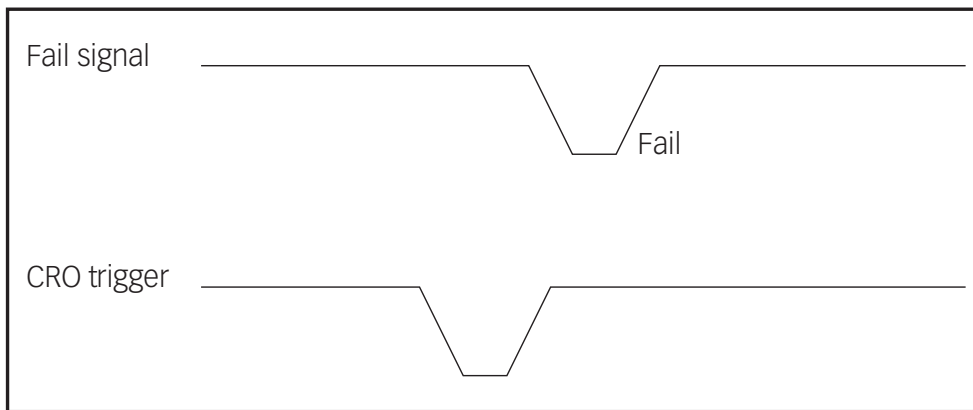

Picture 3-14: Logic levels on the signals of the NSG 5500

The signals are connected via a 9-pin D-Sub connector labelled "REMOTE" in the CDN 5500 panel. The pin assignment of this connector is as follows:

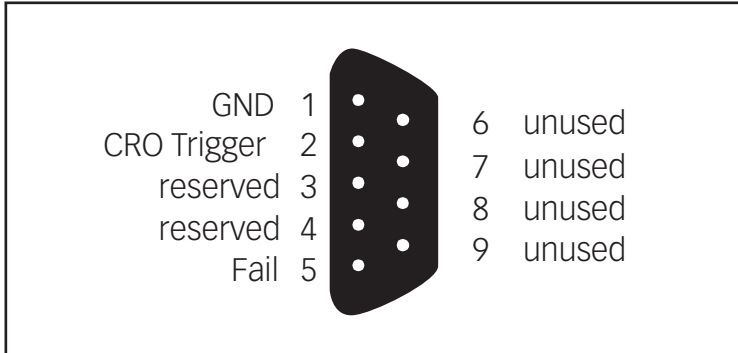

Picture 3-15: Pin assignment of the "REMOTE" connector on the rear side of the NSG 5500.

3.2.5.2 DUT FAIL signal

This is an input signal. It can be used to indicate that a DUT failure has occurred. Once this signal input is pulled low the present pulse generation pattern will be aborted and testing will end. The AutoStar software can automatically detect the state of the DUT FAIL signal input and will stop the program execution automatically if it detects a low signal.

The DUT FAIL input signal is optically isolated. The schematic for this input is as follows.

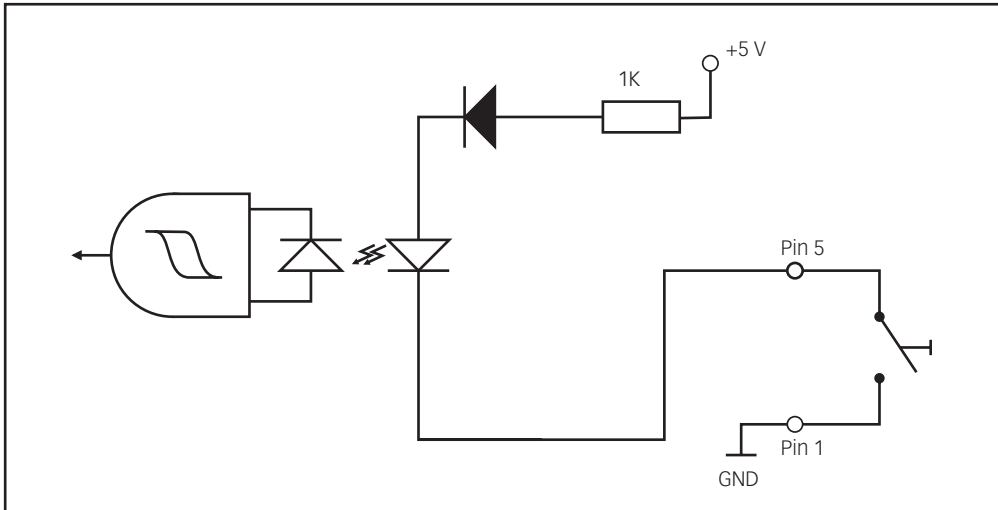

Picture 3-17: Schematic for the DUT FAIL signal input.

3.2.5.3 CRO trigger

This is an output signal. Its main purpose is for triggering an oscilloscope. The CRO trigger output will go low at the start of a pulse, or burst of pulses. If a burst of pulses is being generated with the 3a or 3b generators the trigger output will stay low for the duration of the burst. The CRO trigger is an optically isolated output and the schematic for this output is as follows.

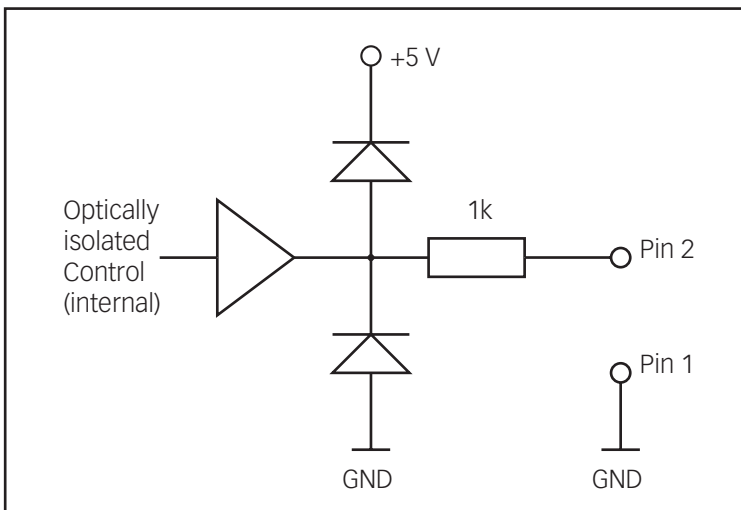

Picture 3-18: Schematic for the CRO trigger output signal.

Picture 3-19: Schematic for the test end signal.

3.2.6 RS 232 wiring diagram

An RS 232 interface cable may be supplied as standard with the NSG 5500 system. The relevant wiring diagram for this harness is as follows.

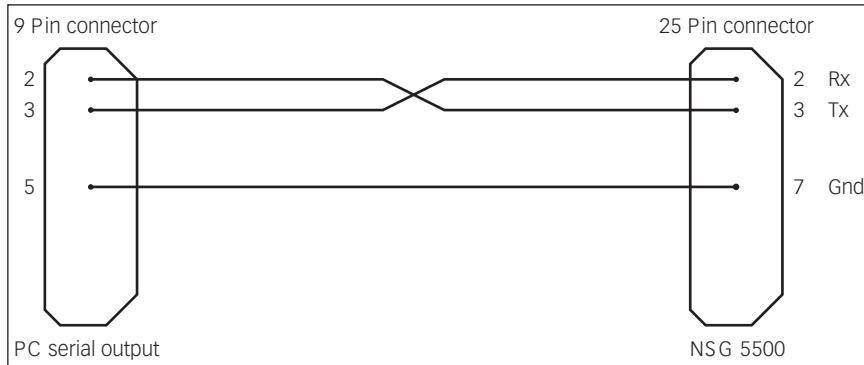

Picture 3-20: Wiring diagram for the RS 232 interface cable.

3.2.6.1 Optical interface

Because the primary function of the NSG 5500 Instrument is to generate interference pulses, the interference pulses may effect the communication link between the instrument and the PC, and corrupt the data being transferred.

For this reason, it is recommended when using the RS 232 link, to protect this link using two optically isolated interfaces, one at each end of the connecting cable. These interfaces, available from Teseq, will prevent corruption of the data by the interference pulses generated.

3.3 FT 5531 Operation

3.3.1 Introduction

The FT 5531 (**FT = Fast Transients**) is a plug-in burst generator designed for use with the NSG 5500 mainframe system. This generator is designed primarily to meet the specification requirements for the ISO 7637 standard for pulses 3a and 3b. In many cases the specification of this generator exceeds those specified in the ISO 7637 standard.

When slotted into an NSG 5500 mainframe, the FT 5531 burst generator is fully programmable via USB or RS 232 or IEEE 488 interface. Parameters such as amplitude, burst frequency, pulse frequency, number of pulses in the burst, number of bursts are all under program control. This allows flexible test patterns to be generated which can facilitate rapid analysis of susceptibility limits of a device under test.

The FT 5531 is designed using state of the art semi-conductor technology. This means repeatable performance and maintenance free operation. It also means that test results can be repeated accurately.

The output pulses of the generator are available on two connectors, a 50 Ohm BNC connector and a pair of 6 mm sockets. The 6 mm socket output has the added advantage in that it forms part of the multiplexed power bus within the NSG 5500 system. This means that output pulses for other plug-in units are also available on the socket output of the FT 5531 module. This can simplify fixturing to the device under test.



NOTE!

The AutoStar program available from Teseq is a Windows based graphical program which allows full control of all programmable features via an intuitive graphical windows front panel.

The BNC output connector must be chosen from AutoStar. NO CD is present at this connector and it is meant for pulse 3 only.

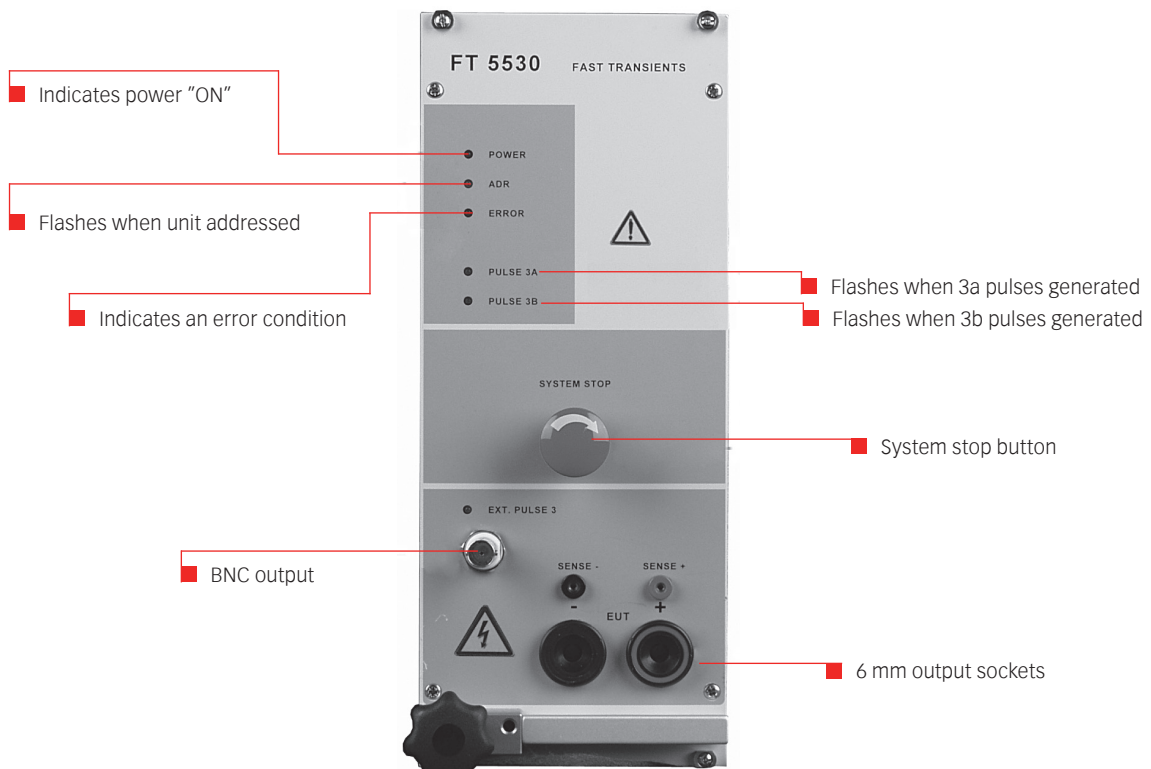

Picture 3-21: FT 5530 Front panel layout.

3.3.2 Block diagram

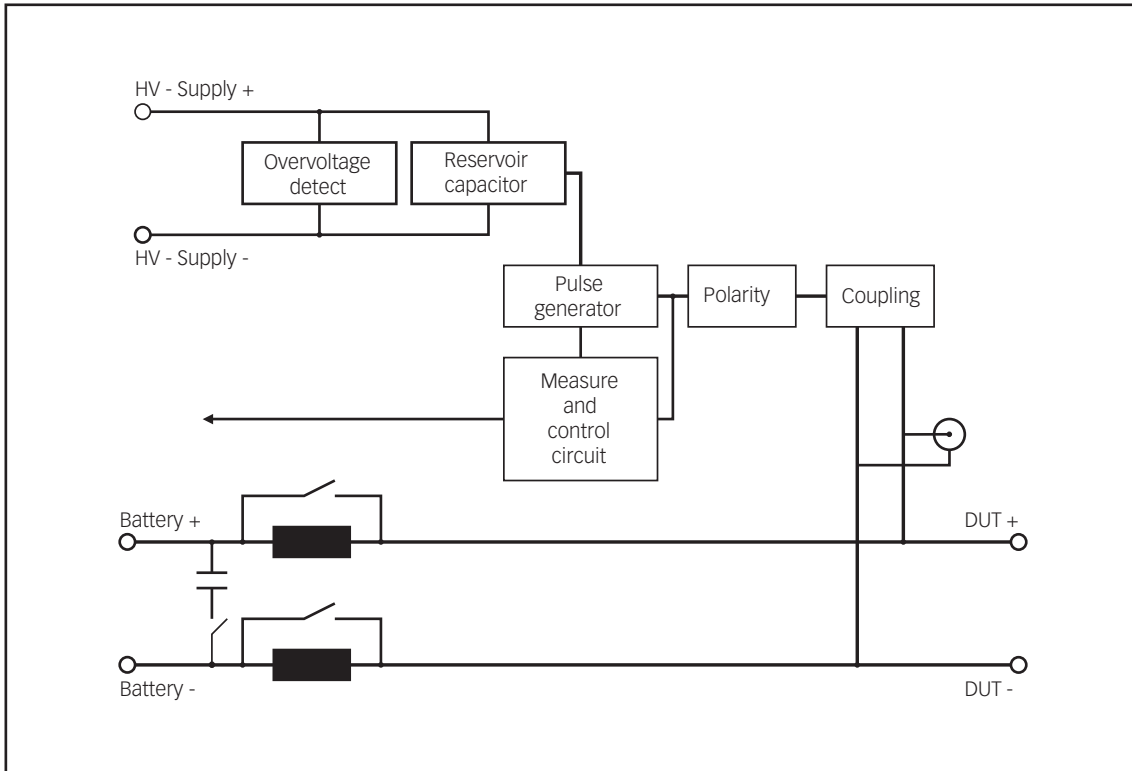

Picture 3-22: Block diagram of the FT 5531

3.3.3 Tests with a coupling clamp

A capacitive coupling clamp is used when the bursts have to be injected into control and data lines.

The following diagram illustrates the arrangement of the test rig recommended by ISO and DIN.

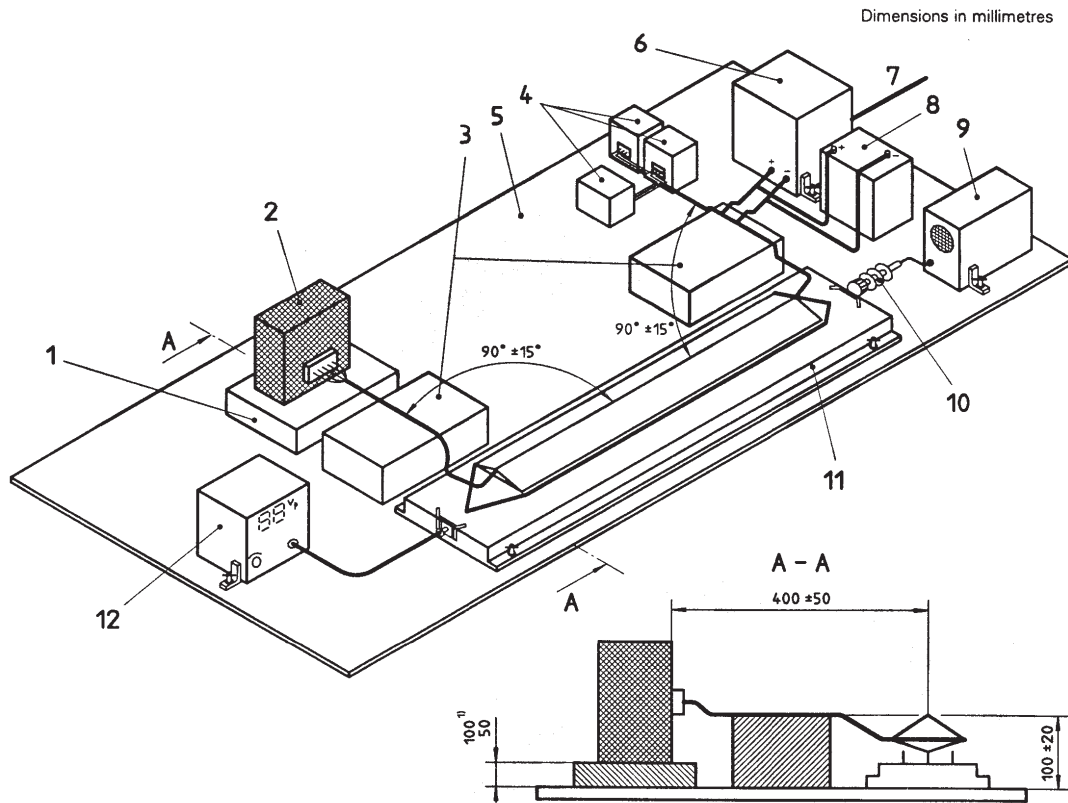

Picture 3-23: Arrangement of the test rig (dimensions in millimetres).

Key

1. Insulating support if device under test is not to be connected to ground in the vehicle
2. Device under test
3. Insulating supports for the test harness
4. Peripheral items (such as sensors, load, accessories) mounted as in the vehicle
5. Ground plane
6. Power supply 12 or 24 V
7. AC power supply
8. Battery
9. Oscilloscope
10. 50 Ω attenuator
11. Coupling clamp
12. Test pulse generator

A standard-conforming coupling clamp is available from Teseq under the type number CDN 500. The clamp has a 50 Ω BNC connector at both sides. The test circuit must be terminated with 50 Ω on the side opposite to the generator.

The termination and attenuator type INA 500 can be used for this purpose.

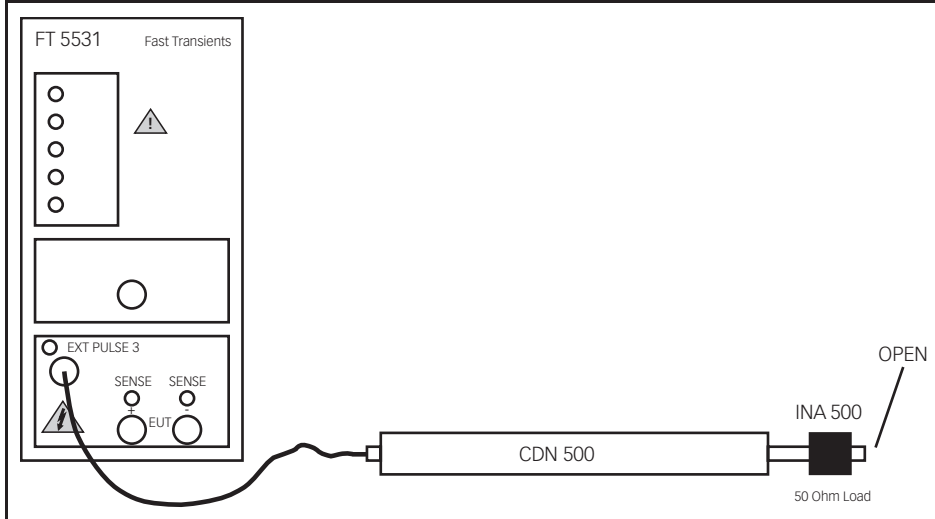

Picture 3-24: Arrangement with the FT 5531, CDN 500 and the INA 500 as a 50 Ω termination.

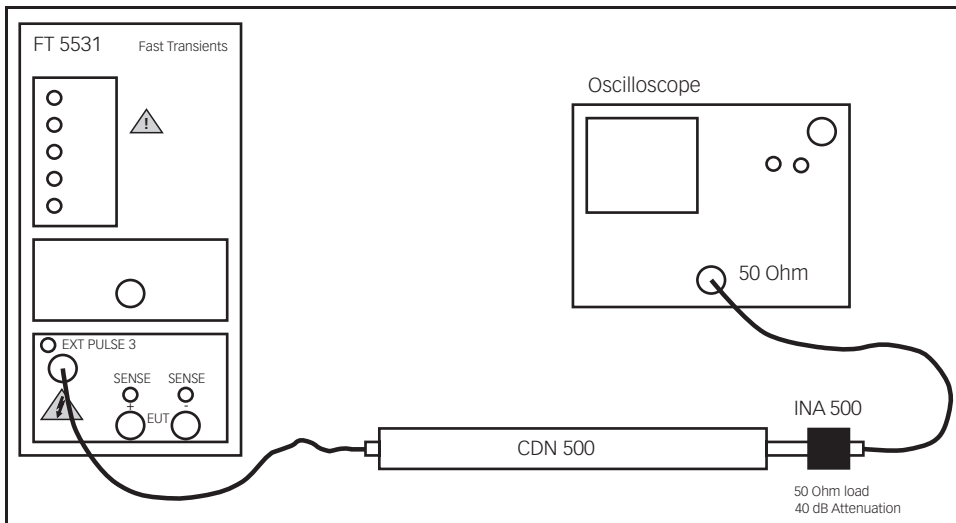

Picture 3-25: Arrangement with the FT 5531, CDN 500, INA 500 as a 50 Ω termination with integrated 40 dB attenuator and an oscilloscope.

In keeping with the specifications, the following relationships result during calibration measurements:

- Pulse at generator output: 120 V
- Pulse at 50 Ω connection: 60 V
- Pulse at the oscilloscope: 0.6 V

3.4 LD 5505 and LD 5550 Operation

3.4.1 Introduction

The LD 5505 and LD 5550 (**LD = Load Dump Generator**) are plug-in high energy generator modules designed for use with the NSG 5500 mainframe system. It is designed primarily to meet the specification requirements for the ISO 7637 standard for pulses 5 and 7. In many cases the specification of this generator exceeds those specified in the ISO 7637 standard.

When slotted into an NSG 5500 mainframe the LD module is fully programmable via USB or RS 232 and IEEE 488 interface. Parameters such as amplitude, pulse frequency, pulse width, are all under program control.

The LD 5550 and LD 5505 generates pulses of types 5, and 7, as specified in the ISO 7637 standard, which defines how these pulses are generated in relation to the vehicle battery voltage. When operating with a battery or battery simulator connected to the NSG 5500 mainframe, the CDN 5500 battery switch module should also be mounted in the rear of the NSG 5500 chassis. This module provides the necessary switching on and off of the battery voltage according to the standard.

The module is designed using state of the art active pulse-shaping technology. This means repeatable performance and maintenance free operation. It also means that test results can be repeated accurately.

The output pulses of the generator are available on two 6 mm sockets on the front of the NSG 5500 instrument.



NOTE!

The AutoStar program available from Teseq is a Windows based graphical program which allows full control of all programmable features via an intuitive graphical windows front panel.



NOTE!

Test files made with AutoStar are only compatible with the module they were written for LD 5550 or LD 5550.

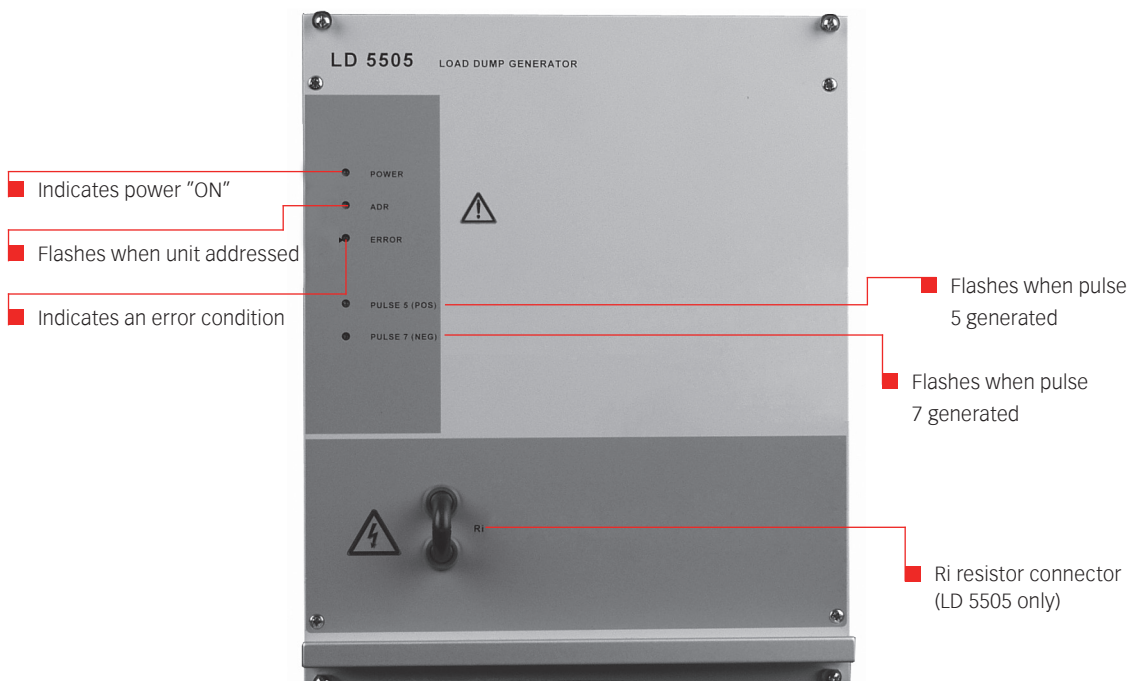

Picture 3-26: LD 5505 Front panel layout

3.4.2 Block diagram

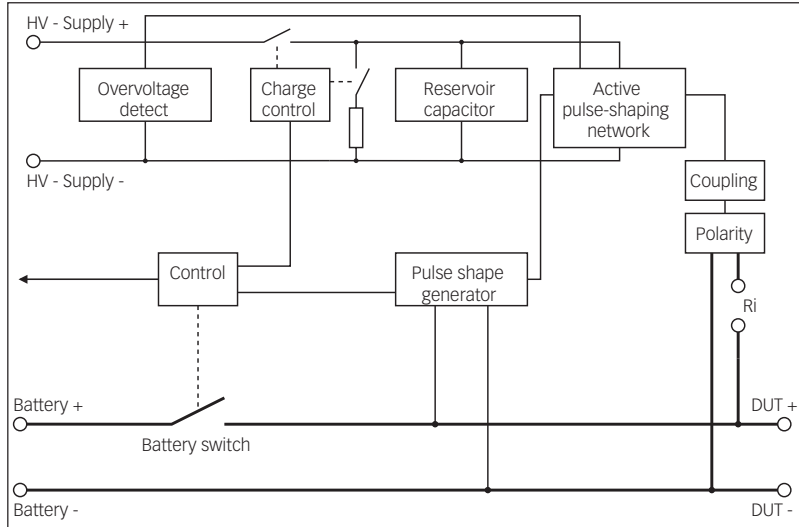

Picture 3-27: Block diagram of the LD 5505.

3.4.3 External output resistance (LD 5505 only)

The circuitry used within the LD 5505 module to generate pulse types 5 and 7, uses a solid state active circuit.

Using the AutoStar control software, the actual output current limit value can be set at between 1 and 120 Amps. If the application requires that the actual output resistance is necessary, the shorting plug on the Ri terminals of the LD 5505 module must be removed, and connections made from these terminals to the optional output resistance unit (INA 5025 or RM 5055) as shown below. In this mode, the output resistance unit is controlled by the control unit in the NSG 5500 mainframe system (via the BUS EXP connector on the power entry module).

The AutoStar control software can set the output resistance in this unit to between 0.5 and 10 ohms, in steps of 0.25 ohms. This resistance appears in series with the output of the pulse generation circuit of the LD 5505 module.

When using the LD 5505 unit with the INA 5025 external resistance unit, the output impedance of the LD 5505 itself is negligible.

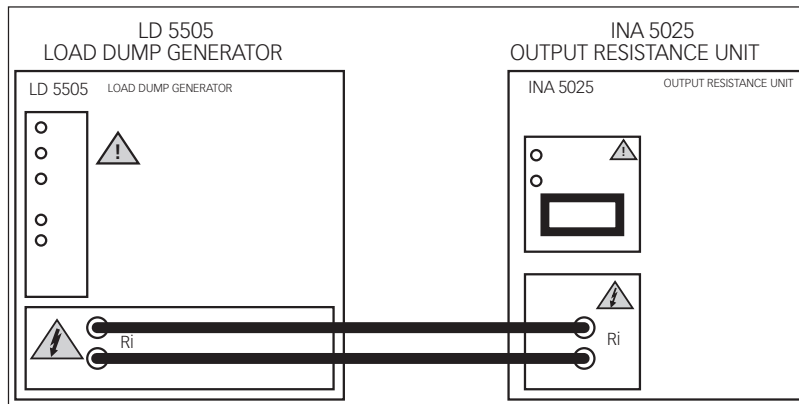

Picture 3-28: LD 5505 in combination with the INA 5025 external resistance.

NSG 5500 Automotive transient immunity generator

**CAUTION!**

When no external resistor or Teseq output resistance unit is used, the provided shorting connector must be installed.

**NOTE!**

The RM 5055 is also available. The difference between the INA 5025 and the RM 5055 is that the INA 5025 is an external unit, while the RM 5055 is meant to be installed into the NSG 5500. The INA 5025 is installed in the external INA 5026 chassis.

3.5 MT 5511 Operation

3.5.1 Introduction

The MT 5511 (MT = Micro Transients) is a plug-in transient generator module designed for use with the NSG 5500 mainframe system. This generator is designed to meet the specification requirements for the ISO 7637 standard for pulses 1, 2a, 6 and similar. In many cases the specification of this generator exceeds those specified in the applicable standard. The MT 5511 complies with ISO 7637-2:2004, with previous versions of the standard and also meets many proprietary automobile manufacturer standards.

The MT 5510 generates pulses of types 1, 2a and 6, as specified in the ISO, SAE and Ford™ standards. This standard defines how these pulses are generated in relation to the vehicle battery voltage.

When slotted into an NSG 5500 mainframe, the MT 5511 Micro transient generator is fully programmable either via USB or RS 232 and the IEEE 488 interface. Parameters such as amplitude, pulse width and pulse rise time are all under program control. This allows flexible test patterns to be generated, which can facilitate rapid analysis of susceptibility limits of a device under test.

The output pulses of the generator are available on two 6 mm sockets on the front of the NSG 5500 mainframe.

The MT 5511 allows selection of different internal output resistances under software control. If enabled in AutoStar, the Ri jacks will not internally be bypassed. This will allow to add an additional resistance to the selected internal pulse output resistor.

**NOTE!**

The AutoStar software program, available from Teseq, is a Windows based graphical program that allows full control of all programmable features via an intuitive graphical windows front panel.

System requirement	Min. version no
NSG 5500	
Auto Star	4.0
Firmware	7.0

Table 3-1: Minimum system requirements for use with the MT 5511.

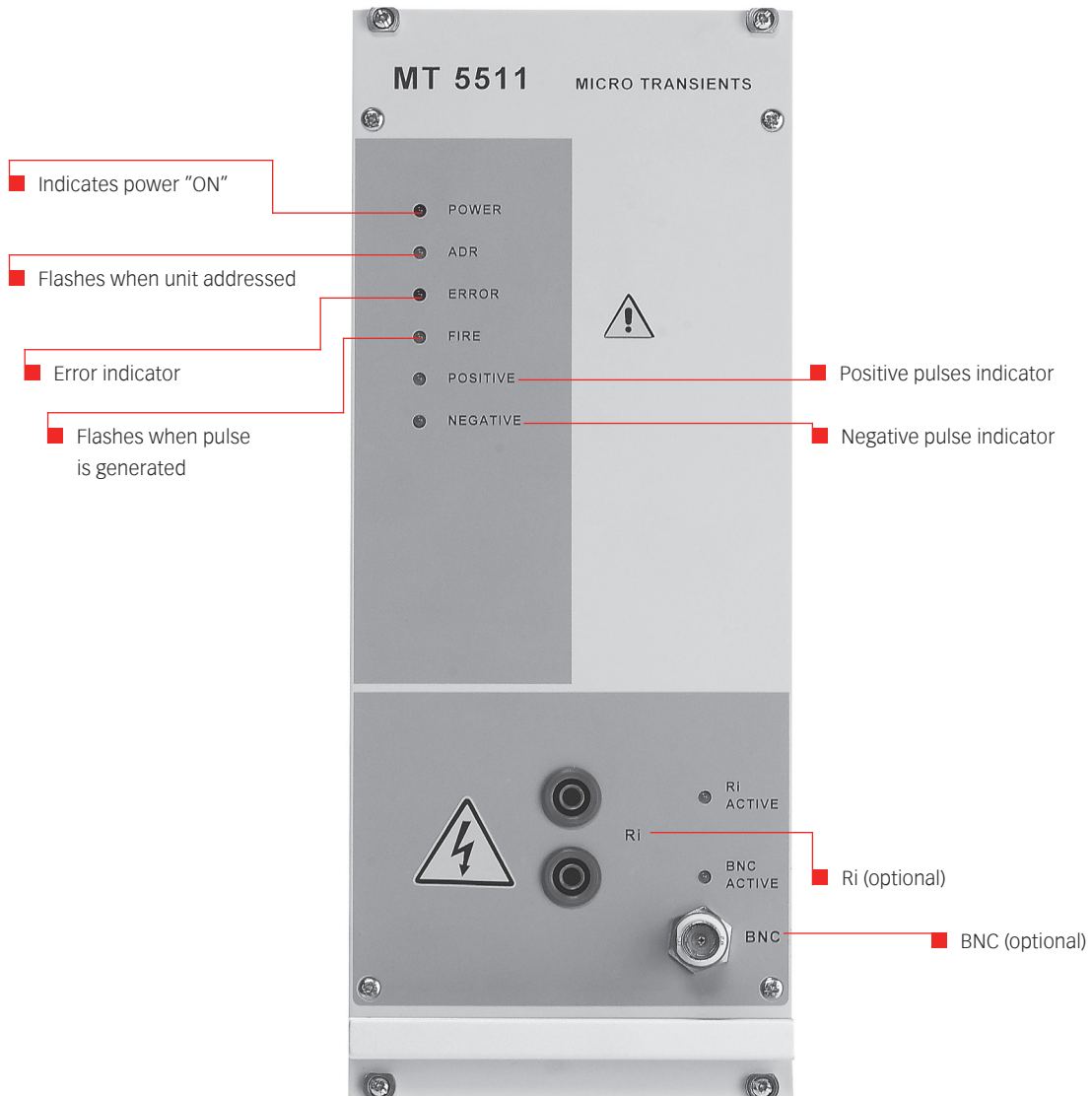

Picture 3-29: MT 5510 Front panel layout.

3.5.2 Block diagram

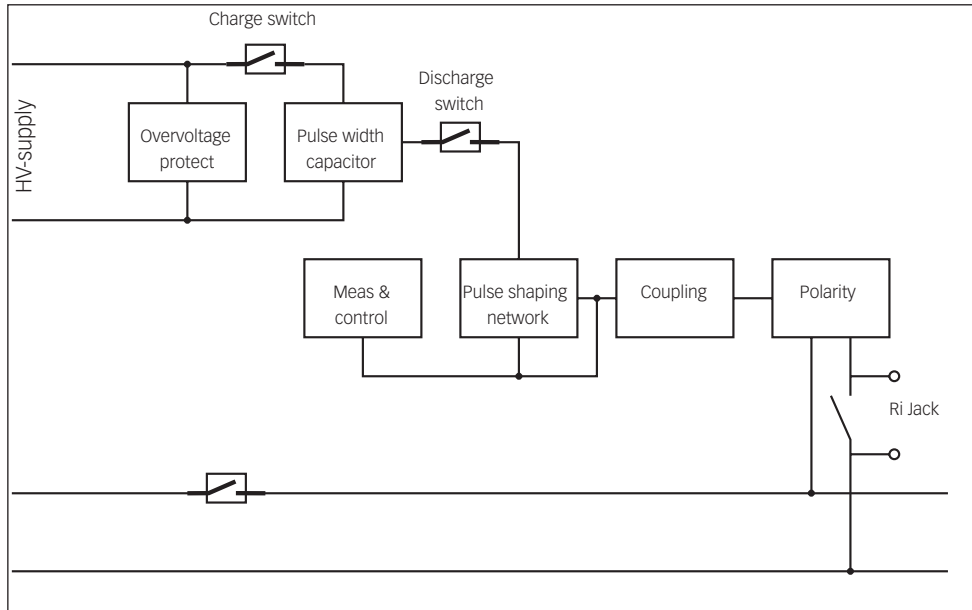

Picture 3-30: Block diagram of the MT 5511.

3.5.3 Transient diagram

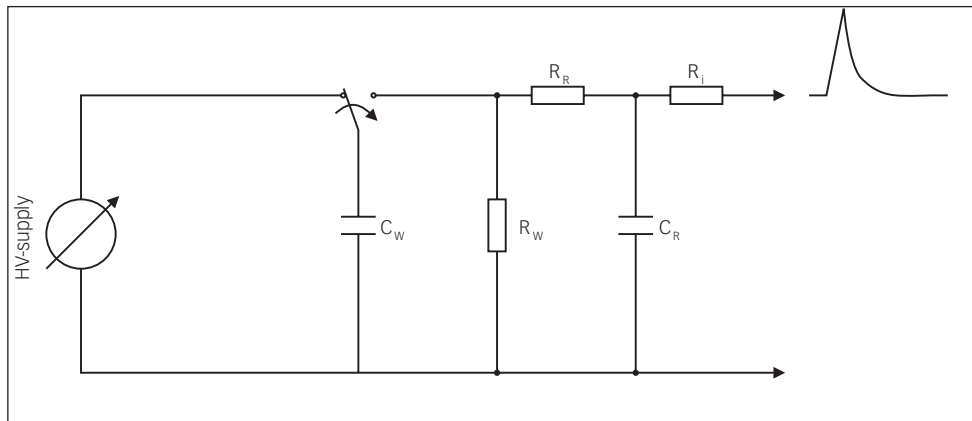

Picture 3-30: Block diagram of the MT 5511.

4 MAINTENANCE



Under normal conditions, it does not take much effort to keep your test equipment in good working order.



CAUTION!
Protect the equipment against moisture, heat and dust.

4.1 Cleaning the equipment

To clean the equipment, use a dry, clean cloth. Never use water, any other liquid or detergent.

4.2 Moving and storing the device

The device must be installed/uninstalled only by qualified personnel. Before moving the equipment (even over a short distance), you must first turn it off and disconnect it from the mains. Remove any fixturing devices and/or test objects. Also, disconnect the equipment from any peripherals. For longer transit, protect the equipment against humidity, dust and shock by proper packaging.

The equipment must be stored in upright (working) position. Make sure the equipment is protected against humidity, dust and dirt.

Observe the environmental conditions specified in chapter 5.3 Environmental conditions.

4.3 Protection

4.3.1 Magnetic circuit breaker

The NSG 5500 Main battery source Input is protected with a magnetic circuit breaker. The element is a slow breaker to allow high inrush currents. The specifications of the magnetic circuit breaker are as follows:
 100 A / 300 A_{peak} (200 ms)

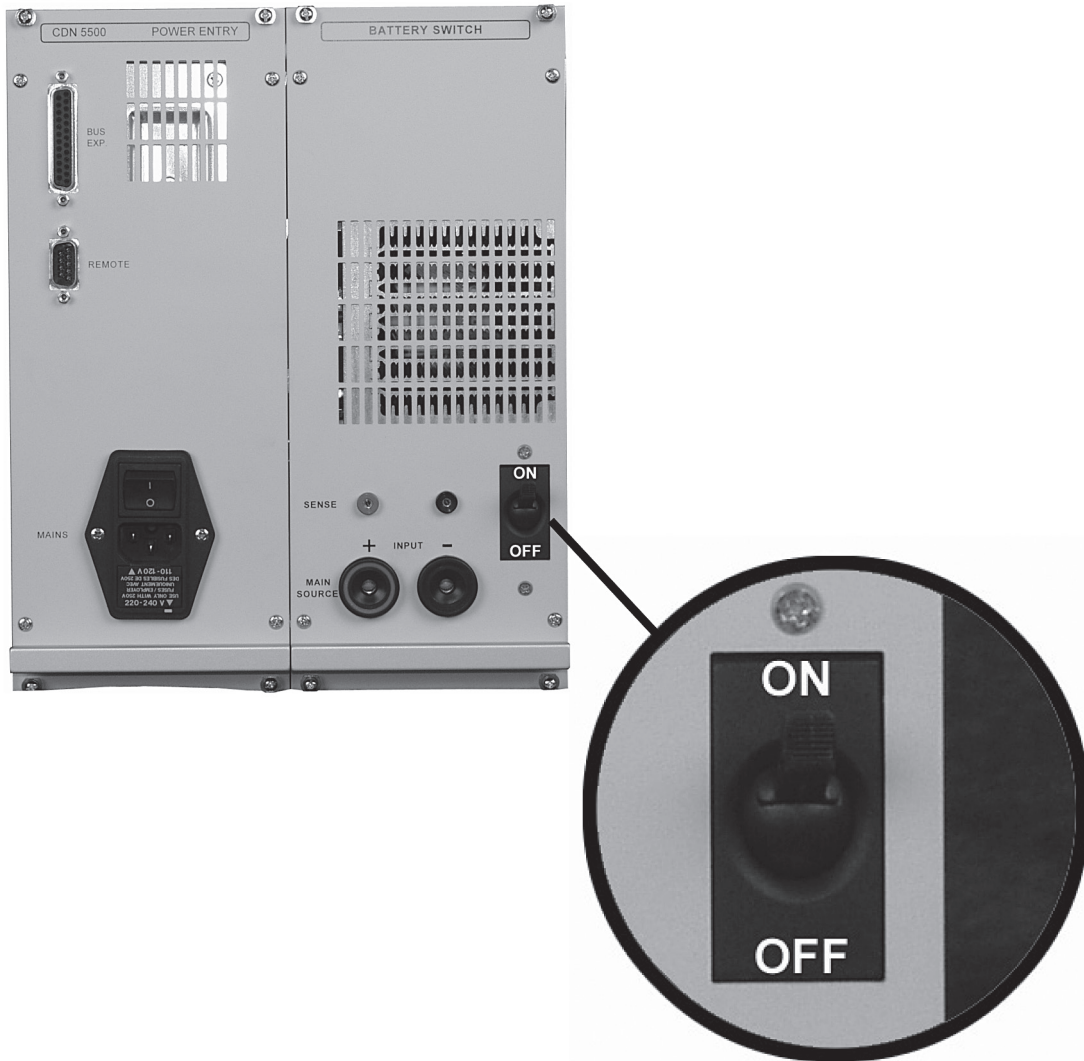

Picture 4-1: The magnetic circuit breaker in the CDN 5500 unit.

4.3.2 Fuses

The fuses are placed in the mains voltage selector. To exchange a fuse, proceed as follows:



DANGER!

The NSG 5500 must be disconnected from the mains by disconnecting the power cord before working on the mains voltage selector!

- Carefully loosen the drawer from the input connector assembly using a screwdriver and turning it slightly in both directions as shown in the picture below.

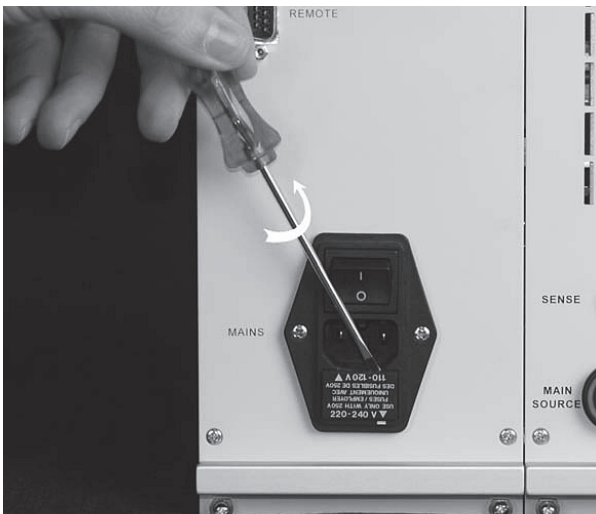

Picture 4-2: Loosen the drawer using a screwdriver.

- Pull out the drawer from the input connector assembly



Picture 4-3: Pull out the drawer.

- Remove the defect fuse(s)...

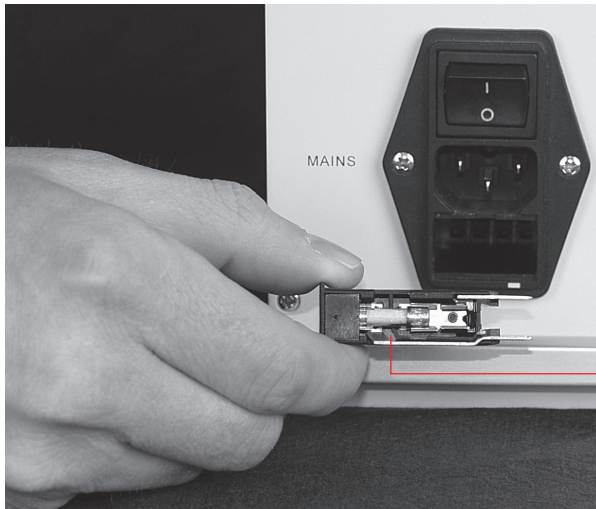

- The defect fuse on the side of the drawer

Picture 4-4: The Fuses are placed on the sides of the drawer.

- ...probably carefully using a small screwdriver



Picture 4-5: Remove defect fuses.

- Remove the defect fuse(s)...

**CAUTION!**

Use the following fuse types for the appropriate voltage ranges:

110–120 V: 5 x 20 mm, 6.3 A, time-lag

220–240 V: 5 x 20 mm, 3.15 A, time-lag

Take care to install the drawer to the correct voltage range when reinstalling the drawer into the input connector assembly.



Picture 4-6: Push the drawer back in.

- ...until it is fixed to the input connector assembly again



Picture 4-7: Fix the drawer to the input connector assembly.

- Now reconnect the NSG 5500 to the mains.

4.4 Declaration of conformity CE

61



Teseq AG Nordstrasse 11F 4542 Luterbach Switzerland
T+41 32 681 40 40 F+41 32 681 40 48 www.teseq.com

Declaration of conformity



Manufacturer: Teseq AG
Address: Nordstrasse 11F, 4542 Luterbach, Switzerland
declares that the following product
Product: NSG 5500 Automotive Transient Immunity Generator
Options: all
conforms to the following Directives and Regulations
EMC Directive 2004/108/EEC
LVD Directive 2006/95/EEC
Generic standards: EN61326-1, 2005
EN61326-2-1, 2005
EN61010-1, 2001
The relevant technical file is available for inspection:
Technical file: N° EMC_NSG5500_2006 / LVD_NSG5500_2006
Teseq AG
CH - 4542 Luterbach

The purpose of this instrument is the generation of defined interference signals for EMI immunity testing. Depending on the arrangement of the test rig, the configuration, the cabling and the properties of the EUT itself, a significant amount of electromagnetic radiation may result that could also affect other equipment and systems. The user himself or herself is ultimately responsible for the correct and controlled operation of the rig. In case of doubt, the tests should be carried out in a Faraday cage.

European representative: Teseq GmbH, Landsberger Str. 255, 12623 Berlin, Germany

Place and Date: Luterbach, December 12th, 2006



Johannes Schmid
President

5 TECHNICAL DATA



5.1 Technical specifications

5.1.1 NSG 5500

Instrument power supply:	100 to 120 VAC \pm 10%, 47 - 63 Hz 220 to 240 VAC \pm 10%, 47 - 63 Hz
DUT supply:	From an external source, e.g. battery or PA 5840 power amplifier / battery simulator
Computer interface:	IEEE 488 (recommended) USB or RS 232
Auxiliary input signals:	DUT FAIL / START-STOP CRO-TRIG / TEST-END
Auxiliary output signals:	60 V max.
Input DC voltage range:	100 A (250 A for 200 ms)
DC current:	< 2 V @ 100 A
Voltage drop of battery:	~ 1.5 V @ 25 A
Switch:	(for positive serial coupled pulses in battery mode upc (under program control): 3.5 V @ 100 A)
Battery switch on/off time:	~ 2 μ s (1 Ω load) IP20
Protection class:	IP20

5.1.2 MT 5510

Micro transient generator for the pulses 1, 2, 6 and variants.

Pulse	Voltage range (V)	Rise tim	Pulse width	Internal Ri (Ω)	Repetition rate t1 (s)	Polarity	Ext. Ri available
Pulse 1	0-330 (1 V steps)	1 μ s, 2 μ s, 3 μ s	2 ms, 6 ms	40, 10, 20, 30, 50, 90	0,5-60 (0,01 steps)	Neg., Pos.	NO
	0-200 (1 V steps)	1 μ s	2 ms	10	0,5-60 (0,01 steps)	Neg., Pos.	No
	0-600 (1 V steps)	1 μ s, 3 μ s	1 ms	20, 50	0,5-60 (0,01 steps)	Neg., Pos., BNC	Yes
Pulse 1 (24 V)	0-600 (1 V steps)	1 μ s, 3 μ s	2 ms, 2.3 ms	10, 20, 30, 50	0,5-60 (0,01 steps)	Neg., Pos., BNC	Yes
Pulse 2a	0-330 (1 V steps)	1 μ s	50 μ s	2, 4, 10, 20, 50, 90	0,5-60 (0,01 steps)	Neg., Pos., BNC	Yes
Pulse 6	0-330 (1 V steps)	60 μ s	300 μ s	30	0,5-60 (0,01 steps)	Neg., Pos., BNC	Yes
Others	0-330 (1 V steps)	1 μ s	50 μ s, 35 μ s	2, 50	0,5-60 (0,01 steps)	Neg., Pos., BNC	Yes
	0-330 (1 V steps)	1 μ s	50 μ s, 150 μ s, 200 μ s, 350 μ s	40, 10, 30	0,5-60 (0,01 steps)	Neg., Pos., BNC	Yes
	0-330 (1 V steps)	2 μ s	50 μ s	10	0,5-60 (0,01 steps)	Neg., Pos., BNC	Yes

Table 5-1: Technical specifications MT 5510

Note! Repetition rate of 0.2 are only valid for negative pulses or positive pulses with batter "ON".

Note! Pulse 1 and pulse 2a are used here for easy reference. All pulses from the MT 5511 can be both positive or negative.

NSG 5500 Automotive transient immunity generator

5.1.3 LD 5505

Load dump generator for pulse 5 and clamped load dump pulse 5b.

Pulse amplitude:	20 to 200 V in 0.5 V steps
Clamping:	15 to 100 V
Impedance:	According to resistor installed, the optional RM 5505 has available 0.5 to 10 Ω in 0.25 Ω steps
Pulse rise time:	0.1 to 10 ms
Pulse duration:	30 to 700 ms in 1 ms steps
Pulse repetition:	20 to 600 s in 0.1 s steps
Pulse modes:	Single, continuous, programmed 1 to 99,999

5.1.4 LD 5550

Load dump generator for pulse 5 and clamped load dump pulse 5b.

Pulse amplitude:	20 to 200 V in 0.1 V steps $\pm 5\%$
Clamping:	10 to 100 V $\pm 5\%$ Pulse 5b overshoot typ. $< 2\%/2V$
Impedance (Ri):	0.5 to 10 Ω in 0.25 Ω steps; 30.5 Ω , 40 Ω $\pm 10\%$
Pulse rise time:	0.5 to 10 ms $\pm 10\%$ < 0.5 ms ($\pm 10\% + 50\mu s$) $\pm 10\%$ ≥ 50 V pulse amplitude $\pm 20\%$ $< 50V$ pulse amplitude
Pulse repetition:	15 to 600 s in 0.1 s steps, pulse repetition depends on pulse energy
Pulse modes:	Single, continuous, programmed 1 to 9,999

5.1.5 FT 5530

Fast transients generator for the ISO pulse 3a/3b and variants.

Pulse amplitude:	20 to 800 V in 1 V steps (lower voltages are also programmable)
Impedance:	50 Ω
Pulse rise time tr:	5 ns ± 1.5 ns for td= 150 ns, < 5 ns for td= 100 ns
Pulse duration td:	100 ns (-10%... +20%*) and 150 ns $\pm 20\%$
Burst frequency:	1 to 100 kHz in 0.1 kHz steps
Pulses per burst:	1 to 200
Burst repetition:	90 ms to 99.9 s in 10 ms steps
Pulse modes:	Single, continuous, programmed 1 to 99,999

*) $\pm 20\%$ for pulse amplitudes < 25 V

5.1.6 FT 5531

Fast transients generator for the ISO pulse 3a/3b and variants

	EUT Out 150 ns	BNC Out 150 ns	EUT Out 100 ns	BNC Out 100 ns
Pulse Amplitude	50* – 800V ($\pm 10\%$)	50* – 600V ($\pm 10\%$)	50* – 600V ($\pm 10\%$)	50* – 600V ($\pm 15\%$)
Impedance*	50 Ω			
Pulse Rise Time	5 ns ($\pm 30\%$)			
Pulse Width	150 ns ($\pm 20\%$)		100ns ($\pm 10\%$)	
Burst Frequency	1 – 100 kHz in 0.1 kHz steps			
Burst Interval	0.01 to 99.9 ms			
Pulses per Burst	1 – 200			
Burst Repetition	90 ms – 99.9 s in 10 ms steps			
Pulse Modes	Single, continuous, programmed			

*Lower voltage also programmable

System Requirements: NSG 5500 with the new CTR 5501, AutoStar 6.2. Package Upgrades Available on Request.

**CAUTION!**

The FT 5531 is only compatible with AutoStar 6.2 and above. Failure to use AutoStar 6.2 and above may result in severe damage to the system!

5.2 Measures and weight

Dimensions:	NSG 5500-1: 19" desktop housing (rack mountable), height 330 mm (13"), depth 510 mm (20") NSG 5500-2: 9" desktop housing (rack mountable), height 640 mm (25.2"), depth 510 mm (20")
Weight (incl. HV-supply, CDN 5500, control unit,	NSG 5500-1: ~36 kg NSG 5500-2: ~37 kg (without additional modules) MT 5511, FT 5530, LD 5505)

5.3 Environmental Conditions

Temperatur range:	Operation at +10 to +40°C Storage at -10 to +60°C
Humidity:	30 to 78% (non condensing)
Air pressure:	860 to 1060 hPa

Headquarters**Teseq AG**

4542 Luterbach, Switzerland

T +41 32 681 40 40

F +41 32 681 40 48

sales@teseq.com

www.teseq.com**China****Teseq Company Limited**

T +86 10 8460 8080

F +86 10 8460 8078

chinasales@teseq.com

Germany**Teseq GmbH**

T +49 30 5659 8835

F +49 30 5659 8834

desales@teseq.com

Singapore**Teseq Pte Ltd.**

T +65 6846 2488

F +65 6841 4282

singaporesales@teseq.com

Taiwan**Teseq Ltd.**

T +886 2 2917 8080

F +886 2 2917 2626

taiwansales@teseq.com

USA**Teseq Inc.**

T +1 732 417 0501

F +1 732 417 0511

Toll free +1 888 417 0501

usasales@teseq.com

Manufacturer**Teseq AG**

4542 Luterbach, Switzerland

T +41 32 681 40 40

F +41 32 681 40 48

sales@teseq.com

France**Teseq Sarl**

T +33 1 39 47 42 21

F +33 1 39 47 40 92

francesales@teseq.com

Japan**Teseq K.K.**

T +81 3 5725 9460

F +81 3 5725 9461

japansales@teseq.com

Switzerland**Teseq AG**

T +41 32 681 40 50

F +41 32 681 40 48

sales@teseq.com

UK**Teseq Ltd.**

T +44 845 074 0660

F +44 845 074 0656

uksales@teseq.com

To find your local partner within Teseq®'s global network, please go to **www.teseq.com**
© September 2011 Teseq®

Specifications subject to change without notice. Teseq® is an ISO-registered company. Its products are designed and manufactured under the strict quality and environmental requirements of the ISO 9001. This document has been carefully checked. However, Teseq® does not assume any liability for errors or inaccuracies.