

**Sorensen**  
**DCS-E 3kW Series DC**  
**Power Supplies**  
Operation Manual

This manual covers models:

DCS8-350E	DCS55-55E
DCS12-250E	DCS60-50E
DCS20-150E	DCS80-37E
DCS40-75E	DCS150-20E







## **About AMETEK**

AMETEK Programmable Power, Inc., a Division of AMETEK, Inc., is a global leader in the design and manufacture of precision, programmable power supplies for R&D, test and measurement, process control, power bus simulation and power conditioning applications across diverse industrial segments. From bench top supplies to rack-mounted industrial power subsystems, AMETEK Programmable Power is the proud manufacturer of Elgar, Sorensen, California Instruments and Power Ten brand power supplies.

AMETEK, Inc. is a leading global manufacturer of electronic instruments and electromechanical devices with annualized sales of \$2.5 billion. The Company has over 11,000 colleagues working at more than 80 manufacturing facilities and more than 80 sales and service centers in the United States and around the world.

## **Trademarks**

AMETEK is a registered trademark of AMETEK, Inc.

Other trademarks, registered trademarks, and product names are the property of their respective owners and are used herein for identification purposes only.

## **Notice of Copyright**

*DCS-E 3kW Series DC Power Supplies Operation Manual* © 2006-2008 AMETEK Programmable Power, Inc. All rights reserved.

## **Exclusion for Documentation**

UNLESS SPECIFICALLY AGREED TO IN WRITING, AMETEK PROGRAMMABLE POWER, INC. ("AMETEK"):

- (a) MAKES NO WARRANTY AS TO THE ACCURACY, SUFFICIENCY OR SUITABILITY OF ANY TECHNICAL OR OTHER INFORMATION PROVIDED IN ITS MANUALS OR OTHER DOCUMENTATION.
- (b) ASSUMES NO RESPONSIBILITY OR LIABILITY FOR LOSSES, DAMAGES, COSTS OR EXPENSES, WHETHER SPECIAL, DIRECT, INDIRECT, CONSEQUENTIAL OR INCIDENTAL, WHICH MIGHT ARISE OUT OF THE USE OF SUCH INFORMATION. THE USE OF ANY SUCH INFORMATION WILL BE ENTIRELY AT THE USER'S RISK, AND
- (c) REMINDS YOU THAT IF THIS MANUAL IS IN ANY LANGUAGE OTHER THAN ENGLISH, ALTHOUGH STEPS HAVE BEEN TAKEN TO MAINTAIN THE ACCURACY OF THE TRANSLATION, THE ACCURACY CANNOT BE GUARANTEED. APPROVED AMETEK CONTENT IS CONTAINED WITH THE ENGLISH LANGUAGE VERSION, WHICH IS POSTED AT [WWW.PROGRAMMABLEPOWER.COM](http://WWW.PROGRAMMABLEPOWER.COM).

## **Date and Revision**

December 2008 Revision B

## **Part Number**

M362295-01



## **Contact Information**

Telephone: 800 733 5427 (toll free in North America)  
858 450 0085 (direct)  
Fax: 858 458 0267  
Email: [sales@programmablepower.com](mailto:sales@programmablepower.com)  
[service@programmablepower.com](mailto:service@programmablepower.com)  
Web: [www.programmablepower.com](http://www.programmablepower.com)

This page intentionally left blank.

# Important Safety Instructions

Before applying power to the system, verify that your product is configured properly for your particular application.

	<b>Hazardous voltages may be present when covers are removed. Qualified personnel must use extreme caution when servicing this equipment. Circuit boards, test points, and output voltages also may be floating above (below) chassis ground.</b>
	<b>The equipment used contains ESD sensitive parts. When installing equipment, follow ESD Safety Procedures. Electrostatic discharges might cause damage to the equipment.</b>

Only *qualified personnel* who deal with attendant hazards in power supplies, are allowed to perform installation and servicing.

Ensure that the AC power line ground is connected properly to the Power Rack input connector or chassis. Similarly, other power ground lines including those to application and maintenance equipment *must* be grounded properly for both personnel and equipment safety.

Always ensure that facility AC input power is de-energized prior to connecting or disconnecting any cable.

In normal operation, the operator does not have access to hazardous voltages within the chassis. However, depending on the user's application configuration, **HIGH VOLTAGES HAZARDOUS TO HUMAN SAFETY** may be normally generated on the output terminals. The customer/user must ensure that the output power lines are labeled properly as to the safety hazards and that any inadvertent contact with hazardous voltages is eliminated.

Guard against risks of electrical shock during open cover checks by not touching any portion of the electrical circuits. Even when power is off, capacitors may retain an electrical charge. Use safety glasses during open cover checks to avoid personal injury by any sudden component failure.

Neither AMETEK Programmable Power Inc., San Diego, California, USA, nor any of the subsidiary sales organizations can accept any responsibility for personnel, material or inconsequential injury, loss or damage that results from improper use of the equipment and accessories.

## SAFETY SYMBOLS

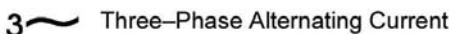
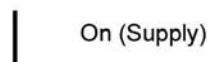
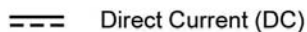
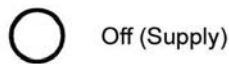
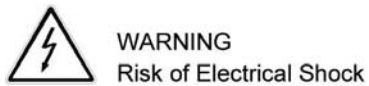

This page intentionally left blank.



## Product Family: DCS-E 3kW Series DC Power Supplies

Warranty Period: Five Years

### WARRANTY TERMS

AMETEK Programmable Power, Inc. ("AMETEK"), provides this written warranty covering the Product stated above, and if the Buyer discovers and notifies AMETEK in writing of any defect in material or workmanship within the applicable warranty period stated above, then AMETEK may, at its option: repair or replace the Product; or issue a credit note for the defective Product; or provide the Buyer with replacement parts for the Product.

The Buyer will, at its expense, return the defective Product or parts thereof to AMETEK in accordance with the return procedure specified below. AMETEK will, at its expense, deliver the repaired or replaced Product or parts to the Buyer. Any warranty of AMETEK will not apply if the Buyer is in default under the Purchase Order Agreement or where the Product or any part thereof:

- is damaged by misuse, accident, negligence or failure to maintain the same as specified or required by AMETEK;
- is damaged by modifications, alterations or attachments thereto which are not authorized by AMETEK;
- is installed or operated contrary to the instructions of AMETEK;
- is opened, modified or disassembled in any way without AMETEK's consent; or
- is used in combination with items, articles or materials not authorized by AMETEK.

The Buyer may not assert any claim that the Products are not in conformity with any warranty until the Buyer has made all payments to AMETEK provided for in the Purchase Order Agreement.

### PRODUCT RETURN PROCEDURE

1. Request a Return Material Authorization (RMA) number from the repair facility (**must be done in the country in which it was purchased**):
  - **In the USA**, contact the AMETEK Repair Department prior to the return of the product to AMETEK for repair:  
Telephone: 800-733-5427, ext. 2295 or ext. 2463 (toll free North America)  
858-450-0085, ext. 2295 or ext. 2463 (direct)
  - **Outside the United States**, contact the nearest Authorized Service Center (ASC). A full listing can be found either through your local distributor or our website, [www.programmablepower.com](http://www.programmablepower.com), by clicking Support and going to the Service Centers tab.
2. When requesting an RMA, have the following information ready:
  - Model number
  - Serial number
  - Description of the problem

**NOTE:** Unauthorized returns will not be accepted and will be returned at the shipper's expense.

**NOTE:** A returned product found upon inspection by AMETEK, to be in specification is subject to an evaluation fee and applicable freight charges.

This page intentionally left blank.

## ABOUT THIS MANUAL

---

This manual has been written expressly for the Sorensen DCS-E 3kW Series of power supplies, which have been designed and certified to meet the Low Voltage and Electromagnetic Compatibility Directive Requirements of the European Community. Units that comply with the directive are designated by an 'E' after the model designator (e.g., DCS 60-50E indicates that the model is certified) when configured for 230 VAC input only.

Since the goal of the Low Voltage Directive is to ensure the safety of the equipment operator, universal graphic symbols have been used both on the unit itself and in this manual to warn the operator of potentially hazardous situations (see Safety Symbols on page ii).

This manual is designed for the user who is familiar with basic electrical laws especially as they apply to the operation of power supplies. This implies recognition of Constant Voltage and Constant Current operating modes and the control of input and output power, as well as the observance of safety techniques while effecting supply or pin connections and any changes in switch and jumper settings. The more knowledgeable user will find that the detailed schematics and circuit descriptions available on our website, [www.programmablepower.com](http://www.programmablepower.com) will enable greater flexibility in troubleshooting and in configuring new applications.

**Section 1 Introducing the DCS-E Series 3kW Supply** describes the power supply, lists its features, and provides specifications .

**Section 2 Installation** reviews safety and inspection procedures, then goes through the basic set up procedures. Directions for the assembling of the AC input connector, for the testing of basic functions, and for connecting the load are also included.

**Section 3 Basic Operation** provides procedures for local programming mode operation (Constant Voltage and Constant Current) and remote sensing.

**Section 4 Advanced Operation** covers remote programming mode operation as well as procedures for using advanced programming features such as Over Voltage Protection (OVP), Output Power ON/OFF, and Remote Monitoring. This section also provides procedures for using multiple supplies in series, in parallel, and in split supply configurations.

**Section 5 Theory of Operation** provides a block diagram of the power supply, an explanation of the functions within each block, and more detailed descriptions of the circuitry.

**Section 6 Maintenance** covers service, calibration and repairs, and includes parts lists.

**Section 7 Application Notes** is reserved for additional system information.

This page intentionally left blank.

# CONTENTS

SECTION 1 INTRODUCING THE DCS-E SERIES 3KW SUPPLY....	1-1
1.1 Description.....	1-1
1.2 Features.....	1-1
1.3 Specifications.....	1-2
1.3.1 Electrical Specifications <sup>1</sup> .....	1-2
1.3.2 Mechanical Specifications.....	1-3
SECTION 2 INSTALLATION .....	2-1
2.1 Introduction.....	2-1
2.2 Safety 2-1	
2.2.1 High Energy/High Voltage Warning .....	2-1
2.2.2 AC Source Grounding.....	2-2
2.2.3 Operating and Servicing Precautions .....	2-2
2.2.4 Parts and Modifications.....	2-2
2.3 Initial Inspection.....	2-3
2.3.1 Physical Check .....	2-3
2.4 Location, Mounting, and Ventilation.....	2-3
2.4.1 Unit Dimensions.....	2-3
2.4.2 Rack Mounting .....	2-4
2.5 AC Input Power.....	2-4
2.5.1 AC Input Power Connection.....	2-4
2.5.2 AC Input Power Requirements .....	2-4

---

2.5.3	AC Input Connector Assembly .....	2-5
2.5.4	Strain Relief Assembly .....	2-6
2.6	Initial Functional Tests .....	2-8
2.6.1	Power-on Check.....	2-8
2.6.2	Voltage Mode Operation Check .....	2-8
2.6.3	Current Mode Operation Check .....	2-9
2.6.4	Front Panel Function Checks .....	2-9
2.7	Load Connection.....	2-10
2.7.1	Load Wiring .....	2-10
2.7.2	Making the Connections.....	2-11
2.7.3	Connecting Single Loads .....	2-12
2.7.4	Connecting Multiple Loads .....	2-12
 <b>SECTION 3 BASIC OPERATION .....</b>		<b>3-1</b>
3.1	Introduction .....	3-1
3.2	Standard Operation.....	3-1
3.2.1	Operating Modes and Automatic Crossover .....	3-1
3.2.2	Local Programming Mode Operation .....	3-3
3.3	Using Remote Sensing .....	3-4
3.3.1	Connecting Remote Sense Lines.....	3-4
 <b>SECTION 4 ADVANCED OPERATION .....</b>		<b>4-1</b>
4.1	Introduction .....	4-1
4.2	Configuring for Remote Programming, Sensing, and Monitoring.....	4-2
4.2.1	Programming, Monitoring, and Control Functions.....	4-2
4.2.2	Locating Jumpers, Switch, and Connector.....	4-4
4.2.3	Resetting Jumpers and Switch.....	4-5
4.2.4	Making J3 Connections .....	4-6
4.3	Remote Programming: Output Voltage and Current Limit.....	4-7

4.3.1	Programming Output Voltage and Current Limit with the REM/LOC Switch 4-8	
4.3.2	Programming Output Voltage .....	4-9
4.3.3	Programming Output Current Limit .....	4-12
4.4	Using Over Voltage Protection (OVP) .....	4-14
4.4.1	Front Panel OVP Operation .....	4-14
4.4.2	Resetting the OVP Circuit .....	4-14
4.4.3	Programming OVP with an External Voltage Source.....	4-15
4.5	Using the Shutdown Function.....	4-16
4.5.1	STANDBY Switch .....	4-16
4.5.2	Programming the Shutdown Function.....	4-16
4.5.3	Shutdown Application - Contact Closure .....	4-19
4.6	Remote Monitoring of Readback Signals and Status Indicators.....	4-21
4.6.1	Readback Signals .....	4-21
4.6.2	Status Indicators .....	4-21
4.7	Using Multiple Supplies .....	4-22
4.7.1	Configuring Multiple Supplies for Series Operation .....	4-22
4.7.2	Configuring Multiple Supplies for Parallel Operation .....	4-23
4.7.3	Configuring Multiple Supplies for Split Supply Operation .....	4-24
4.8	Output Voltage Biasing .....	4-25

## SECTION 5 THEORY OF OPERATION ..... 5-1

5.1	Introduction.....	5-1
5.2	Basic Functional Blocks.....	5-1
5.2.1	AC Input and RFI Filter (A5 PCB) .....	5-2
5.2.2	AC Input Rectifier and Inrush Limiting Circuit (A6 PCB) .....	5-2
5.2.3	PWM, Sync and Power Transformer Drive Circuit (A3 PCB).....	5-2
5.2.4	Power Transformer, Output Rectifiers, Output Filter Inductor and Capacitors, and Local Sense Connections (Power Stage, A7 PCB and A8 PCB) .....	5-2

5.2.5	Output Current Shunt, Shunt Amplifier, and Down Programmer (A4 PCB) 5-2	
5.2.6	Control, Programming, OVP, Shutdown, Monitoring, and Auxiliary Supply Circuits (A2 PCB) .....	5-3
5.2.7	Front Panel Displays and Local Operating Mode Controls (A1 PCB) ..	5-4
5.3	Detailed Circuit Descriptions .....	5-4
5.3.1	AC Input and RFI Filter Circuit (A5 PCB) .....	5-5
5.3.2	Input Rectifier and Inrush Limiting Circuit (A6 PCB) .....	5-5
5.3.3	PWM, Sync Circuit, Power Transformer Drive Circuit, and Power Transistor Bridge (A3 PCB).....	5-5
5.3.4	Power Transformer, Output Rectifiers, Output Filter Inductor and Capacitor, and Down Programmer Circuit (A4 PCB, A7 PCB, A8 PCB, and Power Stage Assembly) .....	5-6
5.3.5	Auxiliary Supply, OVP, Control, Programming, Monitor Circuit (A2 PCB)	5-7
5.3.6	Front Panel Displays and Controls (A1 PCB).....	5-14
<b>SECTION 6 MAINTENANCE.....</b>		<b>6-1</b>
6.1	Introduction .....	6-1
6.1.1	Units Under Warranty .....	6-1
6.2	General Service and Repair .....	6-1
6.2.1	Periodic Maintenance .....	6-1
6.2.2	Servicing Precautions.....	6-2
6.2.3	Parts Replacement and Repairs .....	6-2
6.2.4	Unusual or Erratic Operation.....	6-2
6.3	Calibrating for Programming Accuracy .....	6-2
6.3.1	Voltage Programming Circuit Calibration .....	6-3
6.3.2	Current Programming Circuit Calibration .....	6-3
6.4	Replaceable Parts.....	6-4
6.4.1	Parts Replacement and Modifications.....	6-4
6.4.2	Ordering Parts .....	6-4
6.4.3	DCS-E 3kW Parts Lists by Model Number .....	6-5



SECTION 7 APPLICATION NOTES .....	7-1
7.1 Battery Charging.....	7-1
7.2 Load Considerations.....	7-1
7.2.1 Inductive Loads.....	7-1

## LIST OF FIGURES

Figure 1-1 DCS-E Series (3kW) Supply Front Panel Controls and Indicators.....	1-4
Figure 1-2 DCS-E Series (3kW) Supply Rear Panel Connectors and Terminals (including optional internal GPIB Interface) .....	1-5
Figure 2-1 AC Connector and Contacts .....	2-5
Figure 2-2 Wire Preparation .....	2-5
Figure 2-3 Contact Orientation .....	2-6
Figure 2-4 AC Wire Locations .....	2-6
Figure 2-5 Strain Relief, as Supplied.....	2-7
Figure 2-6 Strain Relief Assembly .....	2-7
Figure 2-7 Connector J3 Default Configuration .....	2-8
Figure 2-8 Maximum Load Wire Length .....	2-11
Figure 2-9 Single Load with Local Sensing (Default) .....	2-12
Figure 2-10 Single Load with Remote Sensing .....	2-12
Figure 2-11 Multiple Loads with Local Sensing.....	2-13
Figure 2-12 Multiple Loads with Remote Sensing.....	2-13
Figure 3-1 Operating Modes.....	3-2
Figure 3-2 Local Mode Default Configuration.....	3-3
Figure 3-3 Connecting Remote Sense Lines.....	3-5
Figure 4-1 Connector J3 Pin Descriptions (for Remote Programming, Remote Monitoring, and Sense Connections) .....	4-3
Figure 4-2 Internal Jumpers and Switch (Default Settings Shown) .....	4-4
Figure 4-3 Programming Output Voltage and Current Limit Using the REM/LOC Switch.....	4-8
Figure 4-4 Programming Output Voltage with a 0-5 Vdc Source .....	4-9

Figure 4-5	Programming Output Voltage with a 0-10 Vdc Source .....	4-10
Figure 4-6	Programming Output Voltage with a 0-1 mA Source.....	4-10
Figure 4-7	Programming Output Voltage with a 5k ohm Resistance .....	4-11
Figure 4-8	Programming Output Current Limit with a 0-5 Vdc Source .....	4-12
Figure 4-9	Programming Output Current Limit with a 0-10 Vdc Source .....	4-12
Figure 4-10	Programming Output Current Limit with a 0-1 mA Source .....	4-13
Figure 4-11	Programming Output Current Limit with a 5k ohm Resistance.....	4-13
Figure 4-12	Remote Programming of OVP with a 0-5 Vdc External Voltage Source .....	4-15
Figure 4-13	Remote Programming of OVP with a 0 –10 Vdc External Voltage Source .....	4-16
Figure 4-14	Using Shutdown with a TTL Compatible (Positive Logic).....	4-17
Figure 4-15	Using Shutdown with a TTL Compatible (Negative Logic) .....	4-17
Figure 4-16	Using Shutdown with an AC or DC Input (Positive Logic) .....	4-18
Figure 4-17	Using Shutdown with an AC or DC Input (Negative Logic) .....	4-18
Figure 4-18	Using Shutdown with Contact Closure of a Normally OPEN Relay (Positive Logic).....	4-19
Figure 4-19	Using Shutdown with Contact Closure of a Normally OPEN Relay (Negative Logic) .....	4-20
Figure 4-20	Using Shutdown with Contact Closure of a Normally CLOSED Relay (Positive Logic) .....	4-20
Figure 4-21	Using Shutdown with Contact Closure of a Normally CLOSED Relay (Negative Logic) .....	4-20
Figure 4-22	Series Operation of Multiple Supplies .....	4-22
Figure 4-23	Parallel Operation of Multiple Supplies.....	4-23
Figure 4-24	Split Supply Operation of Multiple Supplies (Two Positive Voltages) .....	4-24
Figure 4-25	Split Supply Operation of Multiple Supplies (Positive-Negative Supply) .....	4-25

# SECTION 1

## INTRODUCING THE DCS-E SERIES 3KW SUPPLY

### 1.1 DESCRIPTION

The DCS-E Series System Supplies are 3000-watt supplies designed to provide highly stable, continuously variable output voltage and current for a broad range of development, system, and burn-in applications. The DCS-E Series employs high frequency switching regulator technology to achieve high power density and small package size.

The series consists of several models designated by the DCS prefix, followed by their output voltage and current ratings. For example, the model number DCS 60-50E indicates that the unit is rated at 0-60 Vdc and 0-50 Amps.

### 1.2 FEATURES

- Eight models with voltage ranges from 0-8 Vdc to 0-150 Vdc and current outputs from 20A to 350A.
- Input voltage 190-250 Vac, Three Phase, 47-63 Hz or 200-250 Vac, Single Phase, 47-63 Hz. (Output power limited to 2500W for single-phase input.)
- Simultaneous digital display of both DC output voltage and current.
- Ten-turn potentiometer voltage and current controls permit high resolution setting of the output voltage and current from zero to the model-rated output.
- Front panel push button control of Output Standby Mode, OVP reset, Remote/Local Programming Mode selection, and preview of voltage, current, or OVP setpoints.
- External indicator signals for Remote Monitoring of OVP Status, Local/Remote Programming Status, Thermal Shutdown, and Output Voltage and Current.
- Current or Voltage Mode operation with Automatic Mode Crossover to respond to varying load requirements.
- Flexible output configuration where multiple units can be connected in series or in parallel to provide increased voltage or increased current.
- Remote Sensing to compensate for losses in power leads up to 1V per lead.
- Adjustable Over Voltage Protection (OVP).

- External Shutdown using AC, DC, or TTL compatible signals (positive or negative logic).
- Remote Voltage, Current Limit, and OVP Programming with selectable programming ranges.
- Optional IEEE-488 (GPIB) interface for complete digital remote programming and readback capability.

## 1.3 SPECIFICATIONS

### 1.3.1 Electrical Specifications<sup>1</sup>

Models	DCS 8-350E	DCS 12-250E	DCS 20-150E	DCS 40-75E	DCS 55-55E	DCS 60-50E	DCS 80-37E	DCS 150-20E
Output Ratings								
Output Voltage	0-8V	0-12V	0-20V	0-40V	0-55V	0-60V	0-80V	0-150V
Output Current	0-350A	0-250A	0-150A	0-75A	0-55A	0-50A	0-37A	0-20A
Output Power	2800W	3000W	3000W	3000W	3025W	3000W	2960W	3000W
Line Regulation <sup>2</sup>								
Voltage	8 mV	12 mV	20 mV	40 mV	55 mV	60 mV	80 mV	150 mV
Current	350 mA	250 mA	150 mA	75 mA	55 mA	50 mA	37 mA	20 mA
Load Regulation <sup>3</sup>								
Voltage	8 mV	12 mV	20 mV	40 mV	55 mV	60 mV	80 mV	150 mV
Current	350 mA	250 mA	150 mA	75 mA	55 mA	50 mA	37 mA	20 mA
Meter Accuracy								
Voltage	0.09V	0.13V	0.2V	0.5V	0.65V	0.7V	0.9V	1.6V
Current	4.5A	3.5A	0.1.6A	0.85A	0.65A	0.6A	0.47A	0.30A
OVP Adjustment Range	0.4-8.8V	0.6-13.2V	1-22V	2-44V	2.75-60.5V	3-66V	4-88V	7.5-165V
Output Noise and Ripple (V)								
Rms	10 mV	10 mV	10 mV	20 mV	20 mV	20 mV	20 mV	30 mV
p-p (20 Hz – 20 MHz)	100 mV	100 mV	100 mV	100 mV	100 mV	100 mV	100 mV	200 mV
Analog Programming Linearity								
Voltage	80 mV	120 mV	200 mV	400 mV	550 mV	600 mV	800 mV	1.5V
Current	3500 mA	2500 mA	1500 mA	750 mA	550 mA	500 mA	370 mA	200 mA

<sup>1</sup> Specifications are warranted over a temperature range of 0–50°C with default local sensing. From 50–70°C, derate 2% per °C.

<sup>2</sup> For input voltage variation over the AC input voltage range, with constant rated load.

<sup>3</sup> For 0-100% load variation, with constant nominal line voltage.

**AC Input:** 200-250 Vac at 20 Arms Single Phase or 190-250 Vac at 14 Arms Three Phase  
(Output power limited to 2500W for single phase input)

**Maximum Voltage Differential from output to safety ground:** 150 Vdc

**ADDITIONAL CHARACTERISTICS**

<b>Models</b>	DCS8-350E	DCS12-250E	DCS20-150E	DCS40-75E	DCS55-55E	DCS60-50E	DCS80-37E	DCS150-20E
<b>Stability<sup>4</sup></b>								
Voltage	4 mV	6 mV	10 mV	20 mV	27.5 mV	30 mV	40 mV	75 mV
Current	175 mA	125 mA	75 mA	37.5 mA	27.5 mA	25 mA	18.5 mA	10 mA
<b>Temperature Coefficient<sup>5</sup></b>								
Voltage	1.6 mV/°C	2.4 mV/°C	4 mV/°C	8 mV/°C	11 mV/°C	12 mV/°C	16 mV/°C	30 mV/°C
Current	105 mA/°C	75 mA/°C	45 mA/°C	22.5 mA/°C	16.5 mA/°C	15 mA/°C	11.1 mA/°C	6.0 mA/°C
<b>Maximum Remote Sense Line Drop Compensation</b>	1V/line	1V/line	1V/line	1V/line	1V/line	1V/line	1V/line	1V/line

<sup>4</sup> Maximum drift over 8 hours with constant line, load, and temperature, after 90-minute warmup.

<sup>5</sup> Change in input per °C change in ambient temperature with constant and load.

**Operating Ambient Temperature:**

0 - 50°C No derating. From 50 - 70°C, derate output 2% per °C

**Storage Temperature Range:** -55 to +85°C**Humidity Range:** 0 - 80 % Non-condensing**Time Delay from power on until output stable:** 5 seconds maximum**Switching Frequency:** Nominal 30 kHz (60 kHz output ripple)**Voltage Mode Transient Response Time:**

1 mS recovery to 1% band for 30% step load change from 70% to 100% or 100% to 70%

**Remote Start/Stop and Interlock:**

TTL Compatible Input, Contact Closure, 12 – 250 Vac or 12 – 130 Vdc

**Remote Analog Programming (Full Scale Input)**

<b>Parameter</b>	<b>Resistance</b>	<b>Voltage</b>	<b>Current</b>
Voltage	0 - 5k	0 - 5V, 0 - 10V	0 - 1 mA
Current	0 - 5k	0 - 5V, 0 - 10V	0 - 1 mA
OVP	—	0 - 5V, 0 - 10V	—

**1.3.2 Mechanical Specifications**

**Size:** 87.6 mm H x 482.6 mm W x 508 mm D (3.45 in H x 19 in W x 20 in D)

**Weight:** 16 kg (35 lbs) (approx.)

**Output Connector:**

Nickel-plated copper bus bars: 2.25" x 1.0" x 0.125" (2.25" x 1.0" x 0.25" for 8V & 12V models)

Bus bar load wiring mounting holes:

One 0.332" diameter hole; 1/4" hardware (5/16" hardware for 8V and 12V models)

Two 0.190" diameter holes on 0.5" centers; #10 hardware

**Input Connector:**

Chassis-Mounted Part: Housing Tyco 641685-1; Contact pins Tyco 350821-1

Mating Connector Parts: Housing Tyco 643267-1; Contact pins Tyco 350821-1

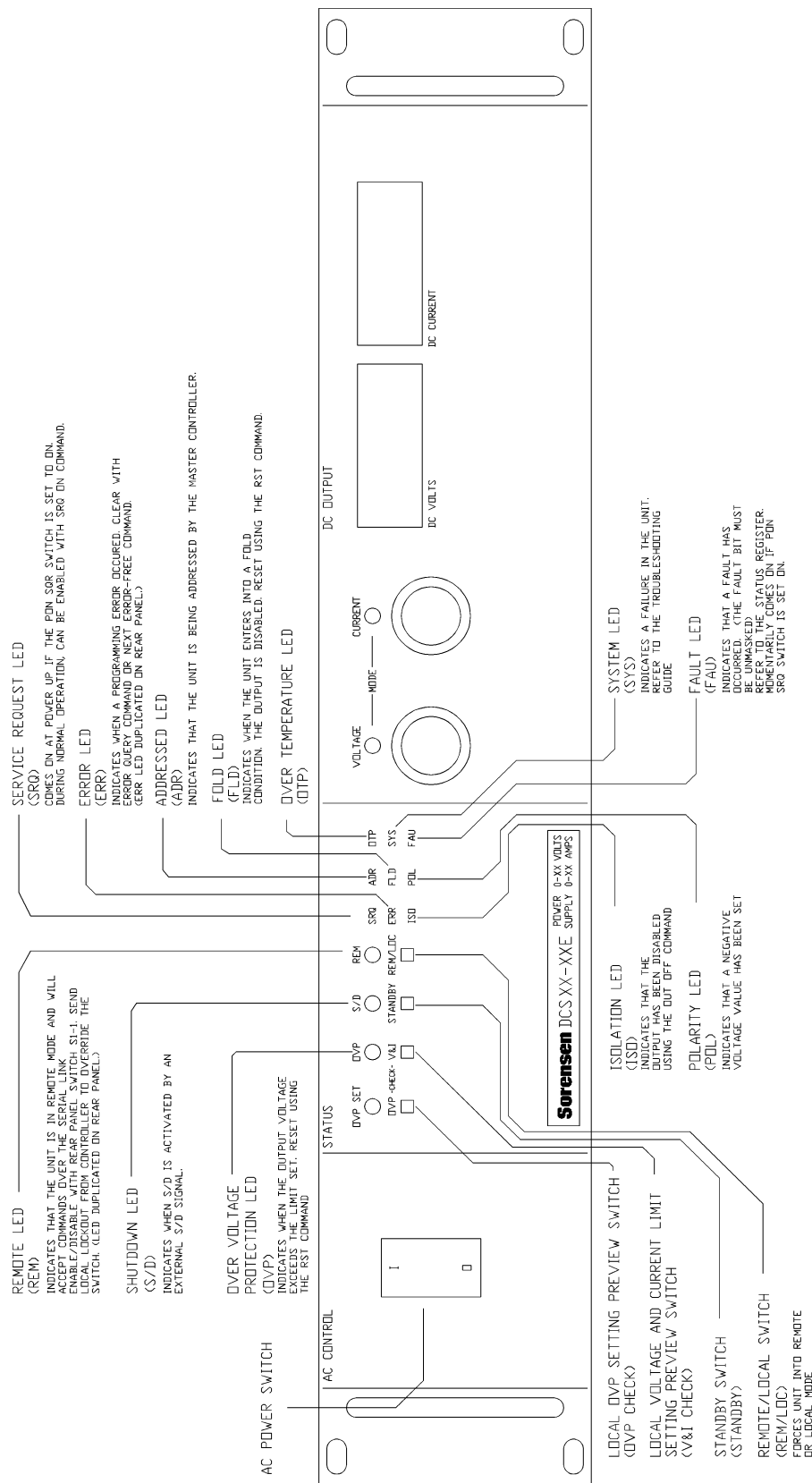

Figure 1-1 DCS-E Series (3kW) Supply Front Panel Controls and Indicators

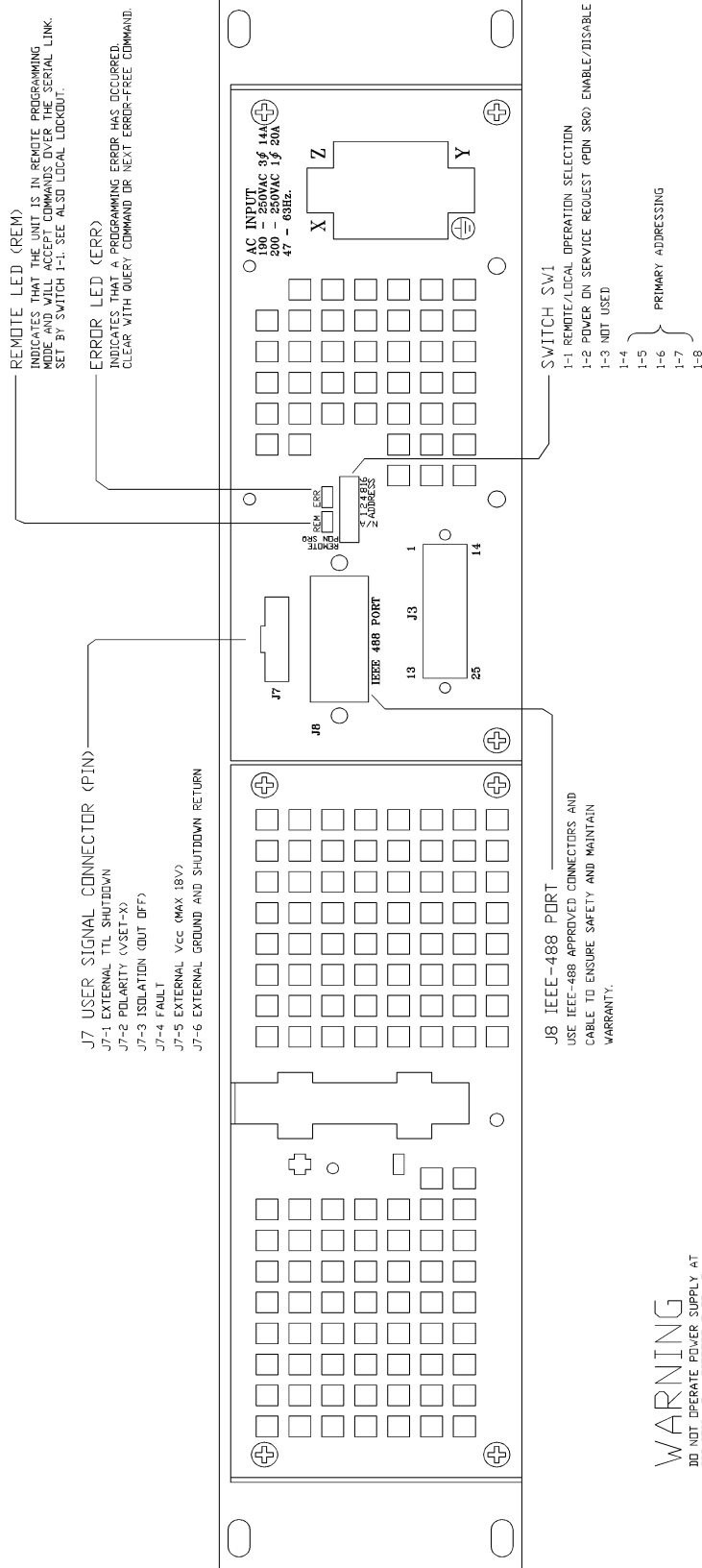

Figure 1-2 DCS-E Series (3kW) Supply Rear Panel Connectors and Terminals (including optional internal GPIB Interface)

This page intentionally left blank.



# SECTION 2 INSTALLATION

## 2.1 INTRODUCTION

This section provides recommendations and procedures for inspecting, testing, and installing the DCS-E Series power supply.

1. Read and follow the safety recommendations (**Section 2.2**)
2. Perform an initial physical inspection of the supply (**Section 2.3**)
3. Install the supply (bench or rack mount), ensuring adequate ventilation (**Section 2.4**)
4. Assemble and connect the AC input power connector (**Section 2.5.1**)
5. Perform initial function tests for voltage mode operation, current mode operation, and front panel controls (**Section 2.6**)
6. Connect the load (**Section 2.7**)

Instructions for Local Programming Mode operation (Constant Voltage and Constant Current) are given in **Section 3 Basic Operation**. Remote Programming operation, monitoring, and programmable functions are described in **Section 4 Advanced Operation**.

## 2.2 SAFETY

Please review the following points for both personal and equipment safety while using the DCS-E Series power supplies.

### 2.2.1 High Energy/High Voltage Warning



Exercise caution when using and servicing power supplies. High energy levels can be stored at the output voltage terminals on all power supplies in normal operation. In addition, potentially lethal voltages exist in the power circuit and the output connector of power supplies that are rated at 40V and over. Filter capacitors store potentially dangerous energy for some time after power is removed.

Use extreme caution when biasing the output relative to the chassis due to potential high voltage levels at the output terminals. The output of the DCS-E Series supplies (3kW models) may be biased up to a maximum of 150 Vdc relative to the chassis.

### 2.2.2 AC Source Grounding

Ensure the power supply is connected to an appropriately rated AC outlet with the recommended AC input connector as set out in **Section 2.5.1 AC Input Power Connection**. There is a shock hazard if the power supply chassis and cover are not connected to an electrical ground via the safety ground in the AC input connector. The third wire in a single phase AC input connector and the fourth wire in a three phase AC input connector must be connected to an electrical ground at the power outlet. Any disconnection of this ground will cause a potential shock hazard to operating personnel.

This power supply is equipped with an AC line filter to reduce electromagnetic interference and must be connected to a properly grounded receptacle, or a shock hazard will exist.

Operating the supply at line voltages or frequencies in excess of those specified may cause leakage currents in excess of 5.0 mA peak from the AC line to the chassis ground.

### 2.2.3 Operating and Servicing Precautions

Exceeding the maximum model-rated input voltage may cause permanent damage to the unit.

Always disconnect power, discharge circuits, and remove external voltage sources before making internal adjustments or replacing components. When performing internal adjustments or servicing the power supply, ensure another person with first aid and resuscitation certification is present. Repairs must be made by experienced technical personnel only.

Be sure to isolate the power supply from the input line with an isolation transformer when using grounded test equipment, such as an oscilloscope, in the power circuit.

The power supply must not be operated where flammable gases or fumes exist.

### 2.2.4 Parts and Modifications

Do not use substitute parts or make unauthorized modifications to the power supply to ensure that its safety features are not degraded. Contact the manufacturer for service and repair help.

## 2.3 INITIAL INSPECTION

On first receiving your DCS-E Series power supply, perform a quick physical check, paying particular attention to front panel controls and indicators as well as rear panel connectors and terminals. See **Figure 1-1** and **Figure 1-2** for front and rear panel diagrams.

### 2.3.1 Physical Check

After unpacking, perform an initial inspection to ensure the unit and parts shipped with it have not been damaged in transit. The package should contain the power supply, a manual, one (1) AC input connector, and five (5) contact pins.

1. Inspect for dents and scratches to the cover and chassis; for scratches and cracks on the front and rear panels; and for any broken controls, connectors, or displays.
2. Turn front panel controls from stop to stop. Rotation should be smooth.
3. Test the action of the power switch. Switching action should be positive.
4. If internal damage is suspected, remove the cover and check for printed circuit board and/or component damage. Reinstall cover.

If damage is found to have occurred, save all packing materials and notify the carrier immediately. Refer to the terms of the warranty. Direct repair problems to the manufacturer.

**Note:** **Section 2.6 Initial Functional Tests** contains electrical and operational tests you can perform to ensure the unit is in proper working order after shipment. The tests are to be performed once the AC input connector has been assembled but before the load has been connected to the power supply.

## 2.4 LOCATION, MOUNTING, AND VENTILATION

The DCS-E system supply may be used in rack mounted or in benchtop applications. In either case, you must allow at least 1U (1.75") clearance for cooling air to reach the ventilation inlets on the top of each unit. You must also allow sufficient space for unobstructed airflow on each side and rear of all units so that the operating ambient temperature is within specification (see Section 1.3, *Specifications*, in this manual).



**CAUTION!**

**Obstructing the air inlets and/or exhaust may cause fire and irreversible damage to the unit.**

### 2.4.1 Unit Dimensions

Single Unit	Height	Width	Depth	Weight
Standard	3.45 in	19 in	20 in	35 lbs
Metric	87.6 mm	482.6 mm	508 mm	16 kg

## 2.4.2 Rack Mounting

The supply is designed to fit in a standard 19" equipment rack. Bolt holes in the chassis sides are provided for rack mount slides such as the ZERO #C300S18 slides. When installing the unit in a rack, be sure to provide adequate support for the rear of the unit while not obstructing the ventilation on the top, sides and rear of all units. (See Section 2.4, *Location, Mounting, and Ventilation* in this manual).



**CAUTION!**

**Rack mounting bolts must not extend more than 3/16" into the side of the power supply.**

## 2.5 AC INPUT POWER

**Section 2.5.1 AC Input Power Connection** gives instructions for making connections to either single phase or three phase AC power sources. Order replacement AC input connectors and contacts using the following part numbers.

<b>Chassis-Mounted Parts</b>	Housing	Tyco 641685-1
	Contact Pins	Tyco 350821-1
<b>Mating Connector Parts</b>	Connector Housing	Tyco 643267-1
	Contact Pins	Tyco 350821-1

### 2.5.1 AC Input Power Connection

Before you can use the DCS-E system supply, you must determine your AC input power requirements and assemble an appropriate line cord and connector. The power supply is shipped with a kit of connector and strain relief parts which you assemble using the procedures in this section.

### 2.5.2 AC Input Power Requirements

This supply may be operated from either a single phase or a three phase AC power source. The specifications for input voltage, current, and frequency are listed below.

<b>AC Input Voltage Range</b>	<b>Maximum Input Current</b>	<b>Frequency</b>
200-250 Vac Single Phase	20 Arms	47-63 Hz
190-250 Vac Three Phase	14 Arms	47-63 Hz



**CAUTION!**

**The maximum output power must be limited to 2500 Watts when the power supply is used with a single phase input to avoid tripping the power supply's input circuit breaker.**

### 2.5.3 AC Input Connector Assembly

Each unit is shipped with a connector and contacts which mate with the chassis-mounted AC connector located on the rear panel. See **Figure 2-1 AC Connector and Contacts**.

#### PARTS SUPPLIED

- One (1) connector Part number MI-6432-672, Tyco 643267-1
- Five (5) contacts Part number MC-3508-211, Tyco 350821-1

#### ADDITIONAL PARTS REQUIRED

- 8 to 12 AWG wiring: three (3) wires for single phase inputs or four (4) wires for three phase inputs. The neutral CONNECTOR wire of three-phase four (4) wire systems is not required.

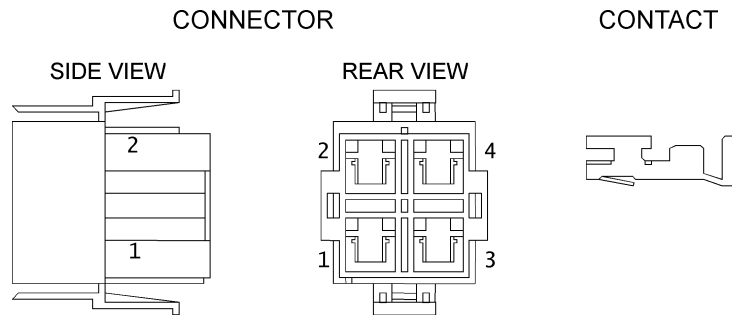

**Figure 2-1 AC Connector and Contacts**

#### WIRE PREPARATION

1. Trim outer wire jacket 2". (Necessary for strain relief. See **Section 2.5.4.**)
2. Strip 0.300" at the end of the insulated AC input wire.
3. Crimp the stripped wire into the contact as indicated in **Figure 2-2**, then solder the connection.
4. Crimp the contact around the wire insulation as indicated in **Figure 2-2**.

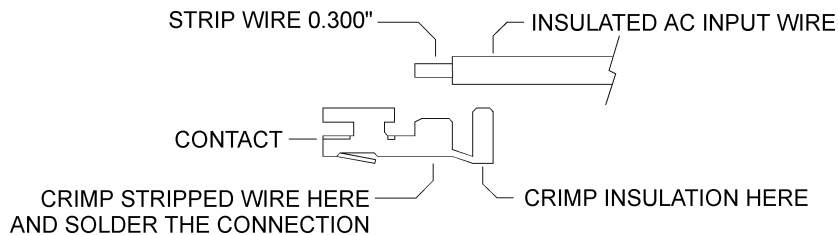

**Figure 2-2 Wire Preparation**

**CONTACT INSTALLATION**

5. Insert contact with attached wire into the connector until lock snaps into place. See **Figure 2-3** and **Figure 2-4** to complete the connector for either single or three phase input.

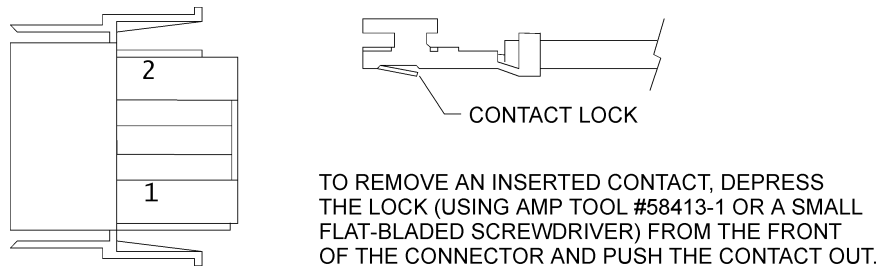
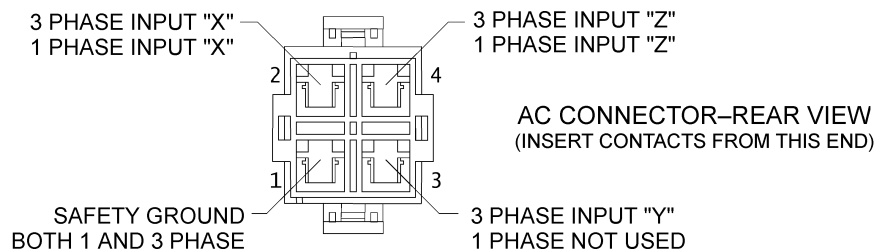
**Figure 2-3 Contact Orientation****Figure 2-4 AC Wire Locations****2.5.4 Strain Relief Assembly**

The strain relief is assembled from supplied pieces and attaches to the AC input connector to provide support for the AC input cord.

**PARTS SUPPLIED**

- Two (2) pieces strain relief Part number MI-6432-661, Tyco 643266-1
- Two (2) screws Part number MS-6PPS-10 (screw #6-32, 5/8" long, self tapping)

**ASSEMBLY INSTRUCTIONS**

1. Snap off the rectangular bushing attached to each piece of the strain relief. See **Figure 2-5**.
2. Install bushings on strain relief pieces, if required:  
If cable diameter is within 0.1" to 0.4", install bushings.  
If cable diameter is within 0.5" to 0.74", do not use bushings.

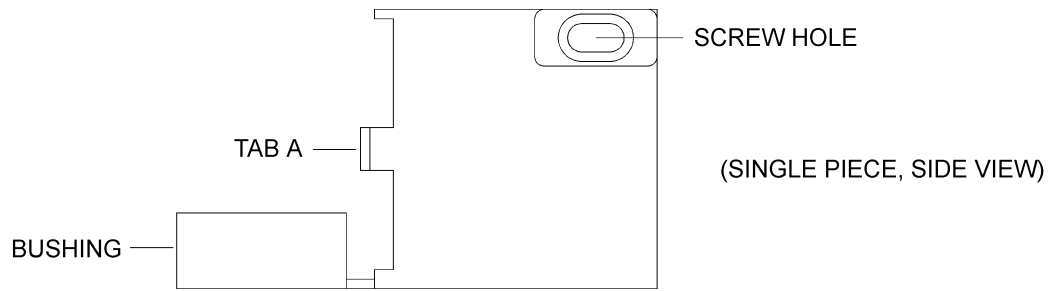

**Figure 2-5 Strain Relief, as Supplied**

3. Insert strain relief tab A into AC input connector slot B. Insert second strain relief tab A into AC input connector slot C. See **Figure 2-6**.
4. Install screws in holes provided on outside of strain relief pieces. Thread through to screw standoff inside opposite piece. Tighten to clamp outer jacket of AC wire securely, ensuring that the side of the strain relief slips into the corresponding rabbet on the opposite piece.

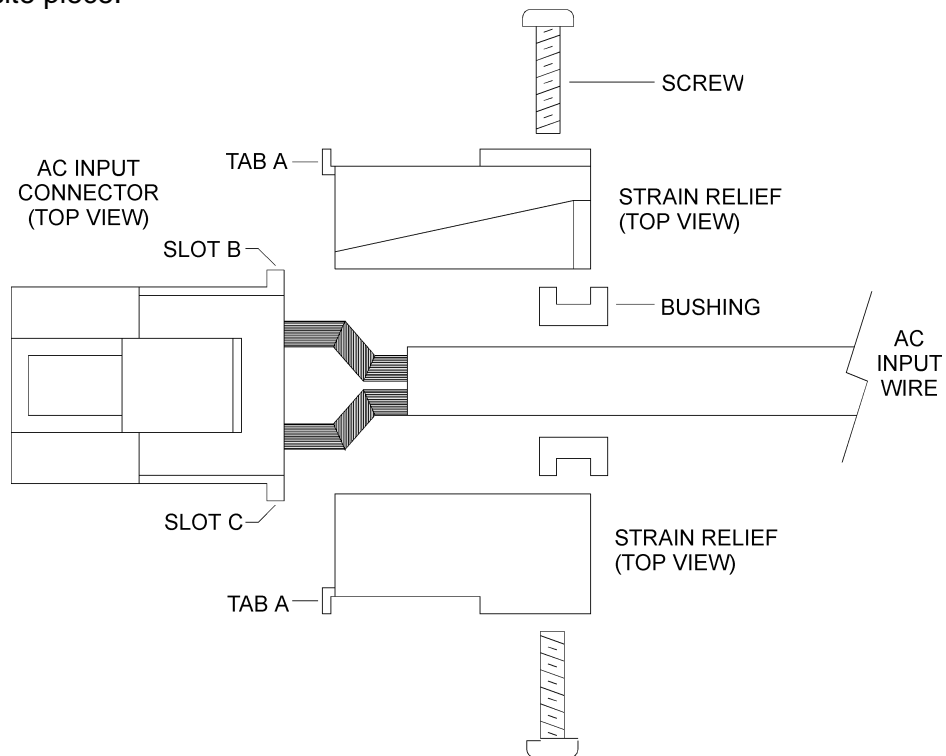
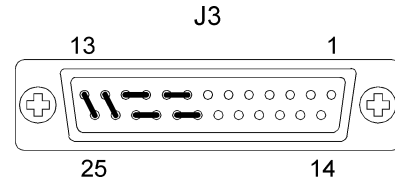

**Figure 2-6 Strain Relief Assembly**

## 2.6 INITIAL FUNCTIONAL TESTS

The initial functional test procedure includes power-on and front panel function checks as well as voltage or current mode operation checks. See **Figure 1-1** and **Figure 1-2** for front and rear panel diagrams.

Before starting this procedure, ensure that the J3 programming connector is in place on the rear panel with jumpers connected for local operation as shown in **Figure 2-7**. This is the default configuration as shipped from the factory. If the unit has been in use and is being retested, ensure you disconnect the load, reset the J3 jumpers to the default, and turn the OVP potentiometer to maximum before performing these tests.



**Figure 2-7 Connector J3  
Default Configuration**

### 2.6.1 Power-on Check

1. Ensure that the AC power switch is in the OFF position.  
Note: AC power must be off for a minimum of 45 seconds before powering on again.
2. Turn the voltage and current controls fully counter-clockwise.
3. Connect the unit to an AC outlet.
4. Turn the front panel AC power switch ON.

After a short, power-on delay, the front panel digital meters will light up. Both voltmeter and ammeter displays will read zero. The green voltage mode LED will be illuminated.

### 2.6.2 Voltage Mode Operation Check

1. Ensure the voltage and current controls on the front panel are turned fully counter-clockwise.
2. Connect a Digital Voltmeter (DVM) to the output terminals on the rear panel, observing correct polarity. The DVM must be rated better than 0.5% accuracy.
3. Turn the CURRENT control a 1/2-turn clockwise. Slowly turn the VOLTAGE control clockwise and observe both the front panel voltmeter and the DVM.
4. Compare the DVM reading with the front panel voltmeter reading to verify the accuracy of the internal voltmeter.

The minimum control range will be from zero to the maximum rated output for this particular power supply model. The green voltage mode LED will be illuminated.

5. Turn the front panel AC power switch OFF.



### 2.6.3 Current Mode Operation Check

1. Ensure the front panel AC power switch is set to OFF.
2. Turn the voltage and current controls on the front panel fully counter-clockwise.
3. Turn the VOLTAGE control one (1) or two (2) turns clockwise.
4. Connect a DC shunt across the output terminals on the rear panel, using appropriately gauged wire and hardware. The recommended current ratings for the DC shunt and the wire must be at least 10% more than the output current of the power supply model.
5. Connect a Digital Voltmeter (DVM) across the DC shunt. The DC shunt-DVM combination must be rated better than 0.5% accuracy.
6. Turn the AC power switch ON.
7. Turn the CURRENT control slowly clockwise.
8. Compare the DVM reading with the front panel ammeter reading using  $I=V/R$  where V is the DVM reading and R is the DC shunt resistance.

The control range will be from zero to the maximum rated output for the power supply model. The red current mode LED will be illuminated.

### 2.6.4 Front Panel Function Checks

1. Press OVP CHECK switch and check that the voltmeter displays approximately the model-rated output voltage plus 10%.
2. Turn OVP SET potentiometer counter-clockwise and check that the voltmeter reading decreases. Continued turning (up to 20 turns) will see the reading decrease to approximately 5% of the model-rated voltage output. Turn the potentiometer clockwise until the voltmeter once again displays approximately the model-rated output voltage plus 10%.
3. With voltage and current controls turned all the way in a clockwise direction, press the V & I CHECK switch and check that the voltmeter and ammeter display a minimum of the power supply model output ratings.
4. With voltage and current controls turned all the way in a clockwise direction, push the STANDBY switch to its IN position and check that the voltmeter reading falls to zero and the S/D (Shutdown) LED illuminates. Push the STANDBY switch once again to reset it to its OUT position. The S/D LED will turn off.
5. Push REM/LOC switch to IN position and check that the REM LED illuminates and the voltmeter reading falls to zero. Reset the REM/LOC switch to its OUT position for local (default) operation.

## 2.7 LOAD CONNECTION

This section provides recommendations for load wiring and connecting as they apply to both single and multiple load configurations.

### 2.7.1 Load Wiring

When connecting load wiring to the power supply, you must consider the following factors:

- the current carrying capacity of the wire,
- the maximum load wiring length for operation with sense lines, and
- noise and impedance effects of the load lines.

#### CURRENT CARRYING CAPACITY

As a minimum, load wiring must have a current capacity greater than the output current rating of the power supply. This ensures that the wiring will not be damaged even if the load is shorted.

The table below shows the maximum current rating, based on 450 amps per square centimeter, for various gauges of wire rated for 105°C operation. Operation at the maximum current rating results in approximately a 30-degree temperature rise for a wire operating in free air. Where load wiring must operate in areas with elevated ambient temperatures or bundled with other wiring, larger gauges or higher temperature-rated wiring should be used.

AWG	Maximum Current	AWG	Maximum Current
16	7	4	106
14	11	2	170
12	18	1	209
10	23	1/0	270
8	39	2/0	330
6	67	3/0	350

#### LOAD WIRING LENGTH FOR OPERATION WITH SENSE LINES

For applications using remote sensing, the voltage drop across each load line must be limited to 1V or less. **Figure 2-8** shows the maximum allowable wire length that may be used for a given load current and wire size to ensure that this limit is not exceeded.

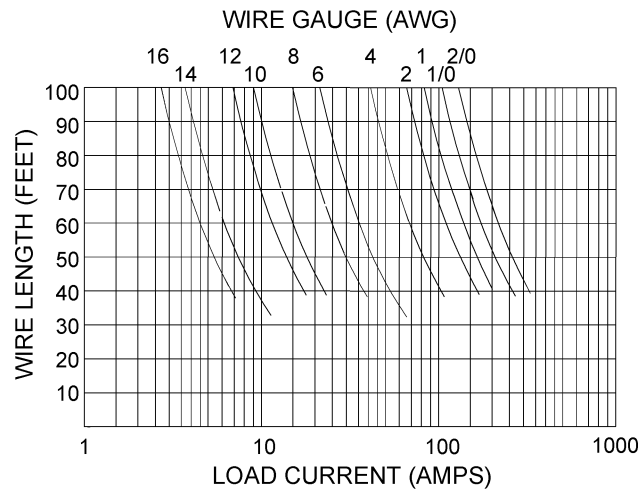

**Figure 2-8 Maximum Load Wire Length**

### NOISE AND IMPEDANCE EFFECTS

To minimize noise pickup or radiation, load wires should be shielded-twisted pair wiring of as short a length as possible. Connect the shield to the chassis via a rear panel mounting screw. Where shielding is impossible or impractical, simply twisting the wires together will offer some noise immunity. When using local sense connections, use the largest practical wire size to minimize the effects of load line impedance on the regulation of the supply.

#### 2.7.2 Making the Connections

Load connections to the power supply are made at the positive and negative output terminals (or bus bars) at the rear of the power supply. Refer to the rear panel diagram in **Figure 1-2**. The power supply provides three load wiring mounting holes on each bus bar terminal as specified in the following table.

Load Wiring Mounting Holes	Diameter	Hardware Size
One (1) per terminal	0.332"	1/4" (5/16" for 8V and 12V models)
Two (2) per terminal	0.190" on 0.5" centers	#10

When making connections to the bus bars, ensure each terminal's mounting hardware and wiring assembly is placed to avoid touching the other terminal (***or EMI core***) and shorting the power supply output. Heavy connecting cables must have some form of strain relief to avoid loosening the connections or bending the bus bars.

### 2.7.3 Connecting Single Loads

**Figure 2-9** and **Figure 2-10** show recommended load and sensing connections for single loads. Local sense lines shown are default J3 connections. Refer to **Section 3.3.1 Connecting Remote Sense Lines** for more information about the sense line shield.

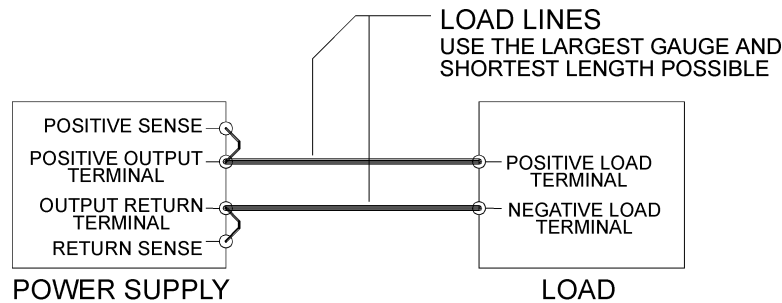

**Figure 2-9 Single Load with Local Sensing (Default)**

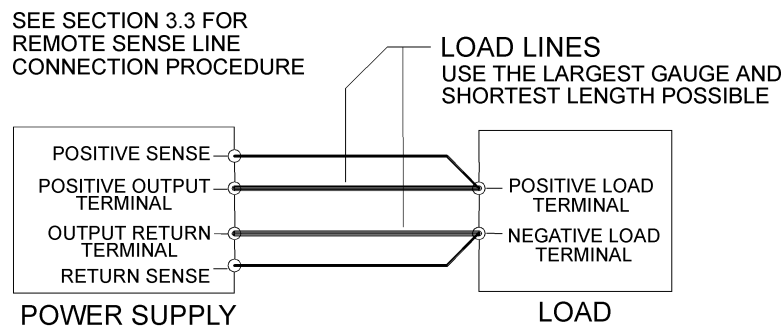

**Figure 2-10 Single Load with Remote Sensing**

### 2.7.4 Connecting Multiple Loads

Proper connection of distributed loads is an important aspect of power supply applications. Two common methods of connection are the parallel power distribution method and the radial distribution method.

#### PARALLEL POWER DISTRIBUTION

This common method involves connecting leads from the power supply to one load, from that load to the next load, and so on for each load in the system. This distribution method results in the voltage at each load depending on the current drawn by the other loads, allowing dc ground loops to develop. Except for low current applications, this method is not recommended.

## RADIAL DISTRIBUTION METHOD

With this method, power is connected to each load individually from a single pair of terminals designated as the positive and negative distribution terminals. These terminals may be the power supply output terminals, the terminals of one of the loads, or a distinct set of terminals especially established for distribution use. Connecting the sense leads to these terminals will compensate for losses and minimize the effect of one load upon another.

**Figure 2-11** and **Figure 2-12** show recommended load and sensing connections for multiple loads. Local sense lines shown are default J3 connections. Refer to **Section 3.3.1 Connecting Remote Sense Lines** for more information about grounding the sense line shield.

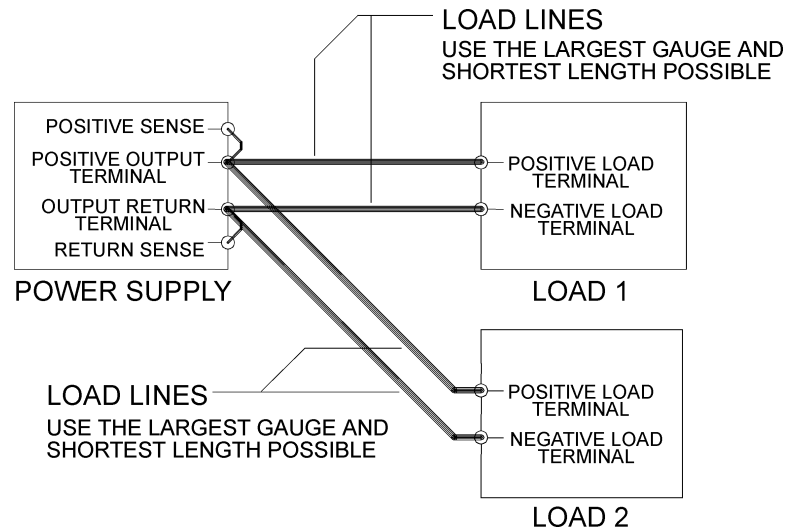

**Figure 2-11 Multiple Loads with Local Sensing**

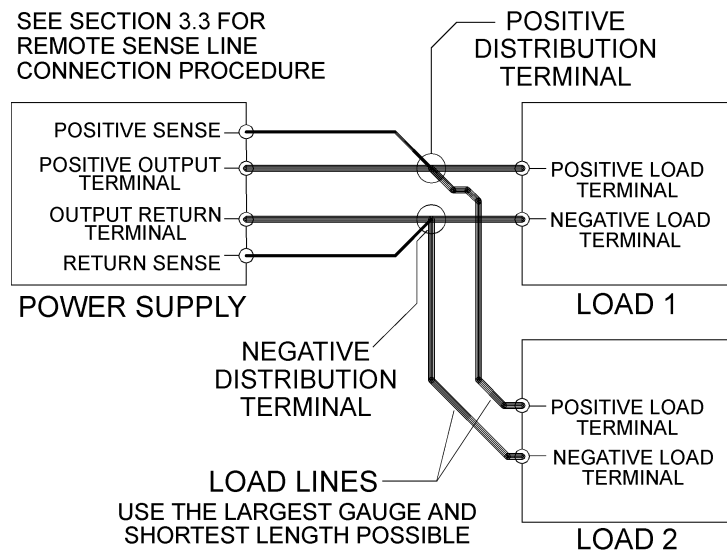

**Figure 2-12 Multiple Loads with Remote Sensing**

This page intentionally left blank.

# SECTION 3

## BASIC OPERATION

### 3.1 INTRODUCTION

Once the power supply installation is complete and both the AC input power and the load have been connected (see **Section 2 Installation**), the DCS-E Series power supply is in its default configuration and is ready to operate in local programming mode.

This section covers Constant Voltage and Constant Current Mode operation as controlled by local programming (**Section 3.2**). Remote sensing for voltage mode operation is described and illustrated in **Section 3.3**.

Remote Programming operation, monitoring, and programmable functions are described in **Section 4 Advanced Operation**.

### 3.2 STANDARD OPERATION

The DCS-E Series power supply has two basic **operating modes**: Constant Voltage Mode and Constant Current Mode, and two **control modes**: Local Programming Mode (default setting) and Remote Programming Mode. Both operating modes are available regardless of which control mode is used.

This section deals with power supply operations using the default Local Programming Mode in both Constant Voltage Mode and Constant Current Mode. Remote Programming Mode as well as monitoring and programmable functions information is found in **Section 4 Advanced Operation**. See also **Section 3.3** for remote sense operations.

#### 3.2.1 Operating Modes and Automatic Crossover

Whether controlled by local or remote programming, the power supply has two basic operating modes: Constant Voltage Mode and Constant Current Mode. The mode in which the power supply operates at any given time depends on the combination of:

- the output voltage setting  $V_{SET}$ ,
- the output current limit setting  $I_{SET}$ , and
- the resistance of the attached load  $R_L$ .

**Figure 3-1** provides a graphical representation of the relationships between these variables.

### CONSTANT VOLTAGE MODE OPERATION

The power supply will operate in constant voltage mode whenever the load current  $I_L$  **is less than** the current limit setting  $I_{SET}$ , or:  $I_L < I_{SET}$  (Note:  $I_L = V_{SET} / R_L$ )

In constant voltage mode, the power supply maintains the output voltage at the selected value ( $V_{SET}$ ) while the load current  $I_L$  varies with the load requirements.

### CONSTANT CURRENT MODE OPERATION

The power supply will operate in constant current mode whenever the load resistance is low enough that the load current  $I_L$  **is greater than** the current limit setting  $I_{SET}$ , or:  $I_L > I_{SET}$

In constant current mode, the power supply maintains the output current at the selected value ( $I_{SET}$ ) while the load voltage varies with the load requirements.

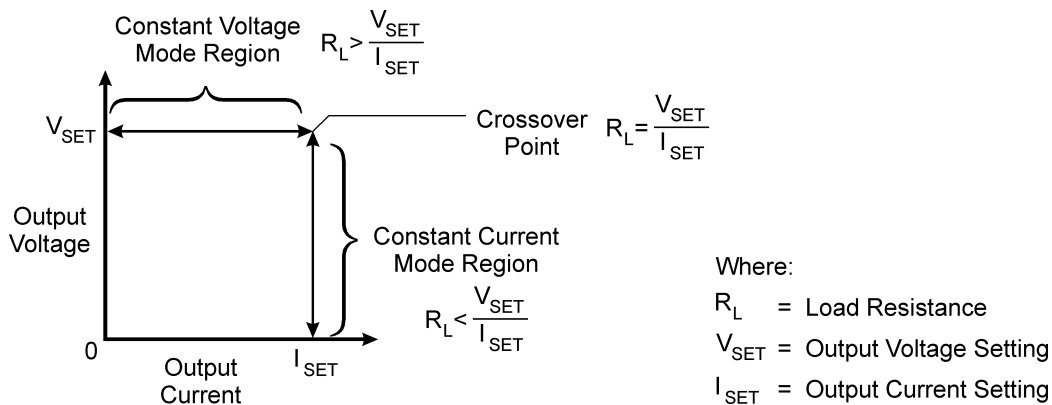

**Figure 3-1 Operating Modes**

### AUTOMATIC MODE CROSSOVER

This feature allows the power supply to automatically switch operating modes in response to changing load requirements. If, for instance, the power supply was operating in Constant Voltage Mode ( $I_L < I_{SET}$ ), and the load changed so that the load current ( $I_L$ ) became **greater than** the current limit setting ( $I_{SET}$ ), the power supply would automatically switch into Constant Current Mode. If the additional load was subsequently removed so that the load current was again **less than** the current limit setting, the supply would automatically return to Constant Voltage Mode.



### 3.2.2 Local Programming Mode Operation

Units are shipped from the factory configured for local programming mode operation. In local programming mode:

- Output voltage and current limit settings are adjusted with the front panel controls.
- The sense point of the supply is at the output terminals.
- The front panel OVP potentiometer determines the OVP set point. See **Section 4.4 Using Over Voltage Protection (OVP)** for the adjustment procedure.

#### LOCAL MODE DEFAULT CONFIGURATION

**Figure 3-2** shows the default factory settings for the internal jumpers JMP1 and JMP2, for switch SW1, and for rear panel connector J3. These controls are used to select among the various options for programming, sensing, and monitoring. See **Section 4.2 Configuring for Remote Programming, Sensing, and Monitoring**.

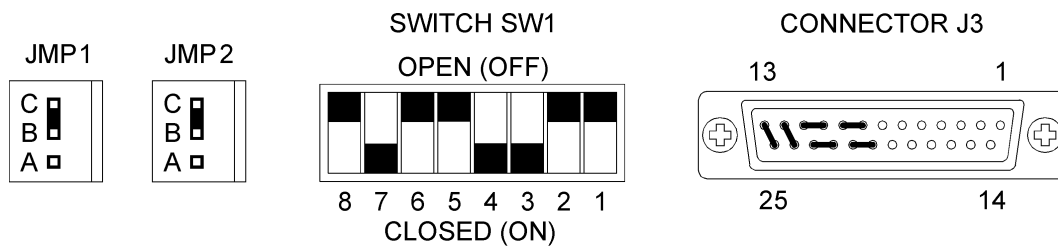

**Figure 3-2 Local Mode Default Configuration**

#### SETTING OUTPUT VOLTAGE AND CURRENT LIMIT

After installing the power supply and connecting the load as described in **Section 2 Installation**, set the required output voltage and current limit according to the following front panel procedure:

1. Turn both the voltage and current controls fully counter-clockwise.
2. Turn the AC power ON.
3. Press the STANDBY switch to its IN position to disable the power supply output.
4. Press and hold the V & I CHECK button to display the voltage and current control settings on the voltmeter and ammeter displays.
5. Adjust the voltage control to the required voltage (the compliance voltage for applications using current mode operation).
6. Adjust the current control to the required current limit setting.
7. Release the V & I CHECK button.
8. Press the STANDBY switch to its OUT position to apply power to the load.

### 3.3 USING REMOTE SENSING

Remote sensing is used during voltage mode operation to shift the power supply's regulation point from its output terminals (default sense point) to the load or distribution terminals by using a separate pair of wires to monitor the load voltage. Remote sensing allows the power supply to compensate for voltage losses in the load lines (up to 1V per line) which will otherwise degrade the regulation of the supply. The sense line connection points are located on the rear panel J3 connector. See **Section 4.2** for more information about making J3 connector changes.



**CAUTION!**

**Do not use remote sensing with multiple supplies connected in series or in parallel.**

#### 3.3.1 Connecting Remote Sense Lines

To connect remote sense lines, refer to **Figure 3-3** and to the following procedure:

1. Ensure the power supply is turned OFF. Allow five (5) minutes to elapse to dissipate stored energy before altering J3 connector pin connections.
2. Remove the local sense jumpers connecting J3 pins 13 to 25 (positive sense) and pins 12 to 24 (negative sense or return sense).
3. Connect the positive sense lead to pin 13 and the negative lead to pin 12. Use shielded-twisted pair wiring of 24 AWG or larger for sense lines.
4. Ground the sense line shield, at one point only, to the power supply's return output connection at the load, or, to the power supply's return output at its output terminal, or to the power supply's chassis.
5. The optimal point for the shield ground must be determined by experiment, but the most common connection point is at the power supply's return output connection at the load.
6. Turn the power supply ON.

#### Notes:

1. If the power supply is operated with remote sense lines connected and with either of the positive or negative load lines **not** connected, the power supply shutdown circuit will be activated, causing the output voltage and current to fall to zero.
2. If the power supply is operated **without** remote sense lines **or** local sense jumpers in place, the supply will continue to work, but supply regulation will be degraded and/or erratic.

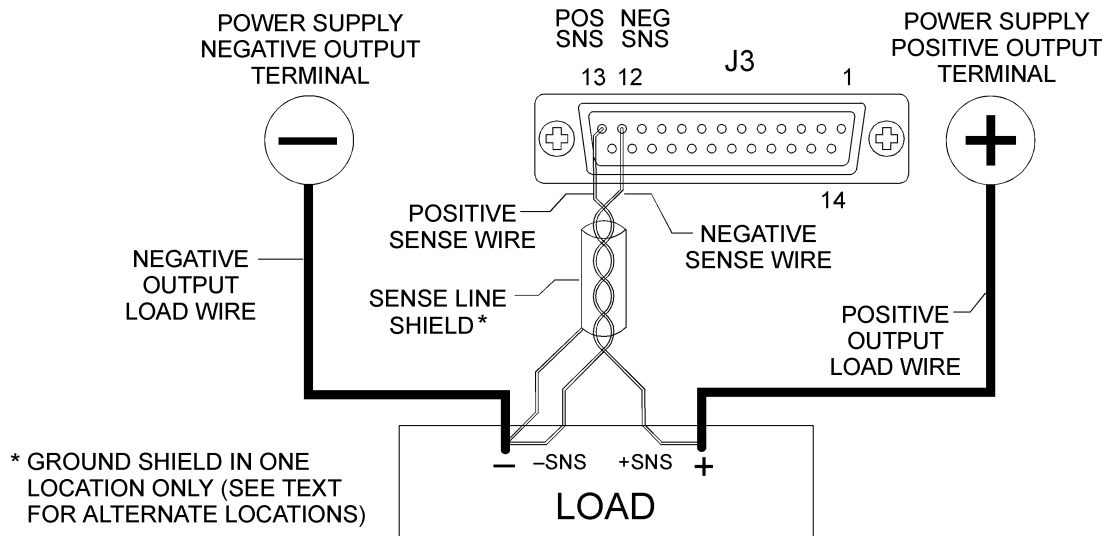

**Figure 3-3 Connecting Remote Sense Lines**



**CAUTION!** Do not use remote sensing with multiple supplies connected in series or in parallel.

This page intentionally left blank.

# SECTION 4

## ADVANCED OPERATION

### 4.1 INTRODUCTION

All DCS-E Series power supplies offer the following standard features:

- Remote Programming of Output Voltage and Current Limit with 0-5V, 0-10V, 0-1 mA, and 0-5k ohms (**Section 4.3**)
- Overvoltage Protection (OVP) with front panel controls or 0-5V and 0-10V programming (**Section 4.4**)
- Programmable Shutdown with AC, DC, or TTL compatible signals and contact closure (**Section 4.5**)
- Remote Monitoring of Status Indicators for thermal shutdown, OVP status, remote/local programming mode, and voltage/current mode operation (**Section 4.6**)
- Calibrated Readback Signals for output voltage and output current with selectable 0-5V or 0-10V scales (**Section 4.6**)
- Multiple Supply Configurations such as series, parallel, and split supply (**Section 4.7**)
- Remote Voltage Sensing (**Section 3.3**)
- Output Voltage Biasing (**Section 4.8**)

Accessing these features may require that you use one or more of the following procedures:

- Using the front panel REM/LOC (Remote/Local Programming) switch.
- Reconfiguring the rear panel J3 connector.
- Making connections to the J3 connector.
- Resetting internal jumpers JMP1 and JMP2.
- Resetting internal switch SW1.

## 4.2 CONFIGURING FOR REMOTE PROGRAMMING, SENSING, AND MONITORING

This section lists switch, connector, and jumper functions for the DCS-E Series (3kW) supply. Subsequently, it provides a location diagram (**Section 4.2.2**), in addition to procedures for resetting the internal jumpers and switches (**Section 4.2.3**), and for reconfiguring or making connections to the J3 connector (**Section 4.2.4**).

You will find remote programming procedures and diagrams covered in more detail in **Section 4.3**, remote sensing in **Section 3.3**, and remote monitoring of readback signals and status indicators in **Section 4.6**.

### 4.2.1 Programming, Monitoring, and Control Functions

#### FRONT PANEL REM/LOC SWITCH

You can use the REM/LOC (Remote/Local Programming) switch for remote programming. When set to REM (Remote Programming), control of BOTH output voltage AND current limit is passed to external voltage and/or current sources which are connected to the J3 connector. Resetting the switch to LOC returns the supply to local (front panel) control. See **Section 4.3** for more information about using this switch.

#### EXTERNAL J3 CONNECTOR

The external J3 connector provides user access to the following functions:

- Remote programming of output voltage OR current limit, and for OVP
- Remote monitoring of the following readback signals and status indicators

Readback Signals	Status Indicators
Calibrated output voltage	Thermal shutdown
Calibrated output current	OVP circuit
	Remote/local programming mode

- Remote programming of the shutdown function using AC, DC, or TTL compatible signals
- Remote sensing of output voltage

See **Figure 4-1 Connector J3**.



**WARNING!**

Use extreme caution when biasing the output relative to the chassis due to potential high voltage levels at the output and J3 terminals.

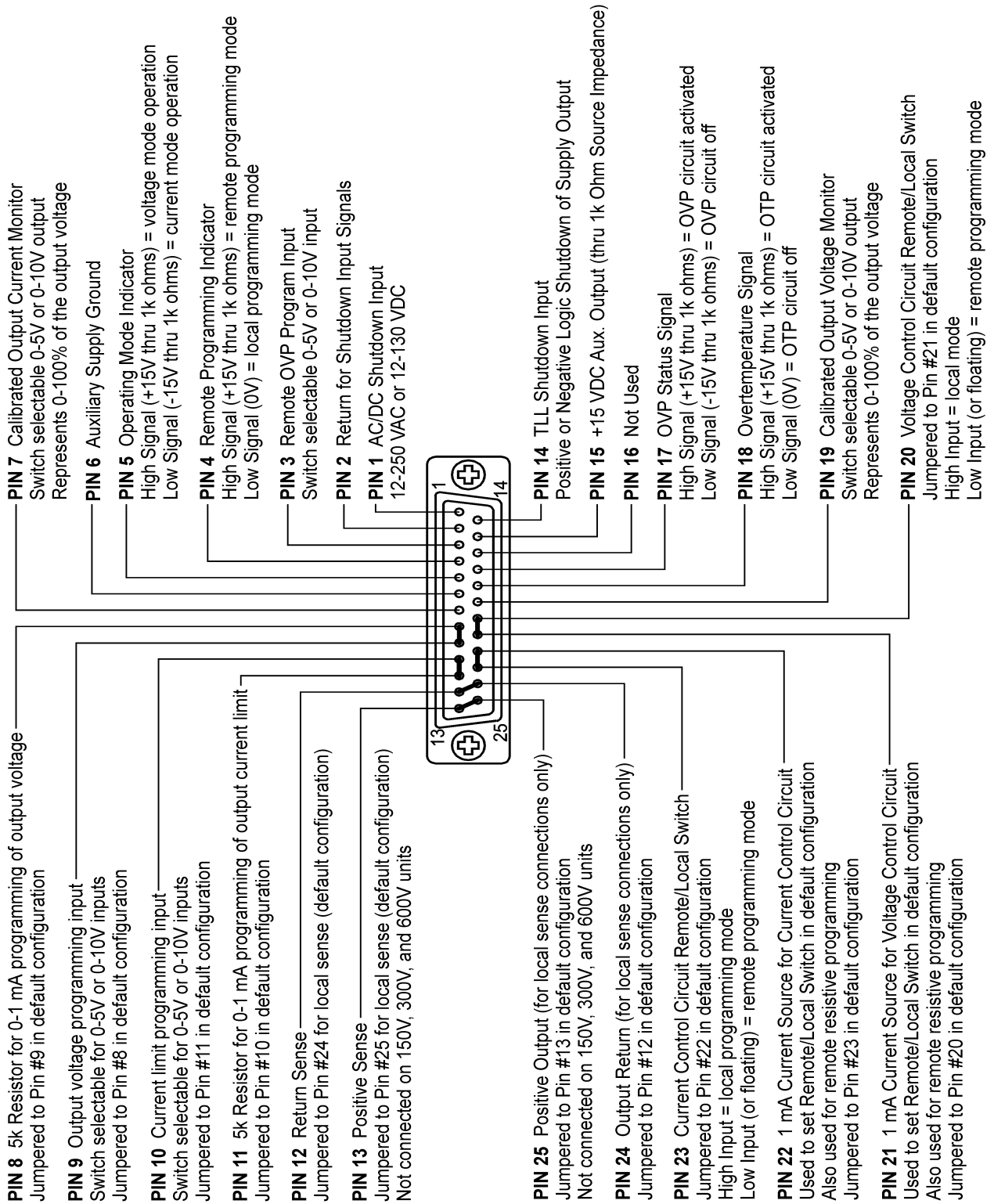

**Figure 4-1 Connector J3 Pin Descriptions  
(for Remote Programming, Remote Monitoring, and Sense Connections)**

**INTERNAL SWITCH AND JUMPERS**

If you should need to change any of the standard configurations of the supply, internal jumpers JMP1 and JMP2, and switch SW1 enable you to select: voltage and current programming scale factor, over voltage protection (OVP) programming mode and scale, voltage and current monitor range, and shutdown circuit logic.

4.2.2 Locating Jumpers, Switch, and Connector

Switch SW1 and jumpers JMP1 and JMP2 are located on the main printed circuit board (A2) inside the power supply. The J3 connector is located on the unit's rear panel. See **Section 4.2.3 Resetting Jumpers and Switch** and **Section 4.2.4 Making J3 Connections**.

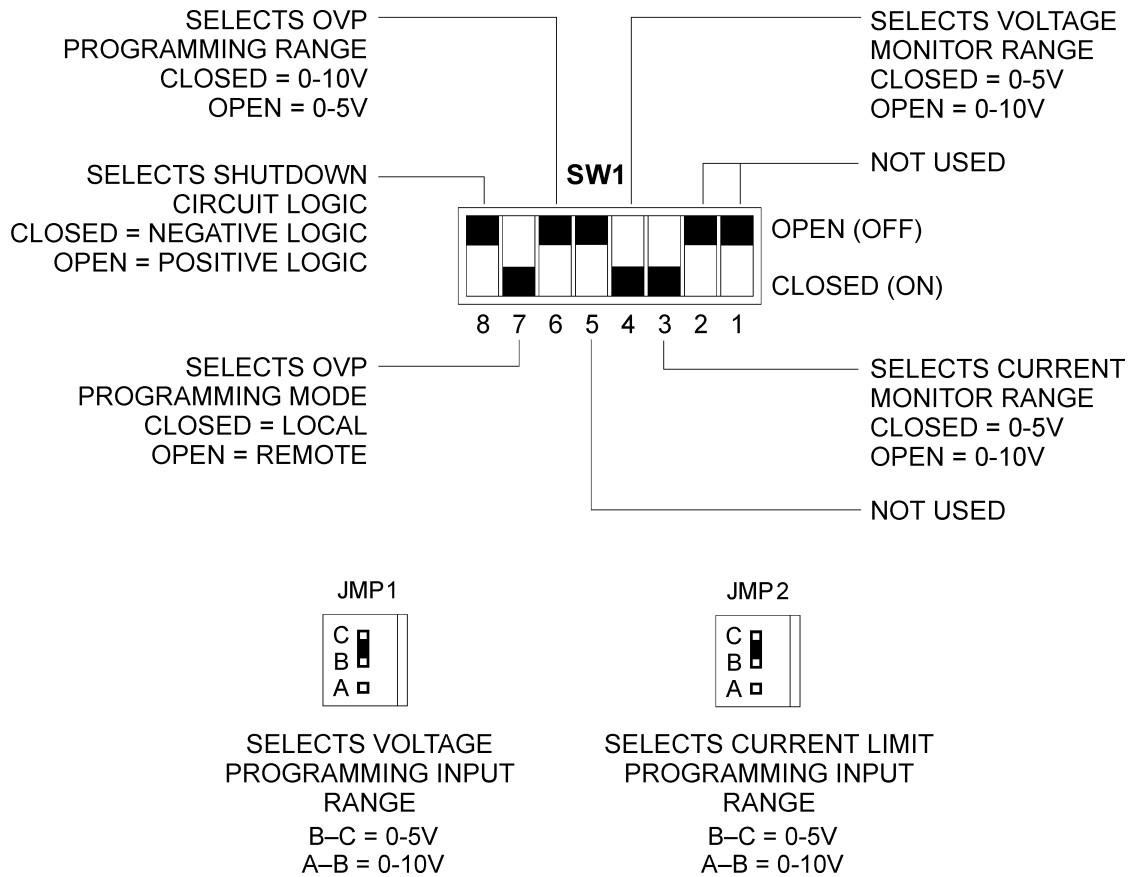

**Figure 4-2 Internal Jumpers and Switch (Default Settings Shown)**



### 4.2.3 Resetting Jumpers and Switch

Most applications will use the default factory settings of the internal jumpers, JMP1 and JMP2, or of the internal 8-position DIP switch, SW1. If the jumpers and switch should require resetting, read **Section 2.2 Safety**, and follow the procedures in this section.

The steps to follow are:

- Dissipating stored energy
- Removing the cover
- Removing the option board (when required)
- Resetting JMP1, JMP2 and SW1
- Replacing the option board
- Replacing the cover
- Powering up

#### **DISSIPATING STORED ENERGY**

1. Ensure the power supply is turned OFF. Disconnect the AC input connector. Allow five (5) minutes to elapse to dissipate stored energy before removing the cover.

#### **REMOVING THE COVER**

2. Unscrew and remove the eight (8) flathead Philips screws from the top of the cover: two (2) are located near the front panel, six (6) near the rear panel. (Use a #1 Philips screwdriver.)
3. Loosen but do not remove the six (6) Philips screws located three (3) to a side in the slots along each side of the power supply.
4. Lift cover off and set aside.

#### **REMOVING THE OPTION BOARD (WHEN REQUIRED)**

The power supply may have either of two option circuit boards installed over the A2 circuit board where the jumpers and switches are located. The option board must be removed to allow access to them.

5. Unplug any external mating connector and attached wiring.
6. Use a nut driver to remove the jackscrews that fasten the option board to the rear panel.
7. Unscrew the mounting screws that fasten the option board down.
8. Unplug any attached cables.
9. Lift out the option board and set aside.

#### **RESETTING JMP1, JMP2, AND SW1**

10. Lift the appropriate jumper from its pin header and replace it as the programming requires. The default location is B-C for both JMP1 and JMP2. Alternate locations are A-B in each case.
11. Push the dual position SW1 switches closed (ON) or open (OFF) as required by the application.

**REPLACING THE OPTION BOARD (WHEN REQUIRED)**

12. Place the option board into its original location over the A2 circuit board.
13. Reinstall the mounting screws into the standoffs. Reattach any cables.
14. Reinstall the jackscrews with the nut driver.
15. Reconnect any external cables and connector.

**REPLACING THE COVER**

16. Place the cover in its original location.
17. Reinstall the eight (8) flathead Philips screws on the top of the cover, then tighten the six (6) Philips screws in the side slots.

**POWERING UP**

18. Reconnect the AC input connector. Turn the power supply ON.

**4.2.4 Making J3 Connections**

Some applications will use only the default factory connections on the J3 connector located on the rear panel. Other applications will require replacing pin-to-pin connections or making connections to external devices such as voltage sources, current sources, or resistances. Read **Section 2.2 Safety**, and follow the procedures in this section whenever the rear panel connector, J3, is to be reconfigured.

The steps to follow are:

- Dissipating stored energy
- Making the connections
- Powering up

Refer to the **DISSIPATING STORED ENERGY** and **POWERING UP** steps in **Section 4.2.3**.

**MAKING THE CONNECTION**

To make pin-to-pin connections:

1. Unsolder any pin-to-pin jumpers as required by the application.
2. Solder new connections using any appropriate single bus wire such as AWG 20 to 24.

To connect external source leads, resistance leads, or monitoring or sense lines:

3. Unsolder any jumpers as required by the application.
4. Solder leads to the specified pin using the recommended wiring and/or grounding point for the application. Pin, wiring, and grounding specifications for particular applications can be found in **Section 4 Advanced Operation** except for remote sensing specifications that are in **Section 3.3 Using Remote Sensing**.

### 4.3 REMOTE PROGRAMMING: OUTPUT VOLTAGE AND CURRENT LIMIT

Remote programming allows control of the power supply's output voltage and/or current limit to shift from local operation at the front panel voltage and current controls to external analog input sources. As a programming source is varied, the power supply's output varies proportionally over its output range.

The analog programming signals are connected to the rear panel J3 connector. To provide the lowest noise performance, **shielded-twisted pair wiring is recommended for making connections from external circuits to the J3 connector**. Use the shortest leads possible. Ground the shield to pin 6 on J3 or to the chassis via one of the J3 connector screws.

 <b>CAUTION!</b>	<p>The remote programming input is internally referenced to the supply's negative output. Do not connect remote programming input lines (J3 pins 9 and 10) to the supply's positive output.</p>
--	---

#### REMOTE PROGRAMMING OPTIONS

The following table summarizes access options for programming output voltage and current limit with the input scales supported for the DCS-E Series (3kW) supply. Refer to **Section 4.3.1** for a procedure and a connection diagram for programming output voltage and current limit using the REM/LOC switch. Subsequent sections provide short procedures and diagram the J3 connector configurations and connections required for remote programming of output voltage and/or current limit without using the REM/LOC switch.

Remote Programming Options	Control of ...	Programming Scales *
Programming with the REM/LOC Switch	Output Voltage and Current Limit	0-5V 0-1 mA 0-10V (see Notes below)
Programming without the REM/LOC Switch	Output Voltage and/or Current Limit	0-5V, 0-10V 0-1 mA 0-5k Local control 0-10V (see Notes below)

\* These scales may be used in any combination.

Notes for Programming with a 0-10V Source:

1. Programming with a 0-10V external voltage source requires that you reset internal jumpers JMP1 and/or JMP2 in addition to performing any external operations. As in any situation that requires removing the supply's cover, following safe procedures is necessary. Review **Section 2.2 Safety** and follow the procedures for removing the cover and resetting JMP1 and JMP2 in **Section 4.2.3**.
2. Resetting internal jumpers may require a recalibration of the programming circuit to maintain programming accuracy. See **Section 6.3 Calibrating for Programming Accuracy**.

**Section 4.2 Configuring for Remote Programming, Sensing, and Monitoring** explains how to use the front panel REM/LOC switch, how to reconfigure or make connections to the external J3 connector, and how to access internal jumpers JMP1 and JMP2 to change their settings.

#### 4.3.1 Programming Output Voltage and Current Limit with the REM/LOC Switch

The front panel REM/LOC (Remote/Local Programming) switch will allow you to switch back and forth between remote and local operation when programming output voltage and current limit with external voltage and/or current sources.

For programming output voltage and current limit using the REM/LOC switch:

1. Connect the programming source between pins 9 (voltage programming input/positive) and 12 (return).
2. Connect the programming source between pins 10 (current limit programming input/positive) and 12 (return).
3. Set the front panel REM/LOC switch to REM.

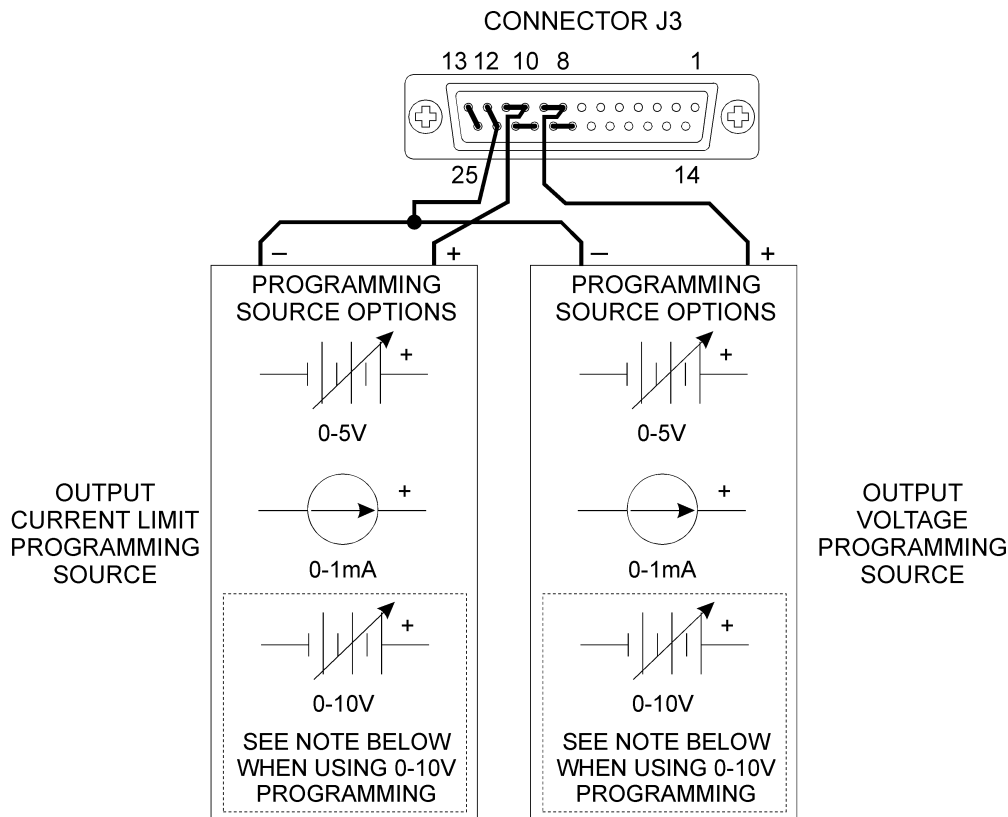

**Figure 4-3 Programming Output Voltage and Current Limit Using the REM/LOC Switch**

#### Notes for 0-10V Programming:

1. To program both output voltage and current limit with a 0-10V source and use the REM/LOC switch, set internal jumpers JMP1 and JMP2 to their A-B locations before connecting the voltage and current limit programming inputs. Review **Section 2.2 Safety** and follow the

procedures for removing the cover and resetting JMP1 and JMP2 in **Section 4.2.3 Resetting Jumpers and Switch.**

- Resetting internal jumpers may require recalibration of the programming circuit to maintain programming accuracy. See **Section 6.3 Calibrating for Programming Accuracy.**

#### 4.3.2 Programming Output Voltage

##### PROGRAMMING OUTPUT VOLTAGE WITH A 0-5 VDC SOURCE

- Remove the jumpers connecting pins 8 to 9 and 20 to 21 on connector J3.
- Connect the external programming source between pins 9 (voltage programming input/positive) and 12 (return).

Varying the programming voltage from 0 to 5 Vdc will cause the output to vary from 0 to 100% of the model rating. The output current limit may be programmed using another source or set locally by adjusting the front panel current limit control.

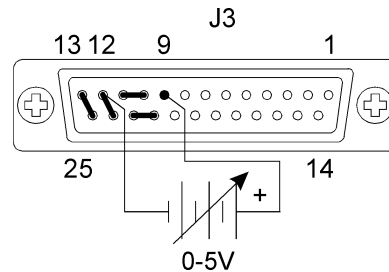

**Figure 4-4 Programming Output Voltage with a 0-5 Vdc Source**

##### PROGRAMMING OUTPUT VOLTAGE WITH A 0-10V SOURCE

- Set jumper JMP1 to its A-B location.
- Remove the jumpers connecting pins 8 to 9 and 20 to 21 on connector J3.
- Connect the external voltage programming source between pins 9 (voltage programming input/positive) and 12 (return).

Varying the programming voltage from 0 to 10 Vdc will cause the output voltage to vary from 0 to 100% of the model rating. The output current limit may be programmed using another source or set locally by adjusting the front panel current control.

**Note:** Resetting internal jumpers may require a recalibration of the programming circuit to maintain programming accuracy. See **Section 6.3 Calibrating for Programming Accuracy.**

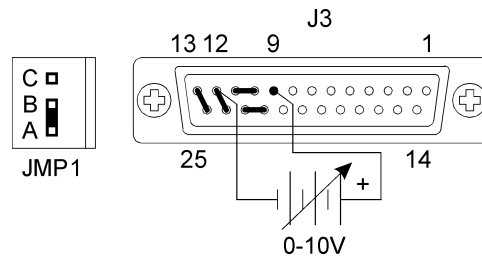

**Figure 4-5 Programming Output Voltage with a 0-10 Vdc Source**



**WARNING**

Exercise caution when resetting internal jumpers. Review **Section 2.2 Safety** and follow procedures for removing the cover and resetting jumpers in **Section 4.2.3 Resetting Jumpers and Switch**.

**PROGRAMMING OUTPUT VOLTAGE WITH A 0-1 mA SOURCE**

1. Remove the jumper between pins 20 and 21 of connector J3.
2. Connect the external programming source between pin 9 (voltage programming input/positive) and pin 12 (return) of connector J3.

Varying the current source from 0 to 1 mA will vary the output voltage from 0 to 100% of the model rating. Adjusting the front panel current limit control sets the output current limit.

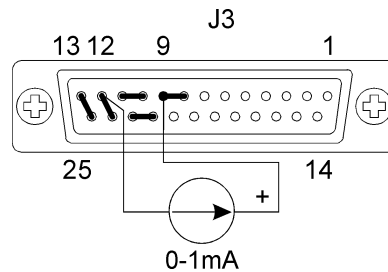
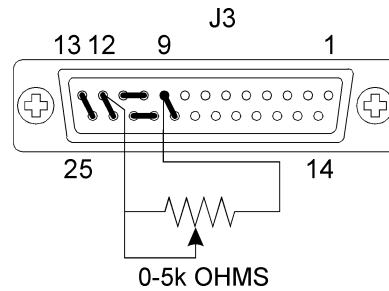

**Figure 4-6 Programming Output Voltage with a 0-1 mA Source**

**PROGRAMMING OUTPUT VOLTAGE WITH A 0-5K RESISTANCE**

1. Remove the jumpers connecting pins 8 to 9 and pins 20 to 21 on connector J3.
2. Connect pins 9 (voltage programming input/positive) and 21 (1 mA current source for voltage control) to the counter-clockwise end of the 5k potentiometer and connect the tap and clockwise end of the potentiometer to pin 12 (return).

Adjusting the resistance from 0 to 5k will vary the output voltage from 0 to 100% of the model rating. The output current limit is set locally by adjusting the front panel current limit control.



**Figure 4-7 Programming Output Voltage with a 5k ohm Resistance**

### 4.3.3 Programming Output Current Limit

#### PROGRAMMING OUTPUT CURRENT LIMIT WITH A 0-5 VDC SOURCE

1. Remove the jumpers connecting pins 10 to 11 and 22 to 23 on connector J3.
2. Connect the external programming source between pins 10 (current limit programming input/positive) and 12 (return).

Varying the programming voltage from 0 to 5 Vdc will cause the current limit to vary from 0 to 100% of the model rating. The output voltage is set locally by adjusting the front panel voltage control.

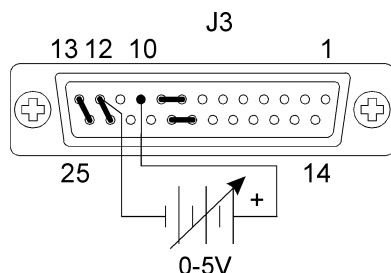

**Figure 4-8 Programming Output Current Limit with a 0-5 Vdc Source**

#### PROGRAMMING OUTPUT CURRENT LIMIT WITH A 0-10 VDC SOURCE

1. Set jumper JMP2 to its A-B location.
2. Remove the jumpers connecting pins 10 to 11 and 22 to 23 on connector J3.
3. Connect the external current programming source between pins 10 (current limit programming input/positive) and 12 (return).

Varying the programming voltage from 0 to 10 Vdc will cause the output current limit to vary from 0 to 100% of the model rating. The output voltage is set locally by adjusting the front panel voltage control.

**Note:** Resetting internal jumpers may require a recalibration of the programming circuit to maintain programming accuracy. See **Section 6.3 Calibrating for Programming Accuracy**.

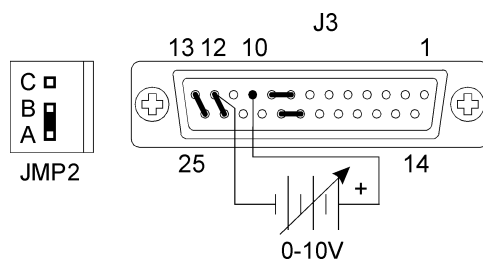

**Figure 4-9 Programming Output Current Limit with a 0-10 Vdc Source**





Exercise caution when resetting internal jumpers. Review **Section 2.2 Safety** and follow procedures for removing the cover and resetting jumpers in **Section 4.2.3 Resetting Jumpers and Switch.**

#### PROGRAMMING OUTPUT CURRENT LIMIT WITH A 0-1 mA SOURCE

1. Remove the jumper between pins 22 and 23 of connector J3.
2. Connect the external programming source between pin 10 (current limit programming input/positive) and pin 12 (return) of connector J3.

Varying the current source from 0 to 1 mA will vary the output voltage from 0 to 100% of the model rating. Adjusting the front panel voltage control sets the output voltage.

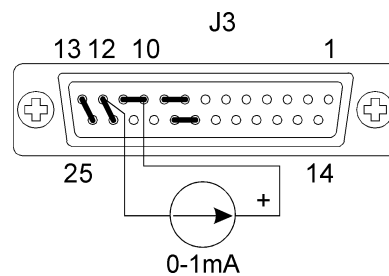
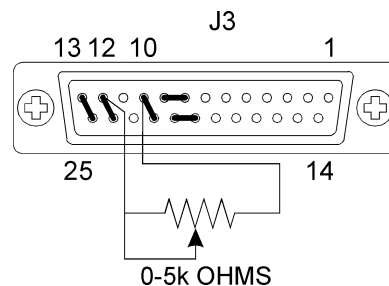

**Figure 4-10 Programming Output Current Limit with a 0-1 mA Source**

#### PROGRAMMING OUTPUT CURRENT LIMIT WITH A 0-5k RESISTANCE

1. Remove the jumpers connecting pins 10 to 11 and pins 22 to 23 on connector J3.
2. Connect pins 10 (current limit programming input/positive) and 22 (1 mA current source for current control) to the counterclockwise end of the 5k potentiometer and connect the tap and clockwise end of the potentiometer to pin 12 (return).

Adjusting the resistance from 0 to 5k will vary the current limit from 0 to 100% of the model rating. Adjusting the front panel voltage control sets the output voltage.



**Figure 4-11 Programming Output Current Limit with a 5k ohm Resistance**

## 4.4 USING OVER VOLTAGE PROTECTION (OVP)

The OVP circuit allows for protection of the load in the event of a remote programming error, an incorrect voltage control adjustment, or a power supply failure. The protection circuit monitors the output voltage and will reduce the output current and voltage to zero whenever a preset voltage limit is exceeded. The preset voltage limit, also called the set point or trip level, can be set either in local programming mode from the front panel or by remote programming through the J3 connector on the rear panel.

The red OVP LED on the front panel will light up when the OVP circuit has been activated.

### 4.4.1 Front Panel OVP Operation

In local programming mode, the OVP set point can be checked at any time by pressing the OVP CHECK switch: the OVP set point is the value displayed on the digital voltmeter.

To set the trip level from the front panel:

1. Adjust the power supply output to zero volts.
2. Press the OVP CHECK switch to observe the OVP set point on the voltmeter display.
3. Turn the OVP SET potentiometer until the desired set point is reached. Release the OVP CHECK switch.
4. Increase the power supply output voltage to check that the power supply shuts off the output at the selected set point.

### 4.4.2 Resetting the OVP Circuit

To reset the OVP circuit after it has been activated:

1. Reduce the power supply's output voltage setting to below the OVP set point.
2. Press the STANDBY switch IN. The Shutdown (S/D) LED on the front panel will light up.
3. Press the STANDBY switch again to return power to the load and resume normal operation.

OR

1. Reduce the power supply's output voltage setting to below the OVP set point.
2. Turn the power supply OFF using the AC power switch, then turn it back ON again.

### 4.4.3 Programming OVP with an External Voltage Source

To set the OVP trip level with a 0-5 Vdc or a 0-10 Vdc external voltage source:

1. Ensure the power supply is turned OFF and that both the AC power source and the load are disconnected. Allow five (5) minutes to elapse to dissipate stored energy before resetting switches or making connections. Refer to **Section 4.2** for instructions for removing the cover and resetting switches or making J3 connections.
2. Set the power supply's internal switch SW1-7 OPEN. Ensure switch SW1-6 is set to OPEN for 0-5 Vdc OVP programming (factory default setting) or set it to CLOSED for 0-10 Vdc OVP programming. See **Figure 4-12** and **Figure 4-13**.
3. Connect the external voltage source between pin 3 (positive) and pin 12 (return) on the J3 connector on the rear panel. See **Figure 4-12** and **Figure 4-13**. The use of shielded-twisted pair wiring is recommended. Ground the shield to J3 connector pin 6 or to the chassis using one of the J3 connector screws.
4. Set the external programming source voltage to maximum (5 Vdc or 10 Vdc).
5. Turn the power supply ON and turn the front panel voltage control clockwise until the voltmeter shows the desired trip voltage.
6. Slowly reduce the external programming voltage until the red OVP LED lights and the power supply shuts down.

**Note:** When OVP is programmed by an external voltage source, the OVP set point can be approximated using the following formula:

$$\text{OVP Set Point } \pm 2\% = (V_o / \text{PGM}_{\text{SCALE}}) V_{\text{PGM}}$$

where:  $V_o$  is the power supply model-rated voltage

$\text{PGM}_{\text{SCALE}}$  is the external voltage source maximum voltage (5 or 10)

$V_{\text{PGM}}$  is the remote OVP program voltage setting (0 to 5 Vdc or 0 to 10 Vdc)

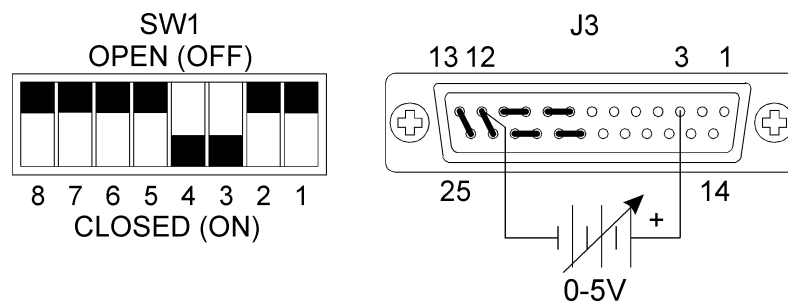

**Figure 4-12 Remote Programming of OVP with a 0-5 Vdc External Voltage Source**

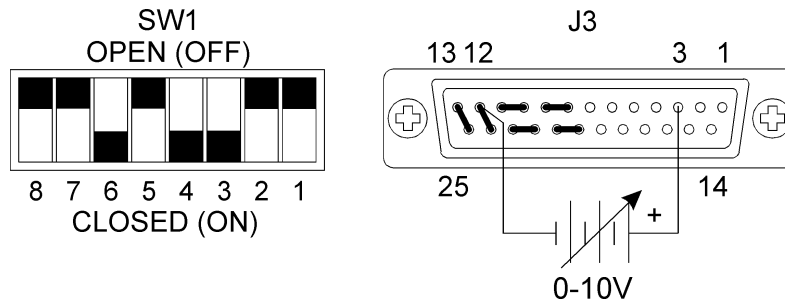

**Figure 4-13 Remote Programming of OVP with a 0 –10 Vdc External Voltage Source**

## 4.5 USING THE SHUTDOWN FUNCTION

The Shutdown function is used to disable or enable the supply's output voltage and current. It can be used to allow adjustments to be made to either the load or the power supply without shutting off the entire supply. This function may be activated from the front panel at any time by using the STANDBY switch. It can also be activated via remote programming, using positive or negative logic, with a TTL compatible input or with an AC or DC signal.

### 4.5.1 STANDBY Switch

The STANDBY switch is a press ON/press OFF switch located on the power supply's front panel. See front panel diagram in **Figure 1-1**. When pushed IN, or depressed, the Shutdown circuit is activated, the output voltage and current fall to zero and the S/D (Shutdown) LED on the front panel is illuminated. Pushing the switch once more resets it to its OUT position and normal power supply operation is resumed.

### 4.5.2 Programming the Shutdown Function

The Shutdown circuit uses either a TTL compatible signal, or a 12-250 Vac or 12-130 Vdc input, to disable or enable the power supply output. Connections for TTL, AC, or DC input signals are made at connector J3. Internal switch SW1-8 settings determine whether positive or negative logic for the signal is used. The input lines for the Shutdown circuit are optically isolated and can therefore be used by input sources with a voltage differential of up to 400 Vdc.

### EXTERNAL WIRING

Use 20 to 24 AWG wiring when making connections to the J3 connector. Keep wiring as short as possible.

### TTL SHUTDOWN

To activate the Shutdown function using a TTL compatible input:

1. Turn off the power supply and disconnect the AC power source. Allow five (5) minutes to elapse to dissipate stored energy before making connections or resetting switches.

2. Connect the TTL signal source to pin 14 (TTL Shutdown Input/positive) and pin 2 (Return for Shutdown Input) on the J3 connector on the rear panel. See **Figure 4-14** and **Figure 4-15**.
3. Set internal switch SW1-8 to select the desired circuit logic as defined in the table below.

Switch SW1-8 Setting	TTL Signal Level	Output Condition
OPEN (Positive logic)	HIGH LOW	OFF ON
CLOSED (Negative logic)	HIGH LOW	ON OFF

The red S/D (Shutdown) LED on the front panel lights up when the Shutdown circuit is activated.

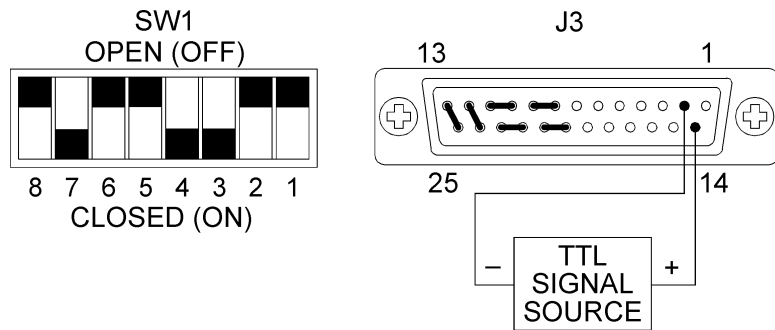

TTL SIGNAL HIGH = OUTPUT OFF  
TTL SIGNAL LOW = OUTPUT ON

**Figure 4-14 Using Shutdown with a TTL Compatible (Positive Logic)**

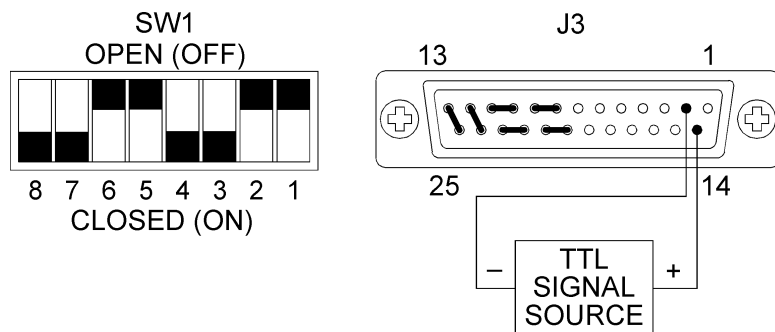

TTL SIGNAL HIGH = OUTPUT ON  
TTL SIGNAL LOW = OUTPUT OFF

**Figure 4-15 Using Shutdown with a TTL Compatible (Negative Logic)**

**AC/DC SHUTDOWN**

To activate the Shutdown function using a 12-250 Vac input or a 12-130 Vdc input:

1. Turn off the power supply and disconnect the AC power source. Allow five (5) minutes to elapse to dissipate stored energy before making connections or resetting switches.
2. Connect the AC or DC source to pin 1 (positive) and pin 2 (return) on the J3 connector on the rear panel. See **Figure 4-16** and **Figure 4-17**.
3. Set internal switch SW1-8 to select the desired circuit logic as shown in the table below.

Switch SW1-8 Setting	AC/DC Signal Level	Output Condition
OPEN (Positive)	ON	OFF
	OFF	ON
CLOSED (Negative)	ON	ON
	OFF	OFF

The red S/D (Shutdown) LED on the front panel lights up when the Shutdown circuit is activated.

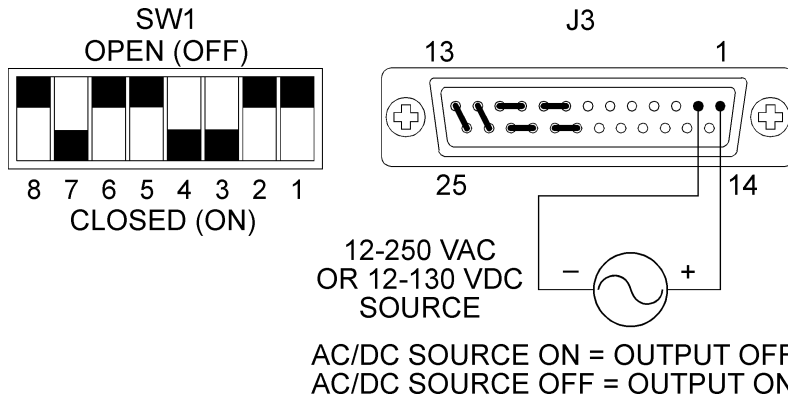

**Figure 4-16 Using Shutdown with an AC or DC Input (Positive Logic)**

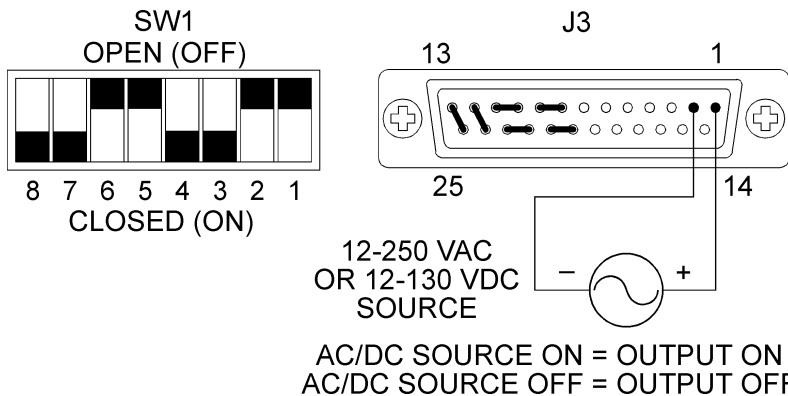

**Figure 4-17 Using Shutdown with an AC or DC Input (Negative Logic)**

### 4.5.3 Shutdown Application - Contact Closure

An external relay, whether normally open or normally closed, may be used to activate the Shutdown circuit. Either positive or negative logic may be used.

To activate the Shutdown function using an external relay:

1. Turn off the power supply and disconnect the AC power source. Allow five (5) minutes to elapse to dissipate stored energy before making connections or resetting switches. Refer to **Section 4.2** for instructions for resetting switches or making J3 connections.
2. Connect one side of the external relay to pin 15 (+15 Vdc Auxiliary Output) on connector J3. Connect the other side of the relay to pin 14 (TTL Shutdown Input). Also connect pin 2 (Shutdown Return) to pin 6 (Auxiliary Supply Ground). See **Figure 4-18** through **Figure 4-21**.
3. Set internal switch SW1-8 to select the desired circuit logic as shown in the table below.

Relay	Switch SW1-8 Setting	Relay Coil State	Output
Normally Open Relay	OPEN (Positive Logic)	Energized	OFF
		De-energized	ON
	CLOSED (Negative Logic)	Energized	ON
		De-energized	OFF
Normally Closed Relay	OPEN (Positive Logic)	Energized	ON
		De-energized	OFF
	CLOSED (Negative Logic)	Energized	OFF
		De-energized	ON

The red S/D (Shutdown) LED on the front panel lights up when the Shutdown circuit is activated.

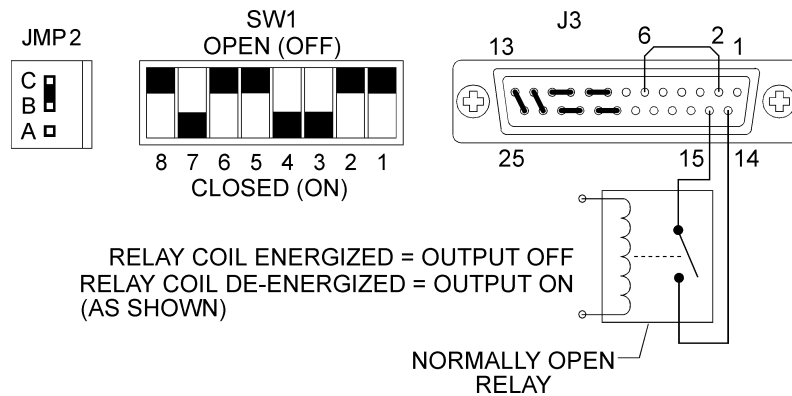

**Figure 4-18 Using Shutdown with Contact Closure of a Normally OPEN Relay (Positive Logic)**

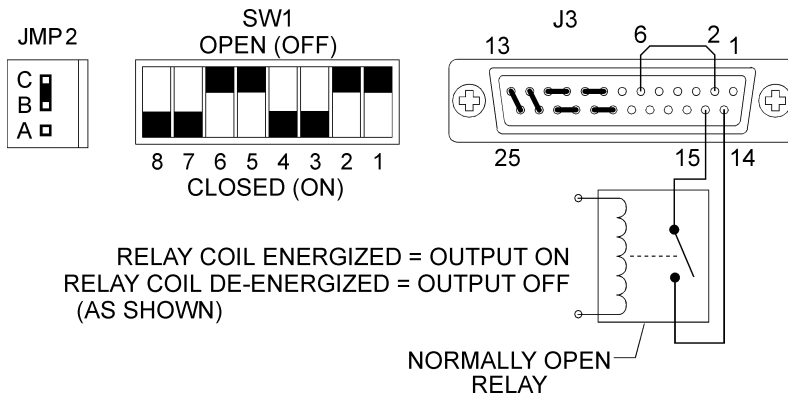

**Figure 4-19 Using Shutdown with Contact Closure of a Normally OPEN Relay (Negative Logic)**

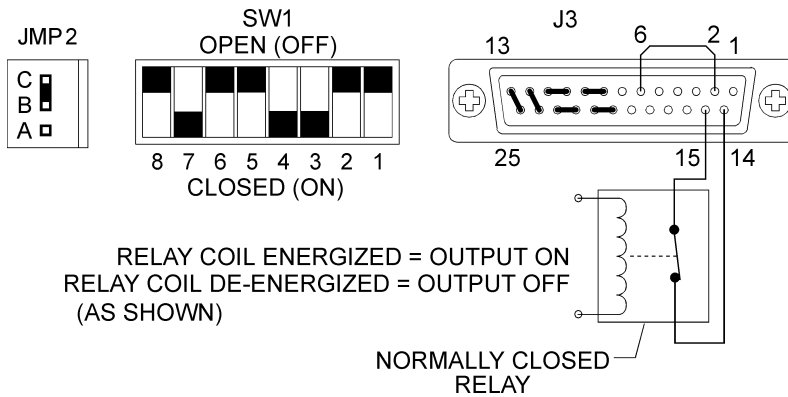

**Figure 4-20 Using Shutdown with Contact Closure of a Normally CLOSED Relay (Positive Logic)**

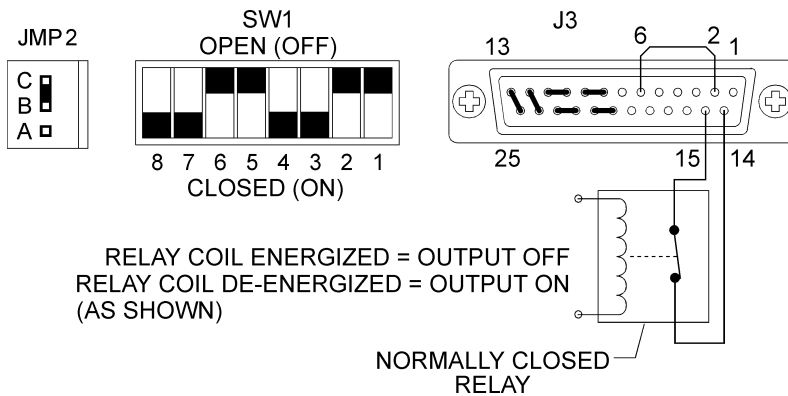

**Figure 4-21 Using Shutdown with Contact Closure of a Normally CLOSED Relay (Negative Logic)**



## 4.6 REMOTE MONITORING OF READBACK SIGNALS AND STATUS INDICATORS

### 4.6.1 Readback Signals

Calibrated readback signals for remote monitoring of the output voltage and current are available via connections at the J3 connector on the rear panel. Internal switch SW1 settings allow you to select either a 0-5 Vdc or a 0-10 Vdc range for the output. See **Section 4.2 Configuring for Remote Programming, Sensing, and Monitoring** for more information about making these connections.

The following table shows the required pin connections and switch settings for remote monitoring of readback signals with 0-5 Vdc or 0-10 Vdc outputs. Use shielded-twisted pair wiring (20 to 24 AWG) and ground the shield to J3 connector pin 6 or to the chassis via one of the J3 connector screws.

Readback Signal	J3 Connections:		Switch SW1 Settings:		Output Signal Range
	Signal (+)	Return (-)	Switch #	Setting	
Output Voltage	Pin 19	Pin 12	SW1-4	CLOSED	0-5 Vdc
				OPEN	0-10 Vdc
Output Current	Pin 7	Pin 12	SW1-3	CLOSED	0-5 Vdc
				OPEN	0-10 Vdc

The readback signal represents 0 to 100% of the model-rated output.

### 4.6.2 Status Indicators

Status indicators for thermal shutdown, OVP circuit, programming mode, and operating mode are available via connections on the J3 connector on the rear panel.

The following table shows the indicator signals, the J3 connector pin at which they are available, an approximation of the signal magnitude, and the source impedance through which the signal is fed. Use 20 to 24 AWG wiring.

Indicator Signal/ Alternate State	J3 Connections:		Signal Voltage	Source Impedance
	Signal (+)	Return (-)		
Thermal Shutdown/ Normal Operation	Pin 18	Pin 6	+13V	1k ohms
	Pin 18	Pin 6	0V	1k ohms
OVP Circuit Activated/ OVP Circuit Not Activated	Pin 17	Pin 6	+13V	1k ohms
	Pin 17	Pin 6	-13V	1k ohms
Remote Programming Mode/ Local Programming Mode	Pin 4	Pin 6	+13V	1k ohms
	Pin 4	Pin 6	0V	1k ohm
Voltage Mode Operation/ Current Mode Operation	Pin 5	Pin 6	+13V	1k ohms
	Pin 5	Pin 6	-13V	1k ohms

## 4.7 USING MULTIPLE SUPPLIES

DCS-E Series power supplies of the SAME MODEL may be operated with outputs in series or in parallel to obtain increased load voltage or increased current. Split supply operation allows two positive or a positive and a negative output to be obtained.

### 4.7.1 Configuring Multiple Supplies for Series Operation

Series operation is used to obtain a higher voltage from a single output using two or more supplies. Connect the negative (-) output terminal of one supply to the positive (+) output terminal of the next supply. See **Figure 4-22**. The total voltage available is the sum of the maximum voltages of each supply (add voltmeter readings). The maximum allowable current for a series string of power supplies is the model-rated output current of a single supply in the string.

**Note:** The maximum allowable sum of the output voltages is 300 Vdc. This is limited by the voltage rating of certain internal components.



**CAUTION!**

Remote sensing must not be used during series operation.



**CAUTION!**

The remote programming input is internally referenced to the supply's negative output. Do not connect remote programming input lines (J3 pins 9 and 10) to the supply's positive output.

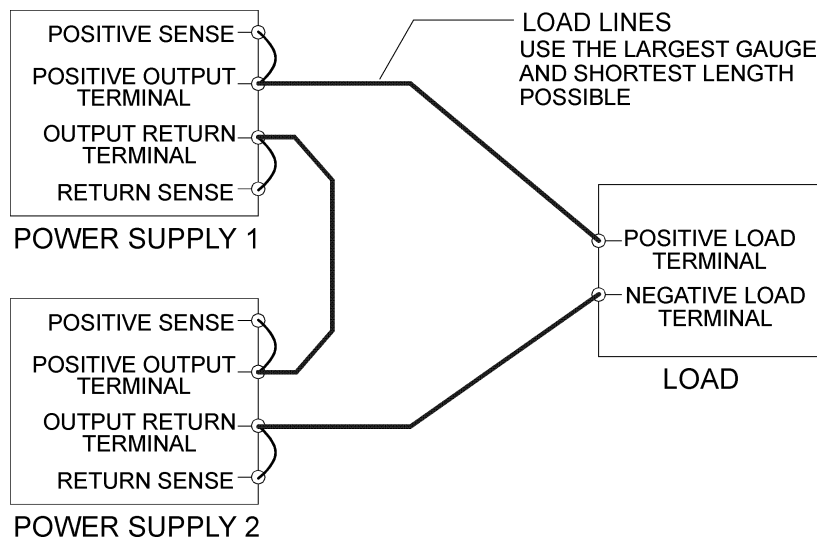

**Figure 4-22 Series Operation of Multiple Supplies**  
(Local sense lines shown are default J3 connections.)

### 4.7.2 Configuring Multiple Supplies for Parallel Operation

Parallel operation is used to obtain a higher current through a single output using two or more supplies. Set all of the outputs to the same voltage before connecting the positive (+) output terminals and negative (-) output terminals in parallel. See **Figure 4-23**. The total current available is the sum of the maximum currents of each supply.

**Note:** When operating multiple supplies in parallel, the operating mode of each supply will depend on the load current being drawn. For example, with two DCS 60-50E power supplies operating in parallel with a 75A load, one supply will operate in constant current mode supplying 50A and the other supply will operate in voltage mode supplying the remaining 25A.



#### CAUTION!

To prevent internal damage to the supplies, ensure that the Over Voltage Protection (OVP) trip level of all supplies is set to maximum.



#### CAUTION!

Remote sensing must not be used during parallel operation.

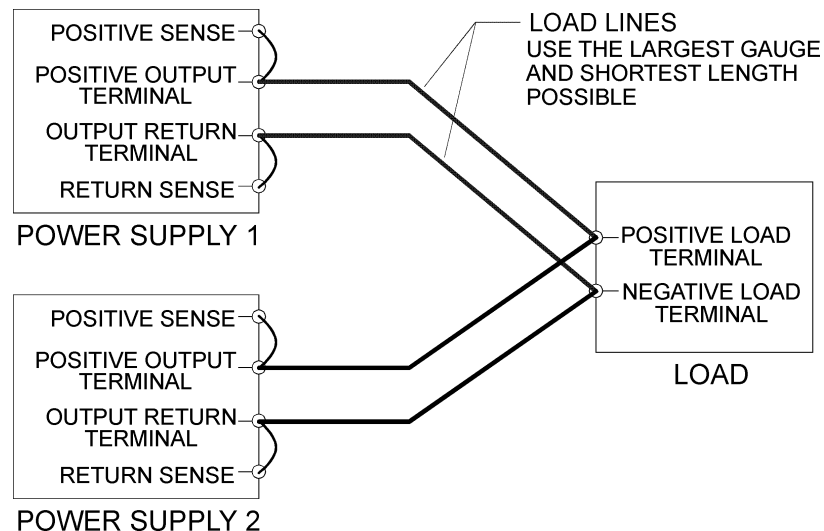

**Figure 4-23 Parallel Operation of Multiple Supplies**  
(Local sense lines shown are default J3 connections.)

### 4.7.3 Configuring Multiple Supplies for Split Supply Operation

Split supply operation uses two power supplies to obtain two positive voltages with a common ground, or to obtain a positive-negative supply.

To obtain **two positive voltages**, connect the negative output terminals of both supplies together. The positive output terminals will provide the required voltages with respect to the common connection. See **Figure 4-24**.

To obtain a **positive-negative supply**, connect the negative output terminal of one supply to the positive output terminal of the second supply. The positive output terminal of the first supply then provides a positive voltage relative to the common connection while the negative output terminal of the second supply provides a negative voltage. The current limits can be set independently. The maximum current available in split supply operation is equal to the model-rated output of the supplies used. See **Figure 4-25**.



**CAUTION!**

To prevent possible damage to the supply, do not connect the remote program return line of the negative supply to the common connection.

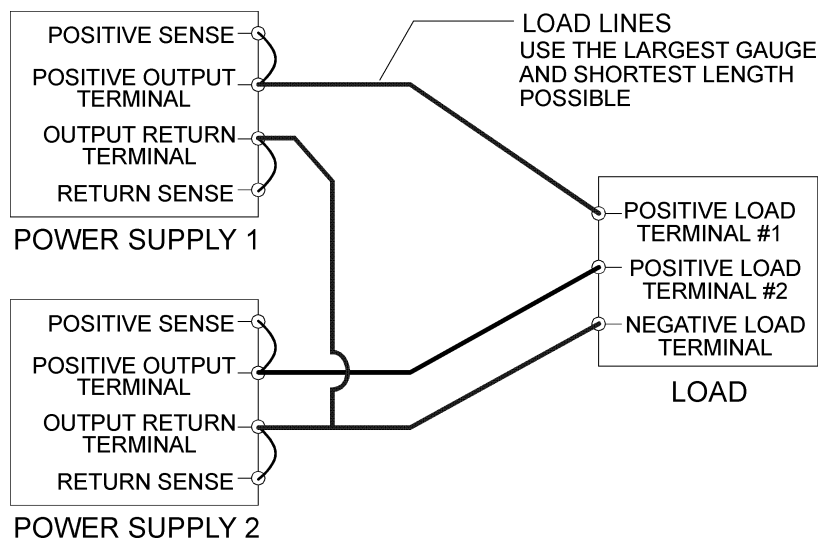

**Figure 4-24 Split Supply Operation of Multiple Supplies (Two Positive Voltages)**

*(Local sense lines shown are default J3 connections.)*

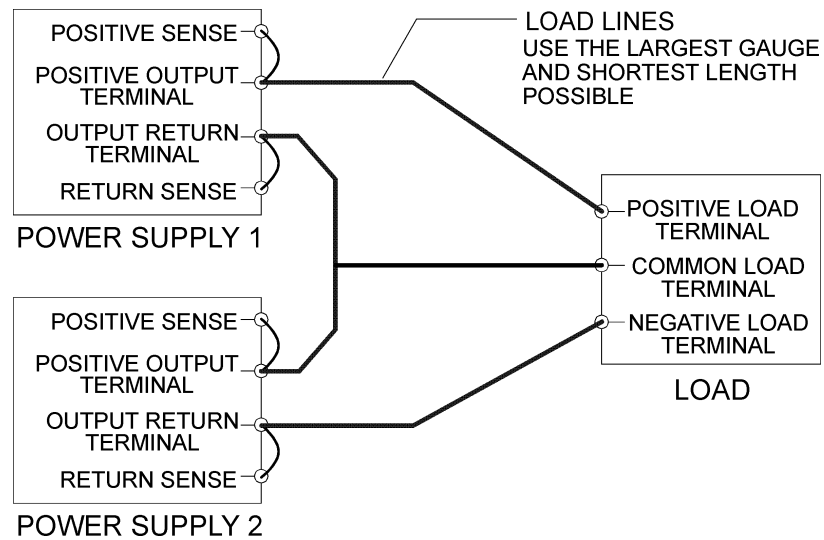

**Figure 4-25 Split Supply Operation of Multiple Supplies (Positive-Negative Supply)**  
*(Local sense lines shown are default J3 connections.)*

## 4.8 OUTPUT VOLTAGE BIASING

The power supply output may be biased up to a maximum of 400 Vdc with respect to the chassis.



**WARNING!** Use extreme caution when biasing the output relative to the chassis due to potential high voltage levels at the output and J3 terminals.

This page intentionally left blank.

# SECTION 5

## THEORY OF OPERATION

### 5.1 INTRODUCTION

This section describes the internal operation of the DCS-E (3kW) Series power supply.

**Section 5.2 Basic Functional Blocks** provides an explanation of the main functions within each functional block of the supply. **Section 5.3 Detailed Circuit Descriptions** contains more in-depth descriptions of the supply's circuitry, including remote programming and monitoring circuits not covered in Section 5.2.

The **Detailed Circuit Descriptions** are intended as a reference for when you are configuring new applications or for when you are troubleshooting. They assume that you are familiar with the operation of logic gates and with the functioning of active and passive components such as op amps, transistors, resistors, capacitors, diodes, transformers, and inductors.

### 5.2 BASIC FUNCTIONAL BLOCKS

The DCS-E (3kW) Series supply is a single isolated output, switch mode power supply which utilizes a 30 kHz pulse width-modulated, full bridge converter. The supply is composed of seven (7) main functional blocks:

1. AC Input and RFI Filter (A5 PCB)
2. AC Input Rectifier and Inrush Limiting Circuit (A6 PCB)
3. PWM (Pulse Width Modulator), Sync Circuit, Power Transformer Drive Circuit, and Power Transistor Bridge (A3 PCB)
4. Power Transformer, Output Rectifiers, Output Inductor, Output Filter Capacitors, and Sense Connections (Power Stage Assembly, A7 PCB, and A8 PCB)
5. Output Current Shunt, Shunt Amplifier, and Down Programmer Circuits (A4 PCB)
6. Control, Programming, OVP, Shutdown, Monitoring, and Auxiliary Supply Circuits (A2 PCB)
7. Front Panel Displays and Local Controls (A1 PCB)

### 5.2.1 AC Input and RFI Filter (A5 PCB)

The AC input, either single or three phase, is connected to the power supply via a four-pole connector on the rear panel and passes through an RFI filter before going to the front panel circuit breaker. The RFI filter serves two purposes:

- It attenuates incoming noise on the AC input lines that could otherwise be passed through to the load.
- It prevents noise generated by the supply from being conducted back onto the AC supply lines where it might interfere with the operation of other equipment connected to that line.

### 5.2.2 AC Input Rectifier and Inrush Limiting Circuit (A6 PCB)

From the front panel circuit breaker, the AC input goes to the A6 PCB where it is rectified and filtered to provide the raw high voltage DC supply for the main power transformer and the auxiliary supply circuit on the A2 Control PCB. An inrush limiting circuit, consisting of a resistor and a relay, limits the initial current to the main filter capacitor during power up.

### 5.2.3 PWM, Sync and Power Transformer Drive Circuit (A3 PCB)

The Pulse Width Modulator (PWM) circuit controls the main switching transistors through a drive circuit and a drive transformer. The main switching transistors chop the raw, high voltage DC supplied by the A6 PCB into a variable-duty cycle 30 kHz waveform which is applied to the primary winding of the power transformer. Feedback signals from the A2 PCB voltage and current control circuits and a current sense transformer which monitors the current in the primary winding of the power transformer control the PWM output pulse width. An optically-coupled sync signal from the A2 PCB drives a phase-locked loop which synchronizes the switching frequency of the A3 PWM and the auxiliary supply circuit to provide noise immunity for the PWM.

### 5.2.4 Power Transformer, Output Rectifiers, Output Filter Inductor and Capacitors, and Local Sense Connections (Power Stage, A7 PCB and A8 PCB)

The switching waveform applied to the primary of the power transformer by the PWM circuit produces a square wave on the secondary windings of the transformer. The secondary waveform is rectified and then filtered by the output inductor and capacitors to provide the DC output. Sense connections on the A7 PCB monitor the output voltage and provide a feedback signal to the A2 PCB voltage control circuit.

### 5.2.5 Output Current Shunt, Shunt Amplifier, and Down Programmer (A4 PCB)

A shunt in the power supply return line is used to monitor the output current. The shunt voltage is scaled and conditioned by a differential amplifier to provide a feedback signal to the A2 PCB current control circuit. A down programming circuit and a preload resistor allow the supply to regulate the output under no load or lightly loaded conditions. The down programming circuit is



also used to discharge the output capacitors whenever the control circuit signal goes negative or when any of the shutdown circuits are activated.

### 5.2.6 Control, Programming, OVP, Shutdown, Monitoring, and Auxiliary Supply Circuits (A2 PCB)

The A2 Control PCB consists of the following circuits:

1. Auxiliary supply circuit
2. Voltage and current control circuits
3. Thermal sense, fan control, and thermal shutdown circuits
4. Over Voltage Protection (OVP) circuit
5. Remote shutdown circuit
6. Remote programming, monitoring, and sense protection circuits

The **auxiliary supply circuit** uses the high voltage DC supply from the A6 Rectifier PCB in a multiple output flyback-type switching supply to generate the +28V, +15V, -15V, +5V, -6.2V, and +5V REFERENCE voltages required by the various control circuits.

The **voltage and current control circuits** monitor the output voltage and current feedback signals, compare them to a reference signal from the front panel controls or remote programming circuit, and provide a control signal for the A3 PCB PWM circuit.

**Thermal sensors** monitor the temperature of the input rectifier heatsink, the main switching transistor heatsink and the output rectifier heatsink to provide an input signal for the fan speed controller circuit and thermal shut down circuit.

An **Over Voltage Protection (OVP) circuit** monitors the output voltage and shuts down the supply whenever a user selected voltage is exceeded.

An optically-isolated **remote shutdown circuit** allows the use of remote AC, DC, or TTL compatible signals to disable the supply's output. The remote shutdown circuit activates an internal shutdown/soft start circuit which:

- pulls the voltage control circuit reference to zero,
- activates the PWM shutdown, and
- activates the down programming circuit.

This internal shutdown circuit is also used by the thermal shutdown, OVP, sense line protection, and PWM sync circuits, and the front panel standby switch to disable the output of the supply whenever any of these circuits are activated.

The A2 PCB also provides access to **remote programming, monitoring, and sense circuits** via a rear panel DSUB connector J3. Remote programming circuits are provided for:

- Output voltage
- Output current limit
- OVP trip point

Monitor signals are available for:

- Output voltage (calibrated)
- Output current (calibrated)
- Operating mode
- Thermal shutdown
- OVP status
- Local/remote programming status

### 5.2.7 Front Panel Displays and Local Operating Mode Controls (A1 PCB)

In addition to providing the output voltage and current displays, the front panel has the local controls for:

- Output voltage
- Output current limit
- OVP set point
- Output standby (locally-controlled shutdown)
- Remote/local programming selection

## 5.3 DETAILED CIRCUIT DESCRIPTIONS

Refer to **Section 7 Assembly Schematics** for links to the Elgar website to access illustrations of the following assemblies:

1. AC Input and RFI Filter Circuit (A5 PCB)
2. Input Rectifier and Inrush Limiting Circuit (A6 PCB)
3. PWM, Sync Circuit, Power Transformer Drive Circuit, and Power Transistor Bridge (A3 PCB)
4. Power Transformer, Output Rectifiers, Output Filter Inductor and Capacitors, and Down Programmer Circuit (A4 PCB, A7 PCB, A8 PCB, and Power Stage Assembly)
5. Auxiliary Supply, Voltage and Current Control, Programming, and Monitor Circuits (A2 PCB)
6. Front Panel Displays and Controls (A1 PCB)

**Note:** When several like components with similar functions are referred to in the circuit descriptions in this section, a hyphenated numeric format has been used to shorten the list. For example, C1-3 denotes capacitors numbered 1 through 3, inclusive.

### 5.3.1 AC Input and RFI Filter Circuit (A5 PCB)

The AC input is connected to the power supply via a four-pole connector in the rear panel. For three phase operation, three (3) phase lines, X, Y, and Z (190-250 Vac at 14A), and a safety ground line are required. For single phase operation, two (2) phase lines (200-250 Vac at 20A), and a safety ground line are required. Single phase input lines are connected to the X and Z inputs of the connector so that each line is connected to a separate rectifier on the A6 PCB. For continuous use with single phase inputs, the output power from the supply must be limited to 2500W to avoid tripping the input circuit breaker. The safety ground connection for both single and three phase operation is essential both to ensure that there is no shock hazard present and to ensure proper operation of the RFI filter and other bypass circuits.

The RFI filter, used to attenuate both common mode and differential mode noise, is an LC filter formed by X (line-to-line) capacitors C1-3 and C7-9, inductor L1, Y (line-to-ground) capacitors C4-6, and resistors R1-3 which serve as discharge resistors for the X capacitors.

### 5.3.2 Input Rectifier and Inrush Limiting Circuit (A6 PCB)

The AC input is rectified by the heatsink-mounted rectifiers CR2 and CR2A and then filtered by inductor L1 and capacitor C2 to provide the raw high voltage DC (approximately 250-350V) for the main switching transistors and the A2 PCB auxiliary supply circuit. Resistor R2 provides a discharge path for the bulk capacitor C2 on power down. Capacitors C1, C3, and C4 provide noise filtering. The initial power up inrush current to capacitor C2 is limited by resistors R1. When the DC voltage reaches approximately 240V, the coil of relay K1 is energized by the auxiliary supply circuit on the A2 PCB and the inrush resistor is shorted by the relay contacts. Input current then flows through the relay contacts.

### 5.3.3 PWM, Sync Circuit, Power Transformer Drive Circuit, and Power Transistor Bridge (A3 PCB)

The A3 PCB consists of a PWM circuit, a sync circuit, a power transistor drive circuit, and a power transistor bridge.

**Pulse width modulator (PWM) U1** is a fixed-frequency current mode controller which drives the main switching transistors Q8-Q11 through drive transistors Q2-Q7 and transformer T1. The PWM varies its output pulse width (and therefore the ON time of the power transistors and the power supply output) in response to feedback signals from the A2 PCB voltage and current control circuits, and current sense transformer T2 which monitors the current in the primary of the power transformer.

The PWM consists of six (6) main blocks: an error amplifier, a current sense amplifier, a comparator circuit, an oscillator circuit, a 5.1V REFERENCE circuit, and an output stage.

The error amplifier monitors the feedback signal from the A2 PCB voltage and current control circuits at pin 5 of U1 and provides a reference for the PWM comparator inverting input. A current limit signal at pin 1 of U1, derived by resistors R1 and R2 from the PWM 5.1V REFERENCE, limits the maximum output swing of the error amplifier thereby setting a maximum limit for the primary current in the power transformer.

The current sense amplifier monitors the current in the primary winding of the power transformer using transformer T2 and provides the signal to the non-inverting input of the PWM comparator.

Diodes CR14 and CR15 rectify the output from T2 and resistors R3 and R11-3 scale the signal before it is input to the positive input of the current sense amplifier at pin 4 of U1. Slope compensation for PWM output duty cycles above 50% is obtained by injecting the timing capacitor ramp into the same input through transistor Q1, capacitor C3, and resistors R4 and R9.

The comparator circuit monitors the PWM error and current sense amplifier outputs and terminates the PWM output pulse when the current amplifier output signal reaches the error amplifier reference level. The oscillator circuit provides the 60 kHz timing signals for the PWM.

The **sync circuit** is used to synchronize the switching frequency of the A3 PWM to that of the A2 auxiliary supply to reduce noise related switching problems. The circuit consists of phase-locked loop (PLL) U2 and its related components. An optically-coupled sync signal (approximately 60 kHz) from the A2 auxiliary circuit oscillator is applied to one input of the PLL phase comparator at pin 3. The other input, at pin 14, comes from the A3 PWM oscillator timing capacitor (C7) via capacitor C8. The output of the phase comparator (at U2, pin 2) is connected to the PWM oscillator timing resistor R14 via resistor R18 and the low pass filter formed by R19 and capacitor C15. The comparator output controls the charging rate of the PWM timing capacitor, thereby synchronizing the two signals. The PLL also serves to shut down the PWM whenever the sync signal from the A2 PCB is absent by applying a high signal from U2 pin 10 through diode CR2 to the shutdown input of the PWM at pin 16. Whenever the sync signal is present, the shutdown signal is inhibited by the high signal at pin 5 of U2.

The gate drive signal for the main switching transistors is supplied by **drive transformer T1**. The primary of T1 is driven by the output from PWM at pins 11 and 14 through FETs Q2-7. In addition to providing the required drive signals, transformer T1, along with the main power transformer, current feedback transformer T2, and optocoupler U15 on the A2 PCB, provide the isolation between the power supply input and output.

The primary of the power transformer is driven by the main switching transistors, Q8-11 IGBTs (insulated gate bipolar transistors) which are configured as a **full bridge**. The power transistors are switched ON and OFF in pairs by drive transformer T1, with Q8 and Q10 forming one pair and Q9 and Q11 the other pair. This paired switching action reverses the polarity of the signal applied to the transformer primary to produce a 30 kHz AC waveform on its input. Capacitor C25 and resistor R35 form a snubber across the power transformer primary winding. Each power transistor has a collector-to-emitter snubber consisting of a resistor, a diode, and a capacitor.

#### 5.3.4 Power Transformer, Output Rectifiers, Output Filter Inductor and Capacitor, and Down Programmer Circuit (A4 PCB, A7 PCB, A8 PCB, and Power Stage Assembly)

The output of the power transformer is rectified using one of two rectifier output configurations:

- Full wave center tap (8 to 80V models), or
- Full wave bridge (150V model)

RC snubbers across each rectifier (also across the entire secondary of the transformer on some models) and tape-wound toroids on each transformer secondary lead are used to suppress transients. The rectifier output is filtered by capacitors C701-711 on the A7 PCB, capacitors

C801-803 on the A8 PCB, and the output inductor to provide the DC output. Energy stored in the output capacitors and the input bulk capacitor provide the holdup time of the supply.

A blade-type current shunt (R19) attached to the A4 PCB is used to monitor the output current and provide a feedback signal to the A2 PCB current control circuit. Op amp U2 is a differential amplifier used to condition and scale the shunt voltage to produce a 0-5V signal.

Output voltage regulation under no load or lightly loaded conditions is made possible by preload resistor R701 and the down programming circuit (op amp U1, FET Q1 and their related parts) which draw a small current whenever there is an output voltage. The down programming circuit also serves to quickly discharge the output capacitors when changes in programming inputs require a lower output voltage from the supply. The down programming circuit monitors the control signal from the A2 PCB voltage and current control circuits at pin 6 of U1-B. Whenever this signal becomes more negative than the reference at pin 5 (approximately -0.125 Vdc), the output of U1-B goes positive and FET Q1 is turned on by U1-A through resistor R4. Resistor R1 acts as a current shunt for the down programmer to provide feedback to U1-A pin 2 to maintain a constant current through Q1. Resistor R9 and diode CR4 feedback the current shunt amplifier output to U1-A to reduce the current drawn through Q1 when the load current provides a discharge path for the output capacitors.

### 5.3.5 Auxiliary Supply, OVP, Control, Programming, Monitor Circuit (A2 PCB)

The A2 Control PCB consists of the following circuits:

1. Auxiliary supply circuit
2. Inrush limit control, input over-voltage shut down, and sync circuits
3. Voltage control, current control, mode indicator, and internal shutdown/soft start circuits
4. Remote/local programming select circuits
5. Remote analog programming input circuits
6. Remote sense line protection circuit
7. Over Voltage Protection (OVP) circuit
8. Remote shutdown circuit and front panel standby switch
9. Output voltage and current readback circuits
10. Fan control and over-temperature shutdown circuit

#### **AUXILIARY SUPPLY CIRCUIT**

The auxiliary supply circuit is a multiple output, flyback converter used to generate the +28V, +15V, -15V, +5V, -6.2V, and +5V REFERENCE voltages required by the various control circuits. The main components of the auxiliary supply are oscillator U17, PWM U16, and transformer T1. Oscillator U17 is a CMOS 555 timer which generates a 60 kHz signal for the PWM and the sync circuits. PWM U16 produces a 60 kHz variable pulse width output which drives FET Q7. Q7 switches the primary winding of transformer T1. Current and voltage feedback signals to the PWM control its output pulse width, thereby regulating the auxiliary output voltages. Current feedback to the PWM is provided by shunt resistor R114 which monitors current in the transformer primary winding. Resistors R115, R122, and capacitor C60 scale and condition the

signal before inputting it to the PWM current sense comparator at pin 3. A primary side, flyback winding on T1 and diode CR39 provides the voltage feedback signal for the PWM as well as its raw supply power. Resistors R121 and R131 scale the voltage feedback signal before it is input to the inverting side of the PWM error amplifier at pin 2. The output of the error amplifier is input to the current sense comparator which controls the PWM output pulse width. Four secondary windings on transformer T1 are diode-rectified and filtered to provide +28V, +15V, -15V and +5V outputs. The +5V REFERENCE is derived from the +15V supply by reference IC U1. The -6.2V output is derived from the -15V supply by zener diode CR4. Diodes CR31 and CR32, resistors R107 and R108, and capacitors C45 and C46 form snubbers on the primary of T1 to limit transients. Resistor R130 and capacitor C61 are compensation components for the error amplifier. Diode CR38 provides a +18V supply voltage for the inrush limiting and over-voltage shutdown circuits.

### **INRUSH LIMIT CONTROL, INPUT OVER-VOLTAGE SHUTDOWN, AND SYNC CIRCUITS**

The inrush limit control circuit monitors the high voltage DC supply and holds the A3 PCB PWM and the A6 PCB inrush relay K1 OFF until the raw supply reaches approximately 240 Vdc. The circuit is formed by op amp U14-B, transistors Q8 and Q9, and their related components. On initial power up, the output of U14-B is held low by a 5V reference signal on pin 6. As the raw supply voltage increases, the voltage on pin 5 increases until, at a raw supply voltage of approximately 240 Vdc, the voltage at pin 5 exceeds the reference voltage and the output of U14-B goes high. This turns ON transistors Q8 and Q9. Q8 energizes the coil of relay K1 on the A6 PCB which closes the relay contacts and shorts out the inrush limiting resistors R1/R1A. Transistor Q9 turns on optocoupler U15 which enables the sync signal to the A3 PCB and allows the A3 PWM to start.

Input over-voltage shutdown is provided by op amp U14-A. U14-A monitors the raw supply voltage at pin 2 through the voltage divider formed by resistors R109 and R110. When the raw supply reaches approximately 410V, the voltage at pin 2 exceeds the 5V reference at pin 3 and the output of U14-A goes low. This pulls the inverting input of U14-B low through diode CR37 and causes the output of U14-B to go low. This turns OFF transistor Q9 which disables the sync signal to the A3 PWM and activates its shutdown circuit.

### **VOLTAGE CONTROL, CURRENT CONTROL, MODE INDICATOR, AND INTERNAL SHUTDOWN/SOFT START CIRCUITS**

The voltage and current control circuits monitor the output voltage and current from the supply and provide a feedback signal for the A3 PCB PWM and the A4 PCB down programming circuits.

The **voltage control circuit** consists of op amp U3-D and its related components. The output voltage of the supply is monitored at the inverting input of U3-D (pin 13) through the positive sense line and the voltage divider formed by resistors R6, R7, R44, and R43. A 0-5V reference signal at the non-inverting input (pin 12) comes from one of three sources, depending on which programming mode has been selected. In local programming mode, the reference signal comes from the front panel voltage control through analog gate U4-C. When remote analog programming is enabled, the input signal is routed through analog gate U4-B. When the optional IEEE-488 programming card is enabled, the reference signal is routed to the reference input through resistor R78. Resistor R10 and capacitors C7 and C8 are compensation components for U3-D.

The **current control circuit** consists of op amp U3-C and its related components. Operation of the current control circuit is similar to that of the voltage control circuit. The 0-5V output current feedback signal from the A4 shunt amplifier is monitored at the inverting input of U3-C (pin 9). The 0-5V reference signal, from either the front panel control (via analog gate U3-D), a remote analog programming source (via analog gate U3-A), or an IEEE-488 programming card (via resistor R77), is monitored at the non-inverting input (pin 10).

Resistor R45 and diode CR17 "OR" the output of the voltage and current control circuits to derive the A3 PWM and A4 down programming control signal. During voltage mode operation, the output of the current control circuit remains high and the output of op amp U3-D provides the control signal through diode CR17. During current mode operation, the output of the voltage control circuit is high, diode CR17 is reverse-biased, and the output of op amp U3-C supplies the control signal through resistor R45. The control signal regulates the output of the supply by providing negative feedback to the A3 PCB PWM error amplifier. For example, if the power supply output voltage or current attempts to rise above the selected level:

- the control signal from the voltage and current control circuits decreases and
- causes the output of the PWM error amplifier to decrease, which
- reduces the output pulse width from the PWM, and
- reduces the voltage and current output to the selected level.

A complementary reaction occurs if the power supply output attempts to fall below the selected output. The control signal, error amplifier, and PWM output pulse width all increase to raise the output to the selected value.

Op amp U3-B monitors the voltage across diode CR17 to control the voltage and current **mode indicator** LEDs on the front panel of the supply. When the supply is operating in voltage mode, diode CR17 is forward-biased, the output of U3-B is high, and the voltage mode LED is illuminated. When the supply is operating in current mode, diode CR17 is reverse-biased, the output of U3-B is low, and the current mode LED is illuminated. In addition to controlling the front panel mode LEDs, op amp U3-B also provides an analog remote monitoring signal at J3 connector pin 5 and a readback signal for the optional IEEE-488 card at pin 6 of connector P2.

The **internal shutdown/soft start circuit** is made up of MOSFET Q1, capacitor C3, diode CR3, and resistors R2 and R3. The circuit is activated by the remote shut down, OVP, over-temperature shutdown, and sense line protection circuits, as well as by the front panel standby switch. When any of these circuits are activated, a high signal is applied through diode CR3 to charge capacitor C3 and turn ON Q1. This clamps the reference input for the voltage control circuit at pin 12 of U3-D to ground and causes the output of the supply to fall to zero. When the shutdown condition is removed, capacitor C3 discharges through resistors R2 and R3 and the voltage control reference at pin 12 makes a controlled rise.

### REMOTE/LOCAL PROGRAMMING SELECT CIRCUITS

These circuits select the source of the voltage and current control circuit reference signals. The reference signals are provided by one of three sources:

- Front panel controls (local programming mode)
- Remote analog programming sources
- Optional IEEE-488 programming card

**Note:** When installed and enabled, the optional IEEE-488 card has the highest priority as a programming source and will override the selection of either local control or remote analog programming.

In both the voltage and current control circuits, selection of the reference signal source is controlled by two CMOS switches and a pair of associated logic gates. Switching between local programming mode and remote analog programming can be accomplished using either the front panel REM/LOC switch or the rear panel J3 connector. The front panel REM/LOC switch can be used whenever operations involve programming of BOTH the output voltage AND current limit using remote voltage sources (0-5V or 0-10V) or current sources (0-1 mA). Use of the REM/LOC switch allows the operator to switch back and forth between local and remote analog programming without changing any of the default J3 connections. In applications requiring the use of resistive programming, or where programming of the output voltage AND/OR the output current limit is necessary, the J3 connector must be used to select the programming source.

In the voltage control circuit, analog switches U4-C and U4-B select which of the three programming sources is enabled according to the following table.

Programming Source Enabled	Switch U4-C	Switch U4-B	IEEE-488 Enable (Pin P2-4)
Local programming	ON	OFF	HIGH
Remote analog programming	OFF	ON	HIGH
IEEE-488 programming	OFF	OFF	LOW

The analog gates are controlled by logic gates U5-D and U5-A. In local programming mode, both inputs to U5-D are high and its output is low. Pin 12 of U5-D is held high by the J3 connector jumper connecting the 1 mA current source at pin 21 to resistor R73 while pin 13 is held high by a +15V signal through resistors R74-R76. The low output of U5-D turns ON gate U4-C, connecting the front panel control signal to the voltage control op amp U3-D, and turns gate U4-B OFF by causing the output of U5-A to go high.

When remote analog programming is selected using the front panel REM/LOC switch, pin 13 of U5-D is pulled low through diode CR12, causing the output of U5-D to go high. This shuts OFF gate U4-C and causes the output of U5-A to go low which turns ON gate U4-B, connecting the remote programming signal to the voltage control circuit.

When analog programming is selected using the J3 connector, the jumper connecting pins 21 and 20 is removed, disconnecting the 1 mA current source from resistor R73. Pin 12 of U5 D is then pulled low through resistors R72 and R73, causing the output of U5-D to go high. This turns gate U4-C OFF and gate U4-B ON, connecting the remote programming signal to U3-D.

Selection of IEEE-488 programming occurs when the IEEE card pulls pin 13 of U5-D and pin 2 of U5-A low through connector P2, pin 4. This causes the output of both U5-D and U5-A to go high and switch OFF both U4-C and U4-B. The IEEE programming signal is then input to the voltage control op amp through resistor R78.

Operation of the current control circuit is the same as the voltage control circuit with CMOS switches U4-D and U4-A and NAND gates U5-B and U5-C providing the required functions.

The operation of the front panel remote indicator LED and the J3 remote programming indicator signal is controlled by transistor Q2. Whenever either remote analog or IEEE-488 programming is selected, the output of U5-D and/or U5-C is high. This high signal is input to the base of



transistor Q2 through diodes CR13 and/or CR14, turning ON the transistor, and activating the LED and the monitor signal.

### REMOTE ANALOG PROGRAMMING INPUT CIRCUITS

These circuits are used to buffer, scale, and calibrate the remote analog programming signals before they are input to the voltage and current control circuits. Op amp U10 and its related components condition the signal to the voltage control circuit. Input to the circuit is through pin 9 of the rear panel J3 connector. Diodes CR26 and CR27 clamp any out-of-range or reverse polarity inputs. Trimpot R93 is used to null any offset voltage from U10. Trimpot R60 is used to calibrate the signal. For programming with remote voltage sources, jumper JMP1 is used to select either 0-5V or 0-10V input scales. For remote programming with 0-1 mA current sources, resistor R41 generates the required 0-5V signal from the programming source. For remote programming with 0-5k ohm resistances, the 1 mA current source provide by op amp U13-B generates the required 0-5V signal. U13-B and its related parts produce a regulated 1 mA output by maintaining a fixed 2.5V drop across resistor R97 through transistor Q5.

Operation of the current programming input circuit is the same as the voltage circuit, with op amps U11 and U13-A and their related components performing the required functions.

### REMOTE SENSE LINE PROTECTION CIRCUIT

The remote sense line protection circuit shuts down the power supply output in the event that:

- the sense line connections are reversed,  
or
- the positive or negative output load lines become disconnected, with the remote sense lines connected.

The circuits consists of relays K1 (positive sense) and K2 (negative sense) and diodes CR1 and CR2. When either of the fault conditions occur, current flows through the relay coils and activates the relay contacts. This connects +15V to the internal shutdown circuit to disable the output of the supply. Diodes CR1 and CR2 limit the voltage across the relay coils for reverse polarity conditions.

## OVER VOLTAGE PROTECTION (OVP) CIRCUIT

The OVP circuit protects the load connected to the power supply from over-voltage conditions arising from programming errors, incorrect voltage control adjustments, or power supply failure. The OVP circuit monitors the output voltage and activates the internal shutdown circuit of the supply whenever the output exceeds a selected trip limit. Op amp U7-A monitors the output voltage of the supply at pin 3 through the divider formed by resistors R1 and R84. When the voltage at pin 3 rises above the trip point reference at pin 2, the output of U7-A goes high activating the internal shutdown circuit through diode CR20. Resistor R82 and diode CR22 latch the OVP circuit ON after it has been activated. Resetting of the circuit (after correcting the cause of the original activation) is accomplished by cycling the power supply OFF and then ON to release the latch. It can also be reset by using the front panel standby switch or by activating the remote shutdown function. Using standby or remote shutdown will also reset the OVP by pulling reference pin 2 high through diode CR21.

The 0-5V reference trip limit, at pin 2 of U7-A, can be set using the front panel potentiometer, using 0-5V or 0-10V analog remote programming signals, or through the optional IEEE-488 programming card. Switch SW1-7 is used to select either local (switch CLOSED) or remote (switch OPEN) programming. With SW1-7 CLOSED and SW1-6 OPEN, the trip level is set by the front panel OVP potentiometer. To use remote analog programming, switch SW1-7 is set to OPEN, disconnecting the front panel input, and the programming source is connected to J3 connector pin 3. Switch SW1-6 is used to select the programming scale: 0-5V with the switch OPEN or 0-10V with the switch CLOSED.

## REMOTE SHUTDOWN CIRCUIT AND THE FRONT PANEL STANDBY SWITCH

The remote shutdown circuit and the front panel standby switch are used to disable the output of the supply without shutting off the entire supply. The function can be used when making changes to either the load or to power supply settings or as part of remote startup/safety interlock circuits. The standby switch and the remote shutdown function can also be used to reset the OVP circuit after it has been activated. The remote shutdown circuit accepts 12-250 Vac, 12-130 Vdc, or TTL compatible inputs, while the front panel standby switch provides local access to the shutdown circuit.

The **remote shutdown circuit** is made up of optocoupler U9, NAND gates U8-A and U8-B, switch SW1-8, transistor Q6, and their related components. Switch SW1-8 is used to select either positive or negative logic for the remote input signal. With the switch OPEN, the circuit uses positive logic so that a high input disables the output of the supply. With the switch CLOSED, the circuit uses negative logic so that a low input disables the output. Optocoupler U9 isolates the programming input from the supply, allowing the use of programming sources with a voltage differential of up to 400 Vdc with respect to the output. NAND gates U8-A and U8-B provide the required logic for the various inputs. The output of U8-B controls transistor Q6 which activates the internal shutdown circuit of the supply through diode CR19 when it is ON. The high signal which activates the shutdown circuit also illuminates the front panel shutdown (S/D) LED through pin 14 of connector J1. Resistor R101 provides the IEEE-488 monitor signal. Diode CR24 rectifies AC inputs to the optocoupler. Diode CR25 protects against reverse polarity TTL signals.

The **front panel standby switch** shuts down the supply by putting a high signal on the S/D LED line which activates the internal shutdown circuit through diode CR19 and turns the front panel indicator LED ON.

### OUTPUT VOLTAGE AND CURRENT READBACK CIRCUITS

These circuits provide calibrated, switch-selectable 0-5V or 0-10V analog readback signals for remote monitoring of the output voltage and current. The output voltage readback signal is available at pin 19 of the rear panel J3 connector and the current readback signal is available at pin 7.

The **voltage readback circuit** is made up of op amp U6, switch SW1-4, calibration pots R55 and R56, and resistors R52, R53, R54, and R57. The op amp monitors the output voltage of the supply through the positive sense divider formed by resistors R6, R7, R44, and R43. For 0-5V readback, switch SW1-4 is CLOSED and resistors R53, R54, R57, and trimpot R56 scale and calibrate the monitor signal. Trimpot R55 is used to null any output offset. For a 0-10V readback signal, switch SW1-4 is OPEN, removing resistor R53 from the scaling resistors.

Operation of the **current readback circuit** is the same as the voltage readback circuit. The circuit is made up of op amp U2, switch SW1-3, calibration pots R23 and R24, and resistors R19, R20, R21, and R25. The input to the op amp is from the current shunt amplifier through the divider formed by resistors R22 and R26.

### OVER-TEMPERATURE SHUTDOWN CIRCUIT

The **over-temperature shutdown circuit** monitors the temperature of the A6 PCB input rectifier heatsink, the A3 PWM heatsink, and the output rectifier heatsink, using thermal sensors RT1, RT2, and RT3 respectively.

When the heatsink temperature reaches approximately 100°C, the output of U7-B goes negative, causing the output of U7-D to go high. This activates the **internal shutdown** circuit and the PWM shutdown lines through diodes CR16 and CR15. The front panel OTP (over-temperature protection) LED is illuminated through resistor R28. The J3 remote monitor line is fed by resistor R18. The IEEE-488 monitor line is activated through pin 5 of connector P2.

### 5.3.6 Front Panel Displays and Controls (A1 PCB)

The A1 front panel PCB consists of:

- Output voltage and current displays
- Local controls for output voltage and current limit
- Local control potentiometer for the OVP set point
- Switches for:
  - previewing local voltage and current limit control settings (SW3 V & I CHECK)
  - previewing local OVP set point (SW4 OVP CHECK)
  - selecting remote or local control (SW1 REM/LOC)
  - activating output standby circuit (SW2 STANDBY)
  - LED indicators for operating mode, over-temperature, remote programming operation, shutdown, and OVP
  - IEEE-488 Option connector P2 and LED indicators for ADDRESSED, SERVICE REQUEST, SYSTEM FAULT, FOLD, ERROR, FAULT, POLARITY, and ISOLATION

#### OUTPUT VOLTAGE AND CURRENT DISPLAYS

The voltage and current displays are made up of three or four (depending on the model) seven-segment LED displays (DS1-DS8) driven by 3 1/2-digit analog to digital (A/D) converters (U1 and U2). In both the voltage and current display circuits, an analog signal from the A2 PCB voltage and current control circuits is compared to a reference voltage on the A/D to generate the digital output for the seven-segment displays. The A/D conversions are done and the displays updated approximately three times per second.

In the **voltage display circuit**, the 5V reference from the A2 PCB is divided down by resistors R15, R16, and calibration potentiometer R17 to provide a 1V reference for U2 at pin 36. The analog input from the voltage control circuit (via connector P1, pin 6) is filtered by resistor R9 and capacitor C15 before being input to pin 31 of U2. Resistor R7 and capacitor C13 set the conversion frequency. Capacitors C14, C16, and C17 with resistor R10 are used by the A/D in its reference integration, auto zero, and input signal integration circuits. Resistors R8, R18, and R19 are used to select the appropriate decimal point position for displays DS6-DS8.

The **current display circuit** operates similarly to the voltage circuit. Resistors R11-R14 form the reference divider. The analog input from the current control circuit via P1-8 is filtered by R3 and C5. R2 and C2 set the conversion frequency. Capacitors C4, C6, C7, and R4 are the integration and auto zero components. R1, R5, and R6 select the appropriate decimal point.

#### LOCAL OUTPUT VOLTAGE AND CURRENT LIMIT CONTROLS

The local controls for voltage and current limit are ten-turn potentiometers (R27 and R20 respectively) which provide a 0-5V reference to the voltage and current control circuits on the A2 PCB.

### LOCAL OVP SET POINT CONTROL

Potentiometer R29 (or R29A depending on the production part used) is a 20-turn trimpot which provides a 0-5V reference signal to the OVP circuit on the A2 PCB via pin 17 of connector P1.

### VOLTAGE AND CURRENT (V & I) CONTROL SETTING CHECK SWITCH SW3

The momentary switch SW3 allows the front panel voltage and current controls settings to be previewed on the voltmeter and ammeter displays. When depressed, the switch disconnects the normal meter inputs from the A2 PCB and connects a calibrated signal from the front panel controls to the meter inputs. The resistive divider formed by R24, R25, and R26 scales and calibrates the signal from the voltage control potentiometer R27. Resistors R21-R23 are used to scale and calibrate the signal from the current limit potentiometer R20.

### OVP SET POINT CHECK SWITCH SW4

Similarly to the V & I CHECK switch, momentary switch SW4 allows the front panel OVP potentiometer setting to be displayed on the voltmeter. When depressed, the switch disconnects the normal A2 PCB voltmeter input line and connects a calibrated signal from the OVP potentiometer to the voltmeter. Resistors R30-R32 are used to scale and calibrate the OVP control signal.

### REMOTE/LOCAL SWITCH SW1

This press ON/press OFF switch activates both the voltage and current remote programming selector circuits on the A2 PCB via P1 connector pin 19. See **Section 5.3.5** for a description of the programming mode selector circuit.

### OUTPUT STANDBY SWITCH SW2

This press ON/press OFF switch shuts off the power supply output so that load and/or programming changes can be made without shutting off the AC input to the supply. The switch activates the A2 PCB internal shutdown circuit through pin 14 of connector P1. See **Section 5.3.5** for a description of the internal shutdown circuit operation.

### INDICATOR LEDs

The indicator LEDs for voltage mode operation, current mode operation, over-temperature shutdown, remote programming operation, shutdown, and OVP circuit activation are located on the A1 PCB. See **Section 5.3.5** for a description of how the related circuits operate.

### IEEE-488 OPTION P2 CONNECTOR SIGNALS AND INDICATOR LEDs

Connector P2 provides the connection to the optional IEEE-488 digital programming, readback, and monitoring PCB. Eight LED indicators for ADDRESSED, SERVICE REQUEST, SYSTEM FAULT, FOLD, ERROR, FAULT, POLARITY, and ISOLATION conditions with their common ground are connected to pins 1-9. Pin 10 provides the option board with a signal to indicate the status of the Remote/Local switch SW1 on the front panel. Pin 11 provides a signal to the option board whenever either the front panel standby switch or the A2 remote shutdown circuit are activated.

This page intentionally left blank.

# SECTION 6 MAINTENANCE

## 6.1 INTRODUCTION

This section provides general maintenance and calibration information as well as replacement parts lists for the DCS-E Series (3kW) supply.

### 6.1.1 Units Under Warranty

Units requiring repair during their warranty period should be returned to the manufacturer for service. Unauthorized repairs performed by any one other than the manufacturer during the warranty period may void the warranty. Any questions regarding the warranty or any repairs should be directed to the manufacturer.

 <b>WARNING!</b>	Exercise caution when using and servicing power supplies. High energy levels can be stored at the output voltage terminals on all power supplies in normal operation. In addition, potentially lethal voltages exist in the power circuit and the output connector of power supplies that are rated at 40V and over. Filter capacitors store potentially dangerous energy for some time after power is removed.
--	---

## 6.2 GENERAL SERVICE AND REPAIR

### 6.2.1 Periodic Maintenance

Routine service consists only of annual calibration and periodic cleaning. Whenever a unit is removed from operation, clean it with naphtha or an equivalent solvent for the metal surfaces and with a weak solution of soap and water for the front panel. Use low pressure compressed air to blow dust from in and around components on the printed circuit boards.

### 6.2.2 Servicing Precautions

Always disconnect power, discharge circuits, and remove external voltage sources before making internal adjustments or replacing components. When performing internal adjustments or servicing the power supply, ensure another person with first aid and resuscitation certification is present. Repairs must be made by experienced technical personnel only.

Be sure to isolate the power supply from the input line with an isolation transformer when using grounded test equipment, such as an oscilloscope, in the power circuit.

### 6.2.3 Parts Replacement and Repairs

Parts lists are in **Section 6.4 Replaceable Parts**. Do not use substitute parts or make any unauthorized modifications to the power supply to ensure that its safety features are not degraded.

### 6.2.4 Unusual or Erratic Operation

If the power supply displays any unusual or erratic operation, follow these steps:

- Shut the power supply off immediately.
- Disconnect it from the AC power source.
- Check all load, programming, and monitoring connections and circuits.
- Check the AC input for correct voltage and frequency.
- Correct any problems found.
- Retest the system. (See **Section 2.6 Initial Functional Tests**.)

If the problem is not solved after following this procedure, or if the unit fails to operate correctly upon retesting, call the manufacturer.

## 6.3 CALIBRATING FOR PROGRAMMING ACCURACY

The offset and range of the voltage and current programming circuits are calibrated for default 0-5 Vdc programming signals at the factory. Recalibration should be performed annually, and may be necessary when you use custom 0-10 Vdc programming or when you switch back to 0-5 Vdc programming after previously calibrating for 0-10 Vdc programming.



**WARNING!**

The calibration procedures are performed with the power supply cover off and the power on. To prevent personal injury, read **Section 2.2 Safety** and follow the procedures for removing and replacing the cover in **Section 4.2.3**. Use a non-conducting, straight blade adjusting tool for regulating the multiturn trim pots.



## 6.3.1 Voltage Programming Circuit Calibration

Designation & Location (Multiturn trim pots)	Voltage Programming Recalibration Procedure
Voltage Program Offset (R93)	<ul style="list-style-type: none"> <li>• Disconnect any load. Connect a DVM rated at better than 0.5% accuracy to the power supply output.</li> <li>• Apply 1% of program voltage (e.g., 0.1 for 0-10Vdc or 0.05 for 0-5Vdc programming source).</li> <li>• Adjust R93 until the DVM reads 1% of the rated output voltage (e.g., 0.6Vdc for Model 60-50).</li> </ul>
Voltage Program Scale (R60)	<ul style="list-style-type: none"> <li>• Disconnect any load. Connect a DVM rated at better than 0.5% accuracy to the power supply output.</li> <li>• Apply 100% of program voltage (e.g., 10V for 0-10Vdc or 5V for 0-5Vdc programming source).</li> <li>• Adjust R60 until the DVM reads 100% of the rated output voltage (e.g., 60Vdc for Model 60-50).</li> </ul>

## 6.3.2 Current Programming Circuit Calibration

Designation & Location (Multiturn trim pots)	Current Programming Recalibration Procedure
Current Program Offset (R95)	<ul style="list-style-type: none"> <li>• Connect a shunt and DVM to the power supply output. See Note 1.</li> <li>• Apply 1% of program voltage (e.g., 0.1 for 0-10Vdc or 0.05 for 0-5Vdc programming source).</li> <li>• Adjust R95 until the DVM indicates 1% of the rated output current (e.g., 0.5A for Model 60-50). See Note 2.</li> </ul>
Current Program Scale (R66)	<ul style="list-style-type: none"> <li>• Connect a shunt and DVM to the power supply output. See Note 1.</li> <li>• Apply 100% of program voltage (e.g., 10V for 0-10Vdc or 5V for 0-5Vdc programming source).</li> <li>• Adjust R66 until the DVM indicates 100% of the rated output current (e.g., 50A for Model 60-50). See Note 2.</li> </ul>

**Notes:**

1. The DC shunt-DVM combination must be rated at better than 0.5% accuracy. The recommended current ratings for the DC shunt and connecting wire must be at least 10% greater than the power supply's output current rating.
2. The required DVM reading is calculated using  $V=I \times R$  where V is the DVM reading, I is the current, and R is the DC shunt resistance.



The calibration procedures are performed with the power supply cover off and the power on. To prevent personal injury, read **Section 2.2 Safety** and follow the procedures for removing and replacing the cover in **Section 4.2.3**. Use a non-conducting, straight blade adjusting tool for regulating the multiturn trim pots.

## 6.4 REPLACEABLE PARTS

In this section, you will find parts lists for the following DCS-E Series (3kW) assemblies:

- Main Assembly
- Front Panel Assembly
- A2 Control Circuit PCB Assembly (includes J3 connector and programming shell)
- A3 Driver, Bridge, and PWM Assembly
- Power Stage (A4, A7, A8)
- A5 AC Input and RFI Filter PCB Assembly
- A6 AC Input Rectifier PCB Assembly
- A9 Ripple Current Reduction PCB Assembly (8V and 12V)
- A10 Rectifier PCB Assembly

Most assemblies consist of parts common to all DCS-E Series (3kW) model assemblies as well as parts that are model-specific, or differential. Each of the parts and assemblies listed, whether complete, common, or differential, can be ordered separately.

### 6.4.1 Parts Replacement and Modifications

Do not use substitute parts or make any unauthorized modifications to the power supply to ensure that its safety features are not degraded. For service and repair help, contact the factory.

### 6.4.2 Ordering Parts

Order parts from the factory using the parts numbers given in the specific assembly parts lists in this section.

**Please include the power supply's model number and serial number with your order.**

## 6.4.3 DCS-E 3kW Parts Lists by Model Number

	DCS 8-350E	DCS 12-250E	DCS 20-150E	DCS 40-75E	DCS 55-55E	DCS 60-50E	DCS 80-37E	DCS 150-20E
<b>Main Assembly</b>	5362295-01	5362295-02	5362295-03	5362295-04	5362295-05	5362295-06	5362295-07	5362295-08
<b>Front Panel (A1)</b>	1065809-008 1068768-008 5360748-BS	1065809-012 1068768-012 5360748-BS	1065809-020 1068768-020 5360748-BS	1065809-040 1068768-040 5360748-BS	1065809-055 1068768-055 5360748-BS	5360748-BS	1065809-080 1068768-080 5360748-BS	1065809-150 1068768-150 5360748-BS
<b>Control (A2)</b>	1068531-008 1068531-1	1068531-012 1068531-1	1068531-020 1068531-1	1068531-040 1068531-1	1068531-055 1068531-1	5362286-07	1068531-080 1068531-1	1068531-150 1068531-1
<b>Driver Bridge PWM (A3)</b>	5360351-03 5360111-01	5360351-02 5360111-01	5360351-02 5360111-01	5360351-02 5360111-01	5360351-02 5360111-01	5362297-01	5360351-02 5360111-01	5360351-02 5360111-01
<b>Power Stage (A4,A7,A8)</b>	1065812-008 1068584-008 1068584-1 1068590-008 1068590-1	1065812-012 1068584-012 1068584-1 1068590-012 1068590-1	1065812-020 1068584-020 1068584-1 1068590-020 1068590-1	1065812-040 1068584-040 1068584-1 1068590-040 1068590-1	1065812-055 1068584-055 1068584-1 1068590-055 1068590-1	1068584-1	1065812-080 1068584-080 1068584-1 1068590-080 1068590-1	1065812-150 1068584-150 1068584-1 1068590-150 1068590-1
<b>AC Input/ RFI Filter (A5)</b>	1068560-1	1068560-1	1068560-1	1068560-1	1068560-1	1068560-3	1068560-1	1068560-1
<b>AC Input Rectifier (A6)</b>	5360141-01	5360141-01	5360141-01	5360141-01	5360141-01	5360141-01	5360141-01	5360141-01
<b>Ripple Current (A9)</b>	1068892-008	1068892-012	1068892-020	—	—	—	—	—
<b>Rectifier (A10)</b>	—	—	—	—	—	—	—	1069126-1

This page intentionally left blank.

# SECTION 7

## APPLICATION NOTES

### 7.1 BATTERY CHARGING

When using the DCS-E Series (3kW) power supply to charge a battery, take the following precautions to prevent damage to the supply and/or the battery **in case the overvoltage protection (OVP) circuit is activated.**

- Select a diode rated to handle the required charging current and voltage. Use the following table as a reference.

Peak Charging Current	Maximum Voltage	Diode Type
250-350A	40V	Two (2) parallel MBR30045CT
60-249A	40V	One (1) MBR30045CT
25-59A	100V	One (1) MUR7015
10-24A	300V	One (1) MUR3040PT
5-9A	500V	One (1) MUR1560
<5A	600V	One (1) MUR758

- Connect the diode in series with either supply output to prevent the battery from discharging through the internal OVP crowbar transistor. The diode must be mounted on a suitably-rated heatsink to prevent its case temperature from exceeding the manufacturer's maximum limits.

### 7.2 LOAD CONSIDERATIONS

Properly rated diodes should be used to protect the power supply from damage while driving inductive loads.

#### 7.2.1 Inductive Loads

To prevent damage to the power supply from inductive kickback, connect a diode (rated at greater than the supply's output voltage and current) across the output.

It is recommended that diode and cathode connections be made as follows:

- Connect a blocking diode in series with the output to protect the power supply.
- Connect cathode of the freewheeling diode to the cathode of the blocking diode and the anode to return.

### BLOCKING AND FREE WHEELING DIODES

The Peak Reverse Voltage ratings should be a minimum of 2-3 times the Power Supply maximum output voltage. The Continuous Forward Current ratings should be a minimum of 1.5 times the Power Supply maximum output current. Heatsink may be required. There also may be a need for higher voltage rated parts, dependent on load circuit design and inductor values.

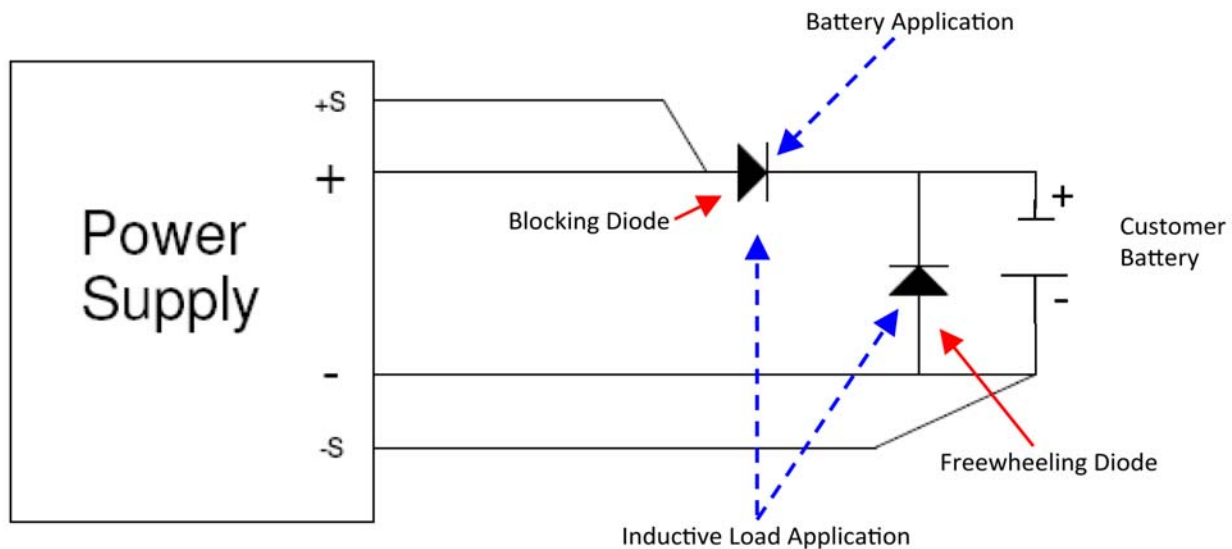

**Figure 7-1. Diode Connection**

Customer Application Notes:

When positive sense is connected to anode of Blocking Diode (as shown in Figure 7-1), voltage applied to the customer load will be lower than the output of the power supply due to the forward voltage drop of the diode.

When load regulation is required, the positive sense can be connected directly to the load, but the battery may discharge thru the sense leads, causing damage to the power supply.