

High Performance Programmable AC and DC Power Source

156–312 V

- Combination AC and DC Power Source
- 40-5,000Hz Output Frequencies
- Arbitrary and Harmonic Waveform Generation
- Built-In Digital Power Analyzer
- Scope Capture Capability
- Power Programming Software
- Constant Power Mode
- Multi-Box Option



8–288 A



208

230

400

ETHERNET

USB

↳ GPIB

RS232

Introduction

The CSW Series represents a new generation of AC/DC power sources that address the increasing demands on test equipment to perform additional functions at a lower cost. By combining a flexible AC/DC power source with a high performance power analyzer, the Compact CSW Series is capable of handling complex applications that have traditionally required multiple systems. The sleek integrated approach of the CSW avoids cable clutter that is commonly found in test systems. All connections are made internally and the need for digital multimeters, power harmonics analyzers, and current shunts or clamps is eliminated.

Since many components in the CSW are shared between the AC/DC source and the power analyzer, the total cost of the integrated system is less than the typical cost of a multiple unit system.

Easy to use controls

The CSW Series is DSP controlled and can be operated from an easy to use front panel keypad. Functions are grouped logically and are directly accessible from the keypad. This eliminates the need to search through various levels of menus and/or soft keys. A large analog control knob can be used to quickly slew output parameters. This knob is controlled by a dynamic rate change algorithm that combines the benefits of precise control over small parameter changes with quick sweeps through the entire range.

Applications

The CSW is designed for testing today's complex electronics, including avionics, telecommunications and commercial electronics requiring low profile, light weight power supplies

Other applications include:

- Testing for real world power conditions using different waveforms on all 3 phases (including DC)
- Load susceptibility testing with sequence or event programming and multiple voltage harmonics
- Power line disturbance simulation testing
- MIL-STD-704, DO-160, B787 and ABD100 avionics testing
- Power supply testing for AC-DC, DC-DC converters and UPS's
- Transients on 12 & 24 VDC for automotive applications

AC, DC or AC+DC Output

A direct coupled, transformerless design allows AC and DC on separate phases or on the same phase. The CSW can be used as a true DC power supply. High DC content waveforms (up to 312 volts) can be created with no derating of output power, even with 100% reactive loads, eliminating the need for a separate DC supply. Waveform programming is easily accomplished using the Graphical Users Interface software. Waveforms can be uploaded and modified from a digital scope. The waveforms can then be downloaded to the CSW and output to precisely simulate real-world conditions.

AMETEK
Programmable Power
 9250 Brown Deer Road
 San Diego, CA 92121-2267
 USA

AMETEK[®]
 PROGRAMMABLE POWER

Flexibility in Power Ranges

The CSW Series is based on a 5,550VA power source. The CSW features selectable Single or Three Phase output via front panel menu selection or via remote control interface. Utilizing Master / Auxiliary arrangement the CSW offers the flexibility to parallel up to power levels of 33,300VA

High Crest Factor

With a crest factor of up to 3.25:1; the CSW Series AC source can drive difficult nonlinear loads with ease. Since many modern products use switching power supplies, they have a tendency to pull high repetitive peak currents. The CSW5550 can deliver up to 38.5 Amps of repetitive peak current (156 V range) per phase



Harmonic Waveform Generation

Using the latest DSP technology, the CSW Series programmable controller is capable of generating harmonic waveforms to test for harmonics susceptibility. The Windows Graphical User Interface program can be used to define harmonic waveforms by specifying amplitude and phase for up to 50 harmonics. The waveform data points are generated and downloaded by the GUI to the AC source through the remote interface. Up to 200 waveforms can be stored in nonvolatile memory and given a user defined name for easy recall.

Arbitrary Waveform Generation

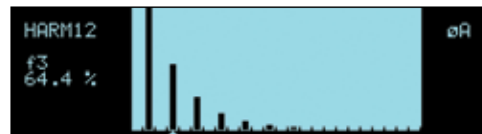

Harmonic waveform, Fund., 3rd, 5th, 7th, 9th, 11th and 13th.

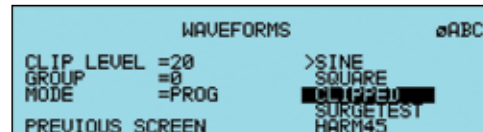

Two hundred user defined waveforms.

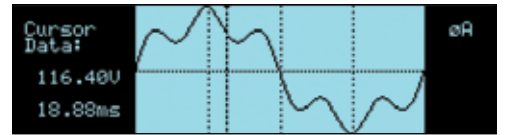

Harmonically distorted waveform.

Using the provided GUI program or custom software, the user also has the ability to define arbitrary AC waveforms. The arbitrary waveform method of data entry provides an alternative method of specifying AC anomalies by providing specific waveform data points. The GUI program provides a catalog of custom waveforms and also allows real-world waveforms captured on a digital oscilloscope to be downloaded to one of the many AC source's waveform memories. Arbitrary waveform capability is a flexible way of simulating the effect of real-world AC power line conditions on a unit under test in both engineering and production environments.

CSW Series - AC and DC Transient Generation

The CSW Series controller has a powerful AC and DC transient generation system that allows complex sequences of voltage, frequency and waveshapes to be generated. This further enhances the CSW's capability to simulate AC line conditions or DC disturbances. When combined with the multiphase arbitrary waveform capabilities, the AC and DC output possibilities are truly exceptional. Transient generation is controlled independently yet time synchronized on all three phases. Accurate phase angle control and synchronized transient list execution provide unparalleled accuracy in positioning AC output events.

Transient programming is easily accomplished

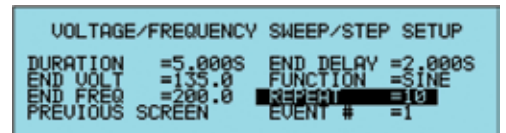

Transient List Data Entry from the front panel.

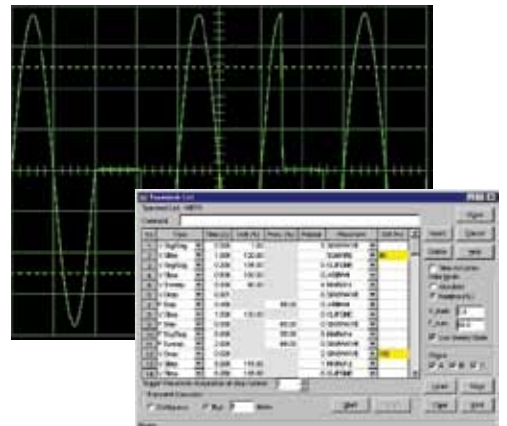

Transient List Data Entry in GUI program.

from the front panel where clearly laid out menu's guide the user through the transient definition process.

The front panel provides a convenient listing of the programmed transient sequence and allows for transient execution Start, Stop, Abort and Resume operations. User defined transient sequences can be saved to non-volatile memory for instant recall and execution at a later time. The included Graphical User Interface program supports transient definitions using a spreadsheet-like data entry grid. A library of frequently used transient programs can be created on disk using this GUI program.

Harmonic Analysis

The CSW Series provides detailed amplitude and phase information on up to 50 harmonics of the fundamental voltage and current (up to 16 kHz). Harmonic content can be displayed in both tabular and graphical formats on the front panel LCD for immediate feedback to the operator. Alternatively, the included GUI program can be used to display, print and save harmonic measurement data. Total harmonic distortion of both voltage and current is calculated from the harmonic data.

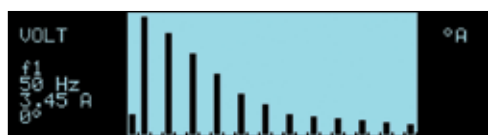

Absolute amplitude bar graph display of current harmonics with cursor positioned at the fundamental (CSW Display).

| HR# | AMPL. | PHASE | HR# | AMPL. | PHASE |
|--------|-------|-------|--------|-------|-------|
| 000000 | 113.5 | 0.0 | 000000 | 36.9 | 0.0 |
| 000001 | 1.5 | 115.1 | 000001 | 1.5 | 115.1 |
| 000002 | 1.2 | 111.1 | 000002 | 1.2 | 111.1 |
| 000003 | 1.0 | 107.2 | 000003 | 1.0 | 107.2 |
| 000004 | 0.8 | 103.3 | 000004 | 0.8 | 103.3 |
| 000005 | 0.7 | 99.4 | 000005 | 0.7 | 99.4 |
| 000006 | 0.6 | 95.5 | 000006 | 0.6 | 95.5 |
| 000007 | 0.5 | 91.6 | 000007 | 0.5 | 91.6 |
| 000008 | 0.4 | 87.7 | 000008 | 0.4 | 87.7 |
| 000009 | 0.3 | 83.8 | 000009 | 0.3 | 83.8 |
| 000010 | 0.2 | 79.9 | 000010 | 0.2 | 79.9 |
| 000011 | 0.1 | 76.0 | 000011 | 0.1 | 76.0 |
| 000012 | 0.1 | 72.1 | 000012 | 0.1 | 72.1 |
| 000013 | 0.1 | 68.2 | 000013 | 0.1 | 68.2 |
| 000014 | 0.1 | 64.3 | 000014 | 0.1 | 64.3 |
| 000015 | 0.1 | 60.4 | 000015 | 0.1 | 60.4 |
| 000016 | 0.1 | 56.5 | 000016 | 0.1 | 56.5 |
| 000017 | 0.1 | 52.6 | 000017 | 0.1 | 52.6 |
| 000018 | 0.1 | 48.7 | 000018 | 0.1 | 48.7 |
| 000019 | 0.1 | 44.8 | 000019 | 0.1 | 44.8 |
| 000020 | 0.1 | 40.9 | 000020 | 0.1 | 40.9 |

Voltage harmonic measurement table display in absolute values (CSW Display)

Waveform Acquisition

The measurement system is based on real-time digitization of the voltage and current waveforms using a 4K deep sample buffer. This time domain information provides detailed information on both voltage and current waveshapes. Waveform acquisitions can be triggered at a specific phase angle or from a transient program to allow precise positioning of the captured waveform with respect to the AC source output.

The front panel LCD displays captured waveforms with cursor readouts. The included GUI program also allows acquired waveform data to be displayed, printed, and saved to disk.

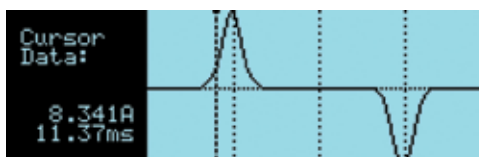

Acquired Current waveform (CSW Display).

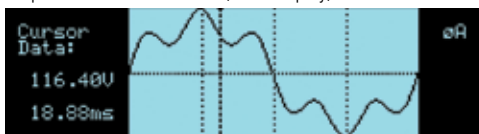

Acquired Voltage waveform (CSW Display).

| MEASUREMENTS 1 | | | |
|-----------------|----------|---------|--------|
| VOLTAGE = | 113.5VAC | FREQ = | 60.0Hz |
| CURRENT = | 36.9A | POWER = | 4.11KW |
| PREVIOUS SCREEN | | MORE | |

Measurement data for single phase (CSW Display).

| MEASUREMENTS1 | | | | aA | aB | aBC |
|-----------------|----------|----------|----------|----|----|-----|
| FREQ = | 60.0 Hz | | | | | |
| VOLT AC = | 120.51 U | 119.92 U | 120.31 U | | | |
| CURR = | 9.342 A | 8.453 A | 9.129 A | | | |
| POWER = | 0.782 KW | 0.763 KW | 0.754 KW | | | |
| PREVIOUS SCREEN | | MORE | | | | |

Measurement data for all three phases (CSW Display).

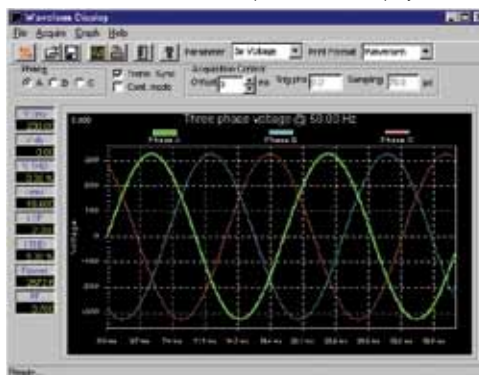

Acquired three phase voltage waveforms display on PC.

Multi-Box Option

In many applications high power is required for a small portion of the testing while a majority of the tests are performed at reduced power levels. The controller architecture of the CSW provides the end-user with a wide array of configuration options that often eliminate the need to purchase different AC or DC power systems to meet a variety of applications. The Multi-Box option is available which allows multiple channel systems to be separated into individually controlled stand alone power sources. By simply connecting the interface cable between multiple sources the hardware automatically sets itself to the system configuration offering Plug and Play performance. There is no need to modify configuration settings from the front panel or hardware jumpers located internally to the source. The multi-box feature is ideal for end-users planning to increase power levels or separate a system into multiple smaller sources.

CSW Series : Product Specifications

| Input | |
|--|--|
| Voltage Ranges | Factory configured 187 to 264 Vrms, 3 ϕ L-L (3 wire), or 342 to 457 Vrms, 3 ϕ L-L (4 wire). A chassis ground is also required. |
| Power Factor | PFC Input, 0.99PF |
| Frequency Range | 47 to 440 Hz |
| Efficiency | 70% min, at full load |
| Ride Through | 10 ms minimum |
| Output | |
| Power | 5550 VA: 1 ϕ or 3 ϕ (systems up to 33,000 VA) |
| AC or DC Output Voltage | 0 to 156 Vrms L-N, low range; 0 to 312 Vrms L-N, high range |
| Current Per Phase | 16A to 115V in 156V range; 8A to 230V in 312V range per, 1850 VA module. |
| Power Factor of Load | 0 lagging to 0 leading (0-unity) |
| Crest Factor | 3.25:1 (peak output current to rms output current) |
| Frequency Range | Specifications apply DC, 40Hz to 5kHz. For output frequencies greater than 1 kHz, the max slew rate allowed is 1 kHz per second. |
| Max Total Harmonic Distortion | (Full Linear Load or No Load): 0.25% max, 40 to 100 Hz; 0.5% max to 500 Hz; and 1% max to 1 kHz plus 1%/kHz to 5 kHz |
| AC Noise Level | >60 dB rms below full output voltage |
| Amplitude Stability With Remote Sense | $\pm 0.1\%$ of full scale over 24 hours at constant line, load and temperature |
| Line Regulation | (DC, or 40 Hz to 5 kHz): $\pm 0.015\%$ of full scale for a $\pm 10\%$ input line change |
| Load Regulation | $\pm 0.025\%$ of full scale voltage for a full resistive load to no load; above 1 kHz, add $\pm 0\%/kHz$ |
| Voltage Accuracy | $\pm 0.1\%$ of range. Above 1 kHz, add 0.2%/kHz. Add $\pm 0.1\%$ of full scale for "AC PLUS DC" mode. Valid for 5 to 156 Vrms and 10 to 312 Vrms at 25°C |
| Voltage Resolution | 1mV (0.1V) Full Scale |
| Frequency Accuracy | $\pm 0.01\%$ at 25°C $\pm 0.001\%/^{\circ}C$ |
| Frequency Resolution | 40 Hz to 81.91 Hz (0.01 Hz) 81.90 Hz to 819 Hz (0.01 Hz) 820 Hz to 5000 Hz (1 Hz) |
| Phase Accuracy, Phase-to-Phase Balanced Linear Resistive Load | $\pm 1\%$ of Programmed value |
| Phase Angle Resolution | 0.1° |
| Remote Output Voltage Sense | 5 Vrms total lead drop, max |
| Common Input and Outputs | |
| Remote Inhibit | A logic Low or High contact closure input to inhibit the outputs |
| External Amplitude Modulation | 0 to 5 VRMS provides 0 to 20% output amplitude modulation ($\pm 2\%$ of full scale output). |
| External Drive Input | Acts as Amplifier, 0 to 5 VRMS (DC to 5 kHz) or ± 5 VDC input for zero to full scale programmed voltage output ($\pm 2\%$ of full scale output). Individual inputs for an external signal for each of the three phases. |
| Remote Programming Voltage | 0 to ± 7.07 VDC provides zero to full scale programmed voltage output ($\pm 2\%$ of full scale output). |
| External Input Impedance | 40K (ohm symbol) for each of the three inputs. |
| Externally Sync | External Sync allows the output frequency of the AC source to be synchronized to an external TTL level clock signal. |
| LKM | Clock and Lock Master. Enables synchronizing outputs of two or more California Instruments sources, one acts as master. |
| LKS | Clock and Lock Auxiliary |
| Front Panel Trigger, BNC Connector | Output available at the front panel BNC connector that provides a negative going pulse for any programmed voltage or frequency change. The trigger can be reassigned as an output when running list transients. |
| Front Panel Phase A, B and C, BNC connectors | These three outputs are representative of the programmed output waveform, magnitude and frequency. 0 to 4.86 Vrms represents 0 to a full-scale output voltage. |

| Environmental | |
|---------------------------|--|
| Operating Temperature | 0°C to 45°C (32°F to 113°F) |
| Storage Temperature | -40°C to 70°C (-40°F to 158°F) |
| Cooling | Air is drawn in from the top, bottom, and sides and exhausted through the rear |
| Humidity (Non-condensing) | 0 to 85% at 25°C (77°F); derate to 50% at 40°C (104°F) |
| Altitude | Operating 10,000 ft, non operating 40,000 ft |

| Physical | |
|----------------------|--|
| Dimensions | Width: 19" (483 mm) Height: 8.75" (222 mm) Depth: 23.5" (597 mm) |
| Weight | CSW 5550 - 127 lbs (57.5 kg) |
| Shipping Weight - US | CSW - 160 lbs (72 kg) |
| Note | Multi Chassis systems, dimension and weight are approximately x2, x3, x4, x5 and x6 CSW Specifications |

| Measurements | | | | | | | | |
|--|------------------------|--|--------------------------|---------------|------------------|-------------|----------------|--------------|
| Measurements - Standard (AC Measurements) | Parameter | Frequency | Phase | Voltage (AC) | Current (AC rms) | Real Power | Apparent Power | Power Factor |
| | Range | 40-81.91 Hz 82.0-819.1 Hz > 819 Hz | 40-100 Hz 100-1000 Hz | 0-300 V | 0-50 A | 0-6 kW | 0-6 kVA | 0.00-1.00 |
| | Accuracy* (±) | | | | | | | |
| | 1 Ø mode (-1) | 0.1% + 1 digit | 0.5° | 0.5% + 250 mV | 0.1% + 150 mA | 0.15% + 9 W | 0.15% + 9 VA | 0.03 |
| | 3 Ø mode (-3) | | 2° | | 0.1% + 50 mA | 0.15% + 3 W | 0.15% + 3 VA | 0.01 |
| Resolution* | .01 Hz / 0.1 Hz / 1 Hz | 0.1° / 1° | 10 mV | 1 mA | 1 W | 1 VA | 0.01 | |

* Accuracy specifications are in % of reading and apply above 100 counts. For multi-chassis configurations, current, power range and accuracy specifications are times three. Power factor accuracy applies for PF > 0.5 and VA > 50% of max. Frequency measurement specification valid for output > 30 Vrms.

Constant Power AC Mode

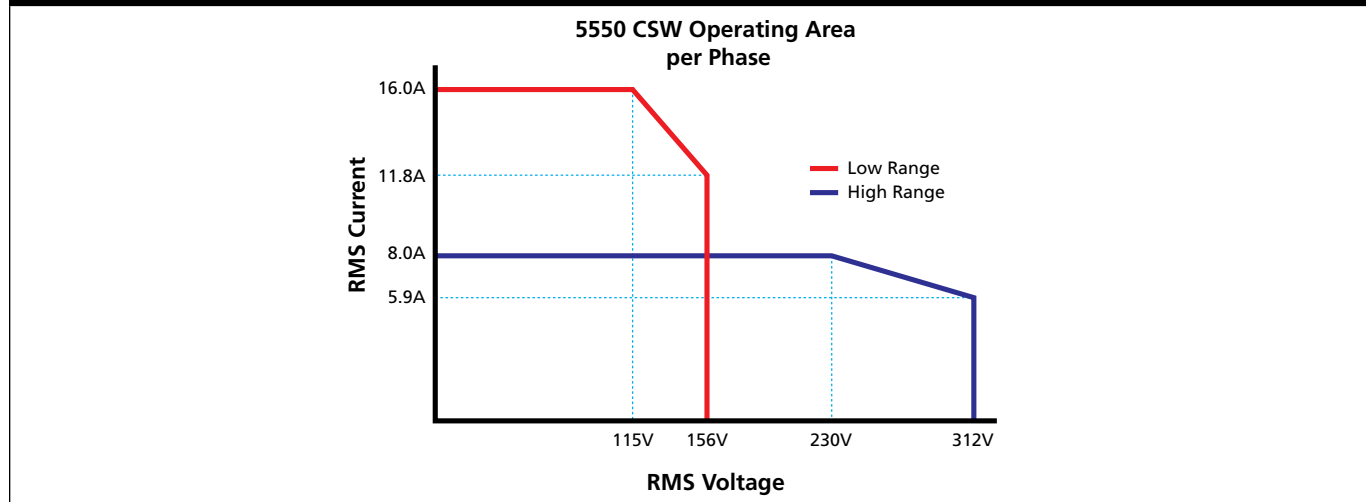

| Harmonic Measurements | | | |
|-----------------------|-------------------|-------------------------|-----------------|
| Parameter | Range | Accuracy (±) | Resolution |
| Frequency fundamental | 16.00 - 1000 Hz | 2 counts | 0.01 Hz to 1 Hz |
| Frequency harmonics | 32.00 Hz - 16 kHz | 2° typ. | 0.5° |
| Voltage | Fundamental | 0.25V | 0.01V |
| | Harmonic 2 - 50 | 0.25V + 0.1% + 0.1%/kHz | 0.01V |
| Current | Fundamental | 0.05A | 0.01A |
| | Harmonic 2 - 50 | 0.05A + 0.1% + 0.1%/kHz | 0.01A |

Harmonics frequency range in three-phase mode is 32 Hz - 16 kHz. Accuracy specifications are multiplied by the number of power sources in multi-source systems with the 3-phase (3Ø) or the number of sources times 3 in the 1-phase (1Ø) mode . Measurement bandwidth is limited to 16 KHz.

| Model | CSW5550 | CSW11100 | CSW16650 | CSW22200 | CSW17750 | CSW33300 |
|-------------------|---------|----------|----------|----------|----------|----------|
| Multiplier 3Ø/1 Ø | 1/3 | 2/6 | 3/9 | 4/12 | 5/15 | 6/18 |

CSW Series : Product Specifications

| Protection And Safety | |
|--|--|
| Overvoltage Shutdown | Programmable for 15V to 255V peak, 156V range; 30V to 510V peak, 312V range |
| Programmable Current Limit Shutdown | Settable to 0.01 ARMS Resolution |
| Programmable Current Limit with Timed Shutdown | Settable to 1% of range: the timeout is settable from 100 ms to 10s. |
| Over temperature Shutdown | Automatic, not programmable |
| Regulatory Compliance | <ul style="list-style-type: none"> • EN 61010 • EN 55011 • UL 3111 • EN 50082-2 • EN 61000-4-3, EN 61000-4-4 • FCC Part 15, Class A • CE Mark Designed to meet: <ul style="list-style-type: none"> • EN 61010 • EN 55011 • UL 3111 • EN 50082-2 • EN 61000-4-3, EN 61000-4-4 • FCC Part 15, Class A |

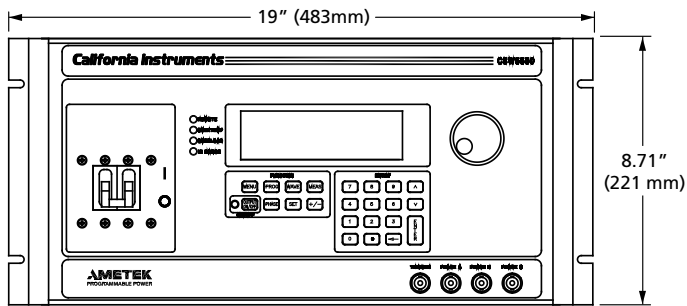

Front View

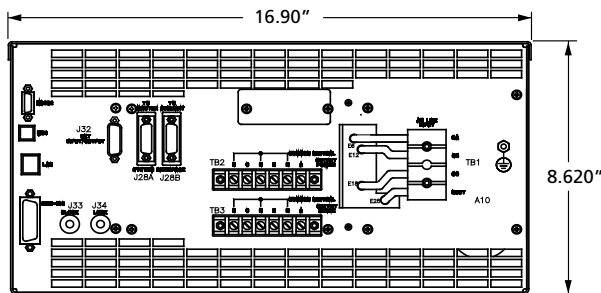

Rear View

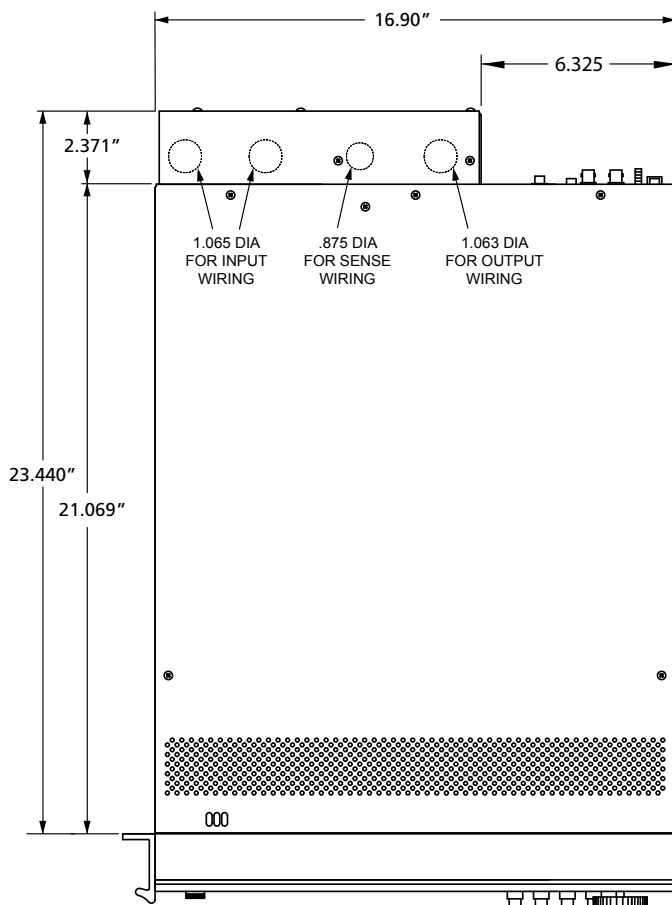

Top View

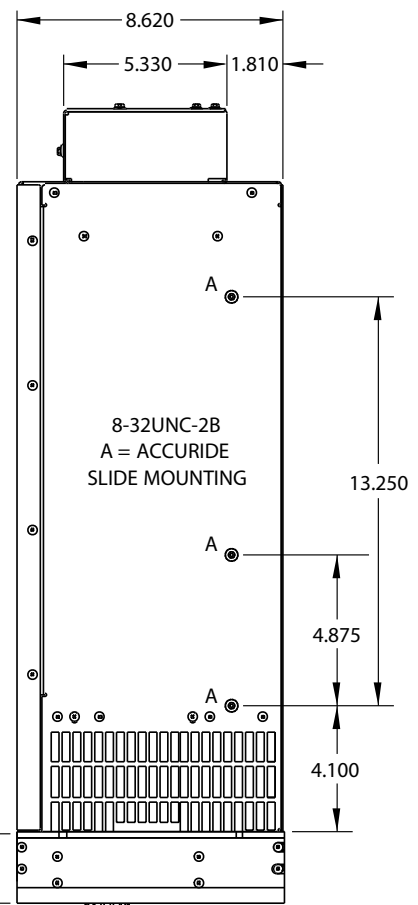

Side View

CSW Series

Model Number Description

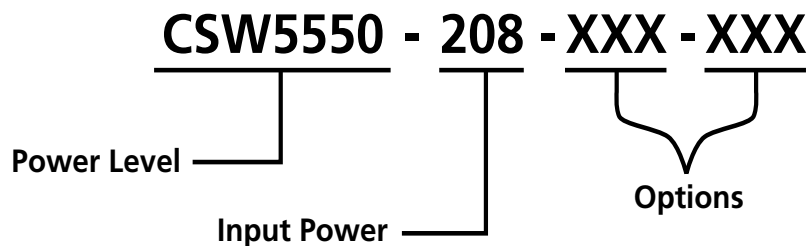

Options

| Options Code | Description |
|------------------------|---|
| -160 | RTCA/DO-160D, Change 2, EuroCAE-14D and Airbus test firmware. |
| -704F | Mil. Std. 704A-F tests |
| -ABD | Airbus Directive 0100.1.8 tests. |
| -AMD | Airbus AMD24 tests. |
| -A350 | Airbus A350 tests. |
| -B787 | Boeing 787B3-0147 tests. |
| -AIRB | Airbus ABD0100.1.8, AMD 24 and A350 combination test software suite |
| -LAN | LXI Ethernet LAN Interface (Rj45 Connector) |
| -LKM | Clock/Lock Master |
| -LKS | Clock/Lock Auxiliary |
| -413 | IEC61000-4-13 Harmonics and Interharmonics test firmware and hardware. |
| -411 | IEC61000-4-11 test firmware. See also EOS1/3. |
| -WHM | Watt-Hour Measurement option. |
| -MB | Multi-Box. Adds controller to auxiliary chassis of multi-chassis systems |
| -SW | SCPI Command Firmware (Simulates the Elgar SW Series) Not all commands are supported. Please contact factory for details. |
| Input Options | |
| -400 | 342-457 Volt Line to Line AC input. |
| Output Options | |
| -LF | Limits output frequency to 500 Hz. |
| Cabinet Options | |
| -RMS | Rackmount Slides. Recommended for rack mount applications. |
| C prefix | Cabinet System. Installed and pre-wired in 19" cabinet. |

© 2011 AMETEK Programmable Power All rights reserved. AMETEK Programmable Power is the trademark of AMETEK Inc., registered in the U.S. and other countries. Elgar, Sorensen, California Instruments, and Power Ten are trademarks of AMETEK Inc., registered in the U.S.