

Mixed Signal Oscilloscopes

MSO3000 Series, DPO3000 Series Datasheet

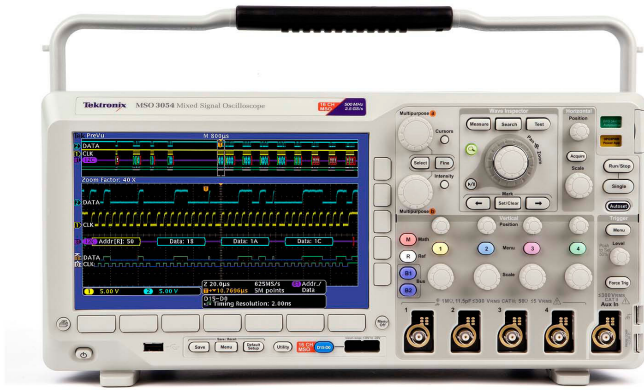

Features & Benefits

Key Performance Specifications

- 500, 300, 100 MHz Bandwidth Models
- Bandwidth is Upgradable (Up to 500 MHz)
- 2 and 4 Analog Channel Models
- 16 Digital Channels (MSO Series)
- 2.5 GS/s Sample Rate on All Channels
- 5 Megapoint Record Length on All Channels
- >50,000 wfms Maximum Waveform Capture Rate
- Suite of Advanced Triggers

Ease of Use Features

- Wave Inspector® Controls provide Easy Navigation and Automated Search of Waveform Data
- 29 Automated Measurements, and FFT Analysis for Simplified Waveform Analysis
- TekVPI® Probe Interface Supports Active, Differential, and Current Probes for Automatic Scaling and Units
- 9 in. (229 mm) WVGA Widescreen Color Display
- Small Footprint and Lightweight – Only 5.8 in. (147 mm) deep and 9 lb. (4 kg)

Connectivity

- USB 2.0 Host Port on both the Front Panel and Rear Panel for Quick and Easy Data Storage, Printing, and Connecting a USB Keyboard
- USB 2.0 Device Port on Rear Panel for Easy Connection to a PC or Direct Printing to a PictBridge®-compatible Printer
- Integrated 10/100 Ethernet Port for Network Connection and Video Out Port to Export the Oscilloscope Display to a Monitor or Projector

Optional Serial Triggering and Analysis

- Automated Serial Triggering, Decode, and Search Options for I²C, SPI, MIL-STD-1553, CAN, LIN, FlexRay, RS-232/422/485/UART, and I²S/LJ/RJ/TDM

Mixed Signal Design and Analysis (MSO Series)

- Automated Triggering, Decode, and Search on Parallel Buses
- Multichannel Setup and Hold Triggering
- MagniVu™ High-speed Acquisition Provides 121.2 ps Fine Timing Resolution on Digital Channels

Optional Application Support

- Power Analysis
- HDTV and Custom Video Analysis

Feature-rich Tools for Debugging Mixed Signal Designs

With the MSO/DPO3000 Mixed Signal Oscilloscope Series, you can analyze up to 20 analog and digital signals with a single instrument to quickly find and diagnose problems in complex designs. Bandwidths up to 500 MHz and a minimum of 5X oversampling on all channels ensure you have the performance you need for many of today's mainstream applications. To capture long windows of signal activity while maintaining fine timing resolution, the MSO/DPO3000 offers a deep record length of 5 Mpoints standard on all channels.

With Wave Inspector® controls for rapid waveform navigation, automated serial and parallel bus analysis, and automated power analysis – the MSO/DPO3000 Oscilloscope Series from Tektronix provides the feature-rich tools you need to simplify and speed debug of your complex design.

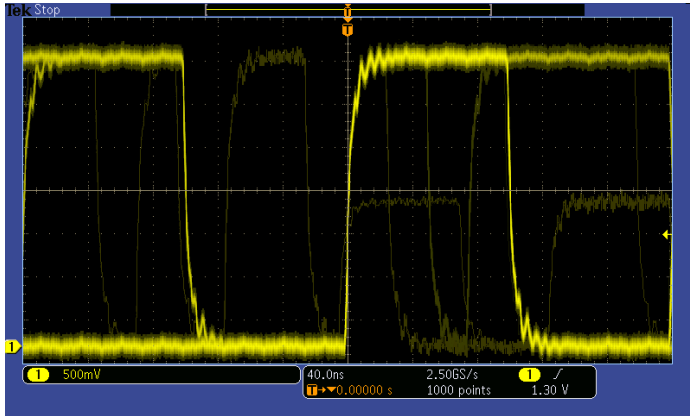

Discover – Fast waveform capture rate - over 50,000 wfms - maximizes the probability of capturing elusive glitches and other infrequent events.

Comprehensive Features Speed Every Stage of Debug

The MSO/DPO3000 Series offers a robust set of features to speed every stage of debugging your design – from quickly discovering an anomaly and capturing it, to searching your waveform record for the event and analyzing its characteristics and your device's behavior.

Discover

To debug a design problem, first you must know it exists. Every design engineer spends time looking for problems in their design, a time-consuming and frustrating task without the right debug tools.

The MSO/DPO3000 Series offers the industry's most complete visualization of signals, providing fast insight into the real operation of your device. A fast waveform capture rate – greater than 50,000 waveforms per second – enables you to see glitches and other infrequent transients within seconds, revealing the true nature of device faults. A digital phosphor display with intensity grading shows the history of a signal's activity by intensifying areas of the signal that occur more frequently, providing a visual display of just how often anomalies occur.

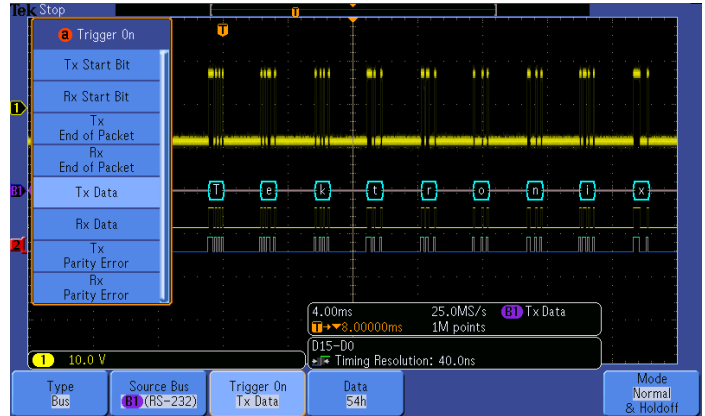

Capture – Triggering on a specific transmit data packet going across an RS-232 bus. A complete set of triggers, including triggers for specific serial packet content, ensures you quickly capture your event of interest.

Capture

Discovering a device fault is only the first step. Next, you must capture the event of interest to identify root cause.

Addressing a wide range of performance needs, the MSO/DPO3000 Series includes models with analog bandwidths of 100 MHz, 300 MHz, or 500 MHz. Tektronix knows your project requirements can change over time, creating a need for improved oscilloscope performance. The MSO/DPO3000 Series lets you purchase the bandwidth you need now, and simply upgrade it (up to 500 MHz) when your project requirements change – without purchasing a whole new instrument.

The MSO/DPO3000 Series provides a complete set of triggers – including runt, logic, pulse width/glitch, setup/hold violation, serial packet, and parallel data – to help quickly find your event. With up to a 5 Mpoint record length, you can capture many events of interest, even thousands of serial packets, in a single acquisition for further analysis while maintaining high resolution to zoom in on fine signal details.

From triggering on specific packet content to automatic decode in multiple data formats, the MSO/DPO3000 Series provides integrated support for the industry's broadest range of serial buses – I²C, SPI, MIL-STD-1553, CAN, LIN, FlexRay, RS-232/422/485/UART, and I²S/LJ/RJ/TDM. The ability to decode up to two serial and/or parallel buses simultaneously means you gain insight into system-level problems quickly.

To further help troubleshoot system-level interactions in complex embedded systems, the MSO3000 Series offers 16 digital channels in addition to its analog channels. Since the digital channels are fully integrated into the oscilloscope, you can trigger across all input channels, automatically time-correlating all analog, digital, and serial signals. The MagniVu™ high-speed acquisition enables you to acquire fine signal detail (up to 121.2 ps resolution) around the trigger point for precision measurements. MagniVu is essential for making accurate timing measurements for setup and hold measurements, clock delay, signal skew, and glitch characterization.

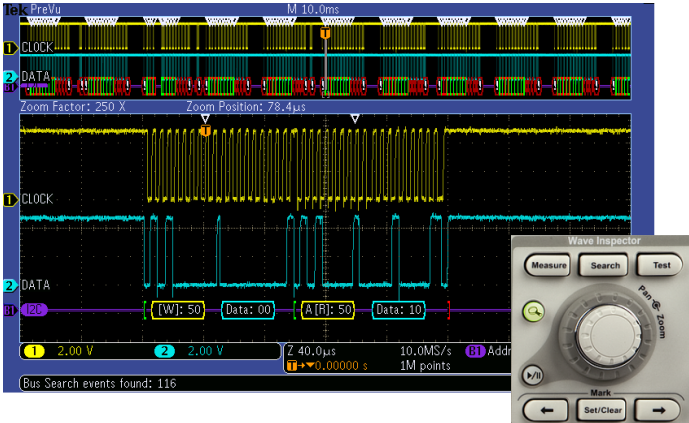

Search – I2C decode showing results from a Wave Inspector search for Address value 50. Wave Inspector controls provide unprecedented efficiency in viewing and navigating waveform data.

Search

Finding your event of interest in a long waveform record can be time consuming without the right search tools. With today's record lengths pushing beyond a million data points, locating your event can mean scrolling through thousands of screens of signal activity.

The MSO/DPO3000 Series offers the industry's most comprehensive search and waveform navigation with its innovative Wave Inspector® controls. These controls speed panning and zooming through your record. With a unique force-feedback system, you can move from one end of your record to the other in just seconds. User marks allow you to mark any location that you may want to reference later for further investigation. Or, automatically search your record for criteria you define. Wave Inspector will instantly search your entire record, including analog, digital, and serial bus data. Along the way it will automatically mark every occurrence of your defined event so you can quickly move between events.

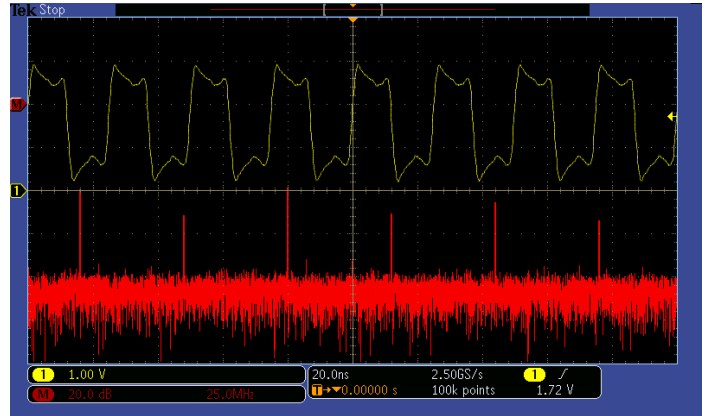

Analyze – FFT analysis of a pulsed signal. A comprehensive set of integrated analysis tools speeds verification of your design's performance.

Analyze

Verifying that your prototype's performance matches simulations and meets the project's design goals requires analyzing its behavior. Tasks can range from simple checks of rise times and pulse widths to sophisticated power loss analysis and investigation of noise sources.

The MSO/DPO3000 Series offers a comprehensive set of integrated analysis tools including waveform- and screen-based cursors, 29 automated measurements, advanced waveform math including arbitrary equation editing, FFT analysis, and trend plots for visually determining how a measurement is changing over time. Specialized application support for serial bus analysis, power supply design, and video design and development is also available.

For extended analysis, National Instrument's LabVIEW SignalExpress™ Tektronix Edition provides over 200 built-in functions including time and frequency domain analysis, limit testing, data logging, and customizable reports.

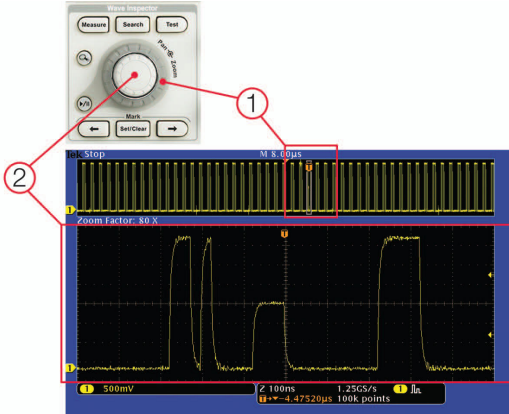

Wave Inspector controls provide unprecedented efficiency in viewing, navigating, and analyzing waveform data. Zip through your 5 Mpoint record by turning the outer pan control (1). Get from the beginning to end in seconds. See something of interest and want to see more details? Just turn the inner zoom control (2).

Wave Inspector® Navigation and Search

A 5 Mpoint record length represents thousands of screens of information. The MSO/DPO3000 Series enables you to find your event in seconds with Wave Inspector, the industry's best tool for navigation and search.

Wave Inspector offers the following innovative controls:

Zoom/Pan

A dedicated, two-tier front-panel control provides intuitive control of both zooming and panning. The inner control adjusts the zoom factor (or zoom scale); turning it clockwise activates zoom and goes to progressively higher zoom factors, while turning it counterclockwise results in lower zoom factors and eventually turning zoom off. No longer do you need to navigate through multiple menus to adjust your zoom view. The outer control pans the zoom box across the waveform to quickly get to the portion of waveform you are interested in. The outer control also utilizes force-feedback to determine how fast to pan on the waveform. The farther you turn the outer control, the faster the zoom box moves. Pan direction is changed by simply turning the control the other way.

Play/Pause

A dedicated **Play/Pause** front-panel button scrolls the waveform across the display automatically while you look for anomalies or an event of interest. Playback speed and direction are controlled using the intuitive pan control. Once again, turning the control further makes the waveform scroll faster and changing direction is as simple as turning the control the other way.

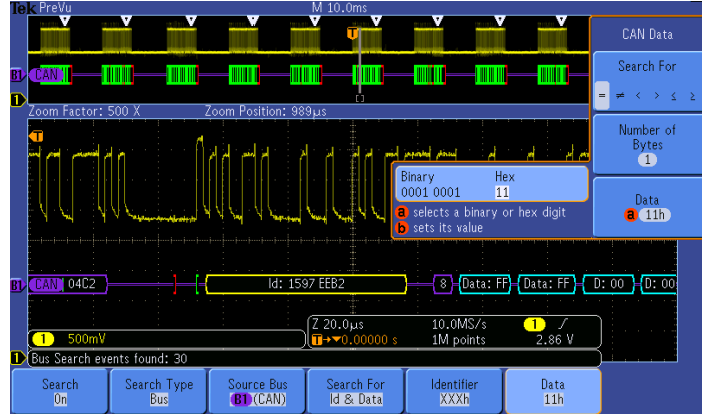

Search step 1: You define what you would like to find.

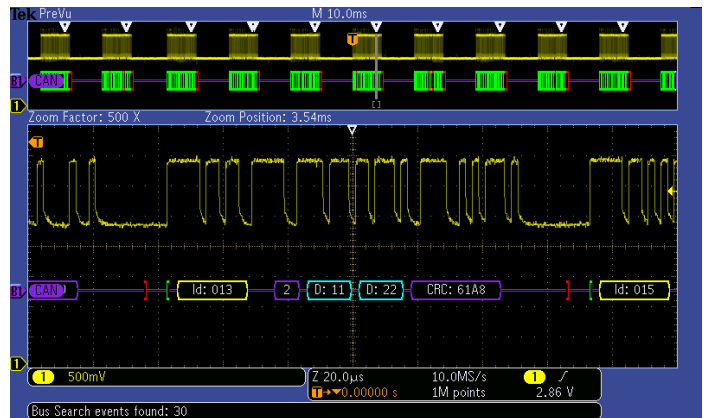

Search step 2: Wave Inspector automatically searches through the record and marks each event with a hollow white triangle. You can then use the **Previous** and **Next** buttons to jump from one event to the next.

User Marks

Press the **Set Mark** front-panel button to place one or more marks on the waveform. Navigating between marks is as simple as pressing the **Previous** (←) and **Next** (→) buttons on the front panel.

Search Marks

The **Search** button allows you to automatically search through your long acquisition looking for user-defined events. All occurrences of the event are highlighted with search marks and are easily navigated to, using the front-panel **Previous** (←) and **Next** (→) buttons. Search types include edge, pulse width/glitch, runt, logic, setup and hold, rise/fall time parallel bus, and I²C, SPI, MIL-STD-1553, CAN, LIN, FlexRay, RS-232/422/485/UART, and I²S/LJ/RJ/TDM packet content.

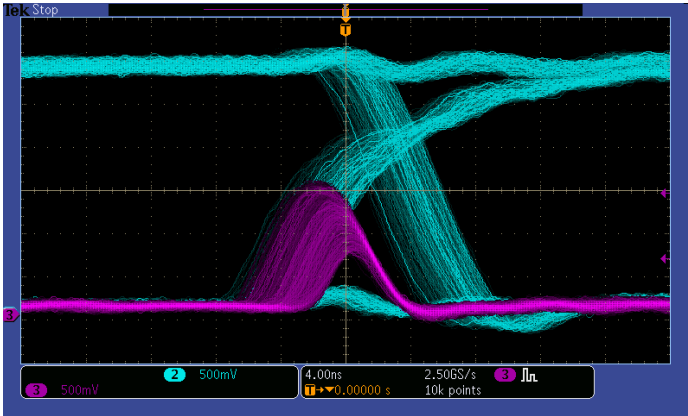

Digital phosphor technology enables greater than 50,000 wfms capture rate and real-time intensity grading on the MSO/DPO3000 Series.

Digital Phosphor Technology

The MSO/DPO3000 Series' digital phosphor technology provides you with fast insight into the real operation of your device. Its fast waveform capture rate – greater than 50,000 wfms – gives you a high probability of quickly seeing the infrequent problems common in digital systems: runt pulses, glitches, timing issues, and more.

Waveforms are superimposed with one another and waveform points that occur more frequently are intensified. This quickly highlights the events that over time occur more often or, in the case of infrequent anomalies, occur less often.

With the MSO/DPO3000 Series, you can choose infinite persistence or variable persistence, determining how long the previous waveform acquisitions stay on-screen. This allows you to determine how often an anomaly is occurring.

Mixed Signal Design and Analysis (MSO Series)

The MSO3000 Series Mixed Signal Oscilloscopes provide 16 digital channels. These channels are tightly integrated into the oscilloscope's user interface, simplifying operation and making it possible to solve mixed-signal issues easily.

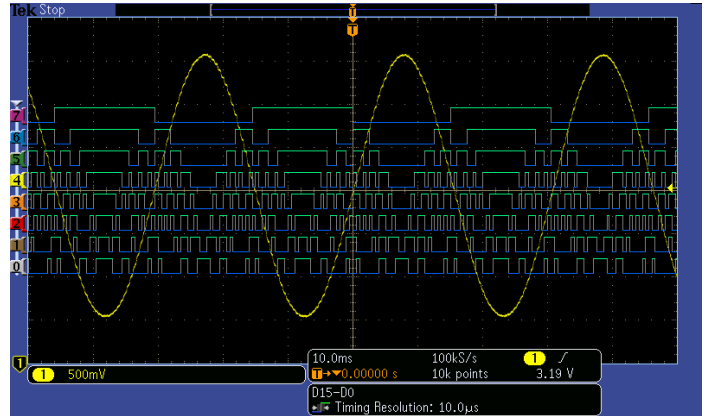

The MSO Series provides 16 integrated digital channels enabling you to view and analyze time-correlated analog and digital signals.

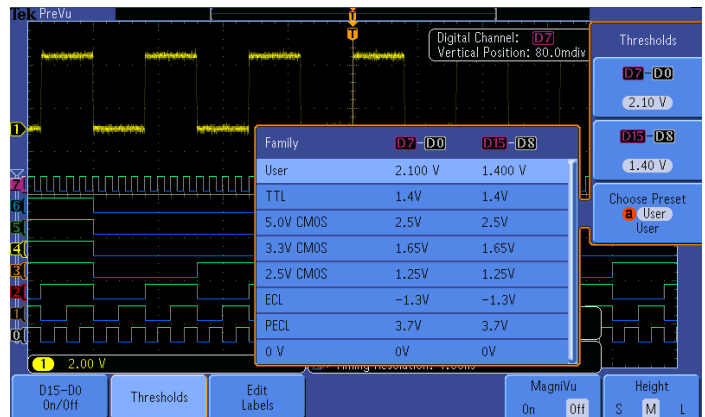

With the color-coded digital waveform display, groups are created by simply placing digital channels together on the screen, allowing the digital channels to be moved as a group. You can set threshold values for each pod of eight channels, enabling support for up to two different logic families.

Color-coded Digital Waveform Display

The MSO3000 Series has redefined the way you view digital waveforms. One common problem shared by both logic analyzers and mixed-signal oscilloscopes is determining if data is a one or a zero when zoomed in far enough that the digital trace stays flat all the way across the display. The MSO3000 Series has color-coded digital traces, displaying ones in green and zeros in blue.

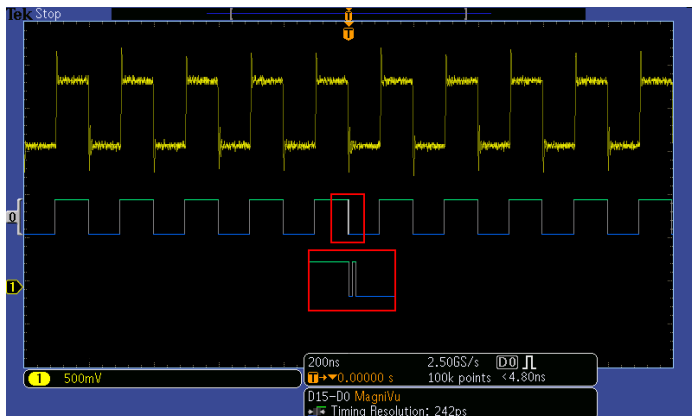

White edges indicate additional information is available by zooming in. As shown here, zooming in on the white edge reveals a hidden glitch.

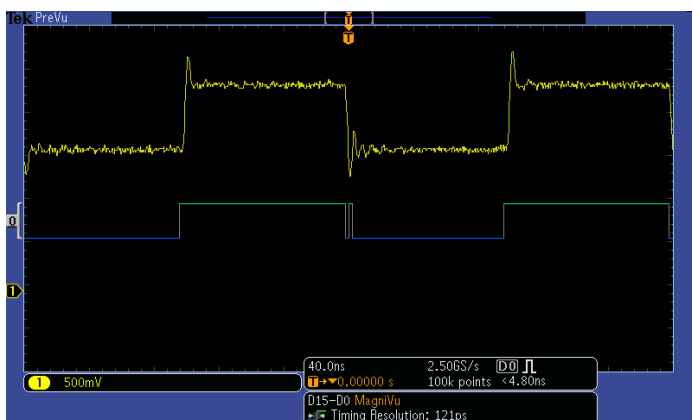

The MagniVu high-resolution record provides 121.2 ps timing resolution, enabling you to make critical timing measurements on your digital waveforms.

The multiple transition detection hardware of the MSO3000 Series will show you a white edge on the display when the system detects multiple transitions. White edges indicate that more information is available by zooming in or acquiring at faster sampling rates. In most cases zooming in will reveal the pulse that was not viewable with the previous settings. If the white edge is still present after zooming in as far as possible, this indicates that increasing the sample rate on the next acquisition will reveal higher frequency information than the previous settings could acquire.

The MSO3000 Series simplifies channel setup by allowing you to group digital waveforms and enter waveform labels by using a USB keyboard. By simply placing digital waveforms next to each other, they form a group.



The P6316 MSO probe offers two eight-channel pods to simplify connecting to your device.

Once a group is formed, you can position all the channels contained in that group collectively. This greatly reduces the normal setup time associated with positioning channels individually.

MagniVu™ High-speed Acquisition

The main digital acquisition mode on the MSO3000 Series will capture up to 5 Mpoints at 500 MS/s (2 ns resolution). In addition to the main record, the MSO3000 provides an ultra high-resolution record called MagniVu which acquires 10,000 points at up to 8.25 GS/s (121.2 ps resolution). Both main and MagniVu waveforms are acquired on every trigger and can be switched between in the display at any time, running or stopped. MagniVu provides significantly finer timing resolution than comparable MSOs on the market, instilling confidence when making critical timing measurements on digital waveforms.

P6316 MSO Probe

This unique probe design offers two eight-channel pods, simplifying the process of connecting to the device under test. When connecting to square pins, the P6316 can connect directly to 8×2 square pin headers spaced on tenth-inch centers. When more attachment flexibility is required, you can use the included flying lead sets and grabbers to clip onto surface mount devices or test points. The P6316 offers outstanding electrical characteristics applying only 8 pF of capacitive loading with 101 kΩ input impedance.

Serial Triggering and Analysis (Optional)

On a serial bus, a single signal often includes address, control, data, and clock information. This can make isolating events of interest difficult. The MSO/DPO3000 Series offers a robust set of tools for debugging serial buses with automatic trigger, decode, and search for I²C, SPI, MIL-STD-1553, CAN, LIN, FlexRay, RS-232/422/485/UART, and I²S/LJ/RJ/TDM.

Serial Triggering

Trigger on packet content such as start of packet, specific addresses, specific data content, unique identifiers, etc. on popular serial interfaces such as I²C, SPI, MIL-STD-1553, CAN, LIN, FlexRay, RS-232/422/485/UART, and I²S/LJ/RJ/TDM.

Bus Display

Provides a higher-level, combined view of the individual signals (clock, data, chip enable, etc.) that make up your bus, making it easy to identify where packets begin and end and identifying subpacket components such as address, data, identifier, CRC, etc.

Bus Decoding

Tired of having to visually inspect the waveform to count clocks, determine if each bit is a 1 or a 0, combine bits into bytes, and determine the hex value? Let the oscilloscope do it for you! Once you've set up a bus, the MSO/DPO3000 Series will decode each packet on the bus, and display the value in hex, binary, decimal (LIN, FlexRay, and MIL-STD-1553 only), signed decimal (I²S/LJ/RJ/TDM only), or ASCII (MIL-STD-1553, and RS-232/422/485/UART only) in the bus waveform.

Event Table

In addition to seeing decoded packet data on the bus waveform itself, you can view all captured packets in a tabular view much like you would see in a software listing. Packets are time stamped and listed consecutively with columns for each component (Address, Data, etc.).

Search

Serial triggering is very useful for isolating the event of interest, but once you've captured it and need to analyze the surrounding data, what do you do? In the past, users had to manually scroll through the waveform

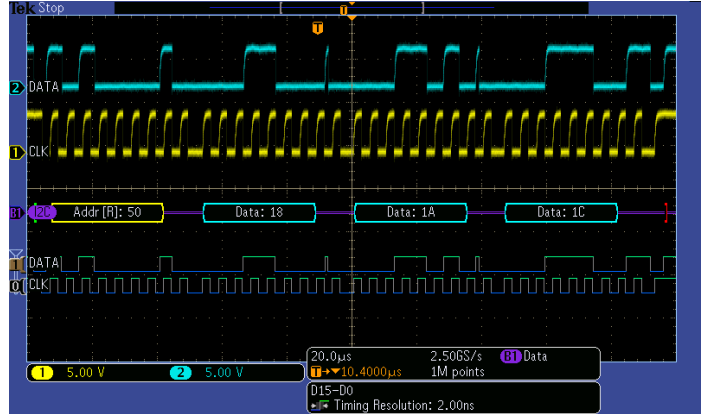

Triggering on a specific data packet going across an I²C bus. The yellow waveform is clock and the blue waveform is data. A bus waveform provides decoded packet content including Start, Address, Read/Write, Data, and Stop.



Event table showing decoded Identifier, DLC, DATA, and CRC for every CAN packet in a long acquisition.

counting and converting bits and looking for what caused the event. With the MSO/DPO3000 Series, you can have the oscilloscope automatically search through the acquired data for user-defined criteria including serial packet content. Each occurrence is highlighted by a search mark. Rapid navigation between marks is as simple as pressing the **Previous** (←) and **Next** (→) buttons on the front panel.

Technology		Trigger	Bus Decode	Event Table	Search	Order Product
Embedded	I ² C	X	X	X	X	DPO3EMBD
	SPI	X	X	X	X	DPO3EMBD
Computer	RS-232/422/485, UART	X	X	X	X	DPO3COMP
Automotive	CAN	X	X	X	X	DPO3AUTO
	LIN	X	X	X	X	DPO3AUTO
	FlexRay	X	X	X	X	DPO3FLEX
Military and Aerospace	MIL-STD-1553	X	X	X	X	DPO3AERO
Audio	I ² S	X	X	X	X	DPO3AUDIO
	LJ, RJ	X	X	X	X	DPO3AUDIO
	TDM	X	X	X	X	DPO3AUDIO

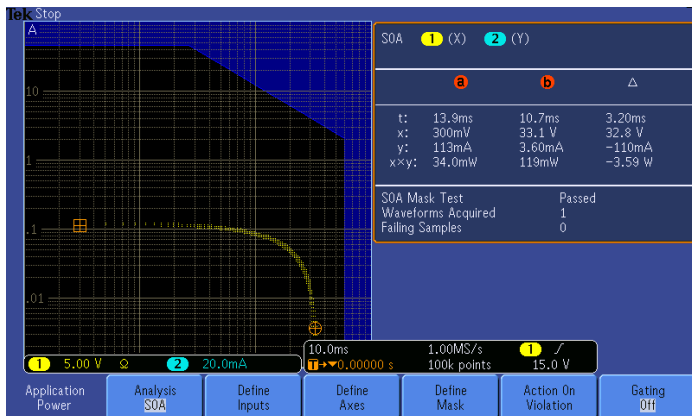

Safe operating area measurement. Automated power measurements enable quick and accurate analysis of common power parameters.

Power Analysis (Optional)

Ever increasing consumer demand for longer battery life devices and for green solutions that consume less power require power-supply designers to characterize and minimize switching losses to improve efficiency. In addition, the supply's power levels, output purity, and harmonic feedback into the power line must be characterized to comply with national and regional power quality standards. Historically, making these and many other power measurements on an oscilloscope has been a long, manual, and tedious process. The MSO/DPO3000 Series optional power analysis tools greatly simplify these tasks, enabling quick and accurate analysis of power quality, switching loss, harmonics, safe operating area (SOA), modulation, ripple, and slew rate (di/dt, dv/dt). Completely integrated into the oscilloscope, the power analysis tools provide automated, repeatable power measurements with a touch of a button; no external PC or complex software setup is required.

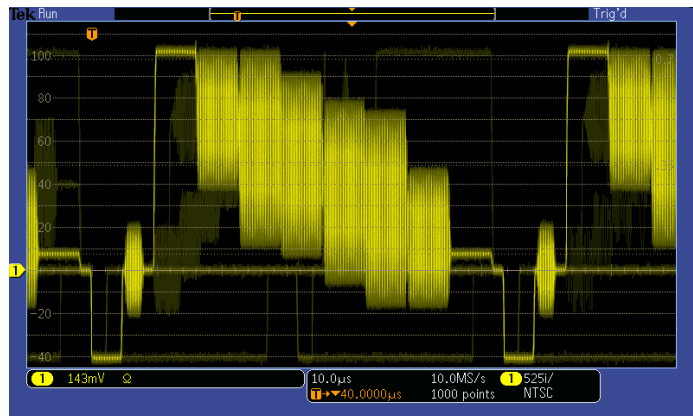

Viewing an NTSC video signal. Notice the intensity-graded view provided by the DPO's ability to represent time, amplitude, and distribution of amplitude over time.

Video Design and Development

Many video engineers have remained loyal to analog oscilloscopes, believing the intensity gradations on an analog display are the only way to see certain video waveform details. The MSO/DPO3000 Series fast waveform capture rate, coupled with its intensity-graded view of the signal, provides the same information-rich display as an analog oscilloscope, but with much more detail and all the benefits of digital scopes.

Standard features such as IRE and mV graticules, holdoff by fields, video polarity, and an Autoset smart enough to detect video signals, make the MSO/DPO3000 Series the easiest to use oscilloscope on the market for video applications. And with up to a 500 MHz bandwidth, four analog inputs, and a built-in 75 Ω input termination, the MSO/DPO3000 Series provides ample performance for analog and digital video use.

The MSO/DPO3000 Series video functionality is further extended with the optional DPO3VID video application module. DPO3VID provides the industry's most complete suite of HDTV and custom (nonstandard) video triggers.

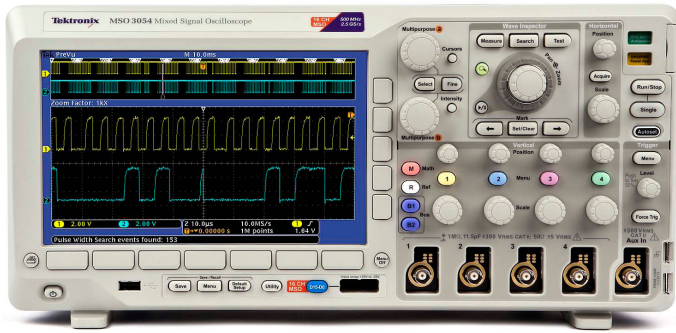

The MSO/DPO3000 is designed to make your work easier. The large, high-resolution display shows intricate signal details. Dedicated front-panel controls simplify operation. A USB host port on the front panel allows you to easily transfer screenshots, instrument settings, and waveform data to a memory stick.

Designed to Make Your Work Easier

Large, High-resolution Display

The MSO/DPO3000 Series features a 9 inch (229 mm) widescreen, high-resolution (800 × 480 WVGA) display for seeing intricate signal details.

Dedicated Front-panel Controls

Per-channel vertical controls provide simple and intuitive operation. No longer do you need to share one set of vertical controls across all four channels.

Connectivity

A USB host port on the front panel enables easy transfer of screenshots, instrument settings, and waveform data to a memory stick. The rear panel contains a second USB host port and a USB device port for controlling the oscilloscope remotely from a PC or for connecting a USB keyboard. The USB device port can also be used to print directly to a PictBridge®-compatible printer. An integrated 10/100 Ethernet port enables easy connection to networks and a Video Out port allows the oscilloscope display to be exported to an external monitor or projector.

Compact Form Factor

A compact, portable form factor allows the MSO/DPO3000 Series to be easily moved between labs and, with a depth of just 5.8 inches (147 mm), it saves you valuable space on your test bench.



The MSO/DPO3000 Series' compact form factor frees up valuable space on your bench or desktop.



TekVPI probe interface simplifies connecting your probes to the oscilloscope.

TekVPI® Probe Interface

The TekVPI probe interface sets the standard for ease of use in probing. TekVPI probes feature status indicators and controls, as well as a probe menu button right on the comp box itself. This button brings up a probe menu on the oscilloscope display with all relevant settings and controls for the probe. The TekVPI interface enables direct attachment of current probes without requiring a separate power supply. TekVPI probes can be controlled remotely through USB, GPIB, or Ethernet, enabling more versatile solutions in ATE environments.

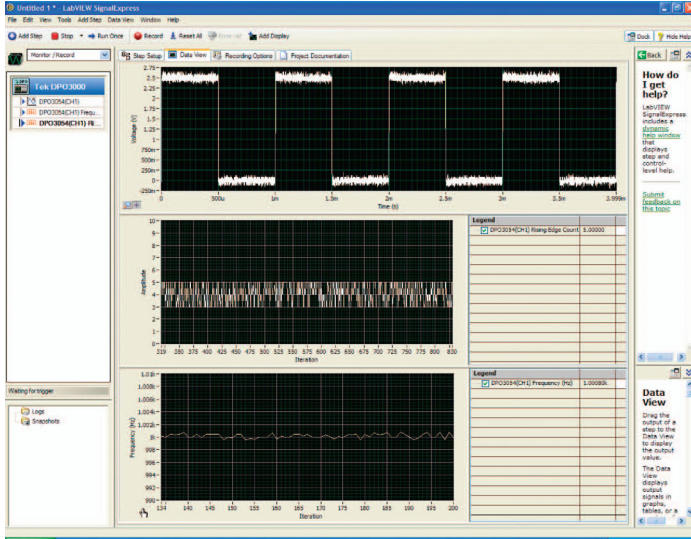

NI LabVIEW SignalExpress™ Tektronix Edition is a fully interactive measurement acquisition and analysis software developed jointly with National Instruments and optimized for the MSO/DPO Series.

Extended Analysis

Acquiring data and measurements from the MSO/DPO3000 Series is as simple as connecting a USB cable from the oscilloscope to your PC. Key software applications – NI LabVIEW SignalExpress™ Tektronix Edition LE, OpenChoice® Desktop, and Microsoft Excel and Word toolbars – are included standard with each oscilloscope to enable fast and easy direct communication with your Windows PC.

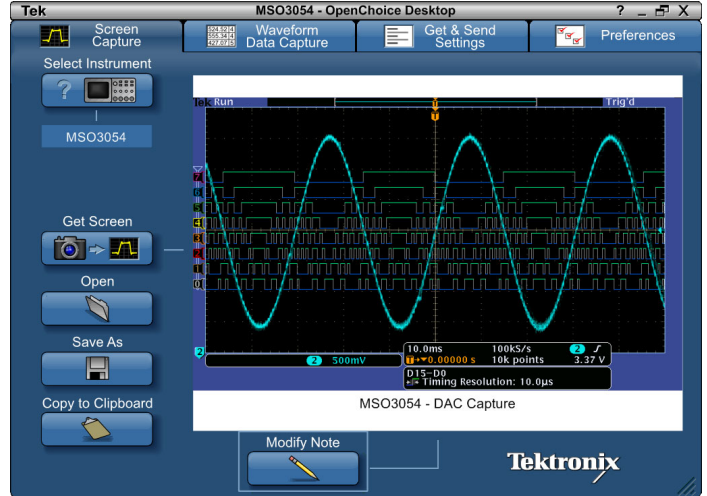

OpenChoice® Desktop software enables seamless connection between the oscilloscope and your PC.

NI LabVIEW SignalExpress Tektronix Edition LE enables you to instantly acquire, generate, analyze, compare, import, and save measurement data and signals using an intuitive drag-and-drop user interface that does not require any programming. The optional Professional Version offers over 200 built-in functions that provide additional signal processing, advanced analysis, sweeping, limit testing and user-defined step capabilities.

For simple tasks, the included OpenChoice Desktop enables fast and easy communication between the oscilloscope and your PC through USB or LAN for transferring settings, waveforms, and screen images.

Characteristics

Vertical System Analog Channels

Characteristic	MSO3012 DPO3012	MSO3014 DPO3014	MSO3032 DPO3032	MSO3034 DPO3034	DPO3052	MSO3054 DPO3054
Input Channels	2	4	2	4	2	4
Analog Bandwidth (-3 dB)	100 MHz	100 MHz	300 MHz	300 MHz	500 MHz	500 MHz
Calculated Rise Time 5 mV/div (typical)	3.5 ns	3.5 ns	1.17 ns	1.17 ns	700 ps	700 ps
Hardware Bandwidth Limits	20 MHz		20 MHz, 150 MHz			
Input Coupling	AC, DC, GND					
Input Impedance	1 M Ω \pm 1%, 75 Ω \pm 1%, 50 Ω \pm 1%					
Input Sensitivity Range, 1 M Ω	1 mV/div to 10 V/div					
Input Sensitivity Range, 75 Ω , 50 Ω	1 mV/div to 1 V/div					
Vertical Resolution	8 bits (11 bits with Hi Res)					
Maximum Input Voltage, 1 M Ω	300 V _{RMS} with peaks \leq \pm 450 V					
Maximum Input Voltage, 75 Ω , 50 Ω	5 V _{RMS} with peaks \leq \pm 20 V					
DC Gain Accuracy	\pm 1.5% for 5 mV/div and above \pm 2.0% for 2 mV/div \pm 2.5% for 1 mV/div					
Channel-to-Channel Isolation (Any Two Channels at Equal Vertical Scale)	\geq 100:1 at \leq 100 MHz and \geq 30:1 at $>$ 100 MHz up to the rated BW					

Offset Range

Range	1 M Ω	50 Ω , 75 Ω
1 mV/div to 99.5 mV/div	\pm 1 V	\pm 1 V
100 mV/div to 995 mV/div	\pm 10 V	\pm 5 V
1 V/div	\pm 100 V	\pm 5 V
1.01 V/div to 10 V/div	\pm 100 V	NA

Vertical System Digital Channels

Characteristic	All MSO3000 Models
Input Channels	16 Digital (D15 to D0)
Thresholds	Threshold per set of 8 channels
Threshold Selections	TTL, CMOS, ECL, PECL, User Defined
User-defined Threshold Range	-15 V to +25 V
Maximum Input Voltage	-20 V to +30 V
Threshold Accuracy	\pm (100 mV +3% of threshold setting)
Maximum Input Dynamic Range	50 V _{pp} (threshold setting dependent)
Minimum Voltage Swing	500 mV _{pp}
Input Impedance	101 k Ω
Probe Loading	8 pF
Vertical Resolution	1 bit

Horizontal System Analog Channels

Characteristic	All MSO3000 Models All DPO3000 Models
Maximum Sample Rate (all channels)	2.5 GS/s
Maximum Record Length (all channels)	5 Mpoints
Maximum Duration of Time Captured at Highest Sample Rate (all channels)	2 ms
Time-base Range (s/div)	1 ns to 1000 s
Time-base Delay Time Range	-10 divisions to 5000 s
Channel-to-Channel Deskew Range	\pm 100 ns
Time-base Accuracy	\pm 10 ppm over any \geq 1 ms interval

Horizontal System Digital Channels

Characteristic	All MSO3000 Models
Maximum Sample Rate (Main, all channels)	500 MS/s (2 ns resolution)
Maximum Record Length (Main, all channels)	5 Mpoints
Maximum Sample Rate (MagniVu, all channels)	8.25 GS/s (121.2 ps resolution)
Maximum Record Length (MagniVu, all channels)	10 kpoints centered on the trigger
Minimum Detectable Pulse Width	2.0 ns
Channel-to-Channel Skew	500 ps typical

Trigger System

Characteristic	Description
Main Trigger Modes	Auto, Normal, and Single
Trigger Coupling	DC, AC, HF reject (attenuates >50 kHz), LF reject (attenuates <50 kHz), noise reject (reduces sensitivity)
Trigger Holdoff Range	20 ns to 8 s

Trigger Sensitivity

Characteristic	Description
Internal DC Coupled	0.5 div from DC to 50 MHz, increasing to 1 div at rated bandwidth
External (Auxiliary Input)	200 mV from DC to 50 MHz increasing to 500 mV at 250 MHz

Trigger Level Range

Characteristic	Description
Any Channel	±8 divisions from center of screen
External (Auxiliary Input)	±8 V

Trigger Modes

Mode	Description
Edge	Positive or negative slope on any channel or front-panel auxiliary input. Coupling includes DC, AC, HF reject, LF reject, and noise reject.
Sequence (B-trigger)	Trigger Delay by Time – 8 ns to 8 s. Or Trigger Delay by Events – 1 to 9,999,999 events.
Pulse Width	Trigger on positive or negative pulses that are <, >, =, ≠ a specified time. Additionally, you can trigger when a pulse width is within or outside a range of two different specified times.
Timeout	Trigger when no pulse is detected within a specified time (4 ns to 8 s).
Runt	Trigger on a pulse that crosses one threshold but fails to cross a second threshold before crossing the first again.
Logic	Trigger when any logical pattern of channels goes false or stays true for specified period of time. Any input can be used as a clock to look for the pattern on a clock edge. Pattern (AND, OR, NAND, NOR) specified for all analog and digital input channels defined as High, Low, or Don't Care.
Setup and Hold	Trigger on violations of both setup time and hold time between clock and data present on any of the input channels.
Rise/Fall Time	Trigger on pulse edge rates that are faster or slower than specified. Slope may be positive, negative, or either.
Video	Trigger on all lines, odd, even, or all fields on NTSC, PAL, and SECAM video signals.
Extended Video (optional)	Trigger on 480p/60, 576p/50, 720p/30, 720p/50, 720p/60, 875i/60, 1080i/50, 1080i/60, 1080p/24, 1080p/24sF, 1080p/25, 1080p/30, 1080p/50, 1080p/60, and custom bi-level and tri-level sync video standards.
I ² C (optional)	Trigger on Start, Repeated Start, Stop, Missing ACK, Address (7 or 10 bit), Data, or Address and Data on I ² C buses up to 10 Mb/s.
SPI (optional)	Trigger on SS, MOSI, MISO, or MOSI and MISO on SPI buses up to 10.0 Mb/s.
MIL-STD-1553 (optional)	Trigger on Sync, Word Type*1 (Command, Status, Data), Command Word*1 (set RT Address, T/R, Sub-address/Mode, Data Word Count/Mode Code, and Parity individually), Status Word*1 (set RT Address, Message Error, Instrumentation, Service Request Bit, Broadcast Command Received, Busy, Subsystem Flag, Dynamic Bus Control Acceptance (DBCA), Terminal Flag, and Parity individually), Data Word (user-specified 16-bit data value), Error (Sync, Parity, Manchester, Non-contiguous data), Idle Time (minimum time selectable from 4 μs to 100 μs; maximum time selectable from 12 μs to 100 μs; trigger on < minimum, > maximum, inside range, outside range). RT Address can be further specified to trigger on =, ≠, <, >, ≤, ≥ a particular value, or inside or outside of a range.
CAN (optional)	Trigger on Start of Frame, Frame Type (data, remote, error, overload), Identifier (standard or extended), Data, Identifier and Data, End of Frame, Missing ACK, or Bit Stuffing Error on CAN signals up to 1 Mb/s. Data can be further specified to trigger on ≤, <, =, >, ≥, or ≠ a specific data value. User-adjustable sample point is set to 50% by default.
I ² S/LJ/RJ/TDM (optional)	Trigger on Word Select, Frame Sync, or Data. Data can be further specified to trigger on ≤, <, =, >, ≥, ≠ a specific data value, or inside or outside of a range. Maximum data rate for I ² S/LJ/RJ is 12.5 Mb/s. Maximum data rate for TDM is 25 Mb/s.
RS-232/422/485/UART (optional)	Trigger on Tx Start Bit, Rx Start Bit, Tx End of Packet, Rx End of Packet, Tx Data, Rx Data, Tx Parity Error, and Rx Parity Error up to 10 Mb/s.
LIN (optional)	Trigger on Sync, Identifier, Data, Identifier and Data, Wakeup Frame, Sleep Frame, Errors such as Sync, Parity, or Checksum Errors up to 1 Mb/s (by LIN definition, 20 kb/s).
FlexRay (optional)	Trigger on Start of Frame, Type of Frame (Normal, Payload, Null, Sync, Startup), Identifier, Cycle Count, Complete Header Field, Data, Identifier and Data, End of Frame, or Errors such as Header CRC, Trailer CRC, Null Frame, Sync Frame, or Startup Frame Errors up to 10 Mb/s.
Parallel (available on MSO models only)	Trigger on a parallel bus data value. Parallel bus can be from 1 to 16 bits in size. Binary and Hex radices are supported.

*1 Trigger selection of Command Word will trigger on Command and ambiguous Command/Status words. Trigger selection of Status Word will trigger on Status and ambiguous Command/Status words.

Acquisition Modes

Mode	Description
Sample	Acquire sampled values.
Peak Detect	Captures glitches as narrow as 2 ns at all sweep speeds.
Averaging	From 2 to 512 waveforms included in average.
Envelope	Min-max envelope reflecting Peak Detect data over multiple acquisitions.
Hi Res	Real-time boxcar averaging reduces random noise and increases vertical resolution.
Roll	Scrolls waveforms right to left across the screen at sweep speeds slower than or equal to 40 ms/div.

Waveform Measurements

Measurement	Description
Cursors	Waveform and Screen.
Automatic Measurements	29, of which up to four can be displayed on-screen at any one time. Measurements include: Period, Frequency, Delay, Rise Time, Fall Time, Positive Duty Cycle, Negative Duty Cycle, Positive Pulse Width, Negative Pulse Width, Burst Width, Phase, Positive Overshoot, Negative Overshoot, Peak to Peak, Amplitude, High, Low, Max, Min, Mean, Cycle Mean, RMS, Cycle RMS, Positive Pulse Count, Negative Pulse Count, Rising Edge Count, Falling Edge Count, Area and Cycle Area.
Measurement Statistics	Mean, Min, Max, Standard Deviation.
Reference Levels	User-definable reference levels for automatic measurements can be specified in either percent or units.
Gating	Isolate the specific occurrence within an acquisition to take measurements on, using either the screen, or waveform cursors.

Power Measurements (Optional)

Measurement	Description
Power Quality Measurements	V_{RMS} , $V_{Crest\ Factor}$, Frequency, I_{RMS} , $I_{Crest\ Factor}$, True Power, Apparent Power, Reactive Power, Power Factor, Phase Angle.
Switching Loss Measurements	Power Loss: T_{on} , T_{off} , Conduction, Total. Energy Loss: T_{on} , T_{off} , Conduction, Total.
Harmonics	THD-F, THD-R, RMS measurements. Graphical and table displays of harmonics. Test to IEC61000-3-2 Class A and MIL-STD-1399.
Ripple Measurements	V_{ripple} and I_{ripple} .
Modulation Analysis	Graphical display of +Pulse Width, -Pulse Width, Period, Frequency, +Duty Cycle, and -Duty Cycle modulation types.
Safe Operating Area	Graphical display and mask testing of switching device safe operating area measurements.
dV/dt and dI/dt Measurements	Cursor measurements of slew rate.

Waveform Math

Characteristic	Description
Arithmetic	Add, subtract, multiply, and divide waveforms.
Math Functions	Integrate, Differentiate, FFT.
FFT	Spectral magnitude. Set FFT Vertical Scale to Linear RMS or dBV RMS, and FFT Window to Rectangular, Hamming, Hanning, or Blackman-Harris.
Advanced Math	Define extensive algebraic expressions including waveforms, reference waveforms, math functions (FFT, Intg, Diff, Log, Exp, Sqrt, Sine, Cosine, Tangent), scalars, up to two user-adjustable variables and results of parametric measurements (Period, Freq, Delay, Rise, Fall, PosWidth, NegWidth, BurstWidth, Phase, PosDutyCycle, NegDutyCycle, PosOverShoot, NegOverShoot, PeakPeak, Amplitude, RMS, CycleRMS, High, Low, Max, Min, Mean, CycleMean, Area, CycleArea, and trend plots), e.g., (Intg(Ch1 - Mean(Ch1)) × 1.414 × VAR1).

Software

Product	Description
NI LabVIEW SignalExpress™ Tektronix Edition	A fully interactive measurement software environment optimized for the MSO/DPO3000 Series, enables you to instantly acquire, generate, analyze, compare, import, and save measurement data and signals using an intuitive drag-and-drop user interface that does not require any programming. Standard MSO/DPO3000 Series support for acquiring, controlling, viewing, and exporting your live signal data is permanently available through the software. The full version (SIGEXPTE) adds additional signal processing, advanced analysis, mixed signal, sweeping, limit testing, and user-defined step capabilities and is available for a 30-day trial period standard with each instrument.
OpenChoice® Desktop	Enables fast and easy communication between a Windows PC and the MSO/DPO3000 Series. Transfer and save settings, waveforms, measurements, and screen images. Included Word and Excel toolbars automate the transfer of acquisition data and screen images from the oscilloscope into Word and Excel for quick reporting or further analysis.
IVI Driver	Provides a standard instrument programming interface for common applications such as LabVIEW, LabWindows/CVI, Microsoft .NET, and MATLAB.
eScope	Enables control of the MSO/DPO3000 Series over a network connection through a standard web browser. Simply enter the IP address or network name of the oscilloscope and a web page will be served to the browser.

Display Characteristics

Characteristic	Description
Display Type	9 in. (228.6 mm) wide format liquid crystal TFT color display.
Display Resolution	800 horizontal × 480 vertical pixels (WVGA).
Waveform Styles	Vectors, Dots, Variable Persistence, Infinite Persistence.
Graticules	Full, Grid, Cross Hair, Frame, IRE and mV.
Format	YT and XY.
Maximum Waveform Capture Rate	>50,000 wfm/s.

Input/Output Ports

Port	Description
USB 2.0 High-speed Host Port	Supports USB mass storage devices, printers, and keyboards. One port available on rear panel and one on front panel.
USB 2.0 High-speed Device Port	Rear-panel connector allows for communication/control of oscilloscope through USBTMC or GPIB with a TEK-USB-488, and direct printing to all PictBridge®-compatible printers.
LAN Port	RJ-45 connector, supports 10/100BASE-T.
Video Out Port	DB-15 female connector, connect to show the oscilloscope display on an external monitor or projector.
Auxiliary Input	Front-panel BNC connector. Input Impedance 1 MΩ. Max input 300 V _{RMS} CAT II with peaks ≤ ±450 V.
Probe Compensator Output	Front-panel pins Amplitude: 2.5 V Frequency: 1 kHz
Trigger Out	Rear-panel BNC connector, provides a negative-polarity pulse when the oscilloscope triggers.
Kensington Style Lock	Rear-panel security slot connects to standard Kensington-style lock.

Power Source

Characteristic	Description
Power Source Voltage	85 to 265 V ±10%
Power Source Frequency	45 to 440 Hz (85 to 265 V)
Power Consumption	120 W maximum
Optional TekVPI® External Power Supply*2	Output Voltage: 12 V Output Current: 5 A Power Consumption: 50 W

*2 Required when total oscilloscope probe power usage exceeds 20 W.

Physical Characteristics

Dimensions	mm	in.
Height	203.2	8
Width	416.6	16.4
Depth	147.3	5.8
Weight	kg	lb.
Net	4.17	9.2
Shipping	8.62	19
Rackmount Configuration	5U	
Cooling Clearance	2 in. (51 mm) required on left side and rear of instrument	

Environmental

Characteristic	Description
Temperature	
Operating	0 °C to +50 °C
Nonoperating	-40 °C to +71 °C
Humidity	
Operating	High: 30 °C to 50 °C, 5% to 45% Relative Humidity Low: 0 °C to 30 °C, 5% to 95% Relative Humidity
Nonoperating	High: 30 °C to 50 °C, 5% to 45% Relative Humidity Low: 0 °C to 30 °C, 5% to 95% Relative Humidity
Altitude	
Operating	3,000 meters (9,843 feet)
Nonoperating	12,000 meters (39,370 feet)
Random Vibration	
Operating	0.31 G _{RMS} from 5 to 500 Hz, 10 minutes each axis, 3 axes, 30 minutes total
Nonoperating	2.46 G _{RMS} from 5 to 500 Hz, 10 minutes each axis, 3 axes, 30 minutes total
Regulatory	
Electromagnetic Compatibility	EC Council Directive 2004/108/EC
Safety	UL61010-1:2004; CAN/CSA C22.2 No. 61010.1-04; EN61010-1:2001; IEC61010-1:2001

Ordering Information

DPO3000 Models

Product	Description
DPO3012	100 MHz, 2.5 GS/s, 5M record length, 2-channel digital phosphor oscilloscope
DPO3014	100 MHz, 2.5 GS/s, 5M record length, 4-channel digital phosphor oscilloscope
DPO3032	300 MHz, 2.5 GS/s, 5M record length, 2-channel digital phosphor oscilloscope
DPO3034	300 MHz, 2.5 GS/s, 5M record length, 4-channel digital phosphor oscilloscope
DPO3052	500 MHz, 2.5 GS/s, 5M record length, 2-channel digital phosphor oscilloscope
DPO3054	500 MHz, 2.5 GS/s, 5M record length, 4-channel digital phosphor oscilloscope

MSO3000 Models

Product	Description
MSO3012	100 MHz, 2.5 GS/s, 5M record length, 2+16 channel mixed-signal oscilloscope
MSO3014	100 MHz, 2.5 GS/s, 5M record length, 4+16 channel mixed-signal oscilloscope
MSO3032	300 MHz, 2.5 GS/s, 5M record length, 2+16 channel mixed-signal oscilloscope
MSO3034	300 MHz, 2.5 GS/s, 5M record length, 4+16 channel mixed-signal oscilloscope
MSO3054	500 MHz, 2.5 GS/s, 5M record length, 4+16 channel mixed-signal oscilloscope

All Models Include: One P6139B 500 MHz, 10X Passive Probe per Analog Channel, Front Cover (200-5052-xx), User Manual, Documentation CD (063-4104-xx), OpenChoice® Desktop Software, NI LabVIEW SignalExpress™ Tektronix Edition LE Software, Calibration Certificate Documenting Traceability to National Metrology Institute(s) and ISO9001 Quality System Registration, Power Cord, Accessory Pouch (016-2008-xx), Three-year Warranty. Please specify power plug and manual language version when ordering.

MSO Models also Include: One P6316 16-channel logic probe and accessory kit.

Application Modules

Application modules have licenses which can be transferred between an application module and an oscilloscope. The license may be contained in the module; allowing the module to be moved from one instrument to another. Or, the license can be contained in the oscilloscope; allowing the module to be removed and stored for safekeeping. Transferring the license to an oscilloscope and removing the module permits the use of more than 4 applications simultaneously.

Modules	Description
DPO3AERO	<p>Aerospace Serial Triggering and Analysis Module. Enables triggering on packet-level information on MIL-STD-1553 buses as well as analytical tools such as digital views of the signal, bus views, packet decoding, search tools, and packet decode tables with time-stamp information.</p> <p>Signal Inputs – Any Ch1 - Ch4, Math, Ref1 - Ref4</p> <p>Recommended Probing – Differential or single ended (only one single-ended signal required)</p>
DPO3AUDIO	<p>Audio Serial Triggering and Analysis Module. Enables triggering on packet-level information on I²S, Left Justified (LJ), Right Justified (RJ), TDM, and custom audio buses, as well as analytical tools such as digital views of the signal, bus views, packet decoding, search tools, and packet decode tables with time-stamp information.</p> <p>Signal Inputs – Any Ch1 - Ch4 (and any D0 - D15 on MSO models)</p> <p>Recommended Probing – Single ended</p>
DPO3AUTO	<p>Automotive Serial Triggering and Analysis Module. Enables triggering on packet-level information on CAN and LIN buses as well as analytical tools such as digital views of the signal, bus views, packet decoding, search tools, and packet decode tables with time-stamp information.</p> <p>Signal Inputs – LIN: Any Ch1 - Ch4 (and any D0 - D15 on MSO models); CAN: Any Ch1 - Ch4 (and any D0 - D15 on MSO models; single-ended probing only)</p> <p>Recommended Probing – LIN: Single ended; CAN: Single ended or differential</p>
DPO3COMP	<p>Computer Serial Triggering and Analysis Module. Enables triggering on packet-level information on RS-232/422/485/UART buses as well as analytical tools such as digital views of the signal, bus views, packet decoding, search tools, and packet decode tables with time-stamp information.</p> <p>Signal Inputs – Any Ch1 - Ch4 (and any D0 - D15 on MSO models; single-ended probing only)</p> <p>Recommended Probing – RS-232/UART: Single ended; RS-422/485: Differential</p>

Modules	Description
DPO3EMBD	<p>Embedded Serial Triggering and Analysis Module. Enables triggering on packet-level information on I²C and SPI buses as well as analytical tools such as digital views of the signal, bus views, packet decoding, search tools, and packet decode tables with time-stamp information. Only two-wire SPI support available on DPO3012, DPO3032, and DPO3052 models.</p> <p>Signal Inputs – I²C: Any Ch1 - Ch4 (and any D0 - D15 on MSO models); SPI: Any Ch1 - Ch4 (and any D0 - D15 on MSO models)</p> <p>Recommended Probing – I²C, SPI: Single ended</p>
DPO3FLEX	<p>FlexRay Serial Triggering and Analysis Module. Enables triggering on packet-level information on FlexRay buses as well as analytical tools such as digital views of the signal, bus views, packet decoding, search tools, packet decode tables with time-stamp information.</p> <p>Signal Inputs – Any Ch1 - Ch4 (and any D0 - D15 on MSO models; single-ended probing only)</p> <p>Recommended Probing – Single ended or differential</p>
DPO3PWR	<p>Power Analysis Module. Enables quick and accurate analysis of power quality, switching loss, harmonics, safe operating area (SOA), modulation, ripple, and slew rate (di/dt, dV/dt).</p>
DPO3VID	<p>HDTV and Custom (nonstandard) Video Triggering Module.</p>

Bandwidth Upgrades

Bandwidth is fully upgradable (up to 500 MHz) on an MSO/DPO3000 Series oscilloscope.*³

Option	Description
DPO3BW1T32	Bandwidth upgrade from 100 MHz to 300 MHz for a MSO/DPO3012
DPO3BW1T34	Bandwidth upgrade from 100 MHz to 300 MHz for a MSO/DPO3014
DPO3BW1T52	Bandwidth upgrade from 100 MHz to 500 MHz for a MSO/DPO3012
DPO3BW1T54	Bandwidth upgrade from 100 MHz to 500 MHz for a MSO/DPO3014
DPO3BW3T52	Bandwidth upgrade from 300 MHz to 500 MHz for a MSO/DPO3012 or MSO/DPO3032
DPO3BW3T54	Bandwidth upgrade from 300 MHz to 500 MHz for a MSO/DPO3014 or MSO/DPO3034

³ Instruments with serial numbers starting with C02 or B02 are upgraded with a software option key. Instruments with serial numbers starting with C01 or B01 must be upgraded at an authorized Tektronix service center.

Instrument Options

Power Plug Options

Option	Description
Opt. A0	North America
Opt. A1	Universal Euro
Opt. A2	United Kingdom
Opt. A3	Australia
Opt. A5	Switzerland
Opt. A6	Japan
Opt. A10	China
Opt. A11	India
Opt. A12	Brazil
Opt. A99	No power cord

Language Options*⁴

Option	Description
Opt. L0	English manual
Opt. L1	French manual
Opt. L2	Italian manual
Opt. L3	German manual
Opt. L4	Spanish manual
Opt. L5	Japanese manual
Opt. L6	Portuguese manual
Opt. L7	Simplified Chinese manual
Opt. L8	Traditional Chinese manual
Opt. L9	Korean manual
Opt. L10	Russian manual
Opt. L99	No manual

*⁴ Language options include translated front-panel overlay for the selected language(s).

Service Options*⁵

Option	Description
Opt. CA1	Provides a single calibration event, or coverage for the designated calibration interval, whichever comes first.
Opt. D1	Calibration Data Report.
Opt. R5	Repair Service 5 years (including warranty).
Opt. SILV400	Standard Warranty Extended to 5 Years

*⁵ Probes and accessories are not covered by the oscilloscope warranty and Service Offerings. Refer to the datasheet of each probe and accessory model for its unique warranty and calibration terms.

Recommended Probes

Probe	Description
TAP1500	1.5 GHz TekVPI® active voltage probe
TAP1500X2	Bundle of Two 1.5 GHz Active Probes, single ended with TekVPI Interface
TDP0500	500 MHz TekVPI differential voltage probe with ± 42 V differential input voltage
TDP1000	1 GHz TekVPI differential voltage probe with ± 42 V differential input voltage
TMDP0200	± 750 V, 200 MHz high-voltage differential probe
THDP0200	± 1.5 kV, 200 MHz high-voltage differential probe
THDP0100	± 6 kV, 100 MHz high-voltage differential probe
TCP0030	120 MHz TekVPI 30 Ampere AC/DC current probe
TCP0150	20 MHz TekVPI 150 Ampere AC/DC current probe
TCPA300/400*6	Current measurement systems amplifier
P5100A	2.5 kV, 500 MHz, 100X high-voltage passive probe
ADA400A*6	100X, 10X, 1X, 0.1X high-gain differential amplifier
NEX-HD2HEADER	Mictor connector breakout to 0.1 in. header pins

*6 Requires TekVPI® to TekProbe BNC adapter (TPA-BNC).

Recommended Accessories

Accessory	Description
071-2667-xx	Service Manual (English only)
TPA-BNC	TekVPI to TekProbe BNC adapter
TEK-DPG	TekVPI Deskew Pulse Generator Signal Source
067-1686-xx	Power Measurement Deskew and Calibration Fixture
119-7465-xx*7	TekVPI® External Power Supply
SIGEXPT	NI LabVIEW SignalExpress Tektronix Edition Software – Full Version
FPGAView-xx	MSO Support for Altera and Xilinx FPGAs
TEK-USB-488	GPIO to USB adapter
ACD4000	Soft Transit Case
HCTEK4321	Hard Transit Case (requires ACD4000)
RMD3000	Rackmount Kit

*7 Required when total oscilloscope probe power usage exceeds 20 W. Power cord not included.

Warranty

Three-year warranty covering all parts and labor, excluding probes.



Tektronix is registered to ISO 9001 and ISO 14001 by SRI Quality System Registrar.



Product(s) complies with IEEE Standard 488.1-1987, RS-232-C, and with Tektronix Standard Codes and Formats.

Contact Tektronix:

ASEAN / Australasia (65) 6356 3900
Austria 00800 2255 4835*
Balkans, Israel, South Africa and other ISE Countries +41 52 675 3777
Belgium 00800 2255 4835*
Brazil +55 (11) 3759 7627
Canada 1 800 833 9200
Central East Europe and the Baltics +41 52 675 3777
Central Europe & Greece +41 52 675 3777
Denmark +45 80 88 1401
Finland +41 52 675 3777
France 00800 2255 4835*
Germany 00800 2255 4835*
Hong Kong 400 820 5835
India 000 800 650 1835
Italy 00800 2255 4835*
Japan 81 (3) 6714 3010
Luxembourg +41 52 675 3777
Mexico, Central/South America & Caribbean 52 (55) 56 04 50 90
Middle East, Asia, and North Africa +41 52 675 3777
The Netherlands 00800 2255 4835*
Norway 800 16098
People's Republic of China 400 820 5835
Poland +41 52 675 3777
Portugal 80 08 12370
Republic of Korea 001 800 8255 2835
Russia & CIS +7 (495) 7484900
South Africa +41 52 675 3777
Spain 00800 2255 4835*
Sweden 00800 2255 4835*
Switzerland 00800 2255 4835*
Taiwan 886 (2) 2722 9622
United Kingdom & Ireland 00800 2255 4835*
USA 1 800 833 9200

* European toll-free number. If not accessible, call: +41 52 675 3777

Updated 10 February 2011

For Further Information. Tektronix maintains a comprehensive, constantly expanding collection of application notes, technical briefs and other resources to help engineers working on the cutting edge of technology. Please visit www.tektronix.com



Copyright © Tektronix, Inc. All rights reserved. Tektronix products are covered by U.S. and foreign patents, issued and pending. Information in this publication supersedes that in all previously published material. Specification and price change privileges reserved. TEKTRONIX and TEK are registered trademarks of Tektronix, Inc. All other trade names referenced are the service marks, trademarks, or registered trademarks of their respective companies.

25 Jul 2012

3GW-21364-9

