

AQ1200 MFT-OTDR

MULTI FIELD TESTER OTDR

All-in-One
handheld optical fiber network test tool



NEW LINE UP

3 Wavelength Model and High Dynamic Range Model

QUALITY ■ INNOVATION ■ FORESIGHT

www.tmi.yokogawa.com

Test & Measurement Instruments

Multifunctional Handheld OTDR

Offering Powerful Test Features & Excellent Operability

MULTI FIELD TESTER MFT-OTDR AQ1200

Compact chassis yet fully equipped with field testing functions

The AQ1200 Multi Field Tester OTDR is a compact and lightweight handheld OTDR optimized for the installation and maintenance of optical fiber cables. Designed with ease of use in mind to simplify field testing, improve work efficiency and ensure quality results. Seven models are offered, each with unique wavelength(s) based on their specific application.

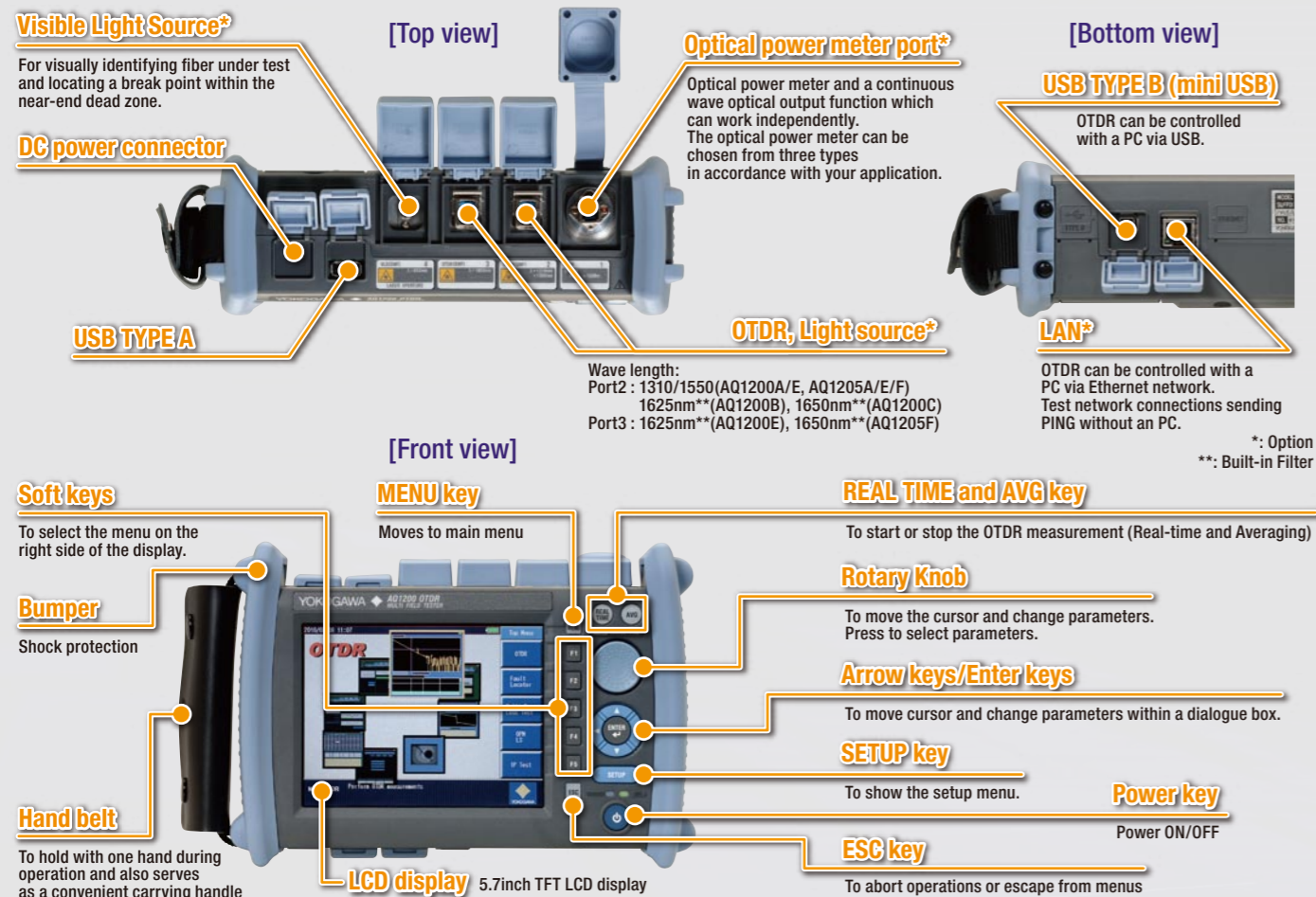

Product Lineup

AQ1200A	1310/1550 nm	Standard model with the same wavelengths used for communication services. Applicable for installation and maintenance
AQ1200B	1625 nm	Models with a wavelength dedicated for maintenance of live fibers. A built-in cut filter isolates the maintenance wavelength from the communication wavelength in order to perform accurate measurements in live networks.
AQ1200C	1650 nm	
NEW AQ1200E	1310/1550 nm 1625 nm	These tri-wavelength models has two ports. One port offers the communication wavelengths while the other port is dedicated for the maintenance wavelength. Thus this model is ideal for use in both installation and maintenance applications.
NEW AQ1205A	1310/1550 nm	This High dynamic range model can accurately measure the trace even after the splitter in a PON system. Thus this standard wavelength model is highly suited for high port count PON networks with up to 64 ports splitters.
NEW AQ1205E	1310/1550 nm 1625 nm	These tri-wavelength models offers high dynamic range and has two ports. One port offers the communication wavelengths while the other port is dedicated for the maintenance wavelength. Thus this model is ideal for use in both installation and maintenance applications.
NEW AQ1205F	1310/1550 nm 1650 nm	The high dynamic range feature can accurately measure the trace even after the splitter in a PON system. Thus this is highly suited for high port count PON networks with up to 64 ports splitters.

*: Please make sure that the measurement signal does not affect the communication services before use, by implementing a measurement wavelength cut filter in the line under test or otherwise.

PON Measurement Capability

In Passive Optical Network (PON) System used in FTTH (Fiber To The Home) it is important to quickly and correctly find a fault in the drop cable that is installed after the splitter.

The AQ1200 MFT OTDR's PON measurement mode (*) is a mode optimized for the measurement of PON with a high-port-count optical splitter and can ensure a quality waveform even if there is a big loss of optical splitter in the line.

With a short dead zone, the AQ1200 can distinguish connectors placed as closely as 0.75 m in FTTx, home or office networks.

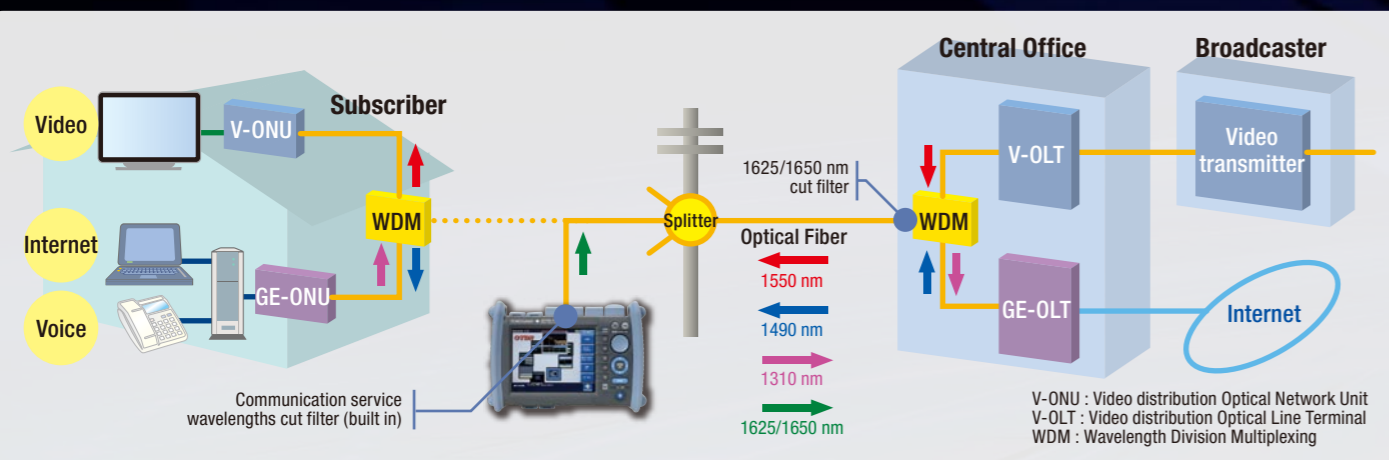

• Example of measurement over a 64 port splitter

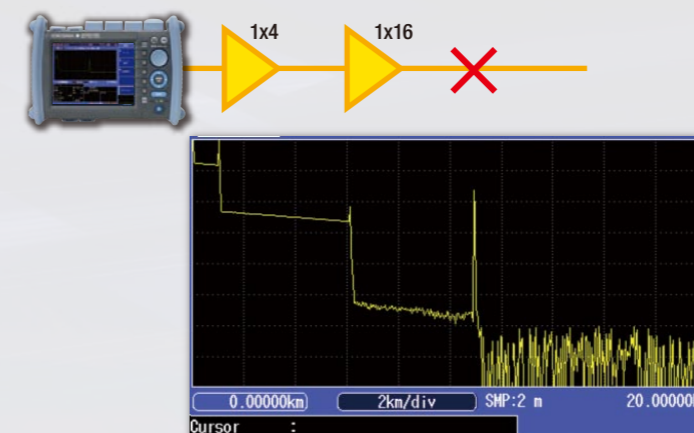

• Event dead zone 0.75 m

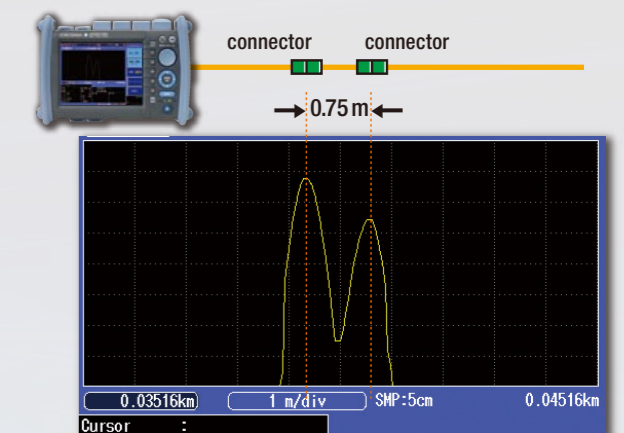

NEW Fault locator



Find a fiber break point easily and rapidly

Pressing one button initiates a measurement and event search and then clearly indicates the location of a fiber break. Waveform analysis can be done by simply switching over to OTDR function.

Select the Structure



Fault locator screen

In-depth waveform analysis



Waveform analysis screen of OTDR function

Light Source & Optical Powermeter

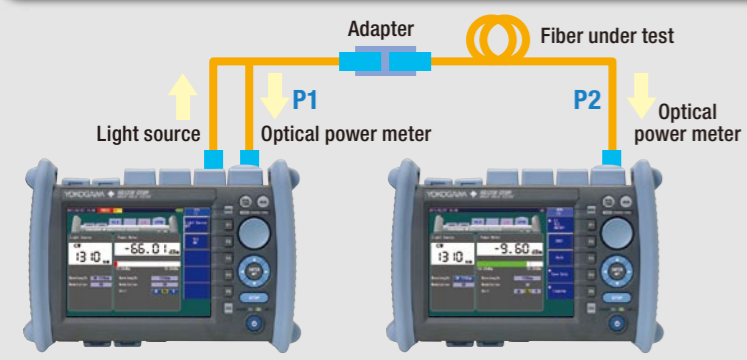

Manual Loss test using light source & optical powermeter *1,*2

After adjusting the optical output power (P1) at the end of launch fiber, measure the output power of fiber under test (P2).

Total fiber loss = P1 - P2 (dB)

High power measurement *2

Allow to measure the high power output of optical amplifier, which is used for video services, such as CATV, and long distance transmission.

*1 : /SLT option is required to use this function. *2 : /HLT option is required to use this function.

Auto Loss Test*

Loss measurement with LS & OPM interlock

AQ1200's light source can transmit wavelength information, so that AQ1200's optical powermeter can make measurements at a right wavelength at the other end. Moreover, the AQ1200A's light source and optical powermeter can switch between two wavelengths (1310 and 1550 nm) automatically; therefore, the optical powermeter can make measurements at right wavelengths, changing the wavelength along with the light source.

Measurement result storage and report output

Measurement results can be saved in the internal storage or external USB storage media, and the measurement report can be generated in CSV format.

* : /SLT or /HLT option is required to use this function.

Multicore Loss Test*

Work as Master & Slave using the communication fiber

The master unit can share the project information such as the core number table and measurement conditions with the slave unit by sending them through the communication fiber in the cable under test.

* : /SLT or /HLT option is required to use this function.

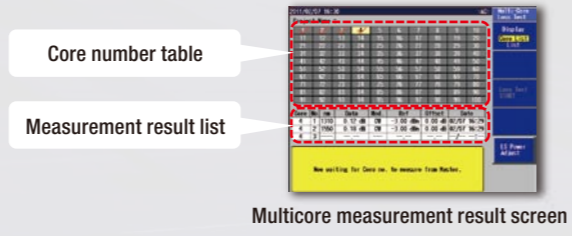

Core number table

Measurement result list

Multicore measurement result screen

PON Optical Powermeter*

Simultaneous 1490 & 1550 nm measurement

The PON power meter can measure the optical power both at 1490 nm and at 1550 nm simultaneously by separating those wavelengths.

Suitable tool for measuring the optical power of OLT and V-OLT.

* : /PPM option is required to use this function.

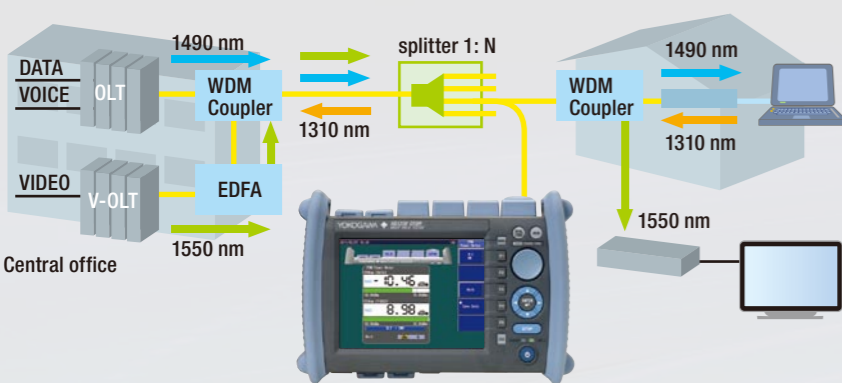

Optical power at 1490 nm

Optical power at 1550 nm



PON optical powermeter screen

NEW Trace Analysis Functions

For Evaluation of Multicore Fiber

— Multi Trace Analysis

Up to four traces can be overlaid on the display for analysis and comparison.

This is useful for evaluating connection point locations and loss after installing multicore fiber.

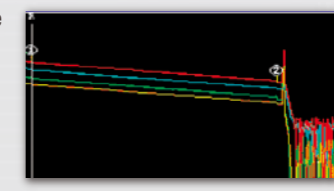

For Accurate Splice Loss Measurement by Bi-directional Testing

— 2 Way Trace Analysis

Merges the two traces measured from both directions and finds the correct splice loss.

Connection loss in lines where optical fibers of differing backscatter coefficients are connected can differ depending on the direction. In such cases, you can accurately determine the loss by measuring in both directions and taking an average.

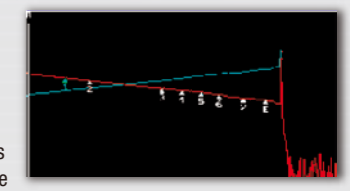

For Evaluation of Aged Deterioration

— Differential Trace Analysis

Displays the difference between two specified traces.

Makes it simple to check aged deterioration of fibers or connection points, or fluctuation in loss between fibers, and other phenomena.

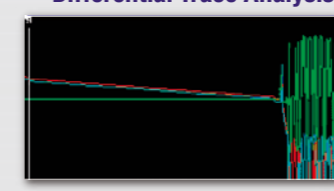

For Evaluation of Total Return Loss

— Section Analysis

Finds the total return loss in specific portions of the fiber.

This type of evaluation is often requested because the multiple reflections from optical fiber networks can affect signal light from transmitters (cable TV etc.).

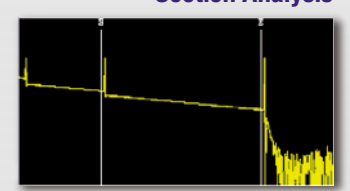

Visible Light Source*

Visual fault location and Fiber identification

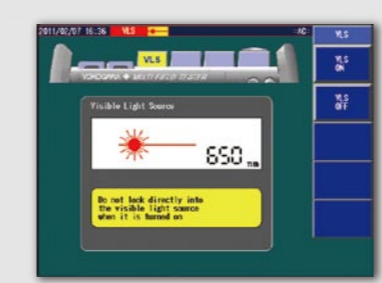

Visible light source screen

The visible light source enables to identify a single core out of multicore fiber and find a break point in a launch area visually. This feature works even when OTDR is in use, so that you can search for a next fiber to test, while OTDR is measuring one fiber.

* : /VLS option is required to use this function.

NEW Multi Fiber Measurement Function



The Multi fiber measurement function automatically performs measurements and data-filing according to a pre-established file name table. At worksite, you can execute it by simply selecting a fiber number in the table. The saved waveform can be easily shown in the preview

window by selecting the core number in the table. The OTDR Project File Editor included in AQ7932 Emulation Software greatly saves time to create file name table.

NEW Macro Bending Function (not available for the AQ1200B, AQ1200C)

If there is a bend in the optical fiber, the long wavelength loss is higher at the location of the bend. This function uses this characteristic to locate macro bends by measuring the same line at multiple wavelengths.



Remote Control Software

Remote Control using the same GUI

The AQ1200 can be remotely controlled from a personal computer (PC) through Ethernet* or USB interface. The remote control software displays a front panel image of AQ1200 on PC, so you can control the AQ1200 with mouse in the same manner as operating the actual instrument.

* : /LAN option is required to use this function.

Video Fiber Inspection Probe



Fiber Inspection Probe screen

Fiber end inspection

With a video fiber inspection probe connected to USB interface, the AQ1200 can show an image of the fiber end on the screen to visually inspect scratches and dirtiness. The video image can be saved in the internal memory or external USB storage media.

* : Recommended probe: CI 1100 B YOK (Lightel)

IP Test*

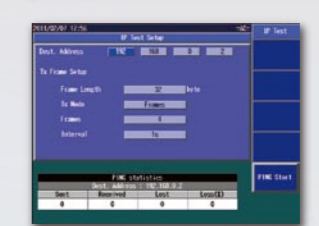

PING Test screen

IPv4 PING

For testing network connections by sending PING through the optional LAN interface, no need to bring a PC. Variable frame length and transmission intervals

* : /LAN option is required to use this function.

Data Analysis and Report Creation Tool

• AQ7932 OTDR Emulation Software (Sold Separately)

The AQ7932 is an application software that performs analysis of trace data measured by the AQ1200 MFT-OTDR and creates reports on a PC. The report creation wizard function makes this task simple. AQ1200 MFT-OTDR data can be easily loaded onto a PC using USB memory or storage function.
(The AQ1200 MFT-OTDR is supported from software version 4.1. Please make sure of the version information before use.)

■ Trace Analysis

You can edit event search conditions, approximate curve line secngs, and other analysis conditions, and repeat the analysis. Operation is also easy. Simply click the function icon.

■ Variety of Analysis Functions

Display up to eight traces on screen, and perform a variety of analyses including multi trace analysis and differential trace analysis for comparing recent waveforms with old ones, and use the 2 way trace analysis function for analyzing average values of data measured from both ends of optical fiber.

■ Creating Reports

You can compile traces and measured values of trace files and creates a report. Reports can be created easily by just following the step-by-step instructions in the report wizard and saved in Excel or CSV format.

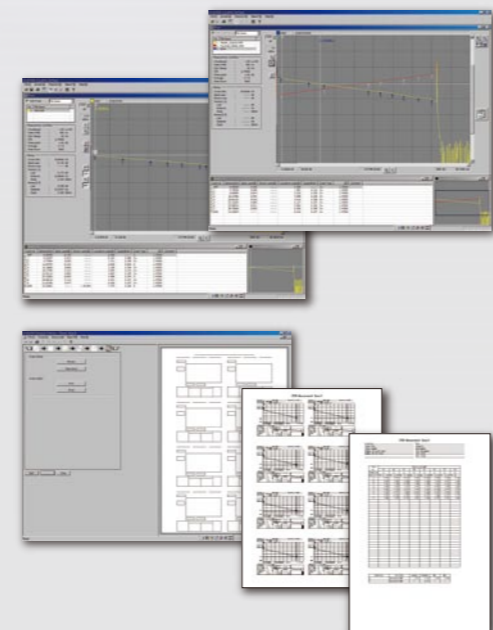

Microsoft Windows 2000, Windows XP, Windows Vista and Windows 7 are registered trademarks or trademarks of Microsoft Corporation in the United States and other countries. The TM and ® symbols are not used to indicate registered trademarks and trademarks in this document. (*) Microsoft Windows Vista is to be supported in Ver3.03 and later.

• Functionality

Data format: .SOR (Bellcore), .SOR (Telcordia [AQ1200/AQ7275/AQ7270/AQ7260]), TRD(AQ7260), .TRB(AQ7250), .BMP(BMP), .CSV (Data CSV), .CSV (Event List CSV)
Report output: CSV file, XLS file, and print out

• PC requirements (Software and Hardware)

- Software
OS: Microsoft Windows 2000, Microsoft Windows XP, Microsoft Windows Vista*, Windows 7
Excel: Microsoft Excel 2000 or later (when the XLS file output function is used)
- Hardware
Clock speed: Environment in which the OS operates smoothly.
HD capacity: 20 MB or more space required at the time of installation
Memory capacity: 128 MB or more (256 MB or more recommended)
Display: Resolution of 1024 × 768 pixels or better
Disc drive: CD-ROM drive

Comon Specifications

Horizontal Axis Parameters

Sampling resolution	5 cm, 10 cm, 20 cm, 50 cm, 1 m, 2 m, 4 m, 8 m, 16 m, 32 m
Readout resolution	1 cm (Min.)
Number of sampled data	Up to 128,000 points (Firmware Rev2.01 or later)
Group refractive index	1.30000 to 1.79999 (in 0.00001 steps)
Unit of distance	km, kf or miles
Distance measurement accuracy	±1 m + Measurement distance × 2 × 10 ⁻⁵ ± sampling resolution Excluding IOR uncertainty

Vertical Axis Parameters

Vertical axis scale	0.2 dB/div, 0.5 dB/div, 1 dB/div, 2 dB/div, 5 dB/div, 7.5 dB/div
Readout resolution	0.001 dB (Min.)
Loss measurement accuracy	±0.05 dB/dB (When the measuring loss is 1 dB or less, the accuracy is within ±0.05 dB.)

OTDR Measurement Function

Distance measurement	Displays up to eight digits of the relative one way direction between two arbitrary points on the trace.
Loss measurement	Displays one way loss in steps of 0.001 dB to a maximum of 5 digits. Displays the one way loss, loss per unit length, and splice loss between any arbitrary points on the trace.
Return loss measurement	Measures return loss and total return loss of a fiber cable or between two arbitrary points on the trace.

OTDR Analysis Functions

Analysis functions Section analysis

Internal Memory

Memory capacity 1000 waveforms or more
Can store measured waveforms and measurement conditions

Display

Display 5.7 inch color TFT LCD
Total number of displayed pixels* 640 (horizontal) × 480 (vertical) pixels

*: The LCD may contain some pixels that are always ON or OFF (0.002% or fewer of all displayed pixels including RGB), but this is not indicative of a general malfunction.

External Interface

USB USB1.1 Type A and Type B, one each
Type A: For external memory, external printer, and fiber inspection probe
Type B (mini): For connecting to an external PC for remote control or access to the OTDR's internal memory.

File Formats

File formats Read: SOR, SET (AQ7270/AQ7275/AQ1200)
Write: SOR (Telcordia), SET, CSV, BMP, JPG, PNG

Specifications per Model

Model name	AQ1200A	AQ1200B ^{*1}	AQ1200C ^{*1}	AQ1200E ^{*1}	AQ1205A	AQ1205E ^{*1}	AQ1205F ^{*1}
Measured wavelength (nm)	1310±20(typ) ^{*2} / 1550±20(typ) ^{*2}	1625±10	1650±5 ^{*3} , 1650±10 ^{*4}	1310±20(typ) ^{*2} / 1550±20(typ) ^{*2} , 1625±10	1310±20(typ) ^{*2} / 1550±20(typ) ^{*2}	1310±20(typ) ^{*2} / 1550±20(typ) ^{*2} , 1625±20(typ)	1310±20(typ) ^{*2} / 1550±20(typ) ^{*2} , 1650±5 ^{*3} , 1650±10 ^{*4}
Optical Port	PORT2			PORT2, 3	PORT2	PORT2, 3	
Measured fiber	SM (ITU-T G.652)						
Distance range(km)	0.5, 1, 2, 5, 10, 20, 50, 100, 200, 300, 400, 512 ^{*11}			0.5, 1, 2, 5, 10, 20, 50, 100, 200, 300, 400, 512			
Pulse width(ns)	3, 10, 20, 50, 100, 200, 500, 1000, 2000, 5000, 10000, 20000 ^{*11}			3, 10, 20, 50, 100, 200, 500, 1000, 2000, 5000, 10000, 20000			
Event Dead zone (typ.) ^{*7}	0.75m ^{*8}						
Attenuation Dead zone (typ.) ^{*9}	4m/5m	7m		4m/5m, 7m	4m/5m	4m/5m, 7m	
Dynamic range(dB) (typ.)	34/32 ^{*5}	33 ^{*5}	34 ^{*5}	38/36,36 ^{*5}	42/40 ^{*6}	42/40,38 ^{*6}	42/40,37 ^{*6}
Loss measurement accuracy	±0.05dB or ±0.05dB/dB						
Optical connector	Universal Adapter SC, FC						
Output power control ^{*10}	---			Normal / Low	---		Normal / Low
Laser safety standard	Class 1M						

^{*1}: Pulse light output poert at 1625 nm and 1650 nm, +15 dB or less, built-in 1310 & 1550 nm cut filter.
^{*2}: 25 nm is guaranteed
^{*3}: At a point -20 dB from the pulse light output peakvalue (measured after 30 minutes or more form power-on at an ambient temperature of 23°C)
^{*4}: At a point -60 dB from the pulse light output peakvalue (measured after 30 minutes or more form power-on at an ambient temperature of 23°C)
^{*5}: SNR=1, Pulse width: 10 µs, measurement time: 3 minutes, When angled -PC connectors are used, each dynamic range decreases by 0.5 dB, Guaranty value [dB]: 32/30 (AQ1200A), 30 (AQ1200B), 30 (AQ1200C), 32/30, 30 (AQ1200E)
^{*6}: SNR=1, Pulse width: 20 µs, measurement time: 3 minutes, When angled -PC connectors are used, each dynamic range decreases by 0.5 dB, Guaranty value [dB]: 40/38 (AQ1205A), 40/38, 36 (AQ1205E), 40/38, 30 (AQ1205F)
^{*7}: Pulse width 3 ns, return loss: 55 dB or more
^{*8}: 0.8 m is guaranteed
^{*9}: Pulse width 10 ns, Return loss 55 dB or more, at a point where the backscatter level is within ±0.5 dB of the normal value.
^{*10}: At 1625 nm and 1650 nm
^{*11}: FirmWare Rev2.01 or later

Note : Specifications are at 23°C ±2°C unless otherwise noted.

Specifications per Option

• Light source & Optical powermeter option

Optical Power meter	Power meter type	Standard (/SLT)	High Power (/HLT)	PON (/PPM)
	Wavelength setting	850/1300/1310/1490/1550/1625/1650 nm or 800 to 1700 nm (1 nm steps) or CWDM wavelength (1270 to 1610 nm, 20 nm step)		1310/1490/1550 nm
Power range	CW	+10 to -70 dBm	+27 to -50 dBm ^{*3}	+10 to -70 dBm ^{*1} , +27 to -50 dBm ^{*2}
	CHOP	+7 to -60 dBm	+24 to -50 dBm ^{*3}	---
Noise level	0.5 nW (-63 dBm, 1310 nm)		50 nW (-43 dBm, 1310 nm)	0.5 nW (-63 dBm, 1310 nm), 50 nW (-43 dBm, 1550 nm)
Uncertainty under standard conditions ^{*4}	±5%		±0.5 dB	±0.5 dB
Readout resolution	0.01			
Level unit	Absolute: dBm, mW, µW, nW Relative: dB			
Modulation mode	CW, CHOP (270 Hz/1 kHz/2 kHz)			
Average function	1, 10, 50, and 100 times			
Light source	Wavelength (nm)	1310/1550 ±25 nm (AQ1200A/E, AQ1205A/E/F), 1625 ±10 nm (AQ1200B/E), 1625 ±25 nm (AQ1205E), 1650 ±5 nm ^{*5} , 1650 ±10 nm ^{*6} (AQ1200C, AQ1205F)		
	Optical output level (dBm)	-3±1		
	Level stability (dB) ^{*7}	±0.05 (AQ1200A), ±0.15 (AQ1200B, AQ1200C)		
	Modulation mode	CW, 270 Hz, 1 kHz, 2 kHz		
Applicable fiber	SM (ITU-T G.652)			
Memory and logging function	Measurement data storage: 10 to 1000 data, Logging interval: 0.5, 1, 2, 5, or 10 sec.			
Auto loss test function	Loss measurement with light source and optical powermeter interlock		---	

^{*1}: at 1310/1490 nm ^{*2}: at 1550 nm ^{*3}: 1300 to 1600 nm
^{*4}: Power level: 100 µW(-10dBm); CW, Wavelength: 1310 ±20 nm (1550 nm ±10 nm for 1550 nm setting of /PPM), Spectral width: 10 nm or less (1310 nm), ambient temperature: 23 ±2°C, Optical fiber: SM (ITU-T G.652), Optical connector: FC/PC, Wavelength setting error: 0.5 nm or less, excluding aging (add 1% one year after calibration)
^{*5}: At a point -20 dB from the pulse light output peak value (measured after 30 minutes or more from power-on, at ambient temperature of 23°C)
^{*6}: At a point -60 dB from the pulse light output peak value (measured after 30 minutes or more from power-on, at ambient temperature of 23°C)
^{*7}: Constant temperature within 23°C ±2°C; CW (15 min.)

• Visible light source (VLS) option

Optical connector	2.5 mm ferrule type
Center wavelength	650 nm ±20 nm
Optical output level	-3 dBm or more (peak)
Modulation mode	CHOP Approx. 2 Hz
Laser class	3R



• Ethernet interface option

Interface	10BASE T / 100BASE TX
Functions	PING test, PC remote control

General Specifications

Item		Specification
Environmental conditions	Storage temperature	-20 to 60°C
	Operating temperature	0 to 45°C (0 to 40°C when AC adapter is being used); (0 to 35°C when battery is being charged)
	Humidity	20 to 85% RH (no condensation)
Power requirements		100 to 240 VAC, 50/60 Hz
Battery pack		Run time: 6 hours ^{*1} , Recharge time: 5 hours ^{*2}
Dimensions		217.5 (W) × 157 (H) × 74 (D) mm, excluding projections
Mass		Approx. 1 kg, including battery pack
Compliant standards	Laser safety	Class 1 M (IEC 60825-1:2007) ^{*3} , 21CFR1040.10 ^{*4}
	Safety	EN61010-1
	Emissions	EN61326-1 class A, EN55011 class A, group 1
	Immunity	EN61326-1 Table 2 (for industrial locations)

*1 : In case measurement is performed for 30 seconds every 3 minutes, with no options installed, in power save mode (LCD brightness: Power save, Screen saving: ON).
 *2 : at temperature of 23°C, power OFF



IEC 60825-1

*4 Complies with 21 CFR 1041.10 and 1041.11 except for deviations pursuant to Laser Notice No.55 (dated June 23, 2009) Toshiba Safety & Electronic Instruments Co., Ltd. 104-6584, Japan 21CFR1040.10

Model and suffix code

Models	Suffix code	Descriptions
AQ1200A		1310/1550 nm
AQ1200B		1625 nm
AQ1200C		1650 nm
AQ1200E		1310/1550, 1625 nm
AQ1205A		1310/1550 nm, High Dynamic Range
AQ1205E		1310/1550, 1625 nm High Dynamic Range
AQ1205F		1310/1550 nm High Dynamic Range, 1650 nm
Language	-HE	English
	-HC	Chinese/English
	-HK	Korean/English
	-HR	Russian/English
Power cord	-D	UL/ CSA standard
	-F	VDE standard
	-R	AS standard
	-Q	BS, Singapore standard
	-H	GB standard, Complied with CCC
	-P	EK standard (S. Korea)
	-T	BSMI standard
-N	Brazil standard	
Optical connector	-USC	SC type
	-UFC	FC type
	-ASC	SC/Angled-PC type
Light source & optical power meter	/SLT	Stabilized light source & Standard optical power meter
	/HLT	Stabilized light Source & High power optical power meter
	/PPM	Light source & PON Power meter
Visible light source	/VLS	Optical connector: 2.5φ ferrule
PON measurement*	/PN	PON measurement mode
Ethernet	/LAN	10BASE T/100BASE TX (PING test, Remote control)
Shoulder belt	/SB	Shoulder belt

* : Only for AQ1200A, AQ1200B/C/E and AQ1205A/E/F come equipped this function. The mode is optimized for PON measurement.

Accessories (optional)

Model	Suffix code	Descriptions
SU2006A		Soft carrying case
735480 (For optical powermeters)	-SCC	Connector adapter (SC)
	-FCC	Connector adapter (FC)
735481 (For optical powermeters)	-LMC	Ferrule adapter (φ1.25)*
	-SFC	Ferrule adapter (φ2.5)*
SU2005A (For OTDR, LS and PON Power meter)	-SCC	Universal adapter (SC)
	-FCC	Universal adapter (FC)
739871	-D	UL/CSA standard
	-F	VDE standard
	-R	AS standard
	-Q	BS, Singapore standard
	-H	GB standard, Complied with CCC
	-P	EK standard (S. Korea)
	-T	BSMI standard
-N	Brazil standard	
739882		Battery pack (Spare)
B8070CY		Shoulder belt

* : The ferrule adapter has no mechanism to lock the connected fiber. Please be cautious of the connection, especially when emitting high power light.

Dimensions

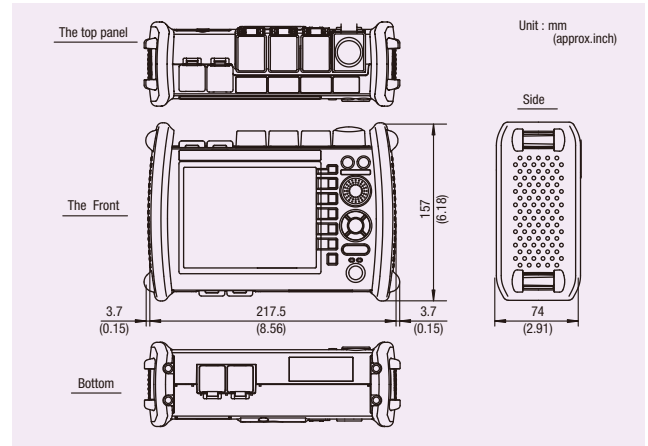

Related Products

OTDR

AQ7275

Superior OTDR for Core, Metro, and Access networks



- Wide Range of Modules Available (9 models)
- World-class Short Dead Zone (0.8 m)
- High Dynamic Range (45 dB)
- Multi-core fiber measurement function to increase work efficiency

OLTS

AQ1100 MFT-OLTS

Light Source + Optical Power Meter



Light Sources (3 models)

SM1310/1550 nm SM1310/1550/1625 nm MM850/1300 nm and SM1310/1550 nm

Optical Power Meter Selections

Standard : +10 to -70 dBm
 High power : +27 to -50 dBm
 PON : 1490/1550 nm
 Parallel measurement (split)

Application Software

Model	Suffix code	Descriptions
735070	-EN	AQ7932 OTDR Emulation Software (Ver4.1 or later) Display English

Yokogawa's Approach to Preserving the Global Environment

- Yokogawa's electrical products are developed and produced in facilities that have received ISO14001 approval.
- In order to protect the global environment, Yokogawa's electrical products are designed in accordance with Yokogawa's Environmentally Friendly Product Design Guidelines and Product Design Assessment Criteria.

NOTICE

- Before operating the product, read the user's manual thoroughly for proper and safe operation.
- If this product is for use with a system requiring safeguards that directly involve personnel safety, please contact the Yokogawa sales offices.



YOKOGAWA METERS & INSTRUMENTS CORPORATION

Global Sales Dept. /Phone: +81-42-534-1413 Facsimile: +81-42-534-1426

E-mail: tm@cs.jp.yokogawa.com

YOKOGAWA CORPORATION OF AMERICA

YOKOGAWA EUROPE B.V.

YOKOGAWA ENGINEERING ASIA PTE. LTD.

Phone: (1)-770-253-7000, Fax: (1)-770-254-0928

Phone: (31)-88-4641000, Fax: (31)-88-4641111

Phone: (65)-62419933, Fax: (65)-62412606

Subject to change without notice.

[Ed : 01/b]

Copyright © 2011, Yokogawa Meters & Instruments Corporation.

Printed in Japan, 206(KP)