

AETECHRON®



7224 & 7226

Operator's Manual

Single-Channel Industrial Amplifiers for Demanding, High-Power Systems

574.295.9495 | www.AETechron.com
2507 Warren Street, Elkhart, IN 46516

Limited One-Year Warranty

SUMMARY OF WARRANTY

AE TECHRON INC. of Elkhart, Indiana (Warrantor) warrants to you, the ORIGINAL COMMERCIAL PURCHASER ONLY of each NEW **AE TECHRON INC.** product, for a period of one (1) year from the date of purchase, by the original purchaser (warranty period) that the product is free of defects in materials or workmanship and will meet or exceed all advertised specifications for such a product. This warranty does not extend to any subsequent purchaser or user, and automatically terminates upon your sale or other disposition of our product.

ITEMS EXCLUDED FROM WARRANTY

We are not responsible for product failure caused by misuse, accident or neglect. This warranty does not extend to any product on which the serial number has been defaced, altered, or removed. It does not cover damage to loads or any other products or accessories resulting from AE TECHRON INC. product failure. It does not cover defects or damage caused by the use of unauthorized modifications, accessories, parts, or service.

WHAT WE WILL DO

We will remedy, at our sole discretion, any defect in materials or workmanship by repair, replacement, or refund. If a refund is elected, you must make the defective or malfunctioning component available to us free and clear of all liens or other encumbrances. The refund will be equal to the actual purchase price, not including interest, insurance, closing costs, and other finance charges less a reasonable depreciation on the product from the date of original purchase. Warranty work can only be performed at our authorized service centers or at our factory. Expenses in remedying the defect will be borne by **AE TECHRON INC.**, including one-way surface freight shipping costs within the United States. (Purchaser must bear the expense of shipping the product between any foreign country and the port of entry in the United States and all taxes, duties, and other customs fees for such foreign shipments.)

HOW TO OBTAIN WARRANTY SERVICE

When you notify us of your need for warranty service,

we will give you an authorization to return the product for service. All components must be shipped in a factory pack or equivalent which, if needed, may be obtained from us for a nominal charge. We will take corrective actions within a reasonable time of the date of receipt of the defective product. If the repairs made by us are not satisfactory, notify us immediately.

DISCLAIMER OF CONSEQUENTIAL AND INCIDENTAL DAMAGES

You are not entitled to recover from us any consequential or incidental damages resulting from any defect in our product. This includes any damage to another product or products resulting from such a defect.

WARRANTY ALTERATIONS

No person has the authority to enlarge, amend, or modify this warranty. The warranty is not extended by the length of time for which you are deprived of the use of this product. Repairs and replacement parts provided under the terms of this warranty shall carry only the unexpired portion of this warranty.

DESIGN CHANGES

We reserve the right to change the design of any product from time to time without notice and with no obligation to make corresponding changes in products previously manufactured.

LEGAL REMEDIES OF PURCHASER

There is no warranty that extends beyond the terms hereof. This written warranty is given in lieu of any oral or implied warranties not contained herein. We disclaim all implied warranties, including, without limitation, any warranties of merchantability or fitness for a particular purpose. No action to enforce this Warranty shall be commenced later than ninety (90) days after expiration of the warranty period.

AE Techron, Inc.

Customer Service Department
2507 Warren Street
Elkhart, IN 46516
U.S.A.
574.295.9495
www.aetechron.com

DECLARATION OF CONFORMITY

Technical Construction File Route

Issued By: AE Techron, Inc.
2507 Warren Street
Elkhart, IN 46516

For Compliance Questions Only: Larry Shank
574-295-9495
lshank@aetechron.com

This Declaration of Conformity is issued under the sole responsibility of AE Techron, Inc., and belongs to the following product:

Equipment Type: Industrial Power Amplifiers

Model Name: 7224

EMC Standards:

- EN 61326-1: 2013 – Electrical Equipment for Measurement, Control and Laboratory use
 - EMC Requirements
- EN 55011: 2009 + A1: 2010 – Industrial, Scientific and Medical (ISM) radio-frequency equipment
 - Radio disturbance characteristics
 - Limits and methods of measurement
- EN 61000-4-2: 2009 – Electromagnetic compatibility (EMC) Part 4: Testing and measurement techniques:
Electrostatic discharge immunity test
- EN 61000-4-3: 2006 + A2: 2010 – Electromagnetic compatibility (EMC) Part 4: Testing and measurement techniques:
Radiated radio-frequency electromagnetic field immunity test
- EN 61000-4-4: 2004 + A1: 2010 – Electromagnetic compatibility (EMC) Part 4: Testing and measurement techniques:
Electrical fast transient/burst immunity test
- EN 61000-4-5: 2006 – Electromagnetic compatibility (EMC) Part 4: Testing and measurement techniques:
Surge immunity test
- EN 61000-4-6: 2009 – Electromagnetic compatibility (EMC) Part 4: Testing and measurement techniques:
Immunity to conducted disturbances induced by radio frequency field
- EN 61000-4-8: 2010 – Electromagnetic compatibility (EMC) Part 4: Testing and measurement techniques:
Power frequency magnetic field immunity test

Safety Standard:

- BSEN61010-1:2010 (inc Corr. May 2011) – Safety requirements for electrical equipment for measurement, control, and laboratory use

I certify that the product identified above conforms to the requirements of the EMC Council Directive 2004/108/EC (until 19th April, 2016) and Directive 2014/30/EU (from 20th April, 2016), and the Low Voltage Directive 2006/95/EC (until 19th April, 2016) and Directive 2014/35/EU (from 20th April, 2016).

Signed:

Larry Shank
President



Place of Issue: Elkhart, IN, USA
Date of Issue: March 18, 2016

CE Affixing Date: March 4, 2011

DECLARATION OF CONFORMITY

Technical Construction File Route

Issued By: AE Techron, Inc.
2507 Warren Street
Elkhart, IN 46516

For Compliance Questions Only: Larry Shank
574-295-9495
lshank@aetechron.com

This Declaration of Conformity is issued under the sole responsibility of AE Techron, Inc., and belongs to the following product:

Equipment Type: Industrial Power Amplifiers

Model Name: 7226

EMC Standards:

- EN 61326-1: 2013** – Electrical Equipment for Measurement, Control and Laboratory use
— EMC Requirements
- EN 55011: 2009 + A1: 2010** – Industrial, Scientific and Medical (ISM) radio-frequency equipment
— Radio disturbance characteristics
— Limits and methods of measurement
- EN 61000-4-2: 2009** – Electromagnetic compatibility (EMC) Part 4: Testing and measurement techniques:
Electrostatic discharge immunity test
- EN 61000-4-3: 2006 + A2: 2010** – Electromagnetic compatibility (EMC) Part 4: Testing and measurement techniques:
Radiated radio-frequency electromagnetic field immunity test
- EN 61000-4-4: 2004 + A1: 2010** – Electromagnetic compatibility (EMC) Part 4: Testing and measurement techniques:
Electrical fast transient/burst immunity test
- EN 61000-4-5: 2006** – Electromagnetic compatibility (EMC) Part 4: Testing and measurement techniques:
Surge immunity test
- EN 61000-4-6: 2009** – Electromagnetic compatibility (EMC) Part 4: Testing and measurement techniques:
Immunity to conducted disturbances induced by radio frequency field
- EN 61000-4-8: 2010** – Electromagnetic compatibility (EMC) Part 4: Testing and measurement techniques:
Power frequency magnetic field immunity test

Safety Standard:

BSEN61010-1:2010 (inc Corr. May 2011) – Safety requirements for electrical equipment for measurement, control, and laboratory use

I certify that the product identified above conforms to the requirements of the EMC Council Directive 2014/30/EU, and the Low Voltage Directive 2014/35/EU.

Signed:

Larry Shank
President



Place of Issue: Elkhart, IN, USA
Date of Issue: August 16, 2017

CE Affixing Date: August 7, 2017

Contents

1	Introduction	7
1.1	Features	7
2	Amplifier Unpacking and Installation	8
2.1	Safety First	8
2.2	Unpacking	8
2.3	Installation	8
3	Connections and Startup	9
3.1	Other Operation Modes and Configurations	9
3.2	Connecting the Load	9
3.3	Connecting the Input Signal	10
3.4	Connecting the AC Supply	11
3.5	Start-up Procedure	12
4	Amplifier Operation	13
4.1	Front-Panel Controls	13
4.2	Back-Panel Controls and Connectors	16
5	Advanced Configuration	17
5.1	Configuration Access Panel	17
5.2	Configuration Settings Located on the Main Board	17
5.3	Configuration Settings Located on the Power Supply Board	20
6	Applications	23
6.1	Remote Status and Control using the SIM Interlock I/O Connector	23
6.2	Controlled Current Operation	27
6.3	Multi-amplifier Systems	31
7	Amplifier Signal Flow	39
7.1	Input Signals	39
7.2	AC Mains Power	39
8	Maintenance	40
8.1	Clean Amplifier Filter and Grills	40
9	Troubleshooting	41
9.1	Introduction & Precautions	41
9.2	Visual Inspection	41
9.3	No Signal	42
9.4	No LEDs Illuminated or No Fans	42
9.5	OverVoltage LED Lit	42
9.6	Standby LED Remains Illuminated	42
9.7	Amplifier Overheats (Over Temp Fault Condition)	43
9.8	Fault LED is Illuminated	43
9.9	Factory Service	43
10	Specifications	45

List of Figures

Figure 1.1 – 7224 & 7226 Front Panels.....	7
Figure 3.1 – 7224/7226 Back Panel.....	9
Figure 3.2 – Closeup of the Output Terminal Resistor.....	10
Figure 3.3 – Connecting the Load.....	10
Figure 3.4 – Closeup of SIM card.....	10
Figure 3.5 – Wiring for Unbalanced or Balanced Input Connector.....	11
Figure 3.6 – Closeup of AC Mains Outlet.....	11
Figure 3.7 – Sample of Configurations Setting Label.....	11
Figure 4.1 – Power Switch.....	13
Figure 4.2 – Gain Control.....	13
Figure 4.3 – Push Buttons.....	14
Figure 4.4 – Indicators.....	14
Figure 4.5 – Main Status Indicators.....	14
Figure 4.6 – Fault Status Indicators.....	15
Figure 4.7 – Back Panel Controls and Connectors.....	16
Figure 5.1 – Access Panel Screw Locations.....	17
Figure 5.2 – Main Board Location Inside Access Panel.....	18
Figure 5.3 – Master/Slave Setting.....	18
Figure 5.4 – Gain Trim Control.....	18
Figure 5.5 – Controlled-Voltage/Controlled-Current Mode Setting.....	19
Figure 5.6 – Compensation Setting.....	19
Figure 5.7 – Run Mode/Stop Mode on Power-Up Setting.....	20
Figure 5.8 – Standby Mode on Over Load Setting.....	20
Figure 5.9 – Accessing the Power Supply Board.....	21
Figure 5.10 – Location of Amplifier High-Voltage Transformer Sockets.....	21
Figure 5.11 – J3 and J7 Plug Locations for High-Current Output.....	21
Figure 5.12 – J4 and J8 Plug Locations for High-Voltage Output.....	21
Figure 5.13 – Bi-Level Power Switch Location.....	21
Figure 6.1 – Remote Status and Control Pinouts.....	23
Figure 6.2 – Remote Run/Standby Monitor.....	23
Figure 6.3 – Remote Status and Reset Schematic.....	24
Figure 6.4 – Remote Enable/Standby.....	25
Figure 6.5 – Remote Current Monitoring.....	26
Figure 6.6 – Remote Current Monitoring, Alternate Method.....	26
Figure 6.7 – Input to Output Comparison, Controlled-Voltage Operation.....	27
Figure 6.8 – Input to Output Comparison, Controlled-Current Operation.....	27
Figure 6.9 – Factory-installed Default RC Network.....	28
Figure 6.10 – Custom Compensation Location.....	30
Figure 6.11 – Compensation Effects on Waveform.....	30
Figure 6.12 – Square Wave Showing a Decrease in R is Required.....	30
Figure 6.13 – Square Wave Showing an Increase in R is Required.....	30
Figure 6.14 – Square Wave Showing a Decrease in C is Required.....	30
Figure 6.15 – Main Status Indicators for Multi-Amplifier Systems.....	33
Figure 6.16 – Fault Status Indicators for Multi-Amplifier Systems.....	34
Figure 7.1 – Board-Level Functional Block Diagram.....	39
Figure 9.1 – +Vcc and –Vcc Point Locations.....	41
Figure 9.2 – Fuse F1 Location.....	42
Figure 9.3 – Interlock I/O Connector.....	42
Figure 10.1 – 7224 Voltage Potential vs. Frequency.....	47
Figure 10.2 – 7226 Voltage Potential vs. Frequency.....	47
Figure 10.3 – 7224 & 7226 Frequency Response.....	47
Figure 10.4 – 7224 Noise vs. Frequency.....	47
Figure 10.5 – 7224 Continuous Power vs. Frequency.....	47
Figure 10.6 – 7224 Thermal Performance.....	47
Figure 10.7 – 7224 DC Current Over Time at 13.5 VDC.....	48
Figure 10.8 – 7224 DC Current Over Time Comparison with 4-ohm Load.....	48
Figure 10.9 – 7224 DO 160 Section 18.2 AC Power Processing.....	48



Figure 1.1 – 7224 & 7226 Front Panels

1 Introduction

Congratulations on your purchase of the 7224 or 7226 AE Techron power amplifier—one of the most precise power amplifiers ever produced for industrial applications and testing. The 7224 and 7226 amplifiers are built and tested to the most stringent quality standards for long life and outstanding performance. The AE Techron brand is known throughout the world for its robust precision amplifiers as well as its product service and support.

1.1 Features

The 7224/7226 is a single-channel linear amplifier designed for use in demanding applications requiring low noise, low distortion, and accurate power amplification from DC to 300 kHz. They feature:

- Small-signal bandwidth of DC to 300 kHz.
- Continuous output of over 900 watts RMS at 4 ohms.
- 40 mSec pulses of up to 52 amperes peak into a 0.5 ohm load.
- System output of over 3,600 watts or over 200 amperes maximum is possible with multiple, interconnected amplifiers.
- Efficient design and light weight chassis materials allow amplifier to occupy only 2U height, and weigh only 41 lbs.
- Robust, linear power supply results in extremely low noise; bi-level switch design limits heat dissipation to output devices.
- Protection circuitry protects the amplifier from input overloads, improper output connection (including shorted and improper loads), over-temperature, over-current, and supply voltages that are too high or low.
- Shipped ready to operate from 120-volt ($\pm 10\%$) single-phase AC mains; 220/240-volt model available on request.

2 Amplifier Unpacking and Installation

The 7224/7226 amplifiers are precision instruments that can be dangerous if not handled properly. Lethal voltages are present in both the AC input supply and the output of these amplifiers. For this reason, safety should be your primary concern when you setup and operate this amplifier.

2.1 Safety First

Throughout this manual special emphasis is placed on good safety practices. The following graphics are used to highlight certain topics that require extra precaution.

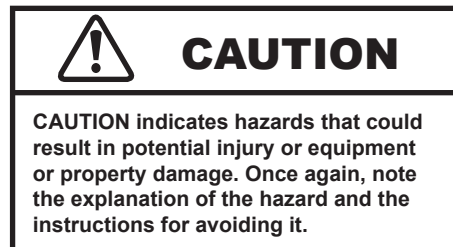
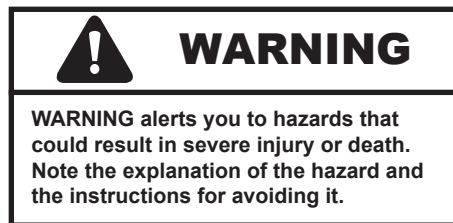
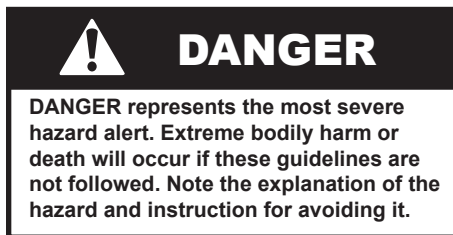

2.2 Unpacking

All amplifiers are tested and inspected for damage before leaving the factory. Carefully unpack and inspect the amplifier for damage. **Please note any damage for future reference and notify the shipping company immediately if damage is found.** Also, please save the shipping carton and materials as evidence of damage and/or for returning the amplifier for repair.

Along with any additional accessories purchased by the customer, all 7224/7226 amplifiers ship with the following:

- 7224 or 7226 Amplifier
- Toolkit (contains one #2 Phillips screwdriver and four rubber feet)
- Power Cord
- Operator's Manual and Quick Start sheet

2.3 Installation

The 7224/7226 amplifiers are packaged in a rugged powder-coated aluminum chassis. This chassis is 2U (rack units) tall, and has rack "ears" on each side of the front panel for mounting to a standard EIA (Electronic Industries Association) rack. Use standard rack mounting hardware to mount the amplifier. Use nylon washers if you wish to protect the powder-coat finish on the front of the amplifier.

Optionally, the amplifier can be placed on a bench top; please keep in mind that the protective powder-coating can be scratched when placed on other equipment or on a bench top, especially when there is dirt present. To protect the finish, a set of rubber feet is included in the toolkit that can be installed on the bottom of the amplifier.

Allow ample space on the sides and especially the back of the amplifier for heated air to escape. The amplifier should be mounted in a rack that is adequately ventilated and not sealed. Likewise, the front of the amplifier should be unobstructed to allow cool air to enter the amplifier.

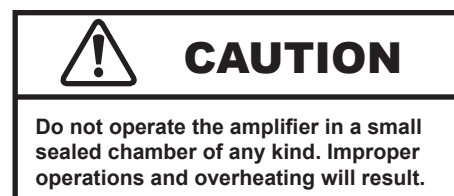





Figure 3.1 – 7224/7226 Back Panel

3 Connections and Startup

This section details the wiring and startup procedures for a single 7224 or 7226 amplifier operating in Controlled-Voltage mode (factory default). Before connecting the amplifier, make sure the AC power cord is unplugged.

	WARNING
ELECTRIC SHOCK HAZARD.	
Output potentials can be lethal. Make connections only with AC Power OFF and input signals removed.	

3.1 Other Operation Modes and Configurations

The 7224/7226 amplifier can be field-configured for operation in a number of ways. The amplifier can be operated in Controlled-Voltage or Controlled-Current mode. It also can be configured for operation as a part of a multi-amplifier system. These alternate configurations may require special output wiring and/or additional components.

3.1.1 Controlled-Current Operation of a Stand-Alone Amplifier

If your application requires Controlled Current operation, the amplifier first should be wired and tested in Controlled-Voltage mode to verify that the amplifier and input signal are operating correctly. Once proper operation is confirmed, refer to the “*Applications*” section of this manual for instructions on configuring and operating your amplifier in Controlled-Current mode.

3.1.2 Multi-Amp Operation

If your application requires multi-amp operation for increased voltage or current, each amplifier should

first be wired and tested individually in Controlled-Voltage mode to ensure proper operation.

To configure two or more amplifiers for **Series or Parallel operation in Controlled-Voltage mode**, refer to the *Multi-Amp Configuration Guide* (available for download from aetechron.com).

For **Series or Parallel operation in Controlled-Voltage mode**, refer to the “*Applications*” section of this manual.

For **Series operation in Controlled-Current mode**, you should select one amplifier to be operated as the “Master” amplifier of the system, and then refer to the “*Applications*” section of this manual for instructions on configuring this amplifier for operation in Controlled-Current mode. After the Master amplifier is configured and tested for Controlled-Current operation, refer to the *Multi-Amp Configuration Guide* (available for download from aetechron.com) for information on Series system configuration.

For **Parallel operation in Controlled-Current mode**, please contact **AE Techron Technical Support** for assistance.

3.2 Connecting the Load

3.2.1 Preparation and Cautions

Before connecting the amplifier, make sure the AC power is disconnected.

Always use the appropriate wire size and insulation for the maximum current and voltage expected at the output. Never connect the output of the

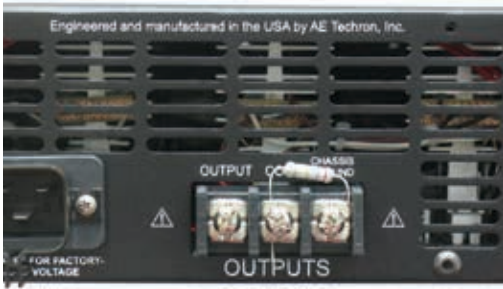

Figure 3.2 – Closeup of the Output Terminal Resistor

amplifier to any other model amplifier, power supply, signal source, or other inappropriate load; fire can result.

NOTE: The 7224/7226 amplifier comes with a factory-installed 2.7-ohm, 2W, 5%, metal-oxide resistor connecting the terminals marked “COM and “CHASSIS GROUND” (see **Figure 3.2**). This resistor should NOT be removed except when the amplifier is being used as a Slave amplifier in a Series multi-amp system. **WARNING: Removing this resistor can cause dangerous output and/or damage to the load.**

3.2.2 Connecting the Outputs

Connection to the output of the amplifier is to a 3-position terminal strip with #8 screws. Wires terminated with #8 ring terminals, tinned wires up to 10GA in size, or bus bars with 0.18 in. (4.6 mm) holes are recommended when connecting to the output terminals.

Connect the load across the terminals marked “OUTPUT” (positive) and “COM” (negative/ground). The third terminal, “CHASSIS GROUND”

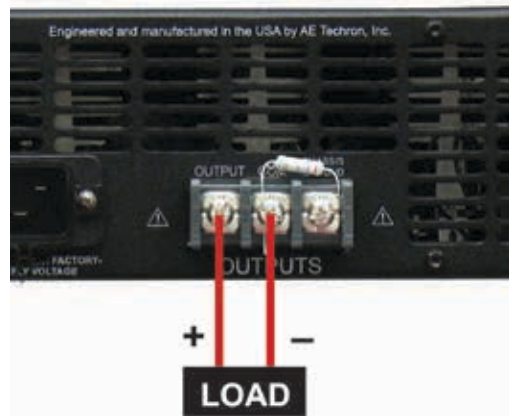

Figure 3.3 – Connecting the Load

can be connected to an external ground point such as the rack chassis. See **Figure 3.3**.

3.3 Connecting the Input Signal

The signal is connected to the amplifier through a “SIM (Specialized Input Module) Card” located on the amplifier back panel (see **Figure 3.4**). The SIM card offers the choice of BNC or “WECO” terminal block input connectors.

The Input Select switch, located on the SIM module between the input connectors, allows convenient selection of balanced or unbalanced input wiring and also can function as a ground-lift switch for the BNC input connector. The Input Select switch functions by connecting/ disconnecting the inverting (–) pin on each input connector to the amplifier ground through a 4.7-ohm resistor (see **Figure 3.5**). When the Input Select switch is in the LEFT position, the shield on the BNC connector



Figure 3.4 – Closeup of SIM card

and the inverting (–) pin on the terminal block connector are tied to the amplifier ground, allowing the connectors to be used for Unbalanced input wiring. When the Input Select switch is in the RIGHT position, the inverting (–) pin on the terminal block connector is floating, allowing the connector to be used for Balanced input wiring.

IMPORTANT: The Input Select switch can also function as a Ground Lift switch for the BNC Input connector. If circulating currents/ground loops/60-Hz Hum occur when using the BNC Input, move the Input Select switch to the right to lift the ground on the connector.

We recommend that you use cables that are high quality and shielded to minimize noise and to guard against possible feedback.

Note: See the “**Applications**” section for information on using the Interlock – I/O Connector located on the SIM card.

3.4 Connecting the AC Supply

The power cord connects to a standard 20 amp 3-pin IEC-type male connector on the back panel (see **Figure 3.6**). Make sure the Breaker/Switch on the front panel is switched to the OFF (O) position. Make sure the power cord is inserted and seated fully into the IEC connector by moving it slightly back and forth and up and down while pushing in. The power cord is relatively stiff and should be routed so that there is no excessive force pulling to the sides or up or down that would stress the pins or internal connections. Tighten the cord strain relief screw to lock the power cord in place.

Review the factory-set supply voltage and amplifier configuration detailed on the label placed on the side of the amplifier (see **Figure 3.7**). This configuration can be changed by the user. See the **Advanced Configuration** section for more information.

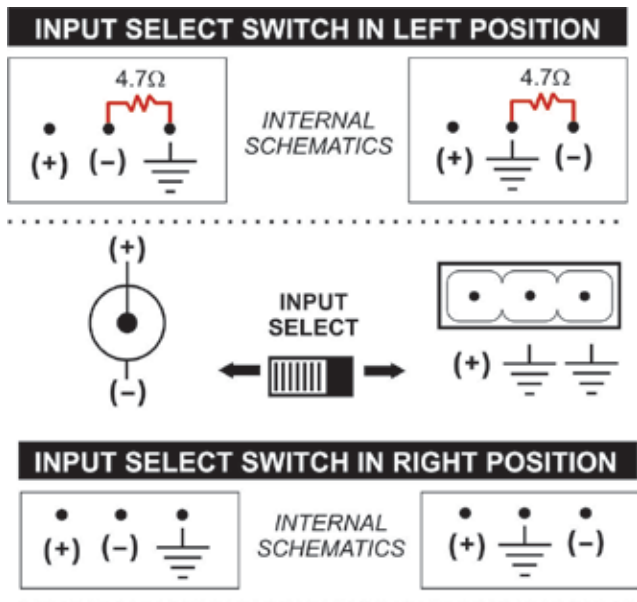

Figure 3.5 – Wiring for Unbalanced or Balanced Input Connector



Figure 3.6 – Closeup of AC Mains Outlet

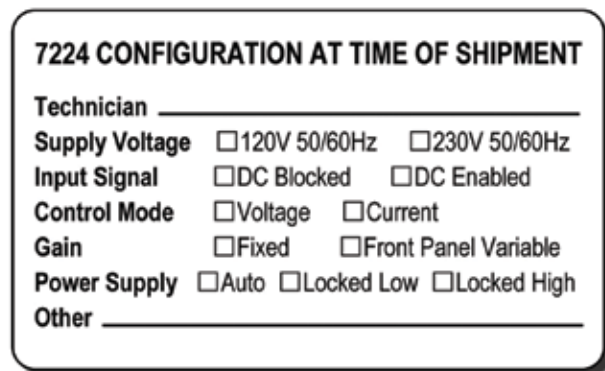

Figure 3.7 – Sample of Configurations Setting Label

3.5 Start-up Procedure

1. Turn down the level of your signal source.
2. Turn down the gain control of the amplifier.
3. Depress the POWER switch to turn the amplifier ON.
4. Wait for the yellow READY and green RUN LEDs to illuminate.
5. Adjust the level of your input signal source to achieve the desired output level.
6. Turn up the Gain control on the amplifier until the desired voltage or power level is achieved.
7. Adjust the input signal level to achieve the desired output level.

4 Amplifier Operation

4.1 Front-Panel Controls

This section provides an overview of Front-Panel controls and indicators found on the 7224/7226 amplifier.

4.1.1 Power Switch

The Power Switch controls the AC mains power to the amplifier. Switch to the ON position (I) to turn the amplifier on. Switch to the OFF position (O) to turn the amplifier off. See **Figure 4.1**.

The Power Switch also serves as a Breaker. When the Breaker is tripped, the Power Switch moves to a neutral position between ON and OFF. To reset the Breaker, turn the amplifier OFF (O) and then turn it back ON (I).

4.1.2 Gain Control

The Gain Control Knob increases/decreases the gain from 0 – 100% of the overall Gain (factory default Gain is 20). See **Figure 4.2**.



Figure 4.1 – Power Switch



Figure 4.2 – Gain Control

4.1.3 Push Buttons

The 7224/7226 provides three front-panel soft-touch push buttons that control two basic operating conditions: (1) **Run condition** (the high-voltage transformers are energized and the unit will amplify the input signal); and (2) **Standby condition** (the low-voltage transformer is energized but the high-voltage transformers are not and the unit will not amplify the input signal).

By default, the amplifier will automatically enter the Run condition on power-up. To change the factory-default setting and configure the amplifier to power-up in Standby/Stop mode, please see the **Advanced Configuration** section.

The amplifier will enter one of three Standby modes under the following conditions:

Remote Standby mode (Ready and Standby LEDs lit): The amplifier is functioning properly and all Fault Status modes are clear, but the unit has been placed in Standby by an external condition. If an amplifier is disabled using a Remote Standby application, the amplifier will be placed in Remote Standby mode. To return the amplifier to a Run condition, release the Standby condition using the remote switch. See the **Applications** section of this manual for more information on remote amplifier operation.

Standby/Fault mode (Standby and one or more Fault LEDs lit): The amplifier has been placed in Standby due to an Output, Overload, Over Temp or Over Voltage condition. See the section “Fault Status Indicators” to determine the fault condition being indicated and the action required to clear the fault condition.

Standby/Stop mode: The amplifier has been placed in Standby due to a Stop order: The Stop button on the amplifier front panel has been pushed or the amplifier has been configured to enter Stop mode on startup. See the **“Advanced Configuration”** section for information about configuring the amplifier for Startup in Stop mode.

Enable, Stop and Reset Buttons

The following details the results when each of the three Push Buttons are pressed on the amplifier front panel. See **Figure 4.3** for Push Button locations.

Enable – When the amplifier is in Standby/Stop mode, pressing the Enable button will release the amplifier from Standby and place the amplifier in Run mode. Pressing the Enable button will also release the amplifier from some Standby conditions.

Stop – Pressing the Stop button will place the amplifier in Standby/Stop mode (both Standby and Stop LEDs will be lit).

Reset – When the amplifier has been placed in Standby/Fault mode due to a fault condition, pressing the Reset button will return the amplifier to Run mode if the condition causing the fault condition has been cleared and the amplifier has been configured for startup in Run mode. If the ampli-

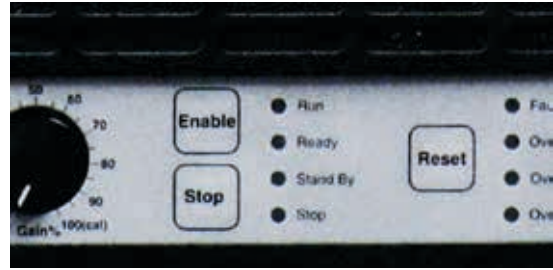

Figure 4.3 – Push Buttons

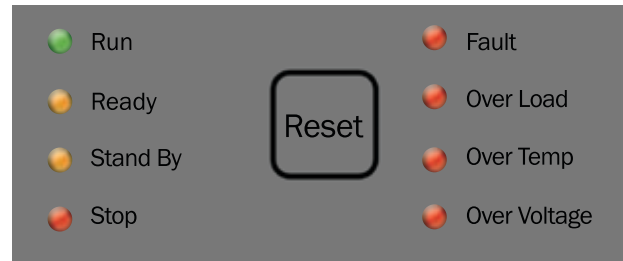

Figure 4.4 – Indicators

fier has been configured for startup in Stop mode, pressing the Reset button will place the amplifier in Standby/Stop mode. Press the Enable button to return the amplifier to Run mode.

Figure 4.5 – Main Status Indicators

● ● ● Indicator is lit ● Indicator is not lit ○ Indicator may be lit

Main Status Indicators	State of Operation	Action Needed to Return to Run Mode
<ul style="list-style-type: none"> ● Run ● Ready ● Standby ● Stop 	<p>Run mode: The amplifier's high-voltage transformers are energized and the unit will amplify the input signal. Run mode is initiated by: (1) the Enable push button, or (2) when the amplifier powers up in Run mode (factory default). See the "Advanced Configuration" section for more information.</p>	N/A
<ul style="list-style-type: none"> ● Run ● Ready ● Standby ● Stop 	<p>Remote Standby mode: Standby mode indicates that the amplifier is functioning properly and all Fault Status modes are clear, but it is being held in Standby by an external condition. As configured from the factory (Run mode on startup), the amplifier will enter Remote Standby mode briefly after powering up, and then will move automatically into Run mode. In Remote Standby mode, the amplifier's low-voltage transformer is energized but the high-voltage transformers are not.</p>	<p>If the amplifier remains in Remote Standby mode, it is being held in Standby by remote control through the SIM Interlock I/O connector. Open the Enable/Standby switch to clear this Remote Standby condition and return the amplifier to Run mode. See the "Applications" section of this manual for more information on remote amplifier operation.</p>
<ul style="list-style-type: none"> ● Run ● Ready ● Standby ● Stop 	<p>Standby/Stop mode: When the Stop button on the amplifier front panel is pressed, the amplifier will enter Standby/Stop mode. The amplifier may also enter Standby/Stop mode after powering up if the amplifier is configured to enter Stop mode on startup. In Standby/Stop mode, the amplifier's low-voltage transformer is energized but the high-voltage transformers are not.</p>	<p>To release the amplifier from Standby/Stop mode, press the Enable button.</p>

Front-Panel Indicators

4.1.4 Main Status Indicators

Four Main Status indicators are located on the amplifier's front-panel (see **Figure 4.4**). These LEDs monitor the internal conditions of the amplifier and indicate the current state of operation. The chart in

Figure 4.5 details the operational modes indicated by the Main Status indicators.

NOTE: See the “*Applications*” section for main status indicator interpretation when operating a multi-amp system.

Figure 4.6 – Fault Status Indicators

● ● ● Indicator is lit ● Indicator is not lit ○ Indicator may be lit

Main Status Indicators	Fault Status Indicators	State of Operation	Action Needed to Clear Fault Condition and Return to Run Mode
<ul style="list-style-type: none"> ● Run ● Ready ● Standby ● Stop 	<ul style="list-style-type: none"> ● Fault ● Over Load ● Over Temp ● Over Voltage 	<p>Output Fault status: This indicates that an Output Fault condition has occurred and the amplifier has been placed in Standby mode. The Fault indicator will light under two conditions: 1) High-frequency oscillation is causing high shoot-through current; or 2) An output transistor has shorted, causing the output fault condition.</p>	<p>This fault condition cannot be cleared using the front-panel Reset button. See the “<i>Troubleshooting</i>” section for more information on diagnosing and clearing this fault condition.</p>
<ul style="list-style-type: none"> ● Run ● Ready ○ Standby ● Stop 	<ul style="list-style-type: none"> ● Fault ● Over Load ● Over Temp ● Over Voltage 	<p>Over Load status: This indicates that the output of the amplifier could not follow the input signal due to voltage or current limits. Under normal operation with the factory-default settings, an Over Load condition will not place the amplifier in Standby mode. If the amplifier has been configured to be forced to Standby on Over Load, the amplifier will be placed in Standby mode when the Over Load indicator lights.</p>	<p>To remedy the Over Load fault during operation, turn down the level of the input signal until the Over Load indicator turns off. To clear an Over Load fault condition when the amplifier is forced to Standby, turn down the level of the input signal, then push the Reset button.</p>
<ul style="list-style-type: none"> ● Run ● Ready ● Standby ● Stop 	<ul style="list-style-type: none"> ● Fault ● Over Load ○ Over Temp ● Over Voltage 	<p>Over Temp status: The amplifier monitors the temperature inside the high-voltage transformers, low-voltage transformer and in the output stage heat sinks. The Over Temp indicator will light and the amplifier will be placed in Standby mode when the temperature sensors detect a condition that would damage the amplifier. If the Over Temp pulse is extremely short, as in the case of defective wiring or switches, the Over Temp LED may be lit too briefly to observe.</p>	<p>To reset after an Over Temp fault has occurred, make sure the fans are running, and then remove the input signal from the amplifier. Allow the fans to run for about 5 minutes, and then push and hold the Reset button to return the amplifier to Run mode (factory default) or Standby/ Stop mode (if the amplifier has been configured to start up in Standby mode). See the “<i>Troubleshooting</i>” section for information on correcting the cause of an Over Temp fault condition.</p>
<ul style="list-style-type: none"> ● Run ● Ready ● Standby ● Stop 	<ul style="list-style-type: none"> ● Fault ● Over Load ● Over Temp ● Over Voltage 	<p>Over Voltage status: This indicates that the AC mains voltage is more than +10% of nominal. The amplifier will be forced to Standby when an Over Voltage condition occurs. When the Over Voltage condition is cleared, the amplifier will automatically return to Run mode.</p>	<p>To clear an Over Voltage fault condition, the AC mains must be brought down to the nominal value. If the amplifier does not return to Run mode when the Over Voltage condition has cleared, the amplifier may require servicing. Please see the “<i>Troubleshooting</i>” section for more information.</p>

4.1.5 Fault Status Indicators

Four Fault Status indicators are located on the amplifier front panel (see **Figure 4.4**). These LEDs monitor the internal conditions of the amplifier and will illuminate when a fault condition occurs. Depending on the fault condition and the configuration of the unit, the amplifier may be placed in Standby mode when a fault condition occurs. Refer to the chart in **Figure 4.6** to determine the fault condition being indicated and the action required to clear the fault condition.

NOTE: See the “*Applications*” section for fault status indicator interpretation when operating a multi-amp system.

4.2 Back-Panel Controls and Connectors

This section provides an overview of Back-Panel controls and connectors found on the 7224/7226. Please refer to **Figure 4.7** for visual locations.

AC Supply – Standard 20 amp 3-pin IEC-type male connector.

Output Terminal Strip – Connect output lines

from the load to this 3-position terminal strip with #8 screws. It accepts up to #10 AWG wire.

BNC Input Connector – This input option provides a standard unbalanced input.

Input Selector Switch – When in the LEFT position, the unbalanced BNC input connector is enabled. When in the RIGHT position, both unbalanced BNC and balanced Phoenix® input connectors are enabled. The Input Select switch also functions as a Ground Lift switch for the Unbalanced BNC input connector. If circulating currents/ground loops/60-Hz Hum occur when using the unbalanced input, move the Input Select switch to the right to lift the ground on the connector.

Terminal Block Input Connector – This input option provides a balanced input. It can also be used as an unbalanced input.

Interlock Connector – This 25-pin, D-sub connector is used for interlocking and combining functions in a system of multiple amplifiers. It can also be used for remote control and monitoring applications (see the “*Applications*” section for more information).

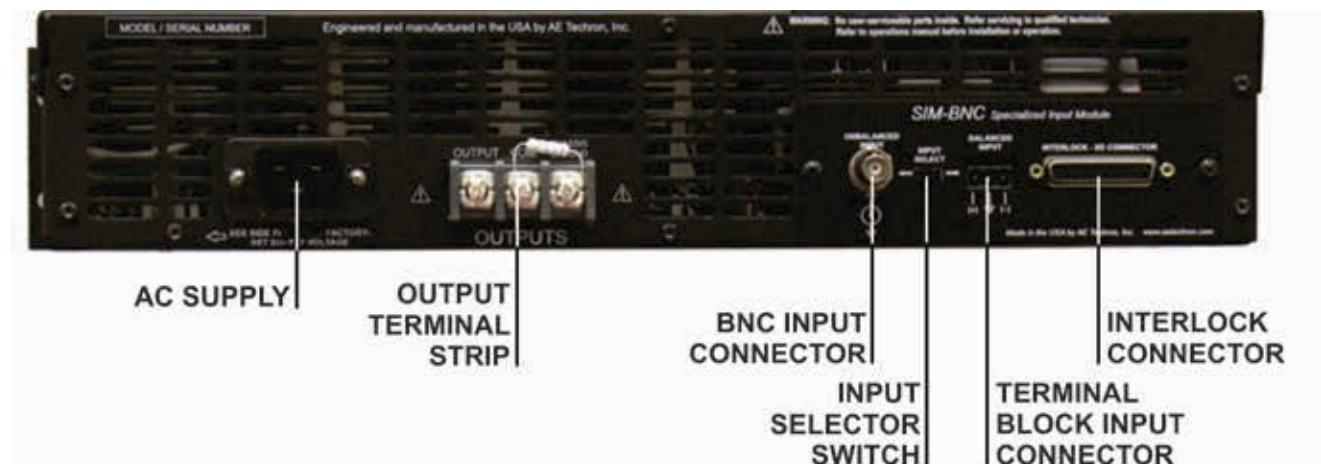

Figure 4.7 – Back Panel Controls and Connectors

5 Advanced Configuration

The 7224/7226 amplifier was designed to offer exceptional versatility in operation. You can choose from a range of field-configurable options, including:

- Operate as a stand-alone amplifier or as part of a multiple-amplifier system.
- Operate with variable gain control or at a fixed gain setting of 20.
- Select Controlled-Current or Controlled-Voltage modes of operation.
- Trigger Standby mode when an overload condition occurs during operation.
- Select the Stop mode state at power-up, or go immediately to the Run mode state at power-up.
- Configure for use in high voltage applications, high current applications, or for applications requiring mid-level amounts of both voltage and current.

Your amplifier has been pre-configured to your specifications before shipping from the factory. These initial settings are detailed on your 7224 or 7226 Proof of Performance sheet and on a label located on the side of the amplifier.

If you need to make changes to your amplifier's configuration, please follow the instructions contained in this chapter.

⚠ WARNING

Do not attempt to access the Main Board or Power Supply Board while the amplifier is running. Turn the amplifier off and disconnect the AC Mains before opening the access panel.

⚠ CAUTION

After turning the amplifier off, let the unit sit for 2 minutes before removing the access panel. This will allow the electrical charge in the Power Supply capacitors to discharge.

5.1 Configuration Access Panel

The 7224/7226 amplifier contains an Access Panel built into the top cover. Most configuration settings can be made through this Access Panel. For your convenience, a #2 Phillips screwdriver is provided in your Toolkit for use in this procedure.

IMPORTANT: Before removing the Access Panel, make sure the amplifier is turned off for at least 3-5 minutes and the AC mains are disconnected.

1. Locate the Access Panel as shown in **Figure 5.1**. Make sure that all 8 screws are accessible. Remove the unit from its rack, if necessary.
2. Using a #2 Phillips screwdriver (provided), remove the 8 screws located on the top and side of the amplifier.
3. Remove the Access Panel and set it aside.

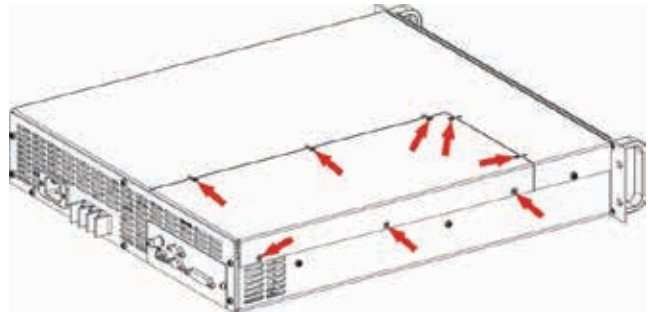

Figure 5.1 – Access Panel Screw Locations

5.2 Configuration Settings Located on the Main Board

The following custom settings can be made via jumper settings on the Main Board, which is located inside the Access Panel compartment, as shown in **Figure 5.2**.

- Master/Slave setting for stand-alone or multiple-amplifier systems.
- Variable or Fixed Gain setting.
- Controlled Current/Controlled Voltage setting.

- Compensation setting to select RC network when operating in Controlled Current mode.
- Stop Mode/Run Mode setting for selection of power-up state.
- Standby mode on Over Load setting to trigger Standby mode when amplifier senses an Overload state.

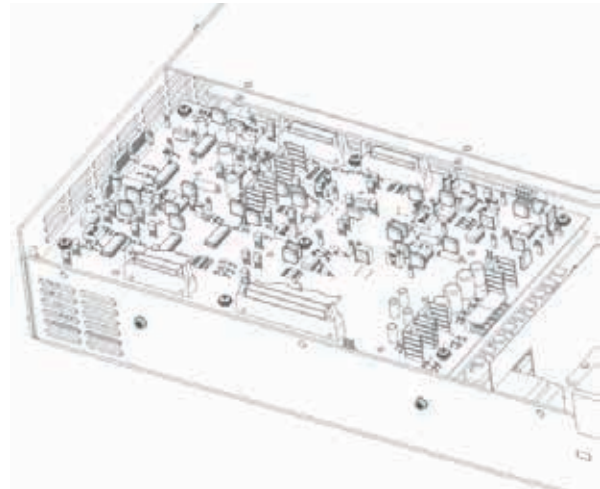

Figure 5.2 – Main Board Location Inside Access Panel

5.2.1 Master/Slave Setting

To enable the amplifier for use as a single amplifier or as the Master amplifier in a multi-amplifier system, set jumpers **P1** and **P2** in the **Master** position (jumpers across top two pins of each set). The Master setting is the factory default. To enable the amplifier for use as a Slave amplifier in a multi-amplifier system, set jumpers **P1** and **P2** in the **Slave** position (jumpers across bottom two pins of each set). See **Figure 5.3**.

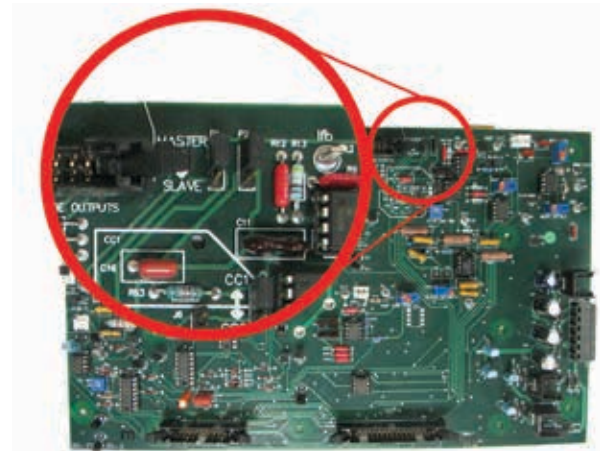

Figure 5.3 – Master/Slave Setting

For complete information on multi-amp system configuration and wiring, please consult the **AE Techron Multi-Amp Configuration Guide** available for download from the AE Techron website at www.aetechron.com.

5.2.2 Fixed Gain/Variable Gain Setting

The 7224/7226 amplifier ships with an enabled Gain Control knob (located on the amplifier front panel). To disable the **Variable Gain** control and set for a **Fixed Gain of 20**, locate and unplug the red connector from jumper **J10**. Then place a **jumper on the left two pins** at that location. See **Figure 5.4**.

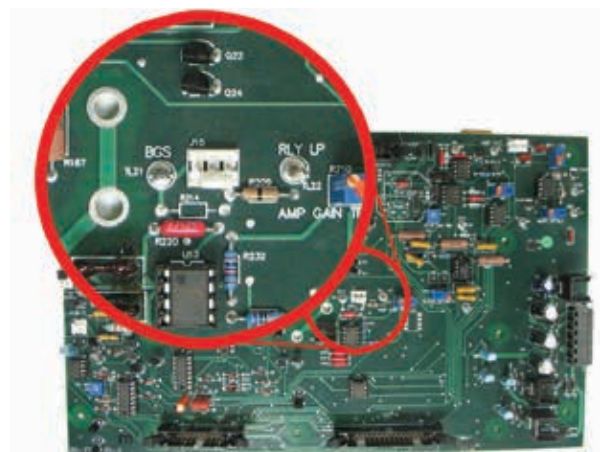

Figure 5.4 – Gain Trim Control



CAUTION

In Controlled-Current Mode, the load is part of the amplifier circuit, and the relationship of the load to the amplifier is critical. For proper and safe operation in Controlled-Current mode, you must observe the following guidelines:

1. **Properly attach a load before operating the amplifier.**
2. **DO NOT use a blocking capacitor.** The load must have a DC path.

3. **Never leave the load open.** If you feel the load must be fused, which could lead to a potential open circuit, please contact AE Techron Application Engineering department.
4. **Check to make sure the load has some inductive component.**
5. **Provide appropriate Compensation for the load.**
6. **If oscillation occurs, turn off the amplifier immediately.**

Failure to follow these guidelines may result in damage to the amplifier or load.

5.2.3 Controlled-Voltage/ Controlled-Current Mode Setting

To allow the amplifier's output voltage to be controlled by its input voltage signal, place jumper **J4** in the **Right** position. To allow the amplifier's output current to be controlled by its input voltage signal, place jumper **J4** in the **Left** position. See **Figure 5.5**. For more information on Controlled-Current operation, see the **"Applications"** section of this manual.

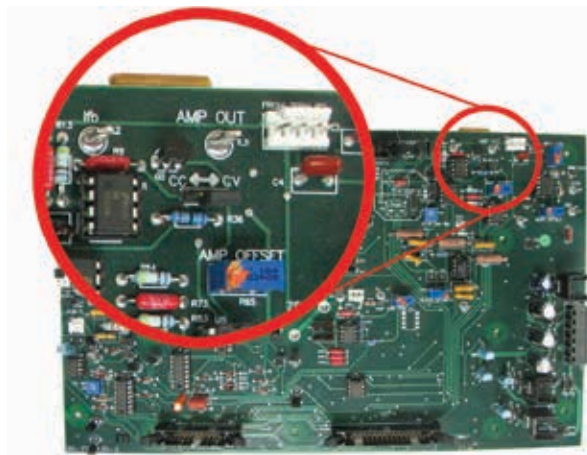

Figure 5.5 – Controlled-Voltage/
Controlled-Current Mode Setting

5.2.4 Compensation Setting (Controlled-Current Mode)

When a 7224 or 7226 amplifier is used in Controlled-Current mode, the current control loop is tuned with one of two available RC networks. Place jumper **J5** in the **Up** position to select **CC1** network. Place jumper **J5** in the **Down** position to select **CC2** network. See **Figure 5.6**. For more information on Controlled-Current operation, see the **"Applications"** section of this manual.

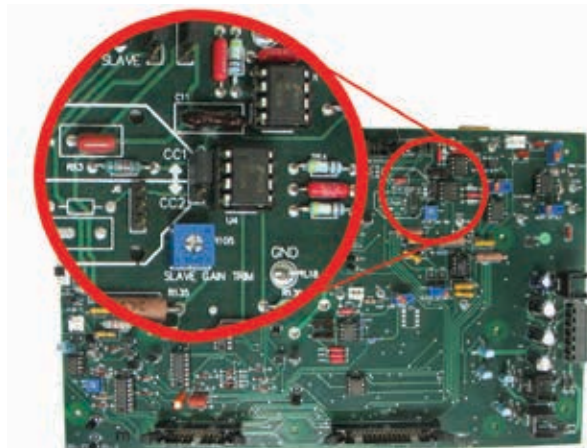

Figure 5.6 – Compensation Setting

5.2.5 Run Mode/Stop Mode on Power-Up Setting

The amplifier will power-up to **Run Mode** when jumper **J11** is in the **Left** position (default setting). To cause the amplifier to enter **Stop Mode** on power-up, place jumper **J11** in the **Right** position. See **Figure 5.7**.

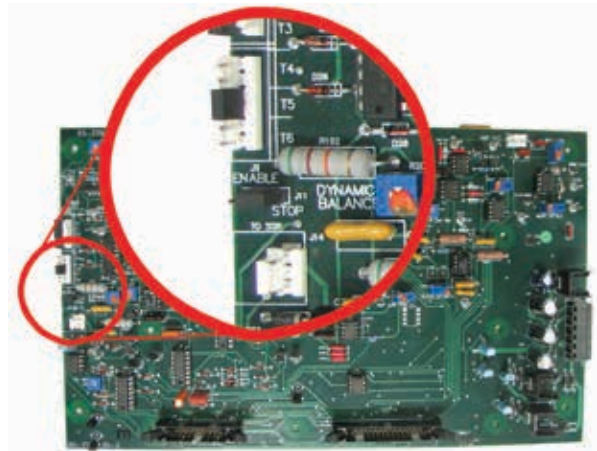

Figure 5.7 – Run Mode/Stop Mode on Power-Up Setting

5.2.6 Standby on Overload Setting

When this latch is enabled, the amplifier will move into Standby mode when it senses an activation of the IOC (Input/Output Comparator) Distortion Alert circuit. The IOC Distortion Alert circuit continuously compares the input waveform to the output waveform. When a distortion of more than 0.5% occurs, the IOC circuit will activate. The amplifier will remain in Standby Mode until the Reset switch on the front panel is pushed or a Reset signal is received on the Interlock – I/O Connector. Once reset, the amplifier will return to Run mode. To enable **Standby mode on Over Load**, place the jumper across the two pins labeled **J13**. See **Figure 5.8**.

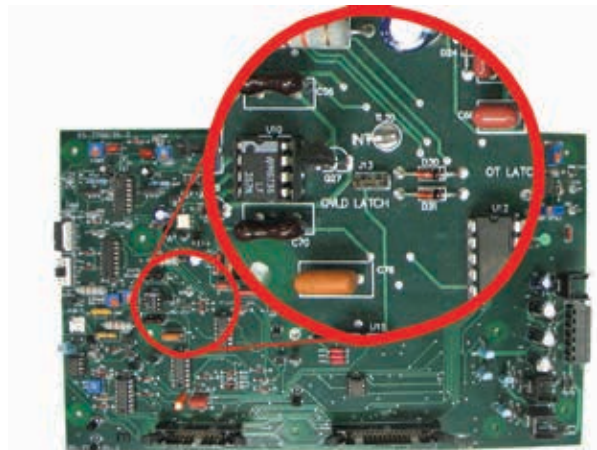

Figure 5.8 – Standby Mode on Over Load Setting

5.3 Configuration Settings Located on the Power Supply Board

The following custom settings can be made via plug-in connectors located on the Power Supply Board:

- Amplifier Voltage Potential setting (high current or high voltage)
- Bi-Level Power Supply setting

5.3.1 Accessing the Power Supply Board

To access the Power Supply Board, follow the instructions given at the beginning of this Section to

open the Configuration Access Panel. The Power Supply Board is located to the right of the Main Board, as shown in **Figure 5.9**.

5.3.2 Changing Amplifier Voltage Potential

The amplifier can be configured for High Current (90V) or High Voltage (180V) operation via user-selectable plugs on the Power Supply Board. Complete the following steps to change the amplifier voltage potential.

1. Locate the two XFMR sections (left of Line Voltage sections) (see **Figure 5.10**).
2. For High Current (90V) Output (see **Figure 5.11**).
3. For High Voltage (180V) Output (see **Figure 5.12**).

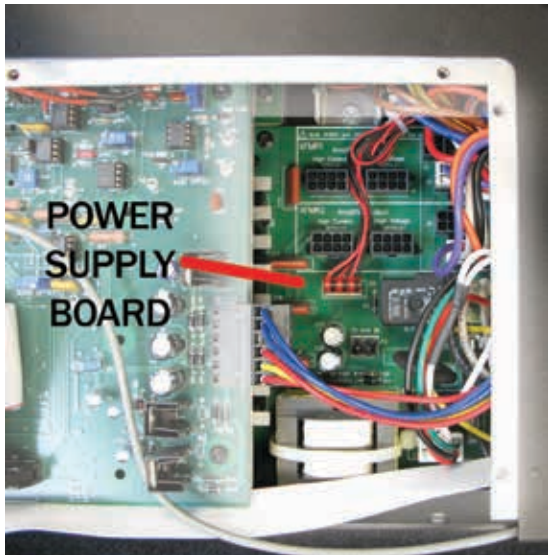

Figure 5.9 – Accessing the Power Supply Board

5.3.3 Changing Bi-Level Power Supply Function

The amplifier provides three Bi-Level switch settings: Automatic, High, or Low. The user can select between settings via a switch on the Power Supply Board.

To access and change the Bi-Level Power Switch, follow these steps:

1. Locate the SIM Input Card on the right side of the rear panel of the amplifier.
2. Using a #2 Phillips screwdriver (provided), remove the 2 screws located at the edges of the SIM card.
3. Keeping the ribbon cable attached, remove the SIM card from the amplifier until it is completely clear from the card bay.
4. Locate Bi-Level Power Switch, S1, a black, three-position switch at the rear of the card bay. (See **Figure 5.13**)
5. Move Black switch to desired setting. If necessary, use a pointed, non-metallic object (such as a pen) to help in moving the switch.

- a. Automatic – Left
- b. Low – Middle
- c. High – Right

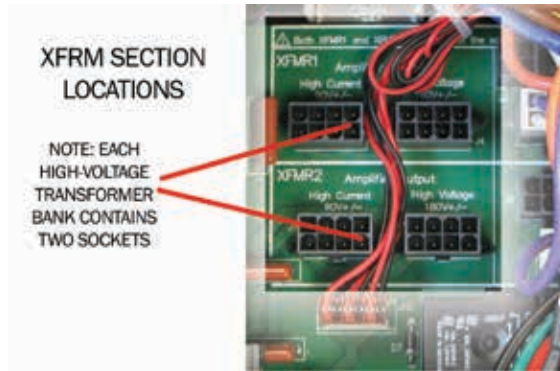

Figure 5.10 – Location of Amplifier High-Voltage Transformer Sockets

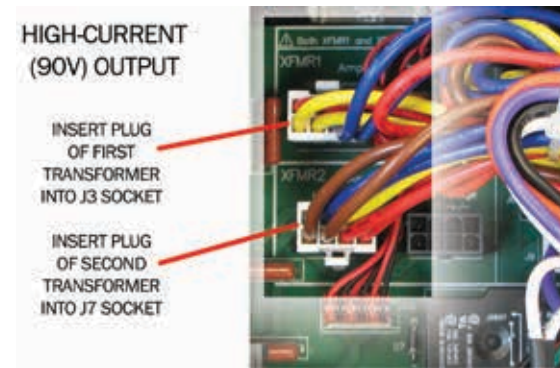

Figure 5.11 – J3 and J7 Plug Locations for High-Current Output

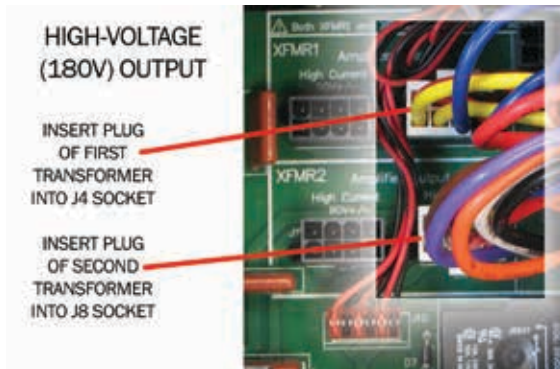

Figure 5.12 – J4 and J8 Plug Locations for High-Voltage Output



Figure 5.13 – Bi-Level Power Switch Location

5.3.4 Selecting the Best Voltage Potential and Bi-Level Power Switch Settings for Your Application

The output of the amplifier will be determined by the combination of settings used for both Voltage Potential and Bi-Level Power Switch.

OUTPUT VOLTAGE

BI-LEVEL SWITCH SETTING	VOLTAGE POTENTIAL SETTING	
	High Current (90V)	High Voltage (180V)
AUTO	45 - 90	90 - 180
HIGH	90	180
LOW	45	90

Use the following general guidelines to select the best combination of settings to fit your requirements:

OUTPUT	LOAD		Settings
	Continuous	Pulse	
High Voltage	16, 8 ohm	16, 8, 4 ohm	180 V Auto
Mid-Level	4, 2 ohm	2, 1 ohm	90 V Auto
High Current	1, 0.5 ohm	0.75 - 0.25 ohm	90 V Low

Also see the **“Specifications”** section for more information.

6 Applications

6.1 Remote Status and Control using the SIM Interlock I/O Connector

The procedures outlined in this section assume competence on the part of the reader in terms of amplifier systems, electronic components, and good electronic safety and working practices.

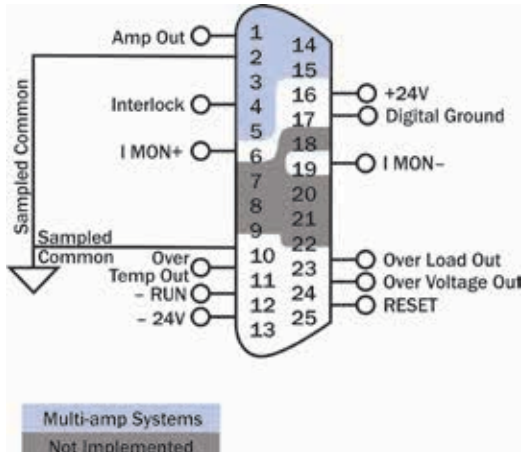

Figure 6.1 – Remote Status and Control Pinouts

AE Techron 7224/7226 amplifiers come with a SIM-BNC input module that also contains a female, 25-pin D-Sub connector. This connector can be used to provide remote control and monitoring of the amplifier.

The information provided here will instruct you in the wiring of several control and status applications including:

- Remote Enable / Standby control
- Run/Standby status
- Over-temperature status
- Overload status
- Overvoltage status
- Reset after Overload error
- Voltage monitor
- Current monitor

Figure 6.1 maps the pins used for these applications.

For a detailed chart of all DB-25 pinouts, see **“Appendix 1.”**

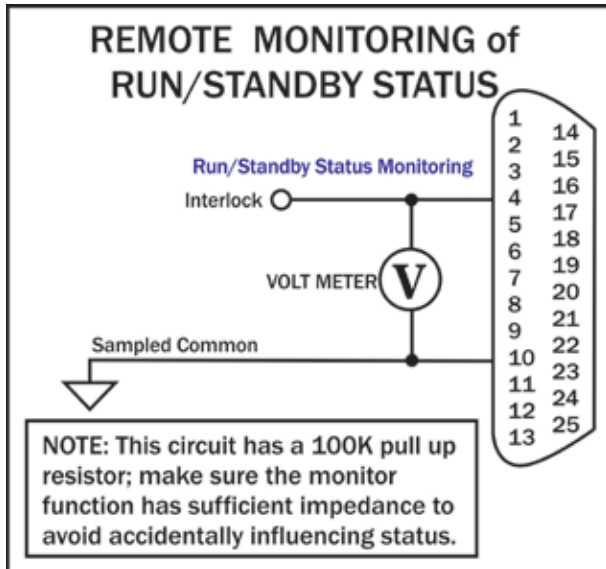

Figure 6.2 – Remote Run/Standby Monitor

6.1.1 Remote Run/Standby Status Monitor

Using the SIM-BNC Interlock connector located on the back panel of the amplifier, you can remotely monitor the Run/Standby status of the amplifier.

Remote Run/Standby Status

Purpose: Use a voltage meter to monitor the status of the amplifier to determine if the amplifier is in a “Run” or “Standby” state.

Method: Connect a voltage meter to monitor the circuit voltage. Connect across PIN 4 (Interlock) and PIN 10 (Sampled Common).

When the voltage meter reads greater than 10V, the amplifier is in the Run state; when the meter reads less than 10V, the amplifier is in the Standby state. See **Figure 6.2.**

Signal Type: DC

Level when Asserted: >10 V

Level when Deasserted: <10 V

IMPORTANT: This circuit has a 100K pull-up resistor. Make sure the monitor function has sufficient impedance to avoid accidentally influencing status.

6.1.2 Remote Amplifier Status and Reset

The SIM Interlock I/O Connector can be used to create a circuit to monitor remotely one or more amplifier conditions, including Run status, Over-temperature, Overload and Overvoltage. The circuit can also be constructed to allow remote reset of the amplifier when it is forced to Standby due to Over-load conditions.

Use a male, 25-pin D-Sub connector and high-quality wire to build the circuit. **Figure 6.3** schematic details the circuit and components required for all status and reset functions.

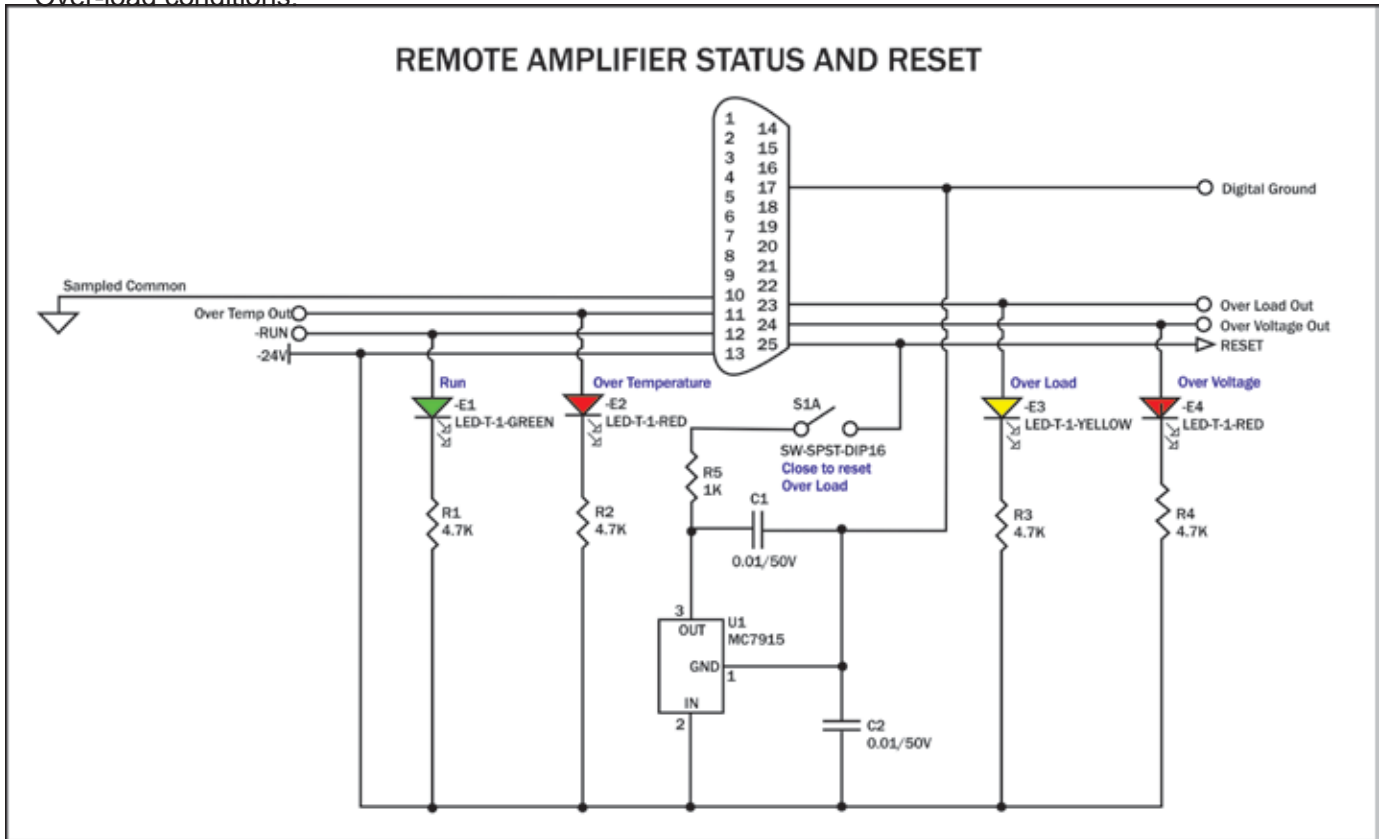

Figure 6.3 – Remote Status and Reset Schematic

Remote Signal of Over Temperature Condition

Purpose: LED, when lit, signals Over Temperature condition.

Method: Use a 6mA series resistor of 4.02 Kohm for LED or OPTO, tie OverTemp Out (PIN 11) to -24V source (PIN 13).

Signal Type: DC

Level when Asserted: -24V

Level when Deasserted: 0V

Note: When amp is normal, this pin is pulled to -24V through a 47.5K-ohm resistor; when amp is in OverTemp state, transistor Q37 turns on and sources chassis ground as an output. Do not exceed 20 milliamps.

An OverTemp condition will force the amp to Standby. The amplifier will automatically move to Run when temperature cools to operating levels.

Remote Signal of Run Condition

Purpose: LED, when lit, signals Run state.

Method: Use a 6mA series resistor of 4.02K-ohm for LED or OPTO, tie Run (PIN 12) to –24V source (PIN 13).

Signal Type: DC

Level when Asserted: –24V

Level when Deasserted: 0V

Remote Signal of OverLoad Condition

Purpose: LED, when lit, signals Overload condition.

Method: Use a 6mA series resistor of 4.02K-ohm for LED or OPTO, tie OverLoad Out (PIN 23) to –24V source (PIN 13).

Signal Type: DC

Level when Asserted: –24V

Level when Deasserted: 0V

Note: When amp is normal, this pin is pulled to –24V through a 47.5K-ohm resistor; when amp is in Overload state, transistor Q36 turns on and sources chassis ground as an output. Do not exceed 20 milliamps.

An Over Load condition will not place the amplifier in Standby when operating with the factory default settings. In order to clear the fault condition, reduce the input levels until the Over Load LED turns off. However, if the Standby Mode on Over Load option is set, an Over Load condition will force amp to Standby. To return the amplifier to Run mode, reduce the input signal level, then trigger a Reset command using the front-panel Reset button or a remote amplifier Reset command.

Remote Signal of OverVoltage Condition

Purpose: LED, when lit, signals Overvoltage condition.

Method: Use a 6mA series resistor of 4.02K-ohm for LED or OPTO, tie OverVoltage Out (PIN 24) to –24V source (PIN 13).

Signal Type: DC

Level when Asserted: –24V

Level when Deasserted: 0V

Note: When amp is normal, this pin is pulled to –24V through a 47.5K-ohm resistor; when amp is in Overvoltage state, transistor Q29 turns on and sources chassis ground as an output. Do not exceed 20 milliamps.

Reset from Standby

Purpose: Switch, when thrown, returns amp to Run condition after an Overload condition.

Method: Use a dry-contact switch, voltage regulator (MC7915), and two 0.01/50V capacitors; wire the circuit as shown (above). Assert 15V for at least 100 ms to clear the error condition.

Signal Type: DC

Level when Asserted: –15V

Level when Deasserted: 0V

Note: Tie to PIN 13 (–24V dc) and create a –15V dc source; <2mA required for reset. Connect the –15V dc source to PIN 25 (Reset) through a 1K buffer resistor to reset.

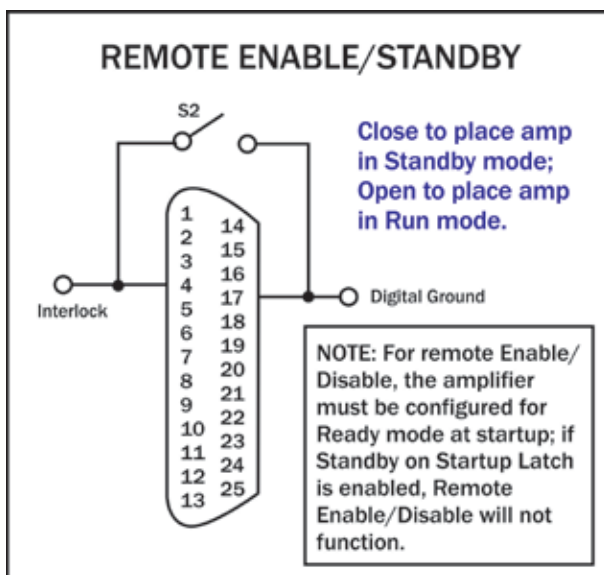

Figure 6.4 – Remote Enable/Standby

6.1.3 Remote Enable/Standby

Using the SIM-BNC Interlock connector located on the back panel of the amplifier, you can remotely Enable the amplifier and/or place the unit in Standby mode. See **Figure 6.4**.

Remote Enable/Standby

Purpose: Use a switch or optocoupler to remotely disable the amplifier and place it in Standby mode. Also, return the amplifier from Standby mode to the Run condition.

Method: Short PIN 4 of amplifier to Digital Ground (PIN 17) using a dry contact switch or optocoupler. In multi-amp applications, a switch can be used for Parallel systems, but an optocoupler must be used for Series systems. Multiple amplifiers (sharing the same Sampled Common power connections) can be simultaneously forced to Standby by daisy-

chaining Interlock (PIN 4) across amps.
 When Interlock (PIN 4) is shorted to Digital Ground (PIN 17), amplifier is placed in Standby mode.
 When switch is open, amplifier is released to the Run condition.

Signal Type: DC

Level when Asserted: 0 to 8 V

Level when Deasserted: 10 to 15 V

IMPORTANT: The amplifier must be configured for Ready mode at startup (factory default) or the Run button must be pressed at the amplifier front panel at startup. The Remote Enable/Standby circuit will not function if the Startup to Standby Latch has been activated on the amplifier.

6.1.4 Remote Monitoring of Current

Using the SIM-BNC Interlock connector located on the back panel of the amplifier, you can remotely monitor current output.

Remote Monitoring of Current Output

Purpose: Use a voltage meter to monitor output current.

Method: Connect a voltage meter to monitor the output current being produced by the amplifier. Connect across PIN 6 (I MON+) and PIN 10 (Sampled Common). See **Figure 6.5**.

Signal Type: DC

Level: 5A/V

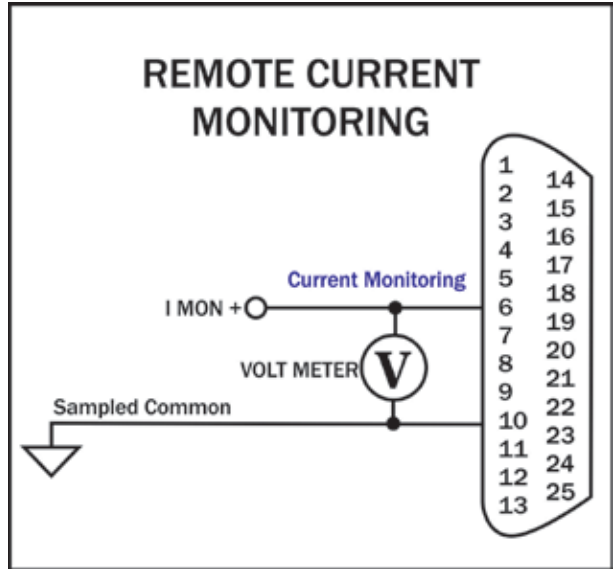

Figure 6.5 – Remote Current Monitoring

Remote Monitoring of Current Output - Alternate Method

Purpose: Use a voltage meter to monitor output current when output is not balanced.

Method: Connect a voltage meter to monitor the output current being produced by the amplifier. Connect across PIN 6 (IMON+) and PIN 19 (IMON-). See **Figure 6.6**.

Signal Type: AC

Level: 2.5A/V

CAUTION: To avoid ground loops, isolation from ground must be provided. Use of a differential probe is recommended.

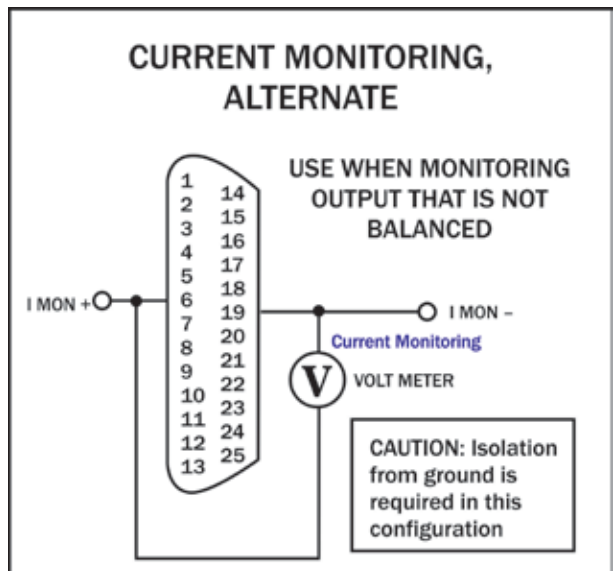

Figure 6.6 – Remote Current Monitoring, Alternate Method

6.2 Controlled Current Operation

The procedures outlined in this section assume competence on the part of the reader in terms of amplifier systems, electronic components, and good electronic safety and working practices.

6.2.1 Controlled-Voltage vs. Controlled-Current Modes of Operation

AE Techron 7224/7226 amplifiers can be field-configured to operate as **Voltage Amplifiers** (Voltage-Controlled Voltage Source) or as **Transconductance Amplifiers** (Voltage-Controlled Current Source). The mode selection is made via a jumper setting located on the amplifier main board. See the “**Advanced Configuration**” section for more information.

When configured as a **Controlled-Voltage** source (voltage amplifier), the amplifier will provide an output voltage that is constant and proportional to the control (input) voltage. If the load's impedance changes, the amplifier will seek to maintain this ratio of input to output voltage by increasing or decreasing the current it produces, as long as it is within the amplifier's ability to create the required current. Use this mode if you want the output voltage waveform to be like the input waveform (see **Figure 6.7**).

Conversely, when configured as a **Controlled-Current** source (transconductance amplifier), the amplifier will provide an output current that is constant and proportional to the control (input) voltage. If the load's impedance changes, the amplifier will seek to maintain this transconductance (ratio of input voltage to output current) by increasing or decreasing the voltage it produces, as long as it is within the amplifier's ability to create the required voltage. Use this mode if you want the output current waveform to be like the input waveform (see **Figure 6.8**).

6.2.2 Safety and Operation Considerations for Controlled Current Operation

When an AE Techron amplifier is configured as a Controlled Current source, care needs to be

CONTROLLED-VOLTAGE MODE

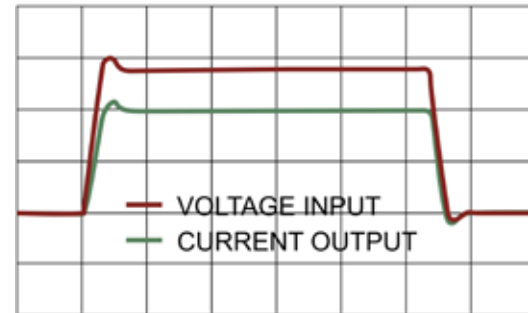

Figure 6.7 – Input to Output Comparison, Controlled-Voltage Operation

CONTROLLED-CURRENT MODE

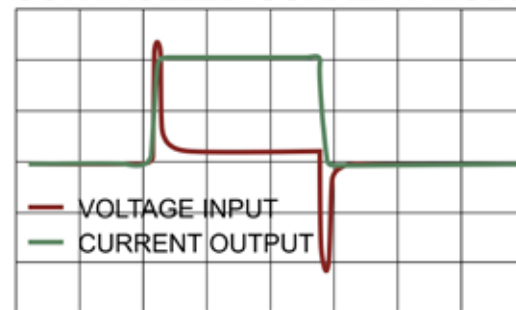

Figure 6.8 – Input to Output Comparison, Controlled-Current Operation

exercised in its operation. **Any voltage controlled current source should never be turned on without a load, (with some impedance, real or effective) connected to its output terminals.**

When asked to operate in this way, any current source (including an AE Techron amplifier) will increase its output voltage in an attempt to drive the requested current into the load. In an open-circuit condition, creating current flow will be impossible. The current source will increase its output voltage until it reaches its voltage limit. This is a potentially dangerous condition for both the AE Techron amplifier and for any user who might come in contact with the amplifier output terminals.

When operating in Controlled Current (CC) mode, a compensation circuit is required to ensure accurate output current. Since the load is a critical circuit component in CC mode, the inductive and resistive values of the load will determine the required compensation values. While the factory-

default compensation setting will be sufficient for some applications, the compensation setting may also be adjusted in the field. The following section describes methods for determining and setting proper compensation when operating in Controlled-Current mode.

6.2.3 Controlling Compensation for CC Operation

AE Techron 7224/7226 amplifiers can be configured for either Controlled Voltage (CV) or Con-

trolled Current (CC) mode of operation. When operating the amplifier in Controlled Voltage (CV) mode, compensation is not required. However, when operating in Controlled Current (CC) mode, the amplifier load becomes an integral part of the system. In order to ensure system stability and to control available bandwidth, compensation via an RC network is required for CC operation. The following steps will allow you to compensate your amplifier for operation in CC mode safely and effectively.

STEP 1: Check Amplifier Operation in CV mode.

We recommend that you power-up and enable the amplifier in Controlled Voltage mode without attaching a load before configuring your amplifier for Controlled Current operation. This will allow you to verify that the input signal and the amplifier are operating correctly.

Once this initial check is completed, power down the amplifier and access the amplifier main board to place the amplifier in CC mode. (Refer to the “*Advanced Configuration*” section for more information.)

One of two compensation settings can be selected via jumpers on the main board: CC1 which en-

ables the factory-installed RC network (see **Figure 6.9**), or CC2 which allows installation of a custom RC network.

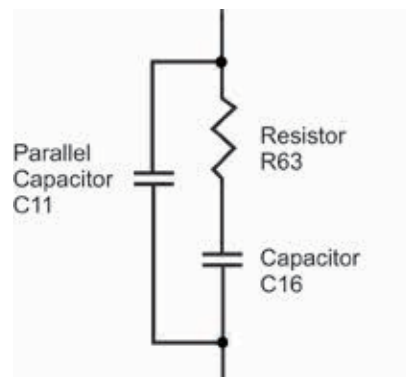

Figure 6.9 – Factory-installed Default RC Network

STEP 2: Determine Required Compensation.

When operating an amplifier in Controlled Current mode, the load becomes an integral part of the system. In order to determine the required compensation for your load, begin by consulting

the following table to determine the approximate compensation capacitance (C) required based on the inductance of your load:

	Load Inductance (L)		
	<200 μ H	<>200 μ H – <1 mH	>1 mH
Compensation Capacitance (CC)	0.001 μ F	0.01 μ F	0.1 μ F

NOTE: Load Resistance (R) is assumed to be <5 ohms.

STEP 3: Determine if Default or Custom Compensation is Required.

If your load inductance is between 200 microHenries and 1 milliHenry, and your load resistance is less than 5 ohms, then you can likely use the default compensation provided by the amplifier's factory-installed RC network. To select the factory-default compensation, please see **STEP 4** below.

If your load inductance falls outside of the mid-range, or if your load resistance is greater than 5 ohms, then you must calculate your required compensation. If, after calculating your required compensation, you determine that the default compensation will be insufficient for your load, then you will need to enable and install a custom RC network. See **STEP 6** below.

STEP 4: Enabling Your Compensation Setting.

AE Techron 7224 or 7226 amplifiers can be enabled with one of two compensation settings: default RC network or custom RC network. The required network can be selected via jumpers on the main board. CC1 enables the default (factory-installed) RC network, while CC2 allows installation of a custom RC network. **Figure 6.9** describes the default RC circuit.

To select CC1, place jumper J5 in the UP position; to select CC2, place jumper J5 in the DOWN position. (For jumper location, see the “**Advanced Configuration**” section.)

IMPORTANT: If CC2 is selected, you must calculate the compensation requirements for your custom RC network and install the network on your amplifier main board before operating the amplifier in CC mode.

STEP 5: (Optional) Verify Suitability of Default Compensation (CC1)

If desired, the following values of the components contained in the default RC network can be used with the formulas provided in **STEP 6** below to verify the suitability of the default compensation for your uses.

Pins Jumped: 1 and 2 (UP)

Compensation Resistor: R63 (68 Kohms)

Compensation Capacitor: C16 (0.047 μ F)

Parallel Capacitor: C11 (47 pF)

STEP 6: Installing an RC Network for Custom Compensation

If the default RC network does not provide suitable compensation for your intended load, you will need to install a custom RC network that is matched to your load. This network will require two components (a resistor (R) and a capacitor (C)) to be installed on the main board. To calculate the approximate values required for each component, use the following formulas.

COMPENSATION FORMULAS:

To find the value for the resistor (Rc) in the RC network:

$$R_c = 20,000 \times 3.14 \times L \times BW$$

where:

Rc is compensation resistance in ohms.

L is load inductance in henries.

BW is bandwidth in hertz.

To find the value for the capacitor (Cc) in the RC network:

$$C_c = L / (R \times R_c)$$

where:

Cc is compensation capacitance in farads.

L is load inductance in henries.

R is resistance of load in ohms.

Rc is compensation resistance in ohms.

STEP 7: Optimizing the Compensation Values.

Once an approximate R_c and C_c have been computed, these values will need to be evaluated. To do this, install components with the required values in the main board at locations R82 and C25 as shown in **Figure 6.10**.

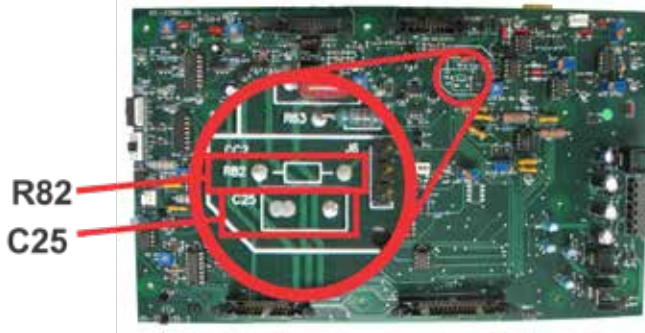

Figure 6.10 – Custom Compensation Location

Remember the load you are connecting is a part of the system and the amplifier should not be turned on without the load being connected.

After installing the components, check to ensure that jumper J5 is correctly installed (see **STEP 4**), then power up the amplifier without signal input.

To begin testing, input a square wave with a frequency of 100 Hz to 1 kHz, or a squared pulse at a low level (typically 0.25 to 2.0 volts). A limited-rise-time, repetitive pulse of low duty cycle is preferred.

Observe the output current through a current monitor or current probe. Look for clean transition edges. The presence of ringing or rounding on the transition edges indicates compensation problems. (See **Figure 6.11**.)

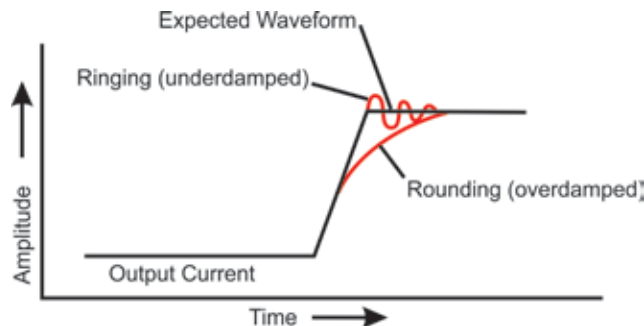

Figure 6.11 – Compensation Effects on Waveform

If a change in compensation is necessary, an adjustment to the resistor component of the Compensation circuit is probably required.

If the output current waveform is ringing, the circuit is underdamped: You have too much gain and should lower the resistance (see **Figure 6.12**).

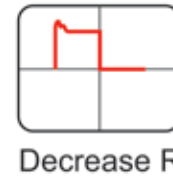

Figure 6.12 – Square Wave Showing a Decrease in R is Required

If the output current waveform is rounded, the circuit is overdamped: You have too little gain and should increase resistance (see **Figure 6.13**).

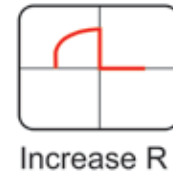

Figure 6.13 – Square Wave Showing an Increase in R is Required

If the output current waveform is neither underdamped or overdamped, but the top of the squarewave is not level, then you should instead decrease the capacitor value (see **Figure 6.14**).

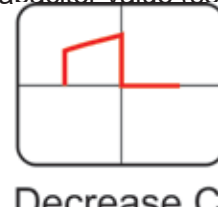

Figure 6.14 – Square Wave Showing a Decrease in C is Required

When making adjustments:

Resistor: Increase or decrease resistance values in increments of +/- 10%.

Capacitor: Incrementally decrease capacitor values by a factor of 2 or 3.

After final adjustments have been made to the circuit, the final waveform for your planned application should be tested to confirm the amplifier's compensation setting.

NOTE:

- If possible, use 1% metal film resistors. AE Techron discourages installation of potentiometers in the resistor location of the compensation

circuit because this can decrease stability and may increase inductance.

- The parallel capacitor in the RC network serves to increase stability but can be removed, if it is not required for system stability. If the parallel capacitor is used, it will usually decrease the value of resistance needed.
- In multiple amplifier systems, expect to decrease the value of R63 in series systems by 1/2.

6.3 Multi-amplifier Systems

7224 and 7226 amplifiers may be used with other amplifiers of the same model to increase voltage or current (7224 amplifiers with other 7224 amplifiers, or 7226 amplifiers with other 7226 amplifiers). Because the internal circuitry of these amplifiers is not connected to chassis ground, these amplifiers are well suited for use in series or parallel systems.

Up to three amplifiers may be configured in series, and up to four may be configured in parallel. Configurations with more amplifiers may be possible, depending on the application. Please contact AE Techron **Application Support** for information on these more complex multi-amp systems.

6.3.1 Accessories for Multiamp Systems

For routine, controlled-voltage applications, Series or Parallel systems can be configured using the following accessories available from AE Techron:

SIM-OPTOC – The SIM-BNC-OPTOC Specialized Input Module allows multiple 7224 or 7226 amplifiers to be configured as a series output system to increase the available output voltage to the load. The SIM-BNC-OPTOC kit also includes a BNC connector safety cover.

The SIM-BNC-OPTOC module is required for all Series configurations and should be used in conjunction with the DB9M CABLE (see below).

DB9M CABLE – The DB9M (OPTOC) CABLE is a high-voltage Interlock cable that provides superior insulation for multi-amp series systems running high-voltage applications.

The DB9M CABLE is required for all Series configurations and should be used in conjunction with the SIM-BNC-OPTOC module (see above)

7224/7226 BALLAST RESISTOR KIT – Ballast resistors are required for all Parallel configurations. The ballast resistor kits include one ballast resistor with connection terminals and mounting hardware. The 7224/7226 BALLAST RESISTOR KIT also contains the shunt required to defeat the amplifier's external level control.

PARALLEL WIRING KITS – Three types available: 7224/7226 2-AMP, 7224/7226 3-AMP, and 7224/7226 4-AMP. Parallel wiring kits include the DB-25 Interlock cable for system communication, BNC T-connectors and BNC patch cables for wiring parallel inputs through the BNC input connectors, and the output wiring for connecting system amplifiers to the load. The kits also include the wire(s) needed for wiring the parallel inputs through the Removable Barrier Block (WECO) connectors and the input terminators required during system setup. Parallel wiring kits are recommended for all Parallel configurations.

6.3.2 Multiamp System Configuration

The AE Techron **7000-Series Multi-Amp Configuration Guide** provides step-by-step instructions or for configuration and hookup of a multi-amp system using 7224 or 7226 amplifiers. This guide can be found on the USB drive included with the amplifier and can also be downloaded from the AE Techron website at www.aetechron.com.

6.3.3 Accessory Recommendations by System Type

Series Systems	Parallel Systems
<p>7224 or 7226 Two in Series: (2) SIM-BNC-OPTOC input cards, (1) DB9M OPTOC cable</p> <p>7224 or 7226 Three in Series: (3) SIM-BNC-OPTOC input cards, (2) DB9M OPTOC cables</p>	<p>7224 or 7226 Two in Parallel: (2) 7224/7226 BALLAST RESISTOR kits, (1) 7224/7226 2-AMP Parallel Wiring kit</p> <p>7224 or 7226 Three in Parallel: (3) 7224/7226 BALLAST RESISTOR kits, (1) 7224/7226 3-AMP Parallel Wiring kit</p> <p>7224 or 7226 Four in Parallel: (4) 7224/7226 BALLAST RESISTOR kits, (1) 7224/7226-AMP Parallel Wiring kit</p>

6.3.4 Multiamp System Operation

In multiamp systems, the Master amplifier controls several operating functions for all amplifiers included in the system, so Slave amplifiers are said to be “interlocked” with the Master amplifier. The functions controlled by the Master amplifier include input signal, operating status, mode of operation (controlled-voltage or controlled-current operation) and amplifier compensation.

Because the amplifiers in a multiamp system are interlocked, the main and fault status indicators of all amplifiers in the system must be considered to determine the current status and the necessary remedies to return the system to operational status when a fault condition occurs.

Enable, Stop and Reset Buttons

The following details the results when each of the three Push Buttons are pressed on an amplifier front panel in a multi-amp system.

Enable – In multi-amp systems that have been configured to start up in Run mode (factory default setting), when an amplifier is powered on, the amplifier will be placed in Remote Standby mode (Ready and Standby LEDs lit) and remain in Remote Standby mode until all amplifiers in the system have been powered on. The system will automatically proceed to Run mode when all am-

plifiers in the system are powered on and achieve Remote Standby mode.

In multi-amp systems that have been configured to start up in Stop mode, when an amplifier is powered on, the amplifier will be placed in Standby/ Stop mode (Stop and Standby LEDs lit). When the Enable button is pressed on each amplifier, that amplifier will be placed in Remote Standby mode (Ready and Standby LEDs lit) and remain in Remote Standby mode until all amplifiers in the system have been Enabled. The system will automatically proceed to Run mode when all amplifiers in the system achieve Remote Standby mode.

Stop – Pressing the Stop button on any amplifier in the system will place that amplifier in Standby/ Stop mode and place all other amplifiers in the system in Remote Standby mode.

Reset – Pressing the Reset button on the amplifier reporting a fault condition will return all of the amplifiers to Run mode if the condition causing the fault condition has been cleared and the amplifier has been configured for startup in Run mode. However, pressing the Reset button on other amplifiers in the system (not reporting a fault condition) will NOT clear the fault condition. Refer to the “**Fault Status Indicators**” section for information

on how to clear fault conditions and restore amplifier operation.

If the amplifier reporting the fault condition has been configured for startup in Stop mode, pressing the Reset button will place the amplifier in Standby/Stop mode. Press the Enable button to return the amplifier system to Run mode.

Main Status Indicators for Multi-amplifier Systems

The Main Status indicators on each amplifier in a multi-amp system are used to determine the

operational status of the amplifier. When evaluated along with the statuses of other amplifiers in the system, the Main Status indicators can be used to determine the system status and the action required to return the system to Run mode. See **Figure 6.15**.

Fault Status Indicators for Multi-Amp Systems

The four Fault Status indicators located on each amplifier's front panel are used to monitor the internal conditions of the amplifier and will illumi-

Figure 6.15 – Main Status Indicators for Multi-Amplifier Systems

● ● ● Indicator is lit ● Indicator is not lit ○ Indicator may be lit

Main Status of One or More Amps in the System	Main Status of Other Amps in the System	State of Operation	Action Needed to Return to Run Mode
● Run ● Ready ● Standby ● Stop	● Run ● Ready ● Standby ● Stop	Run mode: All of the amplifiers in the system are in Run mode. The amplifiers' high-voltage transformers are energized and the system will amplify the input signal.	N/A
● Run ● Ready ● Standby ● Stop	● Run ● Ready ● Standby ● Stop	Remote Standby Condition: All of the amplifiers in the system are being held in Standby mode by an external condition. In Remote Standby mode, the amplifiers' low-voltage transformers are energized but the high-voltage transformers are not.	If the amplifiers remain in Remote Standby mode, the system is being held in Standby by remote control through the SIM Interlock I/O connector. Open the Enable/Standby switch to clear this remote Standby condition and return the system to Run mode. See the "Applications" section of this manual for more information on remote amplifier operation.
● Run ● Ready ● Standby ● Stop	● Run ● Ready ● Standby ● Stop	System Not Ready: If one or more of the amplifiers has no LEDs lit, the amplifier has no power or has not been turned on, and the other amplifiers in the system will be held in Standby mode. In Standby mode, the amplifier's low-voltage transformer is energized but the high-voltage transformers are not.	Make sure all amplifiers have AC power and have been turned on. When all amplifiers attain Standby status, all amplifiers in the system will simultaneously be placed in Run mode.
● Run ● Ready ● Standby ● Stop	● Run ● Ready ● Standby ● Stop	Stop mode: When the Stop button on any amplifier in the system is pressed, that amplifier will enter Stop mode and all other amplifiers will enter Remote Standby mode. The system may also enter Stop mode after powering up if one or more amplifiers in the system is configured to enter Stop mode on startup. In Stop mode, the amplifier's low-voltage transformer is energized but the high-voltage transformers are not.	To release the system from Stop mode, press the Enable button on the amplifier displaying the Stop mode status.

nate when a fault condition occurs. All amplifiers in the system may be placed in Standby mode when a fault condition occurs, depending on the fault condition and the configuration of the system. Typically, the system can be released from Standby

mode by pressing the Reset button on the amplifier displaying the Fault status. Refer to the chart in **Figure 6.16** to determine the fault condition being indicated and the action required to clear the fault condition and return the system to Run mode.

Figure 6.16 – Fault Status Indicators for Multi-Amplifier Systems

● ● ● Indicator is lit ● Indicator is not lit ○ Indicator may be lit

One or More Amps in System		Other Amps in System		State of Operation	Action Needed to Clear Fault Condition and Return to Run Mode
Main Status Indicators	Fault Status Indicators	Main Status Indicators	Fault Status Indicators		
<ul style="list-style-type: none"> ● Run ● Ready ● Standby ● Stop 	<ul style="list-style-type: none"> ● Fault ● Over Load ● Over Temp ● Over Voltage 	<ul style="list-style-type: none"> ● Run ● Ready ● Standby ● Stop 	<ul style="list-style-type: none"> ● Fault ● Over Load ● Over Temp ● Over Voltage 	<p>Output Fault status: This indicates that an Output Fault condition has occurred in the amplifier displaying the Fault status, and the system has been placed in Standby mode. The Fault indicator will light under two conditions: 1) High-frequency oscillation is causing high shoot-through current; or 2) An output transistor has shorted, causing the output fault condition.</p>	<p>This fault condition cannot be cleared using the front-panel Reset button. See the “Troubleshooting” section for more information on diagnosing and clearing this fault condition.</p>
<ul style="list-style-type: none"> ● Run ● Ready ○ Standby ● Stop 	<ul style="list-style-type: none"> ● Fault ● Over Load ● Over Temp ● Over Voltage 	<ul style="list-style-type: none"> ● Run ○ Ready ○ Standby ● Stop 	<ul style="list-style-type: none"> ● Fault ● Over Load ● Over Temp ● Over Voltage 	<p>Over Load status: This indicates that the output of the system could not follow the input signal due to voltage or current limits. Under normal operation with the factory-default settings, an Over Load condition will not place the system in Standby mode. If the system has been configured to be forced to Standby on Over Load, the system will be placed in Standby mode when the Over Load indicator lights.</p>	<p>To remedy the Over Load fault during operation, turn down the level of the input signal until the Over Load indicator turns off. To clear an Over Load fault condition when the amplifier is forced to Standby, turn down the level of the input signal, then push the Reset button on the amplifier(s) displaying the Over Load status.</p>

One or More Amps in System		Other Amps in System		State of Operation	Action Needed to Clear Fault Condition and Return to Run Mode
Main Status Indicators	Fault Status Indicators	Main Status Indicators	Fault Status Indicators		
<ul style="list-style-type: none"> ● Run ● Ready ● Standby ● Stop 	<ul style="list-style-type: none"> ● Fault ● Over Load ○ Over Temp ● Over Voltage 	<ul style="list-style-type: none"> ● Run ● Ready ● Standby ● Stop 	<ul style="list-style-type: none"> ● Fault ● Over Load ● Over Temp ● Over Voltage 	<p>Over Temp status: Each amplifier in the system monitors the temperature inside the high-voltage transformers, low-voltage transformer and in the output stage heat sinks. The Over Temp indicator will light and the system will be placed in Standby mode when the temperature sensors detect a condition that would damage the amplifier system. If the Over Temp pulse is extremely short, as in the case of defective wiring or switches, the Over Temp LED may be lit too briefly to observe.</p>	<p>To reset after an Over Temp fault has occurred, make sure the amplifier fans in all amplifiers are running, and then remove the input signal from the system. Allow the fans to run for about 5 minutes. Then push and hold the Reset button on any amplifier displaying the Over Temp status until the Standby LED turns off, then release the Reset button to return the system to Run mode. Please see the “Troubleshooting” section for information on correcting the cause of an Over Temp fault condition.</p>
<ul style="list-style-type: none"> ● Run ● Ready ● Standby ● Stop 	<ul style="list-style-type: none"> ● Fault ● Over Load ● Over Temp ● Over Voltage 	<ul style="list-style-type: none"> ● Run ● Ready ● Standby ● Stop 	<ul style="list-style-type: none"> ● Fault ● Over Load ● Over Temp ● Over Voltage 	<p>Over Voltage status: This indicates that the AC mains voltage is more than +10% of nominal. All amplifiers in the system will be forced to Standby when an Over Voltage condition occurs. When the Over Voltage condition is cleared, the system will automatically return to Run mode.</p>	<p>To clear an Over Voltage fault condition, the AC mains must be brought down to the nominal value. If the system does not return to Run mode when the Over Voltage condition has cleared, one or more amplifiers may require servicing. Please see the “Troubleshooting” section for more information.</p>

6.3.5 Multi-Amp System Output Capabilities

Two 7224/7226s in Series – High-Voltage Mode

Ohms	PEAK OUTPUT						RMS OUTPUT					
	40 mSec Pulse, 20% Duty Cycle		5 Minutes, 100% Duty Cycle		1 Hour, 100% Duty Cycle		5 Minutes, 100% Duty Cycle		1 Hour, 100% Duty Cycle		Watts	
	Volts	Amps	Volts	Amps	Volts	Amps	Volts	Amps	Volts	Amps		
32	316	9.8	316	9.8	316	9.8	223	6.9	223	6.9	1539	
16	308	19	272	16.3	272	16.3	192	11.5	192	11.5	2208	
8	248	31	216	25.7	122	14.5	153	18.2	86	10.3	886	
4	196	49										

Two 7224/7226s in Series – Mid-Level Mode

Ohms	PEAK OUTPUT						RMS OUTPUT					
	40 mSec Pulse, 20% Duty Cycle		5 Minutes, 100% Duty Cycle		1 Hour, 100% Duty Cycle		5 Minutes, 100% Duty Cycle		1 Hour, 100% Duty Cycle		Watts	
	Volts	Amps	Volts	Amps	Volts	Amps	Volts	Amps	Volts	Amps		
8	144	18	138	16.4	138	16.4	98	11.6	98	11.6	1137	
4	122	30	114	26.2	114	26.2	81	18.5	81	18.5	1499	
2	94	47	86	39.6	42	21	61	28	30	14.8	444	
1	52	52										

Two 7224/7226s in Series – High-Current Mode

Ohms	PEAK OUTPUT						RMS OUTPUT					
	40 mSec Pulse, 20% Duty Cycle		5 Minutes, 100% Duty Cycle		1 Hour, 100% Duty Cycle		5 Minutes, 100% Duty Cycle		1 Hour, 100% Duty Cycle		Watts	
	Volts	Amps	Volts	Amps	Volts	Amps	Volts	Amps	Volts	Amps		
2	*	*	58	29	58	29	41	20.5	41	20.5	841	
1.5	*	*	52	34	52	34	37	24	37	24	888	
1	*	*	46	45	46	45	33	31.8	33	31.8	1049	

Three 7224/7226s in Series – High-Voltage Mode

Ohms	PEAK OUTPUT						RMS OUTPUT					
	40 mSec Pulse, 20% Duty Cycle		5 Minutes, 100% Duty Cycle		1 Hour, 100% Duty Cycle		5 Minutes, 100% Duty Cycle		1 Hour, 100% Duty Cycle		Watts	
	Volts	Amps	Volts	Amps	Volts	Amps	Volts	Amps	Volts	Amps		
48	474	9.8	474	9.8	474	9.8	335	6.9	335	6.9	2312	
24	462	16.3	408	16.3	408	16.3	288	11.5	288	11.5	3312	
12	372	31	324	25.7	183	14.5	229	18.2	129	10.3	1322	
6	294	49										

Three 7224/7226s in Series – Mid-Level Mode

Ohms	PEAK OUTPUT						RMS OUTPUT					
	40 mSec Pulse, 20% Duty Cycle		5 Minutes, 100% Duty Cycle		1 Hour, 100% Duty Cycle		5 Minutes, 100% Duty Cycle		1 Hour, 100% Duty Cycle		Watts	
	Volts	Amps	Volts	Amps	Volts	Amps	Volts	Amps	Volts	Amps		
12	216	18	207	16.4	207	16.4	146	11.6	146	11.6	1693	
6	183	30	171	26.2	171	26.2	121	18.5	121	18.5	2241	
3	141	47	129	39.6	63	21	91	28	44.5	14.8	661	
1.5	78	52										

Three 7224/7226s in Series – High-Current Mode

Ohms	PEAK OUTPUT						RMS OUTPUT				
	40 mSec Pulse, 20% Duty Cycle		5 Minutes, 100% Duty Cycle		1 Hour, 100% Duty Cycle		5 Minutes, 100% Duty Cycle		1 Hour, 100% Duty Cycle		
	Volts	Amps	Volts	Amps	Volts	Amps	Volts	Amps	Volts	Amps	Watts
3	*	*	87	29	87	29	61.5	20.5	61.5	20.5	1261
2.25	*	*	78	34	78	34	55	24	55	24	1322
1.5	*	*	69	45	69	45	49	31.8	49	31.8	1559

Two Paralleled 7224/7226s – High-Voltage Mode

Ohms	PEAK OUTPUT						RMS OUTPUT				
	40 mSec Pulse, 20% Duty Cycle		5 Minutes, 100% Duty Cycle		1 Hour, 100% Duty Cycle		5 Minutes, 100% Duty Cycle		1 Hour, 100% Duty Cycle		
	Volts	Amps	Volts	Amps	Volts	Amps	Volts	Amps	Volts	Amps	Watts
8	158	19.6	158	19.6	158	19.6	112	13.9	112	13.9	1557
4	154	38	136	32.6	136	32.6	96	23	96	23	2213
2	124	62	108	51.4	61	29	76	36.3	43	20.5	882
1	98	98									

Two Paralleled 7224/7226s – Mid-Level Mode

Ohms	PEAK OUTPUT						RMS OUTPUT				
	40 mSec Pulse, 20% Duty Cycle		5 Minutes, 100% Duty Cycle		1 Hour, 100% Duty Cycle		5 Minutes, 100% Duty Cycle		1 Hour, 100% Duty Cycle		
	Volts	Amps	Volts	Amps	Volts	Amps	Volts	Amps	Volts	Amps	Watts
2	144	18	69	32.8	69	32.8	49	23.2	49	23.2	1136
1	122	30	57	54.4	57	54.4	40	38.5	40	38.5	1538
0.5	94	47	43	79.2	21	42	30.4	14.9	14.8	29.7	439
0.25	52	52									

Two Paralleled 7224/7226s – High Current Mode

Ohms	PEAK OUTPUT						RMS OUTPUT				
	40 mSec Pulse, 20% Duty Cycle		5 Minutes, 100% Duty Cycle		1 Hour, 100% Duty Cycle		5 Minutes, 100% Duty Cycle		1 Hour, 100% Duty Cycle		
	Volts	Amps	Volts	Amps	Volts	Amps	Volts	Amps	Volts	Amps	Watts
0.5	*	*	29	58	29	58	20.5	41	20.5	41	841
0.375	*	*	26	68	26	68	18.4	48.1	18.4	48.1	885
0.25	*	*	22.7	90	22.7	90	16	63.6	16	63.6	1018

Three Paralleled 7224/7226s – High-Voltage Mode

Ohms	PEAK OUTPUT						RMS OUTPUT				
	40 mSec Pulse, 20% Duty Cycle		5 Minutes, 100% Duty Cycle		1 Hour, 100% Duty Cycle		5 Minutes, 100% Duty Cycle		1 Hour, 100% Duty Cycle		
	Volts	Amps	Volts	Amps	Volts	Amps	Volts	Amps	Volts	Amps	Watts
5.34	158	29.4	158	29.4	158	29.4	112	20.8	112	20.8	2328
2.67	1574	57	136	48.9	136	48.9	96	34.6	96	34.6	3319
1.34	124	93	108	77.1	61	43.5	76	54.5	43	30.8	1322
0.67	98	147									

Three Paralleled 7224/7226s – Mid-Level Mode

Ohms	PEAK OUTPUT						RMS OUTPUT				
	40 mSec Pulse, 20% Duty Cycle		5 Minutes, 100% Duty Cycle		1 Hour, 100% Duty Cycle		5 Minutes, 100% Duty Cycle		1 Hour, 100% Duty Cycle		
	Volts	Amps	Volts	Amps	Volts	Amps	Volts	Amps	Volts	Amps	Watts
1.34	144	54	69	49.2	69	49.2	49	34.8	49	34.8	1704
0.67	122	90	57	78.6	57	78.6	40	55.6	40	55.6	2223
0.34	94	141	43	118.8	21	63	30.4	84	14.8	44.5	659
0.167	52	156									

Three Paralleled 7224/7226s – High-Current Mode

Ohms	PEAK OUTPUT						RMS OUTPUT				
	40 mSec Pulse, 20% Duty Cycle		5 Minutes, 100% Duty Cycle		1 Hour, 100% Duty Cycle		5 Minutes, 100% Duty Cycle		1 Hour, 100% Duty Cycle		
	Volts	Amps	Volts	Amps	Volts	Amps	Volts	Amps	Volts	Amps	Watts
0.34	*	*	29	87	29	87	20.5	61.5	20.5	61.5	1261
0.25	*	*	26	102	26	102	18.4	72.1	18.4	72.1	1327
0.167	*	*	22.7	135	22.7	135	16	95.5	16	95.5	1527

Four Paralleled 7224/7226s – High-Voltage Mode

Ohms	PEAK OUTPUT						RMS OUTPUT				
	40 mSec Pulse, 20% Duty Cycle		5 Minutes, 100% Duty Cycle		1 Hour, 100% Duty Cycle		5 Minutes, 100% Duty Cycle		1 Hour, 100% Duty Cycle		
	Volts	Amps	Volts	Amps	Volts	Amps	Volts	Amps	Volts	Amps	Watts
4	158	39.2	158	39.2	158	39.2	112	27.7	112	27.7	3104
2	154	76	136	65.2	136	65.2	96	46.1	96	46.1	4425
1	124	124	108	102.8	61	58	76	72.7	43	41	1763
0.5	98	196									

Four Paralleled 7224/7226s – Mid-Level Mode

Ohms	PEAK OUTPUT						RMS OUTPUT				
	40 mSec Pulse, 20% Duty Cycle		5 Minutes, 100% Duty Cycle		1 Hour, 100% Duty Cycle		5 Minutes, 100% Duty Cycle		1 Hour, 100% Duty Cycle		
	Volts	Amps	Volts	Amps	Volts	Amps	Volts	Amps	Volts	Amps	Watts
1	144	72	69	65.6	69	65.6	49	46.4	49	46.4	2273
0.5	122	120	57	104.8	57	104.8	40.3	74.1	40.3	74.1	2986
0.25	94	188	43	158.4	21	84	30.4	112	14.8	59.4	879
0.125	52	208									

Four Paralleled 7224/7226s – High-Current Mode

Ohms	PEAK OUTPUT						RMS OUTPUT				
	40 mSec Pulse, 20% Duty Cycle		5 Minutes, 100% Duty Cycle		1 Hour, 100% Duty Cycle		5 Minutes, 100% Duty Cycle		1 Hour, 100% Duty Cycle		
	Volts	Amps	Volts	Amps	Volts	Amps	Volts	Amps	Volts	Amps	Watts
0.25	*	*	29	116	29	116	20.5	82	20.5	82	1681
0.1875	*	*	26	136	26	136	18.4	96.2	18.4	96.2	1769
0.125	*	*	22.7	180	22.7	180	16	127.3	16	127.3	2036

7 Amplifier Signal Flow

7.1 Input Signals

The input signal is routed from the SIM (Specialized Input Module) on the back panel to the Main board. From there, the signal is amplified through low-noise operational amplifier gain stages, compensation networks, and current limiting/ODEP and then final gain stage to the Output board. At the Output board, the signal is sent through pre-drivers, output stage drivers, then to the Output stage whose topology is a full-complimentary, full-bridge, AB+B mode transistor design. Amplifier control and status is handled by logic circuits tied to the Display/Control board on the front panel. Protection is provided by current limiting circuits and special junction temperature simulation circuits using thermal feedback from the main heat sinks on the Output board.

7.2 AC Mains Power

Power to the amplifier is connected through a 20-amp IEC-type inlet connector with an integral EMI filter network on the back panel. AC mains power is first routed through the front panel switch/breaker, then to the Power Supply board. From there, the AC mains are distributed to the main power transformers, and then from the transformers back through the Power Supply board to the Main board.

The Power Supply board allows for easy configuration of primary and secondary voltages. The Power Supply board also performs the “bi-level” function. This allows the power supply rails to the Output section to increase or decrease depending on demand and keeps the voltage dropped across the outputs to a minimum, thereby decreasing heat dissipation.

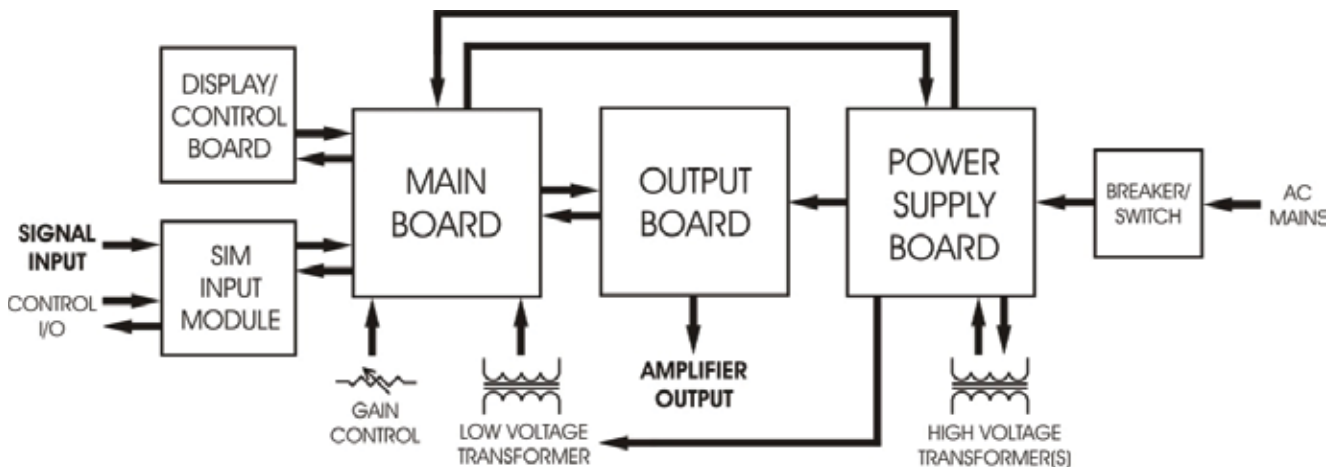
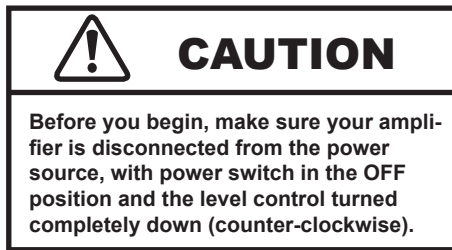

Figure 7.1 – Board-Level Functional Block Diagram

8 Maintenance

Simple maintenance can be performed by the user to help keep the equipment operational. The following routine maintenance is designed to prevent problems before they occur. See the “**Troubleshooting**” section, for recommendations for restoring the equipment to operation after an error condition has occurred.

Preventative maintenance is recommended after the first 250 hours of operation, and every three months or 250 hours thereafter. If the equipment environment is dirty or dusty, preventative maintenance should be performed more frequently.



8.1 Clean Amplifier Filter and Grills

8.1.1 Tools Required

The recommended equipment and supplies needed to perform the functions required for this task are described below.

- Vacuum cleaner
- Damp cloth (use water only or a mild soap diluted in water)

To ensure adequate cooling and maximum efficiency of the internal cooling fans, the amplifier's front and rear grills should be cleaned periodically. To clean the amplifier grills and filter, complete the following steps:

1. Turn completely down (counter-clockwise) all level controls and turn the amplifier OFF. Disconnect the amplifier from its power source.
2. Using a vacuum cleaner, vacuum the front ventilation grill, including the filter behind the grill, and the back ventilation exit grill.
3. Using a damp cloth, clean the front and rear ventilation grills. Dry with a clean cloth or allow to air dry. **IMPORTANT: Grills should be completely dry before plugging in or restarting amplifier.**

9 Troubleshooting

9.1 Introduction & Precautions

This section provides a set of procedures for identifying and correcting problems with the 7224/7226 amplifier. Rather than providing an exhaustive and detailed list of troubleshooting specifications, this section aims to provide a set of shortcuts intended to get an inoperative amplifier back in service as quickly as possible.

The procedures outlined in this section are directed toward an experienced electronic technician; it assumes that the technician has knowledge of typical electronic repair and test procedures.

Please be aware that the 7224 and 7226 amplifiers will undergo frequent engineering updates. As a result, modules and electronic assemblies may not be interchangeable between units. Particularly, the Main board undergoes periodic engineering modifications that may make interchangeability between units impossible.



DANGER

Uninsulated terminals with AC Mains potential are exposed when the panel is removed. Do not proceed until AC Mains have been disconnected.

9.2 Visual Inspection

Before attempting to troubleshoot the amplifier while it is operating, please take time to complete a visual inspection of the internal components of the amplifier.

1. To perform a Visual Inspection, first turn the Breaker/Switch to the Off (O) position.
2. Disconnect the AC mains plug from the amplifier.
3. Wait three to five minutes for the Power Supply capacitors to discharge. You can verify the capacitor discharge by connecting a voltmeter across +Vcc and –Vcc test points on the main board (see **Figure 9.1**). Verify a reading of less than 50 volts before proceeding.
4. Inspect the amplifier's internal components. Check the following:
 - Inspect modules for charring, breaks, deformation or other signs of physical damage.
 - Look for any foreign objects lodged inside the unit.
 - Inspect the entire lengths of wires and ribbon cables for breaks or other physical damage.

If there is any physical damage to the amplifier, please return it to AE Techron or an AE Techron Service Center for repair.

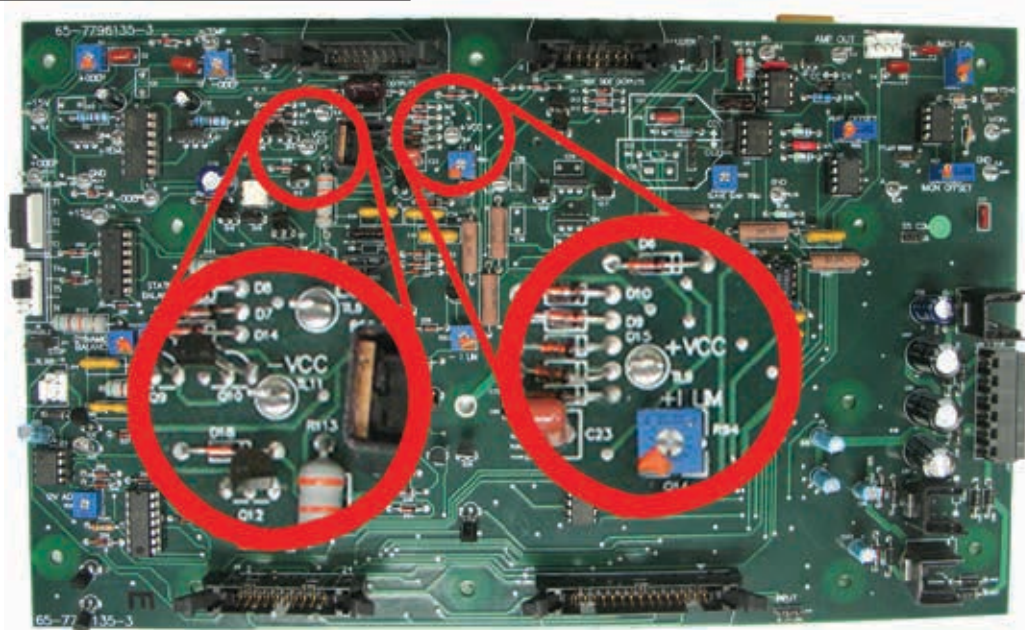

Figure 9.1 – +Vcc and –Vcc Point Locations

9.3 No Signal

Missing Output signal may be caused by one of the following:

1. Master/Slave Jumpers are set to the Slave (down) position. The amplifier should only be configured for Slave mode if it is in a multi-amplifier system; otherwise it should be set for Master mode. See the **“Advanced Configuration”** section in this manual for more information.
2. Signal is not connected to any inputs on the SIM card. See the **“Amplifier Setup”** section in this manual for more information.

9.4 No LEDs Illuminated or No Fans

If none of the LEDs on the Display Panel are illuminated and/or the fans are inoperative, check the following:

1. The AC mains are not connected or not on (see the **“Amplifier Setup”** section for more information).
2. Front Panel Breaker/Switch has been tripped. Reset by turning the unit Off (O) and then On.
3. Fuse F1 is open.

To Inspect Fuse F1 follow these steps:

1. Turn Off (O) the amplifier and disconnect the AC mains.
2. Remove Access Panel (see **“Advanced Configuration”**).
3. Locate Fuse F1 (see **Figure 9.2**). Remove fuse and inspect. Replace, if necessary, with same type fuse (T1.6A L 250V).

9.5 OverVoltage LED Lit

The amplifier will protect itself from AC mains voltage that is 10% above the voltage indicated on the back panel. If the AC mains voltage is more than 10% above the operating voltage, reduce the AC mains voltage to the proper level. When the line voltage condition is corrected, the amplifier will automatically reset. If the amplifier does not automatically reset, the amplifier's three internal transformers may need to be rewired. Please see the end of this section for Factory Service information.

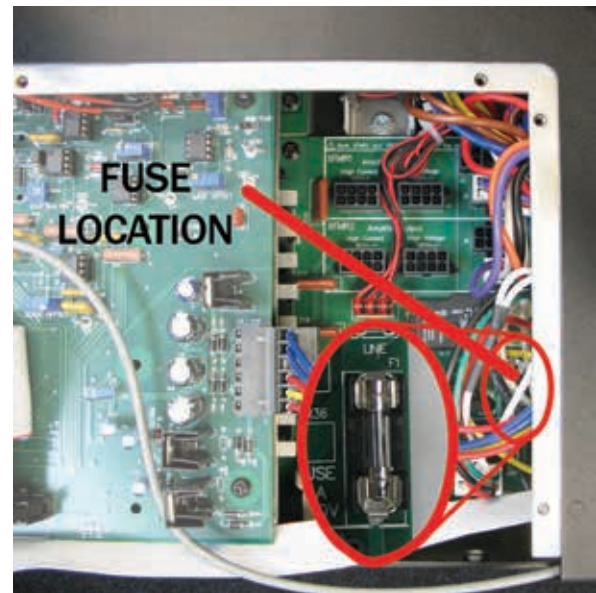

Figure 9.2 – Fuse F1 Location

9.6 Standby LED Remains Illuminated

The Standby indicator may remain illuminated under three conditions:

1. If the output wells or power transformer have overheated. If overheating is the problem, see the following topic (**“Amplifier Overheats”**).
2. If both the Standby and Ready LEDs remain illuminated and the Interlock I/O Cable is being used, the amplifier is being held in Remote Standby mode by another device (see **Figure 9.3**). For more information on 7224/7226 Remote Operation, see the **“Applications”** section in this manual.
3. If the connection to the Interlock – I/O Connector or other input/output connection isn't fully secure. Check all wiring and connections.



Figure 9.3 – Interlock I/O Connector

9.7 Amplifier Overheats (Over Temp Fault Condition)

There are two possible reasons why the amplifier is overheating:

1. Excessive Power Requirements
2. Inadequate Airflow

9.7.1 Excessive Power Requirements

An amplifier will overheat if the required power exceeds the amplifier's capabilities. High duty cycles and low-impedance loads are especially prone to cause overheating. To see if excess power requirements are causing overheating, check the following:

1. The application's power requirements fall within the specifications of the amplifier. See the "**Specifications**" section.
2. Faulty output connections and load.
3. Undesired DC offset at the Output and Input signal.

If the amplifier chronically overheats with suitable power/load conditions, then the amplifier may not be receiving adequate airflow. To check for adequate airflow, proceed with the following step:

9.7.2 Check for Inadequate Airflow

1. Check air filters. Over time they can become dirty and worn out. It is a good idea to clean the air filters periodically with a mild detergent and water.
2. Visually inspect fans to assure correct operation while amplifier is On (I).

Any inoperative, visibly slow, or reverse-spinning fan should be replaced. Please see the Factory Service information at the end of this section.

An OverTemp condition places the amplifier in Standby mode. If the OverTemp pulse is extremely short, as in the case of defective wiring or switches, the OverTemp pulse may be too brief to observe.

9.7.3 Resetting After OverTemp

When the amplifier has cooled enough to eliminate the OverTemp condition, it should automatically return to Run mode. If the amplifier fails to return to Run mode, make sure fans are running, then remove the input signal from the amplifier. Allow the fans to run for five minutes, and then push the Reset button to reset the amplifier. If the amplifier does not reset, it may require servicing. Please contact AE Techron Technical Support.

9.8 Fault LED is Illuminated

The 7224/7226 amplifiers contain protection circuitry that disables the amplifier if an output stage is behaving abnormally. This usually indicates an output transistor has shorted.

To clear the Fault condition, follow these steps:

1. Turn off the signal source.
2. Turn off the AC mains.
3. Turn AC mains power back on. If the Fault LED doesn't illuminate again, turn the signal source on.

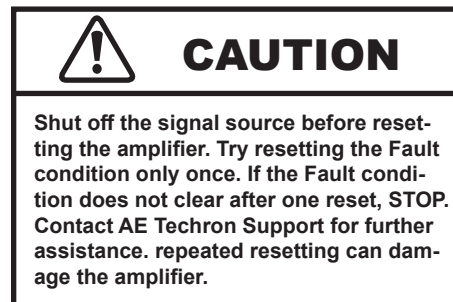

4. If the Fault LED is still illuminated and the Fault condition doesn't clear, return the amplifier for Factory Service. Please see the Factory Service information at the end of this section.

9.9 Factory Service

If the troubleshooting procedures are unsuccessful, the amplifier may need to be returned for Factory Service. All units under warranty will be serviced free of charge (customer is responsible for one-way shipping charges as well as any cus-

tom fees, duties, and/or taxes). Please review the Warranty at the beginning of this manual for more information.

All service units must be given Return Authorization by AE Techron, Inc. before being returned. Return Authorizations can be requested on our website or by contacting our Customer Service Department.

Please take extra care when packaging your amplifier for repair. It should be returned in its original

packaging or a suitable alternative. Replacement packaging materials can be purchased for a nominal fee.

Please send all service units to the following address and be sure to include your Return Authorization Number on the box.

AE Techron, Inc.
Attn: Service Department / RMA#
2507 Warren Street
Elkhart, IN 46516

10 Specifications

Performance

Testing was done at 100 Hz. Continuous DC power levels are lower. See DC Specifications chart.

Small Signal Frequency Response:

DC - 300 kHz, +0.0 to -1.0 dB

Slew Rate:

7224: 75 V/ μ Sec

7226: 100 V/ μ Sec

Residual Noise:

10 Hz to 300 kHz: 950 μ V (0.95 mV)

10 Hz to 80 kHz: 300 μ V (0.3 mV)

Signal-to-Noise Ratio:

10 Hz - 30 kHz: -113 dB

10 Hz - 80 kHz: -106.6 dB

10 Hz - 300 kHz: -99.9 dB

Unit to Unit Phase Error:

\pm 0.1 degrees at 60 Hz

THD:

DC - 30 kHz, less than 0.1%

Output Offset:

7224: $<\pm$ 5 mV

7226: $<\pm$ 400 μ V

DC Drift:

7224: $<\pm$ 1.5 mV

7226: $<\pm$ 200 μ V (after 20 minutes of operation)

Output Impedance:

5.3 mOhm in Series with 0.95 μ H

Phase Response:

\pm 5 degrees (10 Hz - 10 kHz) plus 560 nsec propagation delay

Input Characteristics

Balanced with ground:

Three terminal barrier block connector, 20k ohm differential

Unbalanced:

BNC connector, 10k ohm single ended. Fixed or variable gain

Gain:

Voltage Mode: 20 volts/volt

Current Mode: 5 amperes/volt

Gain Linearity (over input signal, from 0.2V to 5V):

7224: 0.15%

7226: 0.02% (DC); 0.05% (AC)

Max Input Voltage:

\pm 10 V balanced or unbalanced

Input Impedance:

20 kOhm differential

Common Mode Rejection:

-58 dB with 5V input

Display, Control, Status, I/O

Front Panel LED Displays indicate:

Ready, Standby, Fault, Over Temp, Over Voltage, Overload

Soft Touch Switches for:

Run, Stop, Reset

Gain Control, when enabled:

Voltage gain adjustable from 20 to 0

On/Off Breaker

Back Panel Power Connection:

25 Amp IEC (with retention latch)

Signal Output:

Three-position terminal strip (OUTPUT/COM/CHASSIS GROUND); resistor between COM and CHASSIS GROUND terminals is a 2.7-ohm, 2W, 5%, metal-oxide resistor

Signal Input:

User Selectable BNC or Barrier Strip Balanced

Communication Capabilities

Current Monitor:

\pm 1 V / 5 A \pm 1%

Reporting:

System Fault, Over Temp, Over Voltage, Over Load

Control:

Force to Standby, Reset after a fault

Physical Characteristics

Chassis:

The Amplifier is designed for stand-alone or rack-mounted operation. The Chassis is black aluminum with a powder coat finish. The unit occupies two EIA 19-inch-wide units.

Weight:

41 lbs (18.6 kg), Shipping 51 lbs (23.2 kg)

AC Power:

Single phase, 120 VAC, 60 Hz, 20 Amp service; (220-240 VAC, 50-60 Hz, 10 Amp service model available)

Operating Temperature:

10°C to 50°C (50°F to 122°F), maximum output Power de-rated above 30°C (86°F).

Humidity:

70% or less, non-condensing

Cooling:

Forced air cooling from front to back through removable filters.

Airflow:

180CFM

Dimensions:

19" x 22.75" x 3.5" (48.3 cm x 57.8 cm x 8.9 cm)

Protection

Over/Under Voltage:

± 10% from specified supply voltage amplifier is forced to Standby

Over Current:

Breaker protection on both main power and low voltage supplies

Over Temperature:

Separate Output transistor, heat sink, and transformer temperature monitoring and protection

DC Specifications – High-Current Mode

	5 Minutes	1 Hour
Volts DC	Amps DC	
24.0	26	20
13.5	20	16
3.0*	25	25

* A 120VAC-only special configuration.

AC Specifications – High-Voltage Mode

Ohms	PEAK OUTPUT						RMS OUTPUT					
	40 mSec Pulse, 20% Duty Cycle		5 Minutes, 100% Duty Cycle		1 Hour, 100% Duty Cycle		5 Minutes, 100% Duty Cycle		1 Hour, 100% Duty Cycle			
	Volts	Amps	Volts	Amps	Volts	Amps	Volts	Amps	Volts	Amps	Watts	
16	158	9.8	158	9.8	158	9.8	112	6.9	112	6.9	773	
8	154	19	136	16	136	16	96	11.5	96	11.5	1104	
4	124	31	108	25.7	61	14.5	76	18.2	43	10.3	443	
2	98	49										

AC Specifications – Mid-Level Mode

Ohms	PEAK OUTPUT						RMS OUTPUT					
	40 mSec Pulse, 20% Duty Cycle		5 Minutes, 100% Duty Cycle		1 Hour, 100% Duty Cycle		5 Minutes, 100% Duty Cycle		1 Hour, 100% Duty Cycle			
	Volts	Amps	Volts	Amps	Volts	Amps	Volts	Amps	Volts	Amps	Watts	
4	72	18	69	16.4	69	16.4	49	12	49	11.6	568	
2	61	30	57	26.2	57	26.2	40	19	40	18.5	740	
1	47	47	43	39.6	21	21	30	28	15	14.8	222	
0.5	26	52										

AC Specifications – High-Current Mode

Ohms	PEAK OUTPUT						RMS OUTPUT					
	40 mSec Pulse, 20% Duty Cycle		5 Minutes, 100% Duty Cycle		1 Hour, 100% Duty Cycle		5 Minutes, 100% Duty Cycle		1 Hour, 100% Duty Cycle			
	Volts	Amps	Volts	Amps	Volts	Amps	Volts	Amps	Volts	Amps	Watts	
1			29	29	29	29	21	21	20.5	20.5	420	
0.75			26	34	26	34	18	24	18	24	432	
0.5			22.7	45	22.7	45	16	32	16	32	512	

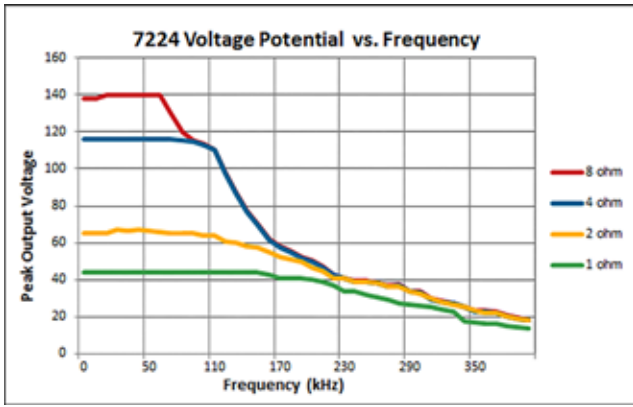

Figure 10.1 – 7224 Voltage Potential vs. Frequency

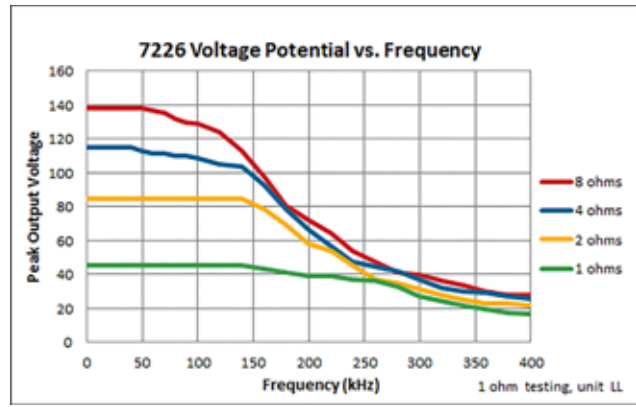

Figure 10.2 – 7226 Voltage Potential vs. Frequency

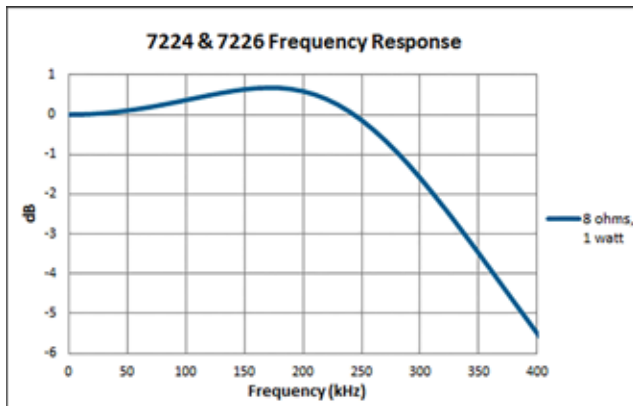

Figure 10.3 – 7224 & 7226 Frequency Response

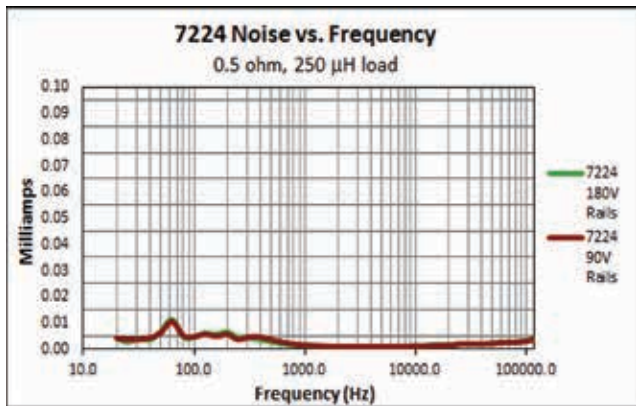

Figure 10.4 – 7224 Noise vs. Frequency

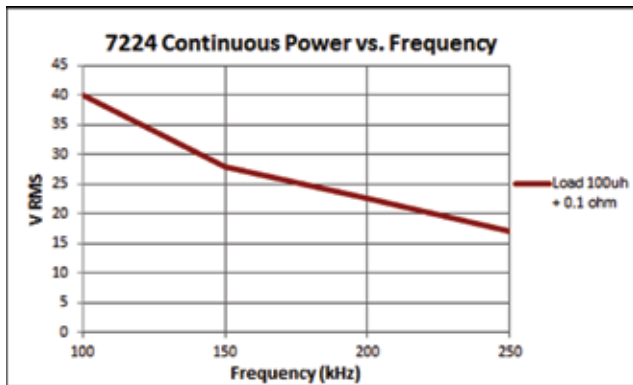

Figure 10.5 – 7224 Continuous Power vs. Frequency

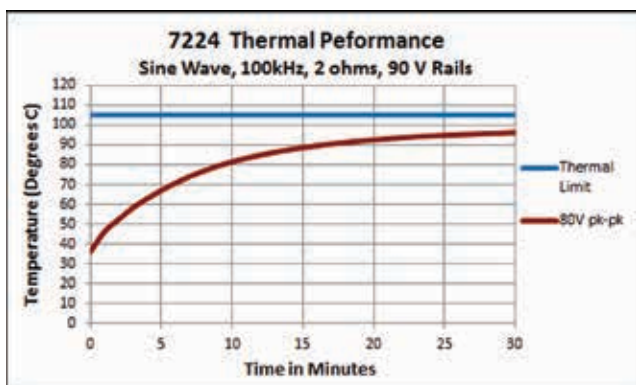

Figure 10.6 – 7224 Thermal Performance

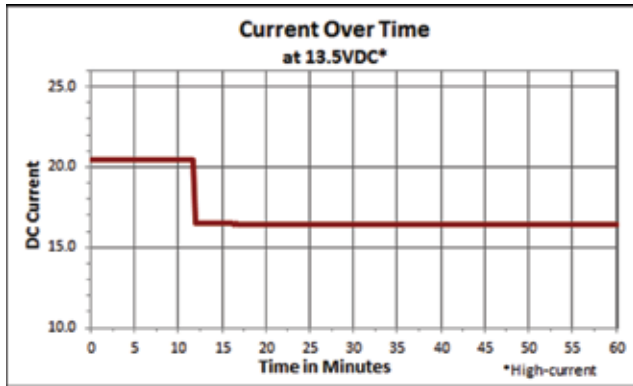

Figure 10.7 – 7224 DC Current Over Time at 13.5 VDC

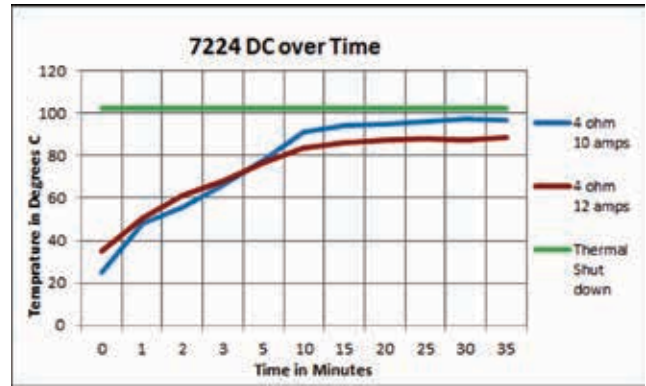

Figure 10.8 – 7224 DC Current Over Time Comparison with 4-ohm Load

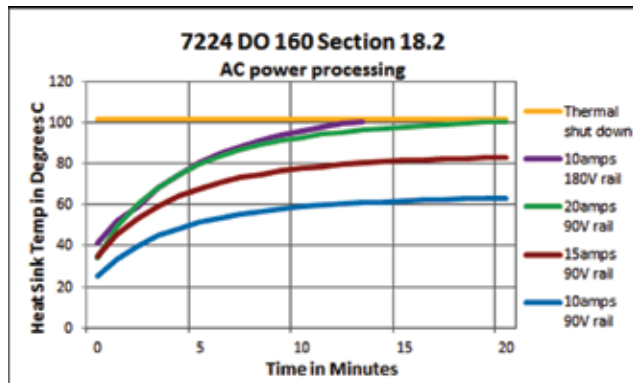

Figure 10.9 – 7224 DO 160 Section 18.2 AC Power Processing

Appendix A: SIM - Interlock I/O Connector Pinouts and Functions

Pin #	Function	Description	Signal Type	Level when Asserted	Level when Deasserted	Notes	Applications
1	Amplifier Output	Used for driving slave amplifiers; monitoring amplifier output voltage	AC or DC	Can be greater than $\pm 200V$ peak	0V	Used for monitoring amplifier output voltage; driving slave amplifiers in multi-amp systems. Wired to amplifier output. Do not connect to any impedance of less than 10K ohm.	Voltage Monitoring: Connect a voltage meter to monitor the output voltage being produced by the amplifier. Connect across PIN 1 (Amp Out) and PIN 10 (Sampled Common).
2	Sampled Common	Load connected here for Current sense	AC or DC	Up to $\pm 2V$ peak relative to Common	0V	Used for driving slave amplifiers in multi-amp systems, controlled voltage or controlled current mode.	Driving Slave Amplifiers: Amplifier External Reference, 2V peak maximum from PIN 14 (Common).
3	+1 IN	Differential Slave input	AC or DC	Can be greater than $\pm 200V$ peak	0V	Only used in multiple amplifier configurations - Series mode.	Can accept output of PIN 1 (Amplifier Output) OR PIN 2 (Sampled Common) from Master device when in Slave mode.
4	Interlock	Amplifier Interlock input	DC	0V to 8V	10V to 15V	When "low", forces to Standby; when allowed to float, allows Run (if amplifier is "Ready"). IMPORTANT: amplifiers must be configured for Run mode at startup (factory default) or the Run button must be pressed at the amplifier front panel at startup.	Remote to Standby: Short PIN 4 of amplifier to Digital Ground (PIN 17) using dry contact switch or optocoupler. When closed, places amplifier in Standby. Multi-amplifier Systems, Simultaneous Enable or Disable of amplifiers: Daisy-chain Interlock (PIN4) across amps (if sharing the same Sampled Common power connections). Optocoupler must be used for multi-amps in series.
5	Amp Ready	Ready output of amplifier	DC	0V	-14V	Normally reserved for OPTOC use; not recommended for normal customer use. Line has series resistor and unloaded will go from 0V (not ready) to -15V (ready), with an OPTOC BNC card the signal will go from 0V (not ready) to -1.2Vdc (ready)	Not recommended for normal customer use.
6	I MON +	Differential Current Monitor +	AC or DC	7212/7224/7226: 5A/V 7548/7794/7796/7796HC: 20A/V		Output current produced per voltage detect.	Current Monitoring: Connect a voltage meter to monitor the output current being produced by the amplifier. For unbalanced, for each 1V detected, current output is 5A (7212/7224/7226) or 20A (7548/7794/7796/7796HC).
7	None	No connection					Not currently used.
8	None	No connection					Not currently used.
9	Blanking input	Blanking control	DC	0 - 1Vdc allows normal operation	3.5 - 5Vdc output is muted	Used in amplifiers with blanking feature included for blanking control.	Blanking Control: Use an external isolated 5V power supply to mute the output of the amplifier.

Pin #	Function	Description	Signal Type	Level when Asserted	Level when Deasserted	Notes	Applications
10	Sampled Common	Amp Analog Ground; Blanking Ground				Amplifier ground.	Can be used as Blanking return or as a reference of the amplifier for status reporting applications. See OverTemp (PIN 11), Run (PIN 12), Overload (PIN 23), and OverVoltage (PIN 24).
11	OverTemp Out	Over-temperature output	DC	-24V	0V	When amp is normal, this pin is pulled to -24V through a 47.5K-ohm resistor; when amp is in OverTemp state, this pin is grounded. Do not exceed 7 milliamps.	Remote Signal of Over-Temperature Condition: LED, when lit, signals Over Temperature condition. Use a 6 mA series resistor of 4.7K-ohm for LED or OPTO, tie to -24V source (PIN 13).
12	Run	Amplifier Run output	DC	-24V	0V	When amp is in Standby mode, this pin is pulled to -24V; when amp is in Run mode, this pin is grounded, energizing Mains Relays and allowing drive for an external LED. DO NOT exceed 7mA; DO NOT ground this pin as this will enable Main Power Relays.	Remote Signal of Run Condition: LED, when lit, signals Run state. Use a 6mA series resistor of 4.7K-ohm for LED or OPTO, tie to -24V source (PIN 13).
13	-24V	-24V Power Output	DC			-24V dc, 30 mA max	Internally tied for use in status reporting applications. See OverTemp (PIN 11), Run (PIN 12), Overload (PIN 23), and OverVoltage (PIN 24).
14	Common	Ground before Sense Resistors				Current monitor reference. Voltage between Common and Sampled Common is voltage on the Current Sense resistor.	Possibly series amplifiers will not need current reporting on the High side amp, since its current will be same as Master.
15	-1 IN	Differential Slave Input	AC or DC	Up to 200V peak	0V	Only used in multiple amplifier configurations, Series mode.	Can accept output of PIN 1 (Amplifier Output) OR PIN 2 (Sampled Common) from Master device when in Slave mode.
16	+24V	+24V Power Output	DC			+24V dc, 30 mA max.	Used in status reporting applications. See OverTemp (PIN 11), Run (PIN 12), Overload (PIN 23), and OverVoltage (PIN 24).
17	Digital Ground	Digital circuitry ground - Interlock Common	DC	0V	0V		Used with PIN 25 (Reset) for Remote Reset from Standby or Stop after Error. Used with PIN 4 (Interlock) for simultaneous remote to Standby of all amps in a multi-amplifier system.
18	OEM App	Input Monitor (OEM only)				Used to monitor the input signal from an OEM DAC card; this is the actual input signal.	OEM modification only; normally no connection.
19	I MON – (alt.: OEM App)	Differential Current Monitor – ; (- Input Monitor, OEM only)	AC or DC	7212/7224/7226: 5A/V 7548/7794/7796/7796HC: 20A/V		Inverted I MON+ (PIN 6). Output current produced per voltage detect.	Current Monitoring: Connect a voltage meter to monitor the output current being produced by the amplifier. For each 1V detected, current output is 5A (7212/7224/7226) or 20A (7548/7794/7796/7796HC).

Pin #	Function	Description	Signal Type	Level when Asserted	Level when Deasserted	Notes	Applications
20	I SUM1-	Multiple Amplifier Summing, Amplifier 1	DC			Planned for use in multiple amplifier configurations - paralleled and running Controlled Current Mode	Currently not used.
21	I SUM2-	Multiple Amplifier Summing, Amplifier 2	DC			Planned for use in multiple amplifier configurations - paralleled and running Controlled Current Mode	Currently not used.
22	I SUM3-	Multiple Amplifier Summing, Amplifier 3	DC			Planned for use in multiple amplifier configurations - paralleled and running Controlled Current Mode	Currently not used.
23	OverLoad Out	Overload output (amplifier output is clipping).	DC	-24V	0V	When amp is normal, this pin is pulled to -24V through a 47.5K-ohm resistor; when amp is in Overload state, this pin is grounded. Do not exceed 6 milliamps.	Remote Signal of Overload Condition: LED, when lit, signals Overload condition. Use a 6mA series resistor of 4.7K-ohm for LED or OPTO, tie to -24V source (PIN 13).
24	OverVoltage Out	Overvoltage output (High AC line voltage).	DC	-24V	0V	When amp is normal, this pin is pulled to -24V through a 47.5K-ohm resistor; when amp is in Overvoltage state, this pin is grounded. Do not exceed 6 milliamps.	Remote Signal of Overvoltage Condition: LED, when lit, signals Overvoltage condition. Use a 6mA series resistor of 4.7K-ohm for LED or OPTO, tie to -24V source (PIN 13).
25	Reset	Reset	DC	-15V	0V	Tie to PIN 13 (-24V dc) and create a -15V dc source; <2mA required for reset. Connect the -15V dc source to PIN 25 (Reset) through a 1K buffer resistor to reset.	Reset from Standby: Use a dry contact switch and voltage regulator to return amp to Ready/Run condition after Overload conditions. Assert -15V for at least 100 ms to clear error condition.
Gray shaded areas indicate pin not used / feature not implemented.						Blue shaded areas indicate used only in multi-amplifier systems.	