

# AETECHRON



## 7228 Operator's Manual

*Single-Channel Industrial Amplifier for Demanding, High-Power Systems*

# Limited One-Year Warranty

## SUMMARY OF WARRANTY

**AE TECHRON INC.** of Elkhart, Indiana (Warrantor) warrants to you, the ORIGINAL COMMERCIAL PURCHASER ONLY of each NEW **AE TECHRON INC.** product, for a period of one (1) year from the date of purchase, by the original purchaser (warranty period) that the product is free of defects in materials or workmanship and will meet or exceed all advertised specifications for such a product. This warranty does not extend to any subsequent purchaser or user, and automatically terminates upon your sale or other disposition of our product.

## ITEMS EXCLUDED FROM WARRANTY

We are not responsible for product failure caused by misuse, accident or neglect. This warranty does not extend to any product on which the serial number has been defaced, altered, or removed. It does not cover damage to loads or any other products or accessories resulting from AE TECHRON INC. product failure. It does not cover defects or damage caused by the use of unauthorized modifications, accessories, parts, or service.

## WHAT WE WILL DO

We will remedy, at our sole discretion, any defect in materials or workmanship by repair, replacement, or refund. If a refund is elected, you must make the defective or malfunctioning component available to us free and clear of all liens or other encumbrances. The refund will be equal to the actual purchase price, not including interest, insurance, closing costs, and other finance charges less a reasonable depreciation on the product from the date of original purchase. Warranty work can only be performed at our authorized service centers or at our factory. Expenses in remedying the defect will be borne by **AE TECHRON INC.**, including one-way surface freight shipping costs within the United States. (Purchaser must bear the expense of shipping the product between any foreign country and the port of entry in the United States and all taxes, duties, and other customs fees for such foreign shipments.)

## HOW TO OBTAIN WARRANTY SERVICE

When you notify us of your need for warranty service,

we will give you an authorization to return the product for service. All components must be shipped in a factory pack or equivalent which, if needed, may be obtained from us for a nominal charge. We will take corrective actions within a reasonable time of the date of receipt of the defective product. If the repairs made by us are not satisfactory, notify us immediately.

## DISCLAIMER OF CONSEQUENTIAL AND INCIDENTAL DAMAGES

You are not entitled to recover from us any consequential or incidental damages resulting from any defect in our product. This includes any damage to another product or products resulting from such a defect.

## WARRANTY ALTERATIONS

No person has the authority to enlarge, amend, or modify this warranty. The warranty is not extended by the length of time for which you are deprived of the use of this product. Repairs and replacement parts provided under the terms of this warranty shall carry only the unexpired portion of this warranty.

## DESIGN CHANGES

We reserve the right to change the design of any product from time to time without notice and with no obligation to make corresponding changes in products previously manufactured.

## LEGAL REMEDIES OF PURCHASER

There is no warranty that extends beyond the terms hereof. This written warranty is given in lieu of any oral or implied warranties not contained herein. We disclaim all implied warranties, including, without limitation, any warranties of merchantability or fitness for a particular purpose. No action to enforce this Warranty shall be commenced later than ninety (90) days after expiration of the warranty period.

### **AE Techron, Inc.**

Customer Service Department  
2507 Warren Street  
Elkhart, IN 46516  
U.S.A.  
574.295.9495  
[www.aetechron.com](http://www.aetechron.com)

## DECLARATION OF CONFORMITY

Technical Construction File Route

**Issued By:** AE Techron, Inc.  
2507 Warren Street  
Elkhart, IN 46516

**For Compliance Questions Only:** Larry Shank  
574-295-9495  
lshank@aetechron.com

**This Declaration of Conformity is issued under the sole responsibility of AE Techron, Inc., and belongs to the following product:**

**Equipment Type:** Industrial Power Amplifiers

**Model Name:** 7228

**EMC Standards:**

- EN 61326-1: 2013 – Electrical Equipment for Measurement, Control and Laboratory use  
— EMC Requirements
- EN 55011: 2009 + A1: 2010 – Industrial, Scientific and Medical (ISM) radio-frequency equipment  
— Radio disturbance characteristics  
— Limits and methods of measurement
- EN 61000-4-2: 2009 – Electromagnetic compatibility (EMC) Part 4: Testing and measurement techniques:  
Electrostatic discharge immunity test
- EN 61000-4-3: 2006 + A2: 2010 – Electromagnetic compatibility (EMC) Part 4: Testing and measurement techniques:  
Radiated radio-frequency electromagnetic field immunity test
- EN 61000-4-4: 2012 – Electromagnetic compatibility (EMC) Part 4: Testing and measurement techniques:  
Electrical fast transient/burst immunity test
- EN 61000-4-5: 2006 – Electromagnetic compatibility (EMC) Part 4: Testing and measurement techniques:  
Surge immunity test
- EN 61000-4-6: 2009 – Electromagnetic compatibility (EMC) Part 4: Testing and measurement techniques:  
Immunity to conducted disturbances induced by radio frequency field
- EN 61000-4-8: 2010 – Electromagnetic compatibility (EMC) Part 4: Testing and measurement techniques:  
Power frequency magnetic field immunity test
- EN 61000-4-11: 2004 – Electromagnetic compatibility (EMC) Part 4: Testing and measurement techniques:  
Voltage dips, short interruptions and voltage variations immunity test

**Safety Standard:**

BSEN61010-1:2010 (inc Corr. May 2011) – Safety requirements for electrical equipment for measurement, control, and laboratory use

I certify that the product identified above conforms to the requirements of the EMC Council Directive 2014/30/E, and the Low Voltage Directive 2014/35/EU.

**Signed:**



Larry Shank  
President

Place of Issue: Elkhart, IN, USA  
Date of Issue: August 16, 2017

CE Affixing Date: August 7, 2017

# Contents

1	Introduction .....	5
1.1	Features .....	5
1.2	Configuration Options.....	5
2	Amplifier Unpacking and Installation .....	6
2.1	Safety First .....	6
2.2	Unpacking .....	6
2.3	Installation .....	6
3	Connections and Startup .....	7
3.1	Other Operation Modes and Configurations.....	7
3.2	Connecting the Load .....	7
3.3	Connecting the Input Signal .....	8
3.4	Other DIP Switch Settings.....	9
3.5	Using the Expansion Port.....	9
3.6	Connecting the AC Supply .....	9
3.7	Start-up Procedure.....	9
4	Amplifier Operation .....	10
4.1	Front-Panel Controls .....	10
4.2	Front-Panel Indicators .....	12
4.3	Back-Panel Controls and Connectors .....	14
5	Advanced Configuration.....	15
5.1	DIP Switch Configurations.....	15
5.2	Internal Jumpers and Settings.....	18
6	Applications.....	22
6.1	Power Supply Settings for Increased Voltage or Current.....	22
6.2	Multi-amp Systems for Increased Voltage or Current.....	23
6.3	DB-62 Expansion Port Applications.....	31
6.4	Controlled Current Operation .....	38
6.5	DC Servo.....	41
6.6	Current Limiting.....	43
7	Maintenance .....	44
7.1	Clean Amplifier Filter and Grills.....	44
8	Troubleshooting .....	45
8.1	Introduction & Precautions .....	45
8.2	Visual Inspection .....	45
8.3	No Signal.....	45
8.4	No LEDs Illuminated.....	45
8.5	OverVoltage LED Lit.....	45
8.6	Standby and Stop LEDs Remain Illuminated .....	46
8.7	Standby LED Remains Illuminated.....	46
8.8	Amplifier Overheats (Over Temp Fault Condition).....	46
8.9	Fault LED is Illuminated .....	47
8.10	Factory Service .....	47
9	Specifications.....	48





Figure 1.1 – 7228 Front Panel

# 1 Introduction

Congratulations on your purchase of the 7228 power amplifier. The 7228 was developed to bring performance improvements and an extended feature set when compared to AE Techron’s industry standard 7224 amplifier. The 7228 amplifiers are built and tested to the most stringent quality standards for long life and outstanding performance. The AE Techron brand is known throughout the world for its robust precision amplifiers as well as its product service and support.

## 1.1 Features

The 7228 is a single-channel linear amplifier designed for use in demanding applications requiring very low noise, low distortion, and accurate power amplification from DC to 1 MHz. It features:

- Output of over 1,000 watts RMS at 8 ohms continuously for 45 minutes.
- 40 mSec pulses of up to 60 amperes peak into a 0.5 ohm load.
- Fast configuration in the field using back-panel DIP switches; includes user-variable current limit, DC blocking, DC Servo, multiamp, and more.
- Offers precision control of output offset, DC drift and gain linearity.
- Variable-speed fans minimize noise while optimizing output.
- Protection circuitry protects the AE Techron 7228 from input overloads, improper output connection (including shorted and improper loads), over-temperature, over-current, and supply voltages that are too high or low.

Performance Overview	
Small Signal Bandwidth	DC - 1 MHz
Max Continuous Power, 20 kHz	1000 watts
Max Continuous Power, 150 kHz	400 watts
Current Limit	60A
Slew Rate	100V/μs
DC Drift	200 μV*

\*With DC Servo enabled.

- Ground loop and circulating current protection includes a protection circuit that temporarily forces the amplifier to Standby.

## 1.2 Configuration Options

The 7228 can be easily configured in the field using back-panel DIP switches or remote contact closure. Configuration options include:

- DC Block enable/disable
- User-variable current limit
- DC Servo enable/disable
- Switch between supply rail modes and voltages to optimize for various load impedances
- Change from controlled-voltage to controlled-current operation
- Parallel operation
- Series operation

## 2 Amplifier Unpacking and Installation

The 7228 amplifier is a precision instrument that can be dangerous if not handled properly. Lethal voltages are present in both the AC input supply and the output of the amplifier. For this reason, safety should be your primary concern when you setup and operate this amplifier.

### 2.1 Safety First

Throughout this manual special emphasis is placed on good safety practices. The following graphics are used to highlight certain topics that require extra precaution.

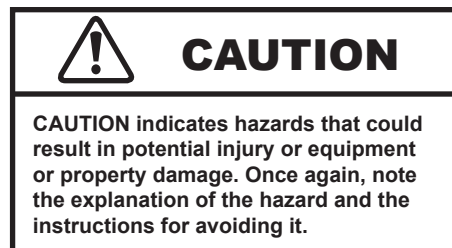
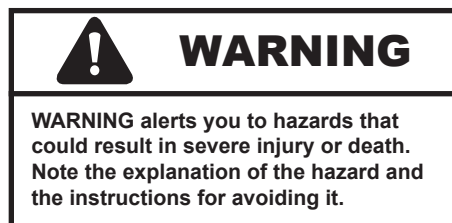
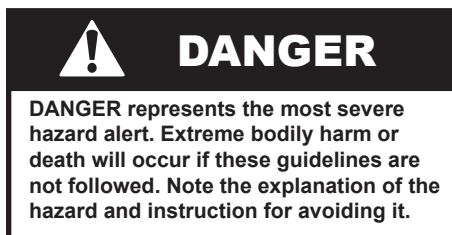

### 2.2 Unpacking

All amplifiers are tested and inspected for damage before leaving the factory. Carefully unpack and inspect the amplifier for damage. **Please note any damage for future reference and notify the shipping company immediately if damage is found.** Also, please save the shipping carton and materials as evidence of damage and/or for returning the amplifier for repair.

Along with any additional accessories purchased by the customer, all 7228 amplifiers ship with the following:

- 7228 Amplifier
- Toolkit (contains one #2 Phillips screwdriver and four rubber feet)
- Power Cord
- 7228 Operator's Manual and Quick Start sheet

### 2.3 Installation

The 7228 amplifiers are packaged in a rugged powder-coated aluminum chassis. This chassis is 2U (rack units) tall, and has rack "ears" on each side of the front panel for mounting to a standard EIA (Electronic Industries Association) rack. Use standard rack mounting hardware to mount the amplifier. Use nylon washers if you wish to protect the powder-coat finish on the front of the amplifier.

Optionally, the amplifier can be placed on a bench top; please keep in mind that the protective powder-coating can be scratched when placed on other equipment or on a bench top, especially when there is dirt present. To protect the finish, a set of rubber feet is included in the toolkit that can be installed on the bottom of the amplifier.

Allow ample space on the sides and especially the back of the amplifier for heated air to escape. The amplifier should be mounted in a rack that is adequately ventilated and not sealed. Likewise, the front of the amplifier should be unobstructed to allow cool air to enter the amplifier.

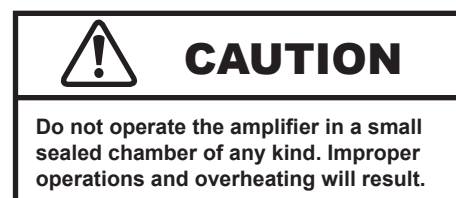

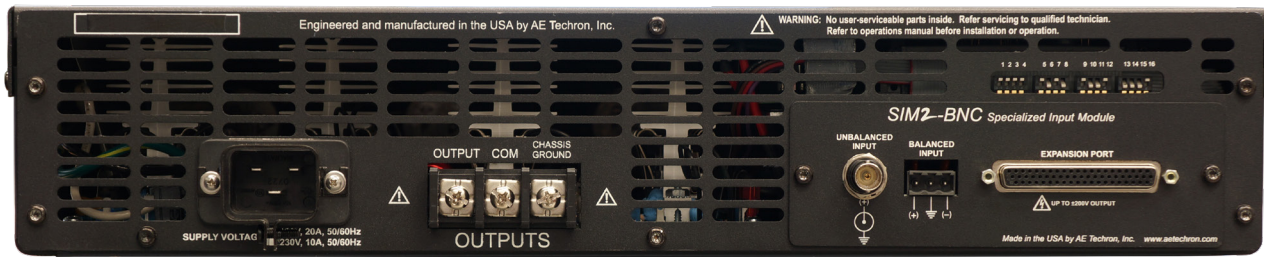
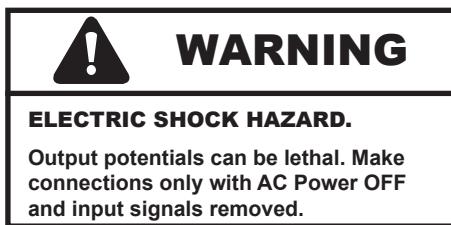

Figure 3.1 – 7228 Back Panel

### 3 Connections and Startup

This section details the wiring and startup procedures for a single 7228 amplifier operating in Controlled-Voltage mode (factory default). Before connecting the amplifier, make sure the AC power cord is unplugged.



#### 3.1 Other Operation Modes and Configurations

The 7228 amplifier can be field-configured for operation in a number of ways. The amplifier can be operated in Controlled-Voltage or Controlled-Current mode. It also can be configured for operation as a part of a multi-amplifier system. These alternate configurations may require special output wiring and/or additional components.

##### 3.1.1 Controlled-Current Operation of a Stand-Alone Amplifier

**IMPORTANT:** If your application requires Controlled Current operation, the 7228 amplifier first should be wired and tested in Controlled-Voltage mode to verify that the amplifier and input signal are operating correctly. Once proper operation is confirmed, refer to the *Applications* section of this manual for instructions on configuring and operating your amplifier in Controlled-Current mode.

##### 3.1.2 Multi-Amp Operation

If your application requires multi-amp operation for increased voltage or current, each amplifier should

first be wired and tested individually in Controlled-Voltage mode to ensure proper operation.

For **Series operation in Controlled-Voltage mode**, refer to the topic “Multiamp Systems for Increased Current or Voltage” in the *Applications* section of this manual for information on Series system configuration.

For **Series operation in Controlled-Current mode**, you should select one amplifier to be operated as the “Master” amplifier of the system, and then refer to the topic “Controlled Current Operation” in the *Applications* section of this manual for instructions on configuring this amplifier for operation in Controlled-Current mode. After the Master amplifier is configured and tested for Controlled-Current operation, refer to the topic “Multiamp Systems for Increased Current or Voltage” in the *Applications* section of this manual for information on Series system configuration.

For **Parallel operation in Controlled-Voltage mode**, refer to the topic “Multiamp Systems for Increased Current or Voltage” in the *Applications* section of this manual for information on Parallel system configuration.

**CAUTION: DO NOT operate paralleled amplifiers in Controlled-Current mode without first contacting AE Techron Technical Support for assistance.**

#### 3.2 Connecting the Load

##### 3.2.1 Preparation and Cautions

**Before connecting the amplifier, make sure the AC power is disconnected.**



Always use the appropriate wire size and insulation for the maximum current and voltage expected at the output. Never connect the output of the amplifier to any other model amplifier, power supply, signal source, or other inappropriate load; fire can result.

### 3.2.2 Connecting the Outputs

Connection to the output of the amplifier is to a 3-position terminal strip with #8 screws. Wires terminated with #8 ring terminals, tinned wires up to 10 AWG in size, or bus bars with 0.18 in. (4.6 mm) holes are recommended when connecting to the output terminals. Connect the load across the terminals marked "OUTPUT" (positive) and "COM" (negative/ground). The third terminal, "CHASSIS GROUND" can be connected to an external ground point such as the rack chassis. See **Figure 3.2**.

**IMPORTANT: DO NOT connect the load to the "CHASSIS GROUND" terminal.**

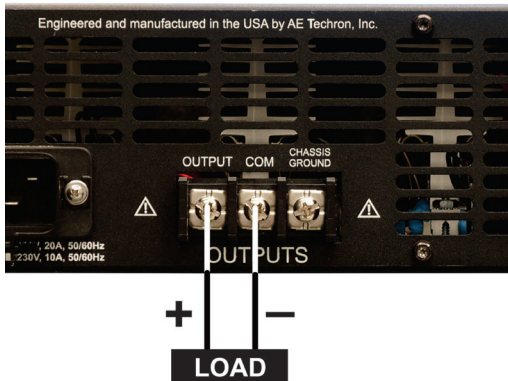

Figure 3.2 – Connecting the Load

### 3.3 Connecting the Input Signal

The signal is connected to the amplifier through a "SIM" (Specialized Input Module) card located on the amplifier back panel. This standard SIM2 BNC card can easily be removed and replaced with alternate SIM cards designed for special applications, when required.

The SIM2 BNC card provides both an unbalanced Input BNC jack and a balanced Input "WECO" terminal block connector. Connect your input signal to the unbalanced or balanced input connector as shown in **Figure 3.3**. Use cables that are

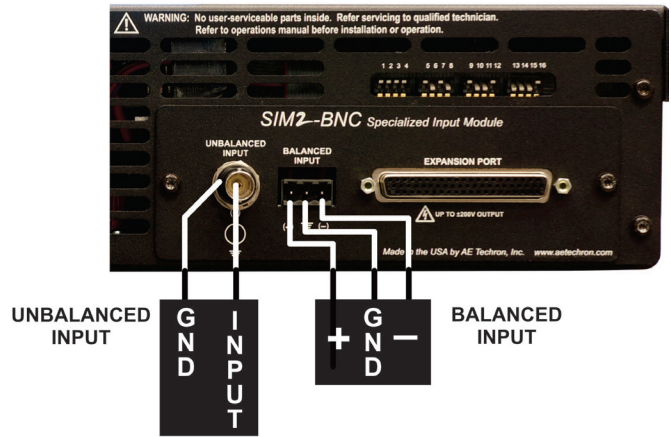

Figure 3.3 – Wiring for Unbalanced or Balanced Input Connector

high quality and shielded to minimize noise and to guard against possible feedback.

DIP switch #5, located on the DIP switch panel above the SIM card, can be used to select balanced or unbalanced input wiring, and also can function as a ground-lift switch for the BNC input connector (see **Figure 3.4**). DIP switch #5 func-

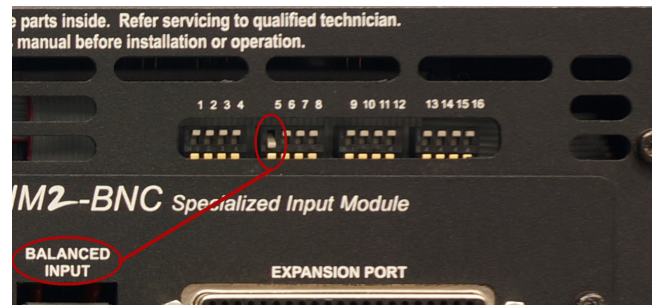

Figure 3.4 – DIP Switch Panel Location

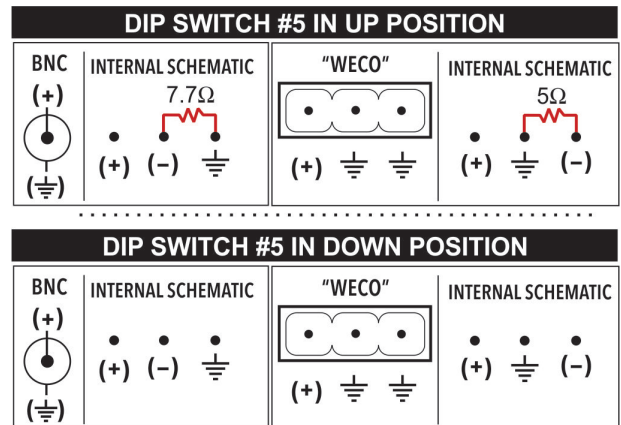

Figure 3.5 – Wiring for Unbalanced or Balanced Input Connector

tions by connecting/disconnecting the inverting (–) pin on each input connector to the amplifier ground through a 5-ohm resistor (see **Figure 3.5**).

When DIP switch #5 is placed in the UP position (factory default), the shield on the BNC connector and the inverting (–) pin on the terminal block connector are tied to the amplifier ground, allowing the connectors to be used for Unbalanced input wiring.

When DIP switch #5 is placed in the DOWN position, the inverting pin on the terminal block connector is floating, allowing the connector to be used for balanced input wiring.

**IMPORTANT: DIP switch #5 can also function as a Ground Lift switch for the BNC Input connector. If circulating currents/ground loops/60-Hz Hum occur when using the BNC Input, move DIP switch #5 to the DOWN position to lift the ground on the connector.**

### 3.4 Other DIP Switch Settings

Other DIP switches can be used to enable features or configure the amplifier for special applications. See the **Advanced Configuration** section of this manual for more information. Before operating the amplifier, check to make sure all DIP switches are set as intended. The factory default setting for all DIP switches is the UP position.

### 3.5 Using the Expansion Port

The Expansion Port can be used to provide remote control and monitoring of the amplifier. See the **Applications** section of this manual for information on using the Expansion Port connector for remote applications.

### 3.6 Connecting the AC Supply

The power cord connects to a standard 20A 3-pin IEC-type male connector on the back panel (see **Figure 3.6**). Make sure the Breaker/Switch on the front panel is switched to the OFF (O) position. Make sure the power cord is inserted and seated fully into the IEC connector by moving it slightly back and forth and up and down while pushing in. The power cord is relatively stiff and should be routed so that there is no excessive force pulling to the sides or up or down that would stress the pins or internal connections.

### 3.7 Start-up Procedure

1. Turn down the level of your signal source.
2. Turn down the gain control of the amplifier.
3. Depress the POWER switch to turn the amplifier ON.
4. Wait for the yellow READY and green RUN LEDs to illuminate.
5. Turn up the Gain control on the amplifier until the desired voltage or power level is achieved.
6. Adjust the input signal level to achieve the desired output level.

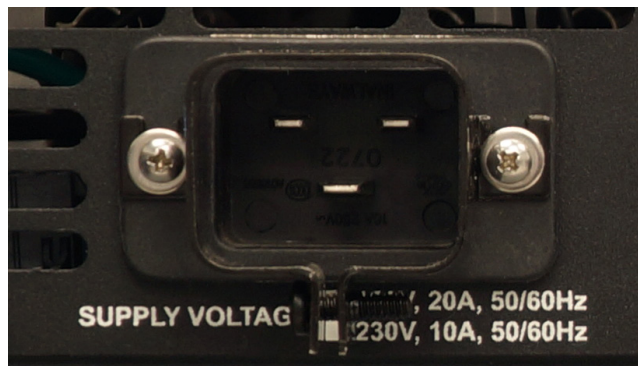

Figure 3.6 – Closeup of AC Mains Outlet

## 4 Amplifier Operation

### 4.1 Front-Panel Controls

This section provides an overview of Front-Panel controls and indicators found on the 7228.

#### 4.1.1 Power Switch

The Power Switch controls the AC mains power to the amplifier. Switch to the ON position (I) to turn the amplifier on. Switch to the OFF position (O) to turn the amplifier off. See **Figure 4.1**.

The Power Switch also serves as a Breaker. When the Breaker is tripped, the Power Switch moves to a neutral position between ON and OFF. To reset the Breaker, turn the amplifier OFF (O) and then turn it back ON (I).

#### 4.1.2 Gain Control

The Gain Control Knob increases/decreases the gain from 0 – 100% of the overall Gain (factory default Gain is 20V/V in voltage mode and 5A/V in current mode). Turn the Gain Control fully clockwise for maximum amplifier output. See **Figure 4.2**. See the **Advanced Configuration** section for information on how to make the amplifier fixed-gain.

#### 4.1.3 Push Buttons

##### Run and Standby Conditions

The 7228 provides three front-panel soft-touch Push Buttons that control two basic operating conditions: (1) **Run condition** (the high-voltage transformers are energized and the unit will amplify the input signal); and (2) **Standby condition** (the low-voltage transformer is energized but the high-voltage transformers are not and the unit will not amplify the input signal).

By default, the amplifier will automatically enter the Run condition on power-up. To change the factory-default setting and configure the amplifier to power-up in Standby/Stop mode, please see the **Advanced Configuration** section.

The amplifier will enter one of four Standby modes under the following conditions:



Figure 4.1 – Power Switch



Figure 4.2 – Gain Control

**Standby mode (Standby LED lit):** The amplifier will enter Standby mode if the Ground Loop Protection Circuit detects a ground loop or excess circulating currents. Eliminate the ground loop and the amplifier will automatically return to Run mode.

In addition, setting improper DIP switch combinations will cause the amplifier to enter Standby mode.

1. If the DC Servo DIP switch (#11) is set in the DOWN position while the Input Coupling DIP switch (#6) is set in the UP position, the amplifier will enter Standby mode. Change the DC Servo switch to the UP position or change the Input Coupling switch to the DOWN position, and the amplifier will automatically return to Run mode.
2. If the Current Limit DIP switches (#13 to #16) are all placed in the DOWN position, the amplifier will enter Standby mode. Change as least one of these four switches



to the UP position and the amplifier will automatically return to Run mode.

**Remote Standby mode (Ready and Standby LEDs lit):** The amplifier is functioning properly and all Fault Status modes are clear, but the unit has been placed in Standby by an external condition.

If the amplifier has been configured as a Series Slave (DIP switch #1 DOWN), it will enter Remote Standby mode when the Enable button is pressed and remain in that mode until it receives the Enable signal from an interlocked Master amplifier.

If an amplifier is disabled using a Remote Standby switch, the amplifier will be placed in Remote Standby mode. To return the amplifier to a Run condition, release the Standby condition using the remote switch. See the **Applications** section of this manual for more information on remote amplifier operation.

**Standby/Fault mode (Standby and one or more Fault LEDs lit):** The amplifier has been placed in Standby due to an Output, Overload, Over Temp or Over Voltage condition. See the section “Fault Status Indicators” to determine the fault condition being indicated and the action required to clear the fault condition.

**Standby/Stop mode:** The amplifier has been placed in Standby due to a Stop order or a Stop condition: The Stop button on the amplifier front panel has been pushed, some DIP switches have been changed or placed in improper configurations, or the amplifier has been configured to enter Stop mode on startup. See the “**Advanced Configuration**” section for information about configuring the amplifier for Startup in Stop mode.

### Enable, Stop and Reset Buttons

The following details the results when each of the three Push Buttons are pressed on the amplifier front panel. See **Figure 4.3** for Push Button locations.



Figure 4.3 – Push Buttons

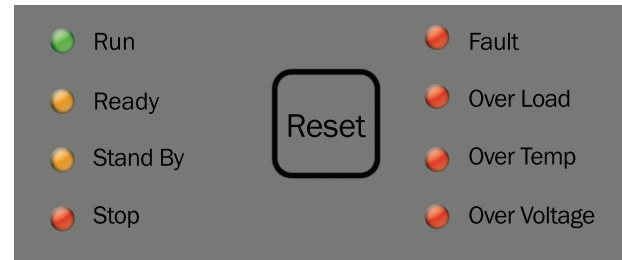

Figure 4.4 – Main Status and Fault Status Indicators

**Enable** – When the amplifier is in Standby/Stop mode, pressing the Enable button will release the amplifier from Standby and place the amplifier in Run mode. If the Enable button does not release the amplifier from Standby/Stop mode, check to see if both the Series Mode (#1) and Parallel Mode (#2) DIP switches are in the DOWN position. Place one or both switches in the UP position and then press the Enable button to release the amplifier from Standby/Stop mode.

**Stop** – Pressing the Stop button will place the amplifier in Standby/Stop mode (both Standby and Stop LEDs will be lit).

**Reset** – When the amplifier has been placed in Standby/Fault mode due to a fault condition, pressing the Reset button will return the amplifier to Run mode if the condition causing the fault condition has been cleared and the amplifier has been configured for startup in Run mode. If the amplifier has been configured for startup in Stop mode, pressing the Reset button will place the amplifier in Standby/Stop mode. Press the Enable button to return the amplifier to Run mode.



**4.2 Front-Panel Indicators**

**4.2.1 Main Status Indicators**

Four Main Status indicators are located on the amplifier's front-panel (see **Figure 4.4**). These LEDs monitor the internal conditions of the amplifier and indicate the current state of operation. The chart in

**Figure 4.5** details the operational modes indicated by the Main Status indicators.

**NOTE:** See the **“Applications”** section for main status indicator interpretation when operating a multi-amp system.

**Figure 4.5 – Main Status Indicators**

● ● ● Indicator is lit   ● Indicator is not lit   ○ Indicator may be lit

Main Status Indicators	State of Operation	Action Needed to Return to Run Mode
<ul style="list-style-type: none"> <li>● Run</li> <li>● Ready</li> <li>● Standby</li> <li>● Stop</li> </ul>	<p><b>Run mode:</b> The amplifier's high-voltage transformers are energized and the unit will amplify the input signal. Run mode is initiated by: (1) the Enable push button, or (2) when the amplifier powers up in Run mode (factory default). See the <b>Advanced Configuration</b> section for more information.</p>	N/A
<ul style="list-style-type: none"> <li>● Run</li> <li>● Ready</li> <li>● Standby</li> <li>● Stop</li> </ul>	<p><b>Standby mode:</b> Standby mode indicates that the amplifier has been placed in Standby because: 1) Ground loop and/or circulating currents have triggered the ground-loop protection circuit; or 2) Some combinations of DIP switches have been set improperly. In Standby mode, the amplifier's low-voltage transformer is energized but the high-voltage transformers are not.</p>	<p>Check to see if one of the following improper DIP switch combinations has been set: <b>#6 UP</b> and <b>#11 DOWN</b>, or <b>#13 - #16 all DOWN</b>. To release the amplifier from Standby mode, change the improper setting and the amplifier will automatically return to Run mode. If the switches are set properly but the amp remains in Standby, eliminate ground loop conditions and the amp will automatically return to Run mode.</p>
<ul style="list-style-type: none"> <li>● Run</li> <li>● Ready</li> <li>● Standby</li> <li>● Stop</li> </ul>	<p><b>Remote Standby mode:</b> Remote Standby mode indicates that the amplifier is functioning properly and all Fault Status modes are clear, but it is being held in Standby by an external condition. As configured from the factory (Run mode on startup), the amplifier will enter Remote Standby mode briefly after powering up, and then will move automatically into Run mode. In Remote Standby mode, the amplifier's low-voltage transformer is energized but the high-voltage transformers are not.</p>	<p>If the amplifier remains in Remote Standby mode, it is:                      1) Being held in Standby by remote control through the Expansion Port; or 2) Has been configured as a Slave amplifier for Series operation. If the amplifier has been configured as a Series Slave (DIP switch #1 DOWN), it will automatically enter Run mode when the interlocked Master amplifier enters Run mode. Or place DIP switch #1 in the UP position and then press the Enable button to return to Run mode. If the amp has a remote Standby switch, activate the switch to clear the Remote Standby condition and return the amplifier to Run mode. See the <b>Applications</b> section of this manual for more information on remote amplifier operation.</p>
<ul style="list-style-type: none"> <li>● Run</li> <li>● Ready</li> <li>● Standby</li> <li>● Stop</li> </ul>	<p><b>Standby/Stop mode:</b> The amplifier will enter Standby/Stop mode: 1) When the Stop button on the amplifier front panel is pressed; 2) After powering up if the amplifier is configured to enter Stop mode on startup; 3) When certain DIP switch settings are changed while the amplifier is in Run mode; or 4) When both Series Mode (SW#1) and Parallel Mode (SW#2) are placed in the DOWN position. In Standby/Stop mode, the amplifier's low-voltage transformer is energized but the high-voltage transformers are not.</p>	<p>To release the amplifier from Standby/Stop mode, press the Enable button. If the amplifier will not release from Standby/Stop mode, check to see if both DIP switches <b>#1</b> and <b>#2</b> are in the <b>DOWN</b> position. Place one or both switches in the UP position, and then press the Enable button to release the amplifier from Standby/Stop mode.</p>

### 4.2.2 Fault Status Indicators

Four Fault Status indicators are located on the amplifier front panel (see **Figure 4.4**). These LEDs monitor the internal conditions of the amplifier and will illuminate when a fault condition occurs.

Depending on the fault condition and the configuration of the unit, the amplifier may be placed in Standby/Fault mode when a fault condition occurs. Refer to the chart in **Figure 4.6** to determine

**Figure 4.6 – Fault Status Indicators**

● ● ● Indicator is lit   ● Indicator is not lit   ○ Indicator may be lit

Main Status Indicators	Fault Status Indicators	State of Operation	Action Needed to Clear Fault Condition and Return to Run Mode
<ul style="list-style-type: none"> <li>● Run</li> <li>● Ready</li> <li>● Standby</li> <li>● Stop</li> </ul>	<ul style="list-style-type: none"> <li>● Fault</li> <li>● Over Load</li> <li>● Over Temp</li> <li>● Over Voltage</li> </ul>	<p><b>Output Fault status:</b> This indicates that an Output Fault condition has occurred and the amplifier has been placed in Standby mode. The Fault indicator will light under two conditions: 1) High-frequency oscillation is causing high shoot-through current; or 2) An output transistor has shorted, causing the output fault condition.</p>	<p>This fault condition cannot be cleared using the front-panel Reset button. See the <b>Troubleshooting</b> section for more information on diagnosing and clearing this fault condition.</p>
<ul style="list-style-type: none"> <li>● Run</li> <li>● Ready</li> <li>○ Standby</li> <li>● Stop</li> </ul>	<ul style="list-style-type: none"> <li>● Fault</li> <li>● Over Load</li> <li>● Over Temp</li> <li>● Over Voltage</li> </ul>	<p><b>Over Load status:</b> This indicates that the output of the amplifier could not follow the input signal due to voltage or current limits. Under normal operation with the factory-default settings, an Over Load condition will not place the amplifier in Standby mode. If the amplifier has been configured to be forced to Standby on Over Load, the amplifier will be placed in Standby mode when the Over Load indicator lights.</p>	<p>To remedy the Over Load fault during operation, turn down the level of the input signal until the Over Load indicator turns off. To clear an Over Load fault condition when the amplifier is forced to Standby, turn down the level of the input signal, then push the Reset button.</p>
<ul style="list-style-type: none"> <li>● Run</li> <li>● Ready</li> <li>● Standby</li> <li>● Stop</li> </ul>	<ul style="list-style-type: none"> <li>● Fault</li> <li>● Over Load</li> <li>○ Over Temp</li> <li>● Over Voltage</li> </ul>	<p><b>Over Temp status:</b> The amplifier monitors the temperature inside the high-voltage transformers, low-voltage transformer and in the output stage heat sinks. The Over Temp indicator will light and the amplifier will be placed in Standby mode when the temperature sensors detect a condition that would damage the amplifier. If the Over Temp pulse is extremely short, as in the case of defective wiring or switches, the Over Temp LED may be lit too briefly to observe.</p>	<p>To reset after an Over Temp fault has occurred, make sure the fans are running, and then remove the input signal from the amplifier. Note that the fans will automatically switch to high-speed operation on an Over Temp condition. Allow the fans to run for about 5 minutes, or until the fans switch to low-speed operation (fans will not move to low-speed operation if they have been configured for continuous high-speed operation). Push and hold the Reset button until the Standby LED turns off, and then release the Reset button to return the system to Run mode. See the <b>Troubleshooting</b> section for information on correcting the cause of an Over Temp fault condition.</p>
<ul style="list-style-type: none"> <li>● Run</li> <li>● Ready</li> <li>● Standby</li> <li>● Stop</li> </ul>	<ul style="list-style-type: none"> <li>● Fault</li> <li>● Over Load</li> <li>● Over Temp</li> <li>● Over Voltage</li> </ul>	<p><b>Over Voltage status:</b> This indicates that the AC mains voltage is more than +10% of nominal. The amplifier will be forced to Standby when an Over Voltage condition occurs. When the Over Voltage condition is cleared, the amplifier will automatically return to Run mode.</p>	<p>To clear an Over Voltage fault condition, the AC mains must be brought down to the nominal value. Once the Over Voltage condition has been cleared, press the Reset button to return the amplifier to Run mode. If the amplifier does not return to Run mode, the amplifier may require servicing. Please see the <b>Troubleshooting</b> section for more information.</p>

the fault condition being indicated and the action required to clear the fault condition.

**NOTE:** See the “*Applications*” section for fault status indicator interpretation when operating a multi-amp system.

### 4.3 Back-Panel Controls and Connectors

This section provides an overview of Back-Panel controls and connectors found on the 7228. Please refer to **Figure 4.7** for visual locations.

**AC Supply** – Standard 20 amp 3-pin IEC-type male connector.

**Output Terminal Strip** – Connect output lines from the load to this 3-position terminal strip with #8 screws. It accepts up to 10 AWG wire.

**Unbalanced BNC Input Connector** – This input option provides a standard unbalanced input.

**Balanced WECO Input Connector** – This input option provides a balanced input.

**Expansion Port** – This 62-pin, D-sub connector can be used for a variety of remote control and monitoring applications. It is also used for interlocking and combining functions in a system of multiple amplifiers. See the “*Applications*” section for more information.

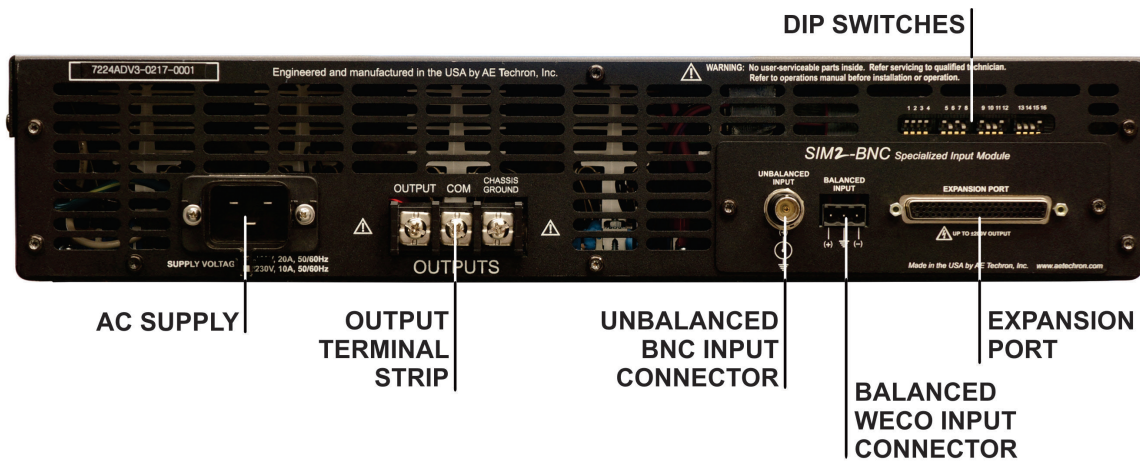

Figure 4.7 – Back Panel Controls and Connectors

## 5 Advanced Configuration

The 7228 amplifier was designed to offer exceptional versatility in operation. You can choose from a range of field-configurable options, including:

- Operate as a stand-alone amplifier or as part of a multiple-amplifier system.
- Select DC-coupled or AC-coupled operation.
- Select Controlled-Current or Controlled-Voltage modes of operation.
- Configure the bi-level power supply for use in high voltage applications, high current applications, or for applications requiring mid-level amounts of both voltage and current.
- Limit current output via programmable current limits.

- Enable DC Servo to ensure DC offset remains at zero and safely drive coils and transformers.
- Change the maximum amplifier gain from 20:1 to 6:1.
- Operate with variable gain control or at a fixed gain setting of 20.
- Configure the amplifier to enter Standby on startup
- Configure the amplifier to enter Standby when an overload condition occurs.
- Configure the automatic multi-speed fans to operate always on high-speed, or always on low-speed with an automatic change to high speed when required.

Sw #	Down	Up (default)	Description
1	Slave	Master	Series Mode
2	Slave	Master	Parallel Mode
3	On	Off	Parallel Matching
4	Lifted	Connected	Signal Ground
5	Balanced	Unbalanced	Input Signal
6	AC	DC	Input Coupling
7	Current	Voltage	Controlled Mode
8	Manual	Auto	Bi-Level Mode
9	High	Low	Manual Bi-level Mode
10	HC (90V)	HV (180V)	Power Supply Rail Mode
11	On	Off	DC Servo
12	6:1	20:1	Gain
13	Off	On	Current Limit bit 3 (32A)
14	Off	On	Current Limit bit 2 (16A)
15	Off	On	Current Limit bit 1 (8A)
16	Off	On	Current Limit bit 0 (4A)

Figure 5.1 – DIP Switch Settings and Descriptions

### 5.1 DIP Switch Configurations

The 7228 amplifier provides 16 DIP switches located on the amplifier back panel above the SIM2 BNC card. Most configuration settings can be made using these DIP switches. See **Figure 5.1** for DIP switch settings and descriptions.

#### SW#1: Series Mode

When this switch is in the UP position (default), the amplifier will function as a stand-alone amplifier or

as a Master amplifier in a series-connected multi-amp system. When this switch is in the DOWN position, the amplifier will function as a Slave amplifier in a Series multi-amp system.

**NOTE:** If the Series Mode DIP switch is placed in the DOWN position while the amplifier is enabled, the amplifier will temporarily be placed in Standby/ Stop mode. Press the Enable button to release the

amplifier from Standby/Stop mode and enter Remote Standby mode. The amplifier will remain in Remote Standby mode until it receives the Enable signal from an interlocked Master amplifier.

If the Series Mode DIP switch is placed in the DOWN position while the Parallel Mode DIP switch is also in the DOWN position, the amplifier will be placed in Standby/Stop mode. Pressing the Enable button will not release the amplifier until at least one of the Series Mode or Parallel Mode DIP switches is placed in the UP position.

For more information on multi-amplifier system configuration and operation, see the **Applications** section.

#### **SW#2: Parallel Mode**

When this switch is in the UP position (default), the amplifier will function as a stand-alone amplifier or as a Master amplifier in a multi-amp system. When this switch is in the DOWN position, the amplifier will function as a Slave amplifier in a Parallel multi-amp system.

**NOTE:** If the Parallel Mode DIP switch is placed in the DOWN position while the Series Mode DIP switch is also in the DOWN position, the amplifier will be placed in Standby/Stop mode. Pressing the Enable button will not release the amplifier until at least one of the Series Mode or Parallel Mode DIP switches is placed in the UP position.

For more information on multi-amplifier system configuration and operation, see the **Applications** section.

#### **SW#3: Parallel Matching**

The Parallel Matching function serves to minimize circulating currents when multiple amplifiers are used in a parallel configuration. When enabled, the Parallel Matching function progressively increases impedance from the voltage gain as current increases, up to a maximum 0.10-ohm increase. This allows the amplifiers to operate in parallel without the use of separate ballast resistors in multi-amp applications up to 20 kHz. For more information on multi-amplifier system configuration and operation, see the **Applications** section.

When the Parallel Matching DIP switch is in the UP position (default), the Parallel Matching function is disabled. When this switch is in the DOWN position, Parallel matching is enabled.

#### **SW#4: Signal Ground**

When the Signal Ground DIP switch is in the UP position (default), the amplifier's negative (–) output terminal is connected to ground through a PTC (resettable fuse) that protects the amplifier from ground loops, circulating currents, and other potentially harmful conditions. The PTC will tolerate up to 30V delta between signal and chassis ground before a fault condition is triggered and the amplifier is placed in Standby. To release the amplifier from Standby, remedy the cause of the fault condition, and the amplifier will automatically be returned to operational conditions.

When this switch is in the DOWN position, the PTC is bypassed, disabling the Ground Loop protection.

Bypassing the PTC connection is required for proper Series operation, but this is done automatically when the Series Mode DIP switch (SW #1) is placed in the DOWN position, so changing the Signal Ground DIP switch setting is not required for proper Series operation. For more information on multi-amplifier system configuration and operation, see the **Applications** section.

**NOTE:** If the Signal Ground DIP switch is placed in the DOWN position while the amplifier is enabled, the amplifier will temporarily be placed in Standby/Stop mode. Press the Enable button to release the amplifier.

#### **SW#5: Input Signal**

When the Input Signal DIP switch is in the UP position (default), the negative (–) pole of the input connector is connected to ground on both the BNC and the WECO input connectors. In this configuration, both BNC and WECO input connectors can operate as unbalanced inputs. When this switch is in the DOWN position, signal ground is disconnected from the negative pole on both input connectors. In this configuration, the switch functions as a ground-lift switch for the BNC connector



and allows the WECO connector to function as a balanced input.

#### SW#6: Input Coupling

When the Input Coupling DIP switch is in the UP position (default), the amplifier can receive and amplify both DC and AC signal. When this switch is in the DOWN position, a 2-Hz high-pass filter on the inputs prevents the transmission of DC signal.

**NOTE:** Both the Input Coupling and DC Servo DIP switches must be placed in the DOWN position when activating the DC Servo function. Placing the Input Coupling DIP switch in the UP position and the DC Servo DIP switch in the DOWN position will cause the amplifier to be placed in Standby/Stop mode. To return the amplifier to operational conditions, set both the DC Servo and the Input Coupling DIP switches in the DOWN position or place the DC Servo Switch in the UP position.



### CAUTION

In Controlled-Current Mode, the load is part of the amplifier circuit, and the relationship of the load to the amplifier is critical. For proper and safe operation in Controlled-Current mode, you must observe the following guidelines:

1. **Properly attach a load before operating the amplifier.**
2. **DO NOT use a blocking capacitor.** The load must have a DC path.
3. **Never leave the load open.** If you feel the load must be fused, which could lead to a potential open circuit, please contact AE Techron Technical Support.
4. **Make sure the load has some inductive component.**
5. **Provide appropriate compensation for the load.**
6. **If oscillation occurs, turn off the amplifier immediately.**

**Failure to follow these guidelines may result in damage to the amplifier or load.**

#### SW#7: Controlled Mode

When the Controlled Mode DIP switch is in the UP position (default), the amplifier will operate in Controlled-Voltage mode, and the amplifier's output voltage will be controlled by its input voltage signal. When this switch is in the DOWN position, the amplifier will operate in Controlled-Current mode, and the amplifier's output current will be controlled by its input voltage signal.

**IMPORTANT:** Controlled-Current operation requires the use of a compensation network, and the 7228's default compensation network may not be

suitable for your application. For more information on Controlled-Current operation, including how to determine and configure a custom compensation network, see the **Applications** section.

**NOTE:** If the Controlled Mode DIP switch setting is changed while the amplifier is enabled, the amplifier will temporarily be placed in Standby/Stop mode. Press the Enable button to release the amplifier.

#### SW#8: Bi-level Mode

When the Bi-level Mode DIP switch is in the UP position (default), the amplifier will automatically switch the power supply transformers between a series and a parallel configuration, depending on the present voltage requirements of the application. When this switch is in the DOWN position, the amplifier will not switch automatically, but will operate according to the Manual Bi-level Mode DIP switch setting (SW #9). For more information on how to set the Bi-level Mode DIP switch for increased voltage or current, see the **Applications** section.

#### SW#9: Manual Bi-level Mode

The Manual Bi-level Mode switch is enabled when the Bi-level Mode switch (SW#8) is set to Manual (DOWN position). Once enabled, the amplifier will operate with the power supply transformers in a series configuration when the Manual Bi-level Mode DIP switch is in the UP position (default). When this switch is in the DOWN position, the amplifier will operate with the power supply transformers in a parallel configuration. For more information on how to set the Manual Bi-level Mode DIP switch for increased voltage or current, see the **Applications** section.

#### SW#10: Power Supply Rail Mode

When the Power Supply Rail Mode DIP switch is in the UP position (default), the amplifier will operate with the power supply rails in a series configuration for high-voltage output. When this switch is in the DOWN position, the amplifier will operate with the power supply rails in a parallel configuration for high-current output. For more information on how to set the Power Supply Rail Mode DIP switch for

increased voltage or current, see the **Applications** section.

**NOTE:** If the Power Supply Rail Mode DIP switch setting is changed while the amplifier is enabled, the amplifier will temporarily be placed in Standby/Stop mode. Press the Enable button to release the amplifier.

**SW#11: DC Servo**

The DC Servo function ensures that no DC offset is present at the signal output (-3 dB at 20 Hz). Select DC Servo when driving transformers or other coils. When the DC Servo DIP switch is in the UP position (default), the DC Servo function is disabled. When this switch is in the DOWN position, the DC Servo function is enabled.

**NOTE:** Both the Input Coupling and DC Servo DIP switches must be placed in the DOWN position when activating the DC Servo function. Placing the Input Coupling DIP switch in the UP position and the DC Servo DIP switch in the DOWN position will cause the amplifier to be placed in Standby/Stop mode. To return the amplifier to operational conditions, set both the DC Servo and the Input Coupling DIP switches in the DOWN position or place the DC Servo Switch in the UP position.

**SW#12: Gain**

When the Gain switch is in the UP position, the amplifier's maximum gain will be 20:1. Placing the Gain switch in the DOWN position will change the amplifier's maximum gain to 6:1.

**SW#13 - #16: Current Limit**

These four switches control the current-limit settings for the amplifier. When all four switches are in the UP position (default), the amplifier's output current is limited to 60A. The current-limit can be lowered in 4A increments by setting one or more of the current limit switches in the DOWN position. Refer to **Figure 5.2** for all available current-limit switch settings.

**NOTE:** If all four current-limit DIP switches are set in the DOWN position, the amplifier will be placed in Standby/Stop mode. To return the amplifier

ON = DIP Switch UP    OFF = DIP Switch DOWN				
SW#13	SW#14	SW#15	SW#16	Current Limit
ON	ON	ON	ON	60A
ON	ON	ON	OFF	56A
ON	ON	OFF	ON	52A
ON	ON	OFF	OFF	48A
ON	OFF	ON	ON	44A
ON	OFF	ON	OFF	40A
ON	OFF	OFF	ON	36A
ON	OFF	OFF	OFF	32A
OFF	ON	ON	ON	28A
OFF	ON	ON	OFF	24A
OFF	ON	OFF	ON	20A
OFF	ON	OFF	OFF	16A
OFF	OFF	ON	ON	12A
OFF	OFF	ON	OFF	8A
OFF	OFF	OFF	ON	4A
OFF	OFF	OFF	OFF	FAULT

Figure 5.2 – Current Limit Switch Configurations

to operational conditions, set at least one of the current-limit DIP switches in the UP position.

**5.2 Internal Jumpers and Settings**

The 7228 amplifier contains two circuit boards with jumpers that can be used to alter the amplifier operation from the factory defaults. The Universal Front-End Board (or UFEB) allows you to select the compensation network for use in Controlled-Current operation, configure the amplifier to operate with a fixed gain instead of the default variable gain, insert a 50-kHz low-pass filter, configure the amplifier to enter Standby on startup instead of entering Run mode (default), and configure the amplifier to enter Standby when an Overload fault condition occurs. The Interconnect Board allows selection of two always-on modes of operation for the amplifier's multi-speed cooling fans.

The UFEB and Interconnect boards can be accessed by removing the amplifier top cover. To remove the amplifier top cover, complete the steps detailed in the following section.



**! DANGER**

Uninsulated terminals with AC mains potential are exposed when the top cover is removed. Do not proceed until the amplifier has been turned off and the AC Mains has been disconnected.

**! CAUTION**

After turning the amplifier off, let the unit sit for 3-5 minutes before removing the top cover. This will allow the electrical charge in the power supply capacitors to discharge.

2. Use the T-15 Torx wrench to remove the eight (8) Torx screws, as shown in **Figure 5.3**.
3. Lift the cover straight up to remove and set aside.
4. To replace the top cover, slide the cover in to place on the amplifier and replace the eight screws.

Refer to **Figure 5.4** for UFEB and Interconnect board locations.

Refer to **Figure 5.5** for UFEB and Interconnect board jumper locations.

**5.2.1 Amplifier Top Cover Removal**

**Tool Required**

T-15 Torx wrench

**Procedure**

1. Remove power from the amplifier and disconnect any load from the amplifier outputs. Wait a minimum of three minutes to allow the amplifier's capacitors to discharge.

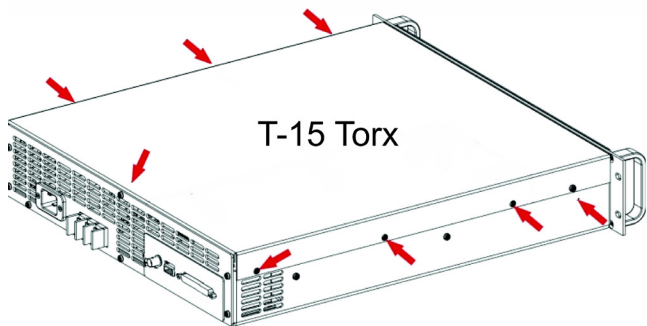

Figure 5.3 – Removing the Amplifier Top Cover

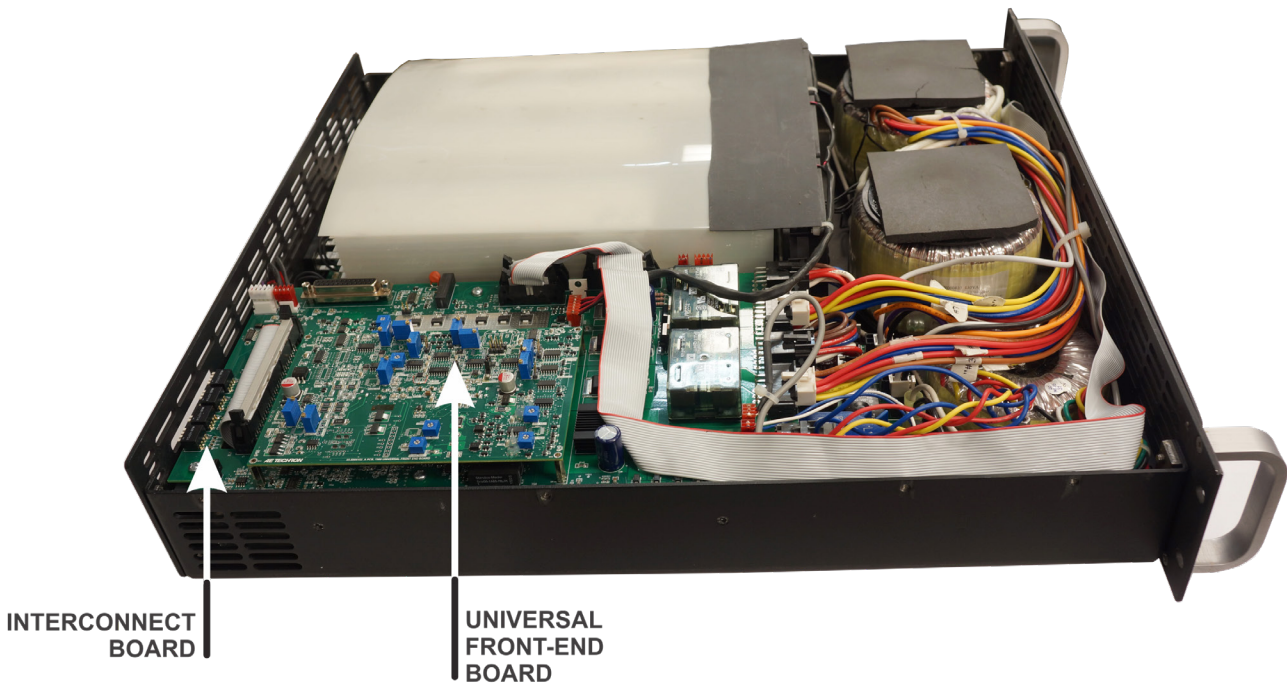

Figure 5.4 – UFEB and Interconnect Board Locations

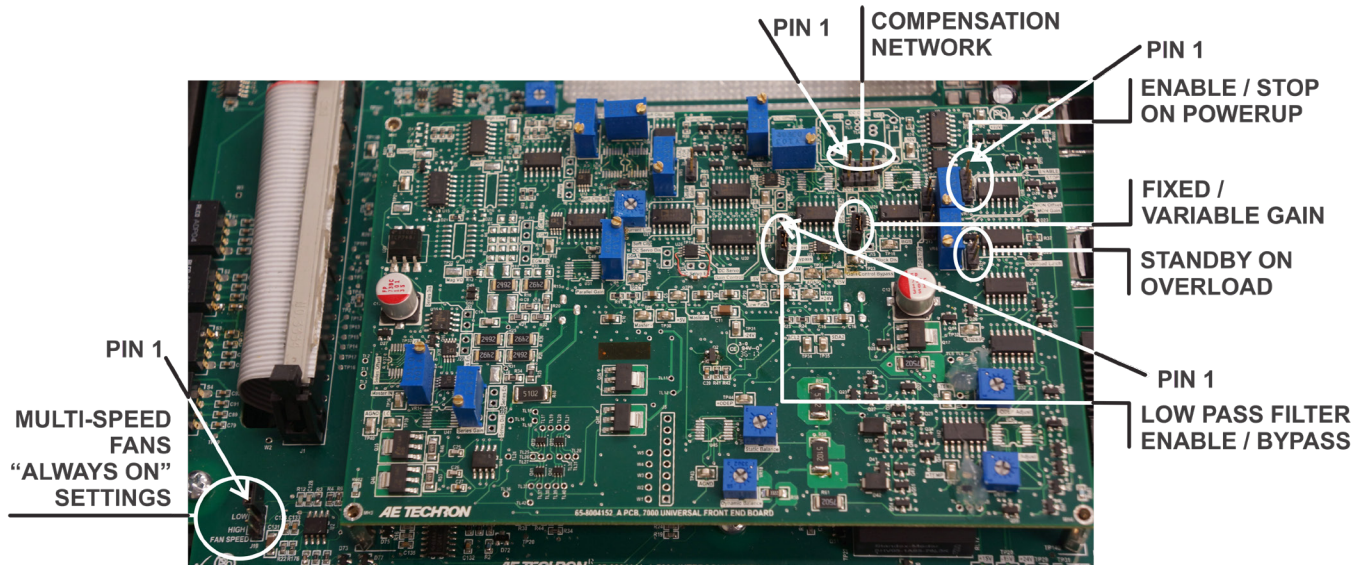

Figure 5.5 – UFEB and Interconnect Board Jumper Locations

**5.2.2 Jumper Settings on the Universal Front-End Board**

**Compensation Network**

When the 7228 amplifier is used in Controlled-Current mode, the current control loop is tuned with an RC network. The factory default network (CC1) provides **75k ohm resistance** and **47 nF** capacitance. If this default network is not adequate for your application and load, CC2 can be used to install a custom RC network.

To change the compensation network, locate the Compensation Network jumper (see Figure 5.5). When **pins 1 and 2** are jumpered (factory default), network **CC1** is enabled (75k ohm and 47 nF). To select network **CC2**, place the shunt on the jumper across **pins 2 and 3**.

Remove the shunt from the jumper to disable both CC1 and CC2 networks. A small feedback capacitor remains in the circuit to provide stability when operating into an 8-ohm load. For more information on Controlled-Current operation and installing a custom RC network, see the **“Applications”** section of this manual.

**Enable/Stop on Powerup**

The 7228 amplifier will power-up to **Run Mode** when a shunt is placed across **pins 1 and 2** on the

Enable/Stop jumper (default setting). See Figure 5.5. To cause the 7228 amplifier to enter **Standby (Stop Mode)** on power-up, place the shunt across **pins 2 and 3**.

**Fixed or Variable Gain**

The 7228 amplifier ships with an enabled Gain Control knob, which is located on the amplifier front panel. To disable the **Variable Gain** control and set for a **Fixed Gain**, locate the Gain Control Bypass jumper and place a **shunt across the two pins** at that location. See Figure 5.5.

**Standby on Overload**

The 7228’s IOC (Input/Output Comparator) Distortion Alert circuit continuously compares the waveforms observed at the amplifier input and output. When a distortion between the two waveforms of more than 0.5% occurs, the IOC circuit will activate, and the Overload LED will light, but the amplifier will continue to operate. To configure the 7228 to move to **Standby (Fault mode)** when the IOC circuit is activated, locate the Overload Latch (see Figure 5.5) and place a shunt across the two pins of the jumper.

**Low Pass Filter Enable**

The Low Pass Filter function inserts a 50 kHz (3-dB down) low-pass filter at the amplifier input to

ensure that signals above 50 kHz are not amplified.

To enable the low pass filter, locate the Low Pass/LP Bypass jumpers (see Figure 5.5) and move the shunt from **pins 2 and 3** (LP Bypass) and place across **pins 1 and 2** (Low Pass).

### 5.2.1 Interconnect Board Settings

The multi-speed fans operate under the following criteria (factory default):

- At startup, the fans are **OFF**.
- When the amplifier heat sinks reach a temperature of 37°C, the fans are turned **ON LOW**.
- When the amplifier heat sinks reach a temperature of 44°C and/or the ODEP circuit senses high current above 5V, the fans are turned **ON HIGH**.
- When the amplifier heat sinks cool to a temperature of 40°C, the fans are reduced to **LOW**.
- When the amplifier heat sinks cool to a temperature of 35°C, the fans are turned **OFF**.
- If an Overtemp Fault occurs, the fans will be turned **ON HIGH** and operate in that state until the Overtemp condition is alleviated.

Two alternate configurations are available for the multi-speed fans that will provide “Always-on” operation.

#### Two-speed (low and high) Always-on Operation

- On start-up, the fans will operate in **LOW** speed until the amplifier heat sinks reach a

temperature of 44°C and/or the ODEP circuit senses high current above 5V. When these conditions occur, the fans are turned **ON HIGH**.

- When the amplifier heat sinks cool to a temperature of 40°C, the fans are reduced to **LOW**.
- If an Overtemp Fault occurs, the fans will be turned **ON HIGH** and operate in that state until the Overtemp condition is alleviated.

#### High-speed Always-on Operation

- On start-up, the fans will operate in **HIGH** speed continuously.

#### 5.2.2 Configuring the Fans for Always-on Operation

Complete the following steps to configure the fans for one of the Always-on modes of operation.

1. Remove the amplifier top cover (see the instructions for “**Amplifier Top Cover Removal**” provided previously in this section).
2. Locate the Interconnect Board (see **Figure 5.4**).
3. Locate the Fan Speed Jumper (**J19**) on the Interconnect Board (see **Figure 5.5**).
4. To configure the amplifier for **Two-speed Always-on** operation, place the shunt across **pins 1 and 2 on Jumper J19**.
5. To configure the amplifier for **High-speed Always-on** operation, place the shunt across **pins 2 and 3 on Jumper J19**.

**NOTE:** To return the fan operation to the factory default, remove the shunt from Jumper J19.

## 6 Applications

### 6.1 Power Supply Settings for Increased Voltage or Current

The 7228 amplifier features a bi-level power supply that contains two, dual-secondary transformers. The secondary rails of each transformer and the two transformers themselves can be placed in a series or parallel configuration, as shown in **Figure 6.1**, providing a range of options for operating with increased voltage or current capabilities.

As shipped from the factory, the 7228 is set to operate with the transformer rails configured in series and the dual transformers configured in parallel, providing a voltage potential of 90V.

During normal operation, the 7228 will use the signal received at input to calculate the expected voltage requirements of the application. When voltages higher than 90V are required, the trans-

formers will automatically be switched to a series configuration to provide up to 180V output.

When the 7228 senses that the voltage required has dropped below the 90V limit, the transformers will automatically be returned to a parallel configuration, reducing heat output and increasing operating efficiency.

While this default configuration works well for most applications, some applications, especially those with a voltage requirement near the 90V switching frequency, may require a fixed configuration for maximum continuous operation. For those applications, the Manual Bi-level Mode DIP switch (SW#9) allows the user to select the High setting for a fixed series configuration with higher voltage potential, or the Low setting for a fixed parallel configuration with a lower voltage potential.

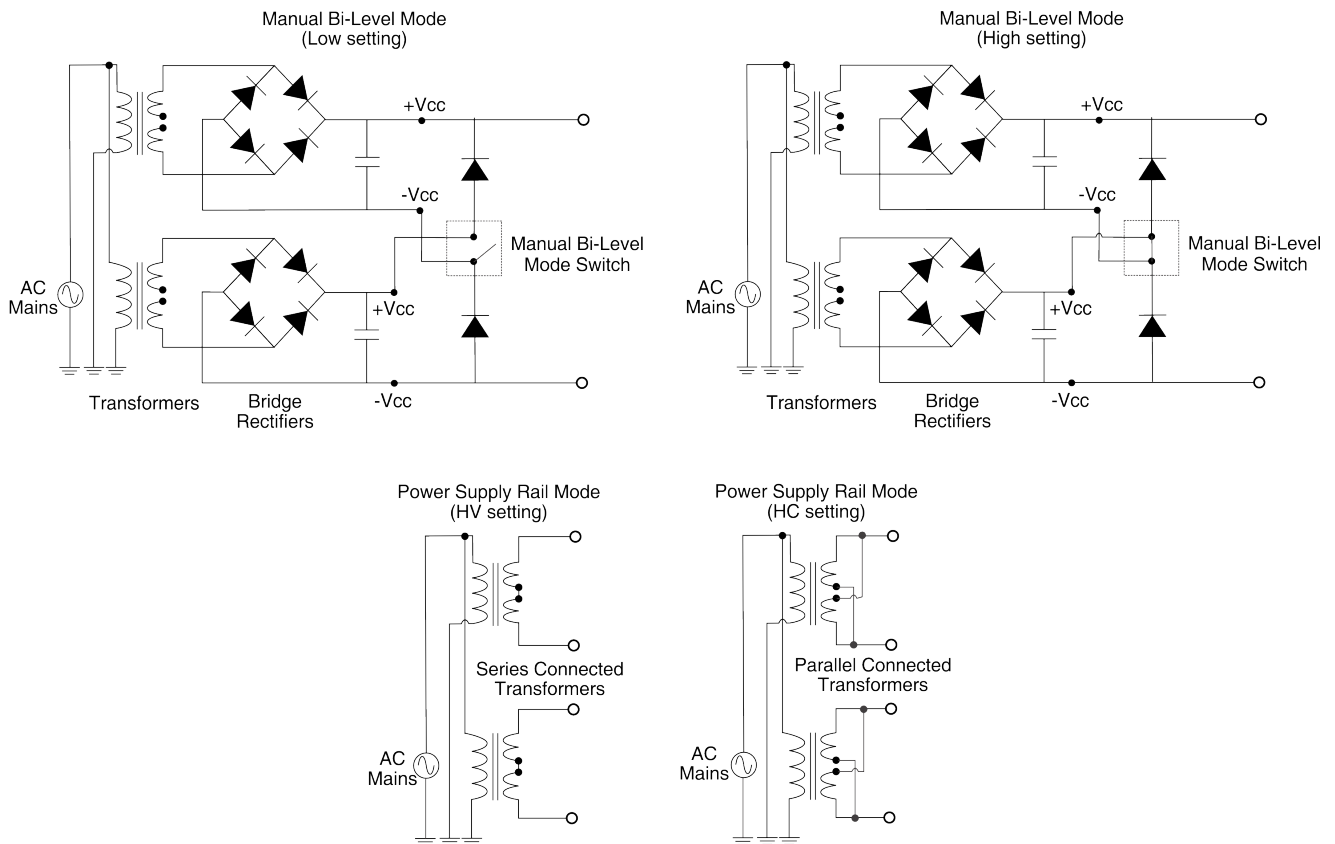

Figure 6.1 – Bi-level Power Supply Settings



In the same way, the two secondaries in each transformer can be configured for a fixed series or parallel operation. Use the Power Supply Rail Mode DIP switch to select the HV setting for a series configuration (default), or the HC setting for a parallel configuration.

Refer to the chart in **Figure 6.2** for recommended applications and expected output voltage based on the various DIP switch settings.

OUTPUT VOLTAGE	LOAD (ohms)		DIP SWITCH SETTING			MANUAL BI-LEVEL	RAIL	RECOMMENDED APPLICATIONS
	Continuous	Pulse	SW#8	SW#9	SW#10			
45	0.5 - 1	0.25 - 0.75	Down	Down	Down	Low	HC	High current operation
45-90	2 - 4	1 - 2	Up	X*	Down	<b>Auto**</b>	HC	Mid-level operation
90			Down	Up	Down	High	HC	Not recommended
90	2 - 4	1 - 2	Down	Up	Up	Low	HV	Fastest rise to >45V; <90V
90-180	8 - 16	4 - 16	Up	X*	Down	<b>Auto**</b>	HV	High voltage operation
180	8 - 16	4 - 16	Down	Down	Up	High	HV	Fastest rise to >90V; <180V

\*SW#8 setting to UP (Auto) overrides SW#9 setting. \*\*Bi-level Mode switch is set to auto to disable the Manual Bi-Level Switch setting.

Figure 6.2 – Recommended Power Supply DIP Switch Settings by Application

## 6.2 Multi-amp Systems for Increased Voltage or Current

The 7228 amplifier may be used with other 7228 amplifiers to increase voltage or current. Because the internal circuitry of a 7228 amplifier is not connected to chassis ground, the amplifier is well suited for use in series or parallel with other 7228 amplifiers.

Two 7228 amplifiers may be configured in series, and up to four may be configured in parallel. Two 7228 amplifiers in series will double the continuous voltage output, while each 7228 amplifier added to a Parallel multi-amp system will increase the continuous current output. See **Figure 6.3** for the approximate output levels you can expect from each multi-amp system.

CONFIGURATION	CONTINUOUS OUTPUT (100% Duty Cycle)
Two in Series	<b>306 Vp</b>
Two in Parallel	<b>90 Ap</b>
Three in Parallel	<b>135 Ap</b>
Four in Parallel	<b>180 AP</b>

Figure 6.3 – Typical Output Levels for 7228 Multiamp Systems

While it is possible to operate a multi-amp system in either Controlled Voltage or Controlled Current modes of operation, multi-amp operation in Controlled Current mode requires additional configuration of the equipment. Please contact **AE Techron Tech Support** for assistance with configuring a multi-amp system for Controlled Current operation.

Configurations with more amplifiers in series or parallel, and combination series/parallel systems may be possible, depending on the application. For more information on these complex multi-amp systems or for assistance in determining the best multi-amp configuration to meet your requirements, please contact **AE Techron Application Support**.

For routine, Controlled-Voltage applications, Series or Parallel amplifier systems can be configured using standard 7228 amplifiers and the following accessories available from AE Techron:  
**Series Systems: SIM2 Series Cable Kit** (part number 52-8004125)  
**Parallel Systems: SIM2 Parallel Cable Kit** (part number 52-8004164)

Please contact AE Techron's **Sales Department** for more information.

**6.2.1 Multiamp Safety Principles**

Following these basic principles will help to ensure the safety of your equipment and personnel.

**One Master Amplifier**

Typical multiamp configurations require one amplifier configured as a Master amplifier, and all other amplifiers in the system configured as Slave amplifiers. Do not operate with more than one Master in your multiamp system unless instructed by AE Techron Technical Support.

**Use Only 7228 Amplifiers**

Use only AE Techron 7228 amplifiers to construct a 7228 multiamp system. Do not combine different models of AE Techron amplifiers in the same system or use amplifiers made by another manufacturer in a 7228 multiamp system. Such improper connections could damage the amplifiers.

**Use Correct Wiring**

Never directly connect one amplifier's OUTPUT terminal to another amplifier's OUTPUT terminal. The resulting circulating currents will waste power

and may damage the amplifiers. Depending on the configuration to be used, the OUTPUT terminal of one amplifier should only be directly connected to the next amplifier's COM terminal or to the load.

**Operate with Safety in Mind**

Potentially lethal voltages and currents are present within the 7228 amplifiers. While the amplifiers' chassis are earth-grounded, **all internal grounds are floating**. Particularly in series systems, all internal grounds of **Slave amplifiers could carry lethal voltages**.



WARNING

ELECTRIC SHOCK HAZARD.

Output potentials can be lethal. Make connections only with AC Power OFF and input signals removed.

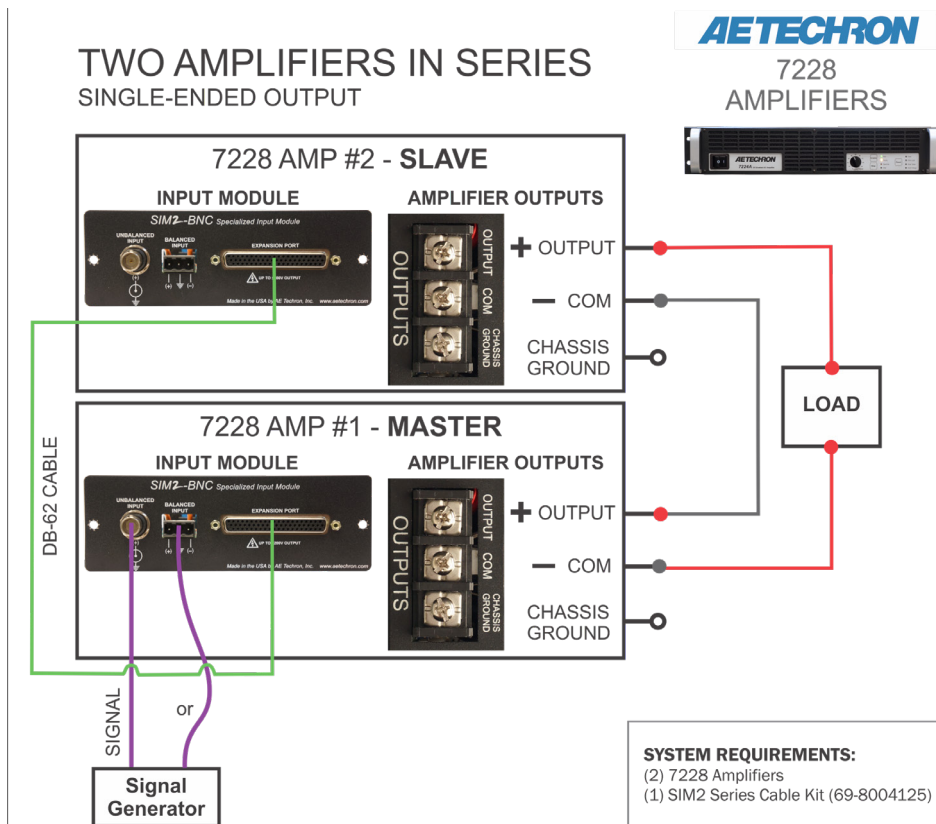

**6.2.2 Two in Series, Single-Ended Configuration**

To configure and connect two amplifiers for operation in a series configuration, begin by designating one amplifier as the Master amplifier, and the other amplifier as the Slave amplifier. Consider placing a “Master” or “Slave” label on each amplifier’s back panel to clarify the amplifier designation during setup and operation.

Make sure both amplifiers are disconnected from AC power.

**DIP Switch Settings**

On the amplifier designated as the Slave amplifier, make the following changes to the back-panel DIP switch settings:

**Set DIP switch #1 in the DOWN (Series Slave) position.**

**Amplifier Wiring**

Refer to **Figure 6.4** and make the following connections to the Master and Slave amplifiers.

1. Connect the **SIM2 Series Cable** (part number

69-8004125) from the back-panel Expansion Port on the Master amplifier to the Expansion Port on the Slave amplifier.

2. Connect from a signal generator to the BNC signal input connector on the Master amplifier’s back panel.
3. Using wiring appropriate for your application, connect from the Master amplifier’s back-panel OUTPUT connector to the Slave amplifier’s back-panel COM connector.
4. Using wiring appropriate for your application and your load, connect from the Slave amplifier’s OUTPUT connector to the load’s positive terminal.
5. Connect from the load’s negative terminal to the Master amplifier’s COM connector.

**6.2.3 Two in Parallel Configuration**

To configure and connect two amplifiers for operation in a parallel configuration, begin by designating one amplifier as the Master amplifier, and the other amplifier as the Slave amplifier. Consider placing a “Master” or “Slave” label on each ampli-

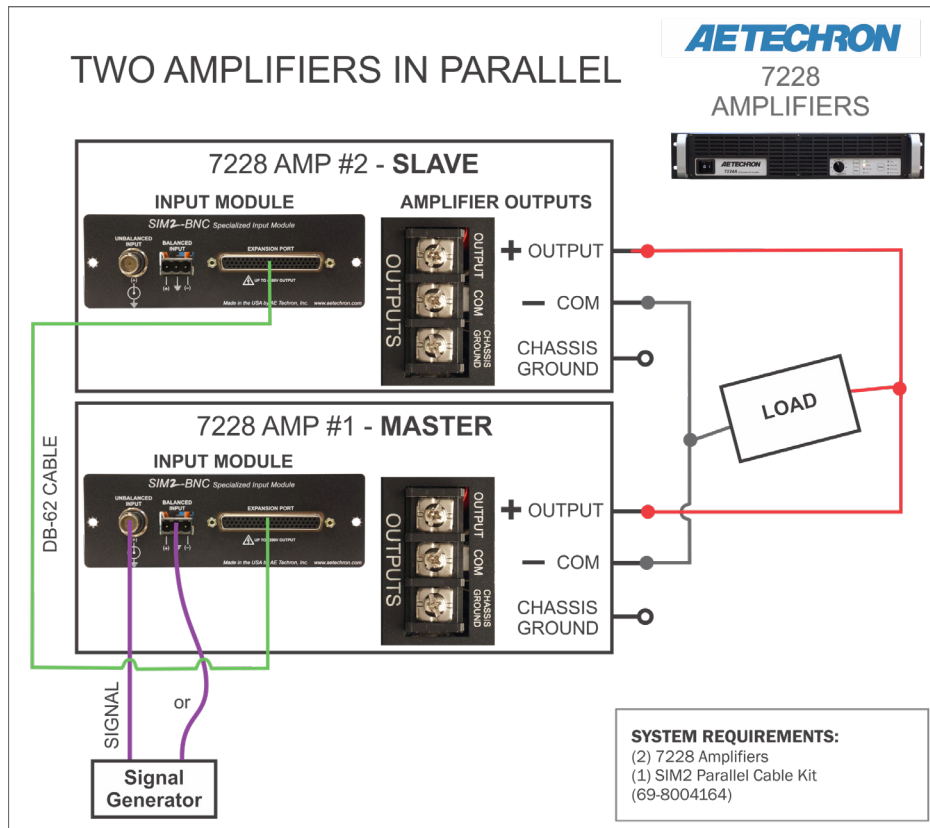

Figure 6.6 – Two Amplifiers in Parallel



fier's back panel to clarify the amplifier designation during setup and operation.

Make sure both amplifiers are disconnected from AC power.

### DIP Switch Settings

On the amplifier designated as the Slave amplifier, **set DIP switch #2 in the DOWN (Master Slave) position**

On both amplifiers, **set DIP switch #3 in the DOWN (Parallel Matching ON) position**

### Amplifier Wiring

Refer to **Figure 6.5** and make the following connections to the Master and Slave amplifiers.

1. Connect the DB-62 cable from the **SIM2 Parallel Kit** (part number 69-8004164) from the back-panel Expansion Port on the Master amplifier to the Expansion Port on the Slave amplifier.
2. Connect from a signal generator to the BNC signal input connector on the Master amplifier's back panel.
3. Using the red and black output cables from the **SIM2 Parallel Kit**, connect one cable leg of the black (ground) output cable to each of the amplifier's back-panel COM connectors, and then connect the cable's terminated end to the ground terminal of your load. Next, connect one cable leg of the red (positive) output cable to each of the amplifier's back-panel OUTPUT connectors, and then connect the cable's terminated end to the positive terminal of your load.

### 6.2.4 Multiamp System Start-up Procedure

1. Turn down the level of your signal source.
2. Make sure the Gain Control on both amplifiers is turned fully clockwise (100%).
3. Depress the POWER switches on both the Master and the Slave amplifiers (in any order) to turn the power ON.
4. Wait for the yellow READY and green RUN LEDs to illuminate on both amplifiers.
5. Adjust the input signal level to achieve the desired output level.

### 6.2.5 Multiamp System Operation

In multiamp systems, the Master amplifier controls several operating functions for all amplifiers included in the system, so Slave amplifiers are said to be "interlocked" with the Master amplifier. The functions controlled by the Master amplifier include input signal, operating status, mode of operation (controlled-voltage or controlled-current operation) and amplifier compensation.

Because the amplifiers in a multiamp system are interlocked, the main and fault status indicators of all amplifiers in the system must be considered to determine the current status and the necessary remedies to return the system to operational status when a fault condition occurs.

### Enable, Stop and Reset Buttons

The following details the results when each of the three Push Buttons are pressed on an amplifier front panel in a multi-amp system.

**Enable** – In multi-amp systems that have been configured to start up in Run mode (factory default setting), when an amplifier is powered on, the amplifier will be placed in Remote Standby mode (Ready and Standby LEDs lit) and remain in Remote Standby mode until all amplifiers in the system have been powered on. The system will automatically proceed to Run mode when all amplifiers in the system are powered on and achieve Remote Standby mode.

In multi-amp systems that have been configured to start up in Stop mode, when an amplifier is powered on, the amplifier will be placed in Standby/ Stop mode (Stop and Standby LEDs lit). When the Enable button is pressed on each amplifier, that amplifier will be placed in Remote Standby mode (Ready and Standby LEDs lit) and remain in Remote Standby mode until all amplifiers in the system have been Enabled. The system will automatically proceed to Run mode when all amplifiers in the system achieve Remote Standby mode.

**Stop** – Pressing the Stop button on any amplifier in the system will place that amplifier in Standby/

Stop mode and place all other amplifiers in the system in Remote Standby mode.

**Reset** – Pressing the Reset button on the amplifier reporting a fault condition will return all of the amplifiers to Run mode if the condition causing the fault condition has been cleared and the amplifier has been configured for startup in Run mode. However, pressing the Reset button on other amplifiers in the system (not reporting a fault condition) will NOT clear the fault condition. Refer to the **“Fault Status Indicators”** section for information on how to clear fault conditions and restore amplifier operation.

If the amplifier reporting the fault condition has been configured for startup in Stop mode, pressing the Reset button will place the amplifier in Standby/Stop mode. Press the Enable button to return the amplifier system to Run mode.

### **Main Status Indicators for Multi-amplifier Systems**

The Main Status indicators on each amplifier in a multi-amp system are used to determine the

operational status of the amplifier. When evaluated along with the statuses of other amplifiers in the system, the Main Status indicators can be used to determine the system status and the action required to return the system to Run mode. See **Figure 6.6**.

### **Fault Status Indicators for Multi-Amp Systems**

The four Fault Status indicators located on each amplifier's front panel are used to monitor the internal conditions of the amplifier and will illuminate when a fault condition occurs. All amplifiers in the system may be placed in Standby mode when a fault condition occurs, depending on the fault condition and the configuration of the system. Typically, the system can be released from Standby mode by pressing the Reset button on the amplifier displaying the Fault status. Refer to the chart in **Figure 6.7** to determine the fault condition being indicated and the action required to clear the fault condition and return the system to Run mode.

**Figure 6.6 – Main Status Indicators for Multi-Amplifier Systems**

● ● ● Indicator is lit   ● Indicator is not lit   ○ Indicator may be lit

Main Status of One or More Amps in the System	Main Status of Other Amps in the System	State of Operation	Action Needed to Return to Run Mode
<ul style="list-style-type: none"> <li>● Run</li> <li>● Ready</li> <li>● Standby</li> <li>● Stop</li> </ul>	<ul style="list-style-type: none"> <li>● Run</li> <li>● Ready</li> <li>● Standby</li> <li>● Stop</li> </ul>	<p><b>Run mode:</b> All of the amplifiers in the system are in Run mode. The amplifiers' high-voltage transformers are energized and the system will amplify the input signal.</p>	N/A
<ul style="list-style-type: none"> <li>● Run</li> <li>● Ready</li> <li>● Standby</li> <li>● Stop</li> </ul>	<ul style="list-style-type: none"> <li>● Run</li> <li>● Ready</li> <li>● Standby</li> <li>● Stop</li> </ul>	<p><b>Standby mode:</b> Standby mode indicates that the amplifier has been placed in Standby because: 1) Ground loop and/or circulating currents have triggered the ground-loop protection circuit; or 2) Some combinations of DIP switches have been set improperly. In Standby mode, the amplifier's low-voltage transformer is energized but the high-voltage transformers are not.</p>	<p>Check to see if one of the following improper DIP switch combinations has been set: <b>#6 UP</b> and <b>#11 DOWN</b>, or <b>#13 - #16 all DOWN</b>. To release the amplifier from Standby mode, change the improper setting and the amplifier will automatically return to Run mode. If the switches are set properly but the amp remains in Standby, eliminate ground loop conditions and the amp will automatically return to Run mode.</p>
<ul style="list-style-type: none"> <li>● Run</li> <li>● Ready</li> <li>● Standby</li> <li>● Stop</li> </ul>	<ul style="list-style-type: none"> <li>● Run</li> <li>● Ready</li> <li>● Standby</li> <li>● Stop</li> </ul>	<p><b>Remote Standby mode:</b> All of the amplifiers in the system are being held in Standby mode by an external condition. In Standby mode, the amplifiers' low-voltage transformers are energized but the high-voltage transformers are not.</p>	<p>If the amplifiers remain in Standby mode, the system is being held in Standby by remote control through the Expansion Port. Activate the Standby switch to clear this remote Standby condition and return the system to Run mode. See the topic <i>"Remote Status, Configuration and Control"</i> in the <b>Applications</b> section of this manual for more information on remote amplifier operation.</p>
<ul style="list-style-type: none"> <li>● Run</li> <li>● Ready</li> <li>● Standby</li> <li>● Stop</li> </ul>	<ul style="list-style-type: none"> <li>● Run</li> <li>● Ready</li> <li>● Standby</li> <li>● Stop</li> </ul>	<p><b>System Not Ready:</b> If one or more of the amplifiers has no LEDs lit, the amplifier has no power or has not been turned on, and the other amplifiers in the system will be held in Remote Standby mode. In Remote Standby mode, the amplifier's low-voltage transformer is energized but the high-voltage transformers are not.</p>	<p>Make sure all amplifiers have AC power and have been turned on. When all amplifiers attain Standby status, all amplifiers in the system will simultaneously be placed in Run mode.</p>
<ul style="list-style-type: none"> <li>● Run</li> <li>● Ready</li> <li>● Standby</li> <li>● Stop</li> </ul>	<ul style="list-style-type: none"> <li>● Run</li> <li>● Ready</li> <li>● Standby</li> <li>● Stop</li> </ul>	<p><b>Standby/Stop mode:</b> When the Stop button on any amplifier in the system is pressed, that amplifier will enter Stop mode and all other amplifiers will enter Remote Standby mode. The system may also enter Stop mode after powering up if one or more amplifiers in the system is configured to enter Stop mode on startup. In Stop mode, the amplifier's low-voltage transformer is energized but the high-voltage transformers are not.</p>	<p>To release the system from Standby/Stop mode, press the Enable button on the amplifier displaying the Stop mode status. If the amplifier will not release from Standby/Stop mode, check to see if both DIP switches <b>#1</b> and <b>#2</b> are in the <b>DOWN</b> position. Place one or both switches in the <b>UP</b> position, and then press the Enable button to release the amplifier from Standby/Stop mode.</p>

**Figure 6.7 – Fault Status Indicators for Multi-Amplifier Systems**

● ● ● Indicator is lit    ● Indicator is not lit    ○ Indicator may be lit

One or More Amps in System		Other Amps in System		State of Operation	Action Needed to Clear Fault Condition and Return to Run Mode
Main Status Indicators	Fault Status Indicators	Main Status Indicators	Fault Status Indicators		
<ul style="list-style-type: none"> <li>● Run</li> <li>● Ready</li> <li>● Standby</li> <li>● Stop</li> </ul>	<ul style="list-style-type: none"> <li>● Fault</li> <li>● Over Load</li> <li>● Over Temp</li> <li>● Over Voltage</li> </ul>	<ul style="list-style-type: none"> <li>● Run</li> <li>● Ready</li> <li>● Standby</li> <li>● Stop</li> </ul>	<ul style="list-style-type: none"> <li>● Fault</li> <li>● Over Load</li> <li>● Over Temp</li> <li>● Over Voltage</li> </ul>	<p><b>Output Fault status:</b> This indicates that an Output Fault condition has occurred in the amplifier displaying the Fault status, and the system has been placed in Standby mode. The Fault indicator will light under two conditions: 1) High-frequency oscillation is causing high shoot-through current; or 2) An output transistor has shorted, causing the output fault condition.</p>	<p>This fault condition cannot be cleared using the front-panel Reset button. See the “<b>Troubleshooting</b>” section for more information on diagnosing and clearing this fault condition.</p>
<ul style="list-style-type: none"> <li>● Run</li> <li>● Ready</li> <li>○ Standby</li> <li>● Stop</li> </ul>	<ul style="list-style-type: none"> <li>● Fault</li> <li>● Over Load</li> <li>● Over Temp</li> <li>● Over Voltage</li> </ul>	<ul style="list-style-type: none"> <li>● Run</li> <li>○ Ready</li> <li>○ Standby</li> <li>● Stop</li> </ul>	<ul style="list-style-type: none"> <li>● Fault</li> <li>● Over Load</li> <li>● Over Temp</li> <li>● Over Voltage</li> </ul>	<p><b>Over Load status:</b> This indicates that the output of the system could not follow the input signal due to voltage or current limits. Under normal operation with the factory-default settings, an Over Load condition will not place the system in Standby mode. If the system has been configured to be forced to Standby on Over Load, the system will be placed in Standby mode when the Over Load indicator lights.</p>	<p>To remedy the Over Load fault during operation, turn down the level of the input signal until the Over Load indicator turns off. To clear an Over Load fault condition when the amplifier is forced to Standby, turn down the level of the input signal, then push the Reset button on the amplifier(s) displaying the Over Load status.</p>

*(continued on next page)*

One or More Amps in System		Other Amps in System		State of Operation	Action Needed to Clear Fault Condition and Return to Run Mode
Main Status Indicators	Fault Status Indicators	Main Status Indicators	Fault Status Indicators		
<ul style="list-style-type: none"> <li>● Run</li> <li>● Ready</li> <li>● Standby</li> <li>● Stop</li> </ul>	<ul style="list-style-type: none"> <li>● Fault</li> <li>● Over Load</li> <li>○ Over Temp</li> <li>● Over Voltage</li> </ul>	<ul style="list-style-type: none"> <li>● Run</li> <li>● Ready</li> <li>● Standby</li> <li>● Stop</li> </ul>	<ul style="list-style-type: none"> <li>● Fault</li> <li>● Over Load</li> <li>● Over Temp</li> <li>● Over Voltage</li> </ul>	<p><b>Over Temp status:</b> Each amplifier in the system monitors the temperature inside the high-voltage transformers, low-voltage transformer and in the output stage heat sinks. The Over Temp indicator will light and the system will be placed in Standby mode when the temperature sensors detect a condition that would damage the amplifier system. If the Over Temp pulse is extremely short, as in the case of defective wiring or switches, the Over Temp LED may be lit too briefly to observe.</p>	<p>To reset after an Over Temp fault has occurred, make sure the amplifier fans in all amplifiers are running, and then remove the input signal from the system. Note that the fans will automatically switch to high-speed operation on an Over Temp condition. Allow the fans to run for about 5 minutes, or until the fans switch to low-speed operation (fans will not move to low-speed operation if they have been configured for continuous high-speed operation). Push and hold the Reset button on any amplifier displaying the Over Temp status until the Standby LED turns off, then release the Reset button to return the system to Run mode. Please see the <b>Troubleshooting</b> section for information on correcting the cause of an Over Temp fault condition.</p>
<ul style="list-style-type: none"> <li>● Run</li> <li>● Ready</li> <li>● Standby</li> <li>● Stop</li> </ul>	<ul style="list-style-type: none"> <li>● Fault</li> <li>● Over Load</li> <li>● Over Temp</li> <li>● Over Voltage</li> </ul>	<ul style="list-style-type: none"> <li>● Run</li> <li>● Ready</li> <li>● Standby</li> <li>● Stop</li> </ul>	<ul style="list-style-type: none"> <li>● Fault</li> <li>● Over Load</li> <li>● Over Temp</li> <li>● Over Voltage</li> </ul>	<p><b>Over Voltage status:</b> This indicates that the AC mains voltage is more than +10% of nominal. All amplifiers in the system will be forced to Standby when an Over Voltage condition occurs. When the Over Voltage condition is cleared, the system will automatically return to Run mode.</p>	<p>To clear an Over Voltage fault condition, the AC mains must be brought down to the nominal value. If the system does not return to Run mode when the Over Voltage condition has cleared, one or more amplifiers may require servicing. Please see the <b>Troubleshooting</b> section for more information.</p>

### 6.3 DB-62 Expansion Port Applications

AE Techron 7228 amplifiers come with a SIM2-BNC input module that also contains a female, 62-pin D-Sub connector labeled as the Expansion Port. The Expansion Port is used to provide the amplifier interconnect for multi-amplifier applications and also can be used to provide remote configuration, control and monitoring of the amplifier.

#### 6.3.1 Expansion Port Accessories

AE Techron offers three accessories to be used with the Expansion Port to aid in these extended applications.

#### DB-62 Multi-amp Cables

The Series cable (part number 69-8004125) and Parallel cable kit (part number 69-8004164) contain 36-inch Expansion Port cables that can be used for amplifier interlock and signal sharing for Two-in-Series or Two-in-Parallel multiamp applications. For installation instructions, refer to the topic “Multiamp Systems for Increased Voltage or Current.”

### SIM2 Breakout Accessory

All amplifier configurations that can be performed using the back-panel DIP switches, as well as all status conditions reported by the amplifier’s front-panel LEDs, can also be performed remotely using the Expansion Port and the SIM2 Breakout Accessory (part number 69-8004155) (see **Figure 6.9**).

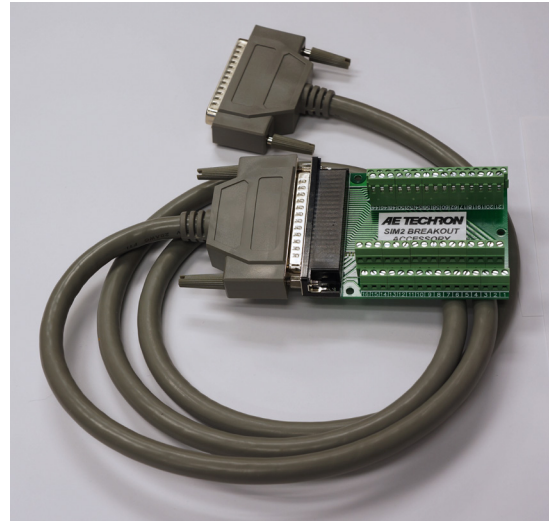

Figure 6.9 – SIM2 Breakout Accessory

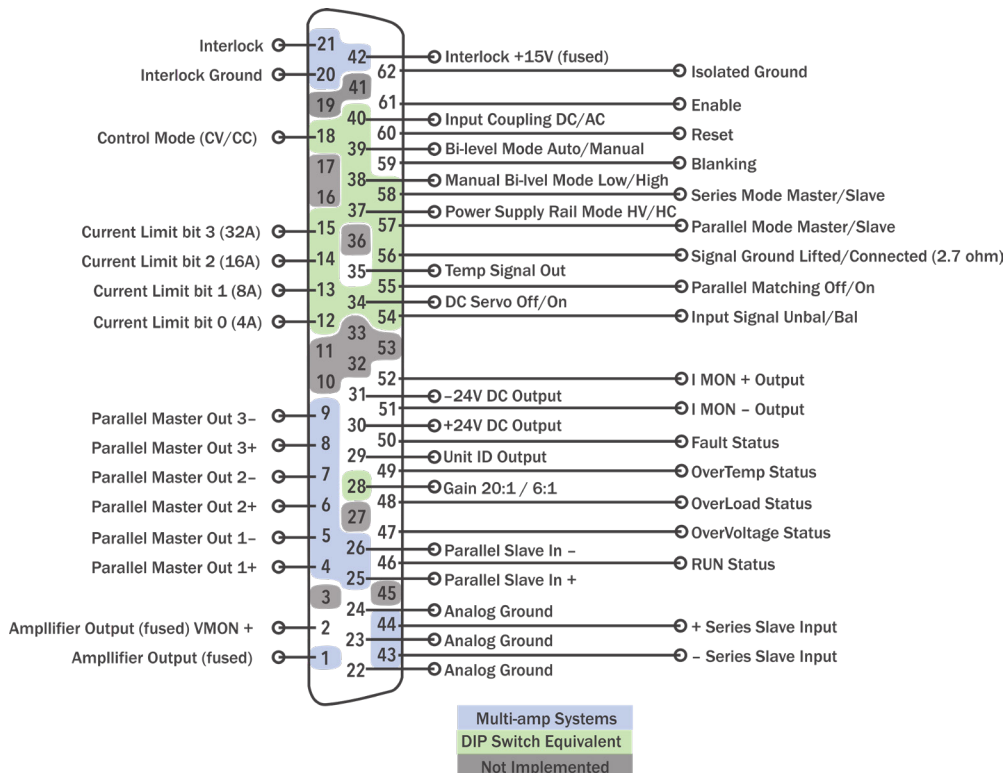

Figure 6.10 – Expansion Port Pinouts



In addition, control functions such as Blanking, Reset and Enable from Standby can be performed remotely using the Expansion Port and the SIM2 Breakout Accessory.

Refer to **Figure 6.10** for a quick reference of the Expansion Port pinouts. A detailed chart of all Expansion Port pinouts and suggested applications is provided in **Appendix 1**.

**6.3.2 SIM2 Breakout Accessory Applications**

The following suggested applications show some of the possible uses of the SIM2 Breakout Accessory. Note that the procedures outlined in this section assume competence on the part of the reader in terms of amplifier systems, electronic components, and good electronic safety and working practices.

**REMOTE AMPLIFIER STATUS**

The SIM2 Breakout Accessory can be used to create a circuit to monitor remotely one or more amplifier conditions, including Run status, Fault, Over-temperature, Overload and Overvoltage.

Use T-1 LEDs and high-quality wire to build the circuit. **Figure 6.11** details the circuit required for all status functions.

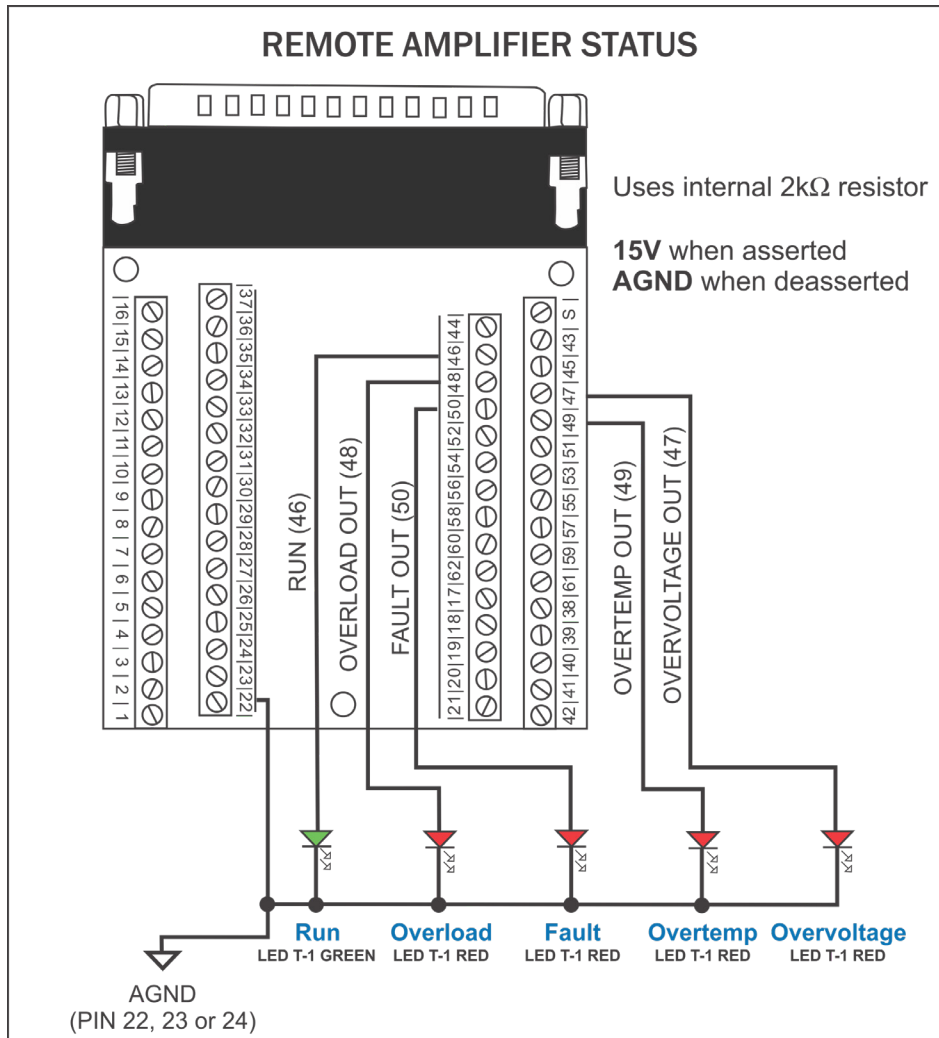

Figure 6.11 – Remote Amplifier Status



**Remote Signal of Run Condition**

**Purpose:** LED, when lit, signals a Run state.

**Method:** Tie Run (PIN 46) to Analog Ground (PIN 22, 23 or 24).

**Signal Type:** DC

**Level when Asserted:** 15V

**Level when Deasserted:** 0V

**Note:** When the amplifier is in a Run state, the level is asserted and the output is tied to 15V through a 2k ohm resistor. When the amplifier is in Standby, the output level is at 0V (Analog Ground). The output is limited to 7mA. Reference is to the Analog Ground (Pin 22, 23 or 24).

**Remote Signal of Over Load Condition**

**Purpose:** LED, when lit, signals an over load condition.

**Method:** Tie Over Load Output (PIN 48) to Analog Ground (PIN 22, 23 or 24).

**Signal Type:** DC

**Level when Asserted:** 15V

**Level when Deasserted:** 0V

**Note:** When the amplifier is in an over load state, the level is asserted and the output is tied to 15V through a 2k ohm resistor. When the amplifier is in normal, operation, the output level is at 0V (Analog Ground). The output is limited to 7mA. Reference is to the Analog Ground (Pin 22, 23 or 24).

An over load condition will not place the amplifier in Standby when operating with the factory default settings. In order to clear the fault condition, reduce the input levels until the Over Load LED turns off. However, if the Standby Mode on Over Load option is set, an over load condition will force amp to Standby. To return the amplifier to Run mode, reduce the input signal level, then trigger a Reset command using the front-panel Reset button or a remote amplifier Reset command.

**Remote Signal of Fault Condition**

**Purpose:** LED, when lit, signals a Fault condition.

**Method:** Tie Amp Fault Output (PIN 50) to Analog Ground (PIN 22, 23 or 24).

**Signal Type:** DC

**Level when Asserted:** 15V

**Level when Deasserted:** 0V

**Note:** This indicates that an output fault condition has occurred and the amplifier has been placed in Standby mode. The Fault indicator will light under two conditions: 1) High-frequency oscillation is causing high shoot-through current; or 2) An output transistor has shorted, causing the output fault condition.

This fault condition cannot be cleared using the front-panel Reset button or a remote amplifier Re-

set command. See the “**Troubleshooting**” section for more information on diagnosing and clearing this fault condition.

**Remote Signal of Over Temp Condition**

**Purpose:** LED, when lit, signals an over temperature condition.

**Method:** Tie Over Temp Output (PIN 49) to Analog Ground (PIN 22, 23 or 24).

**Signal Type:** DC

**Level when Asserted:** 15V

**Level when Deasserted:** 0V

**Note:** When the amplifier is in an over temperature state, the level is asserted and the output is tied to 15V through a 2k ohm resistor. When the amplifier is in normal, operation, the output level is at 0V (Analog Ground). The output is limited to 7mA. Reference is to the Analog Ground (Pin 22, 23 or 24).

An over temperature condition will force the amp to Standby. To reset after an Over Temp fault has occurred, make sure the fans are running, and then remove the input signal from the amplifier. Note that the fans will automatically switch to high-speed operation on an over temperature condition. Allow the fans to run for about 5 minutes, or until the fans switch to low-speed operation (fans will not move to low-speed operation if they have been configured for continuous high-speed operation). Push and hold the Reset button until the Standby LED turns off, and then release the Reset button to return the system to Run mode. See the **Troubleshooting** section for information on correcting the cause of an Over Temp fault condition.

**Remote Signal of Over Voltage Condition**

**Purpose:** LED, when lit, signals an over voltage condition.

**Method:** Tie Over Voltage Output (PIN 47) to Analog Ground (PIN 22, 23 or 24).

**Signal Type:** DC

**Level when Asserted:** 15V

**Level when Deasserted:** 0V

**Note:** When the amplifier is in an over voltage state, the level is asserted and the output is tied to 15V through a 2k ohm resistor. When the amplifier is in normal, operation, the output level is at 0V (Analog Ground). The output is limited to 7mA. Reference is to the Analog Ground (Pin 22, 23 or 24).

To clear an Over Voltage fault condition, the AC mains must be brought down to the nominal value. Once the over voltage condition has been cleared, press the Reset button to return the amplifier to Run mode. If the amplifier does not return to Run mode, the amplifier may require servicing. Please see the **Troubleshooting** section for more information.

**REMOTE VOLTAGE OUTPUT MONITOR**

The SIM2 Breakout Accessory can be used to monitor remotely the voltage output of the amplifier. See **Figure 6.12**.

**Purpose:** Use a voltage meter to monitor output voltage.

**Method:** Connect a voltage meter to monitor the output voltage being produced by the amplifier. Connect across PIN 2 (Amp Out) and PIN 22,23 or 24 (Analog Ground). Do not connect to any impedance of less than 10k ohm. NOTE: Output is fused.

**Signal Type:** AC or DC

**Level:** Can be greater than  $\pm 200V$  peak.

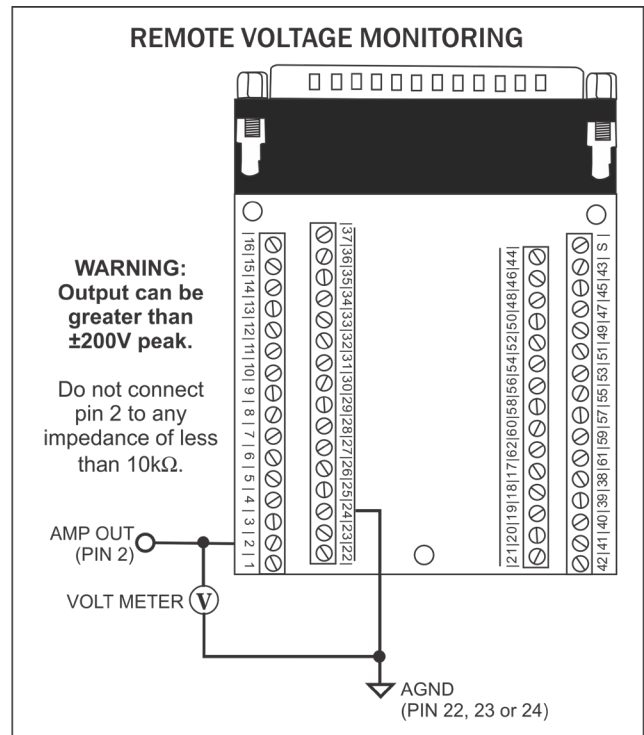

Figure 6.12 – Remote Voltage Output Monitor

**REMOTE CURRENT MONITOR**

The SIM2 Breakout Accessory can be used to monitor remotely the current output of the amplifier. See **Figure 6.13**.

**Purpose:** Use a voltage meter to monitor output current.

**Method:** Connect a voltage meter to monitor the output current being produced by the amplifier. Connect across PIN 52 (I MON+ Output) and PIN 22,23 or 24 (Analog Ground). For each 1V detected, current output is 5A.

**Signal Type:** AC or DC

**Level:** 5A/V.

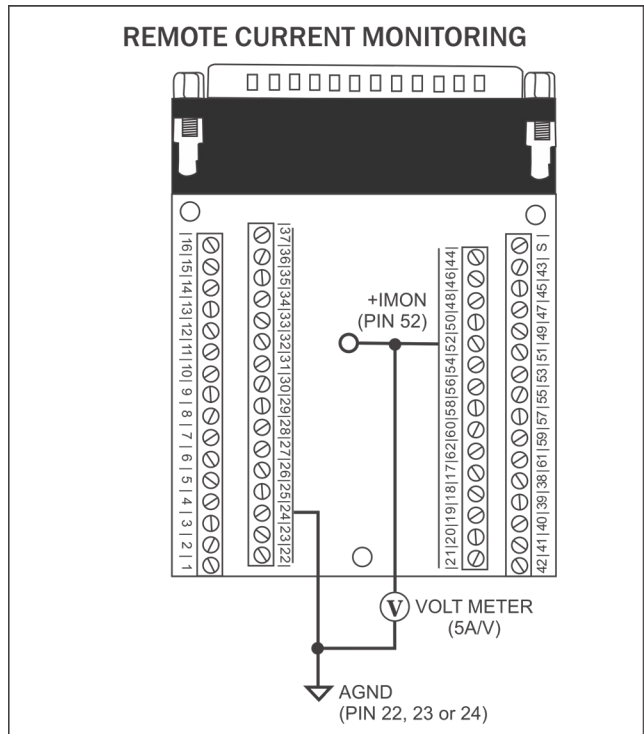

Figure 6.13 – Remote Current Monitor

**REMOTE CURRENT MONITOR, DIFFERENTIAL METHOD**

The SIM2 Breakout Accessory can be used to monitor remotely the current output of the amplifier when the output is not balanced. See **Figure 6.14**.

**Purpose:** Use a voltage meter to monitor output current.

**Method:** Connect a voltage meter to monitor the output current being produced by the amplifier. Connect across PIN 52 (I MON+ Output) and PIN 51 (I MON- Output). For each 1V detected, current output is 2.5A.

**Signal Type:** AC or DC

**Level:** 2.5A/V.

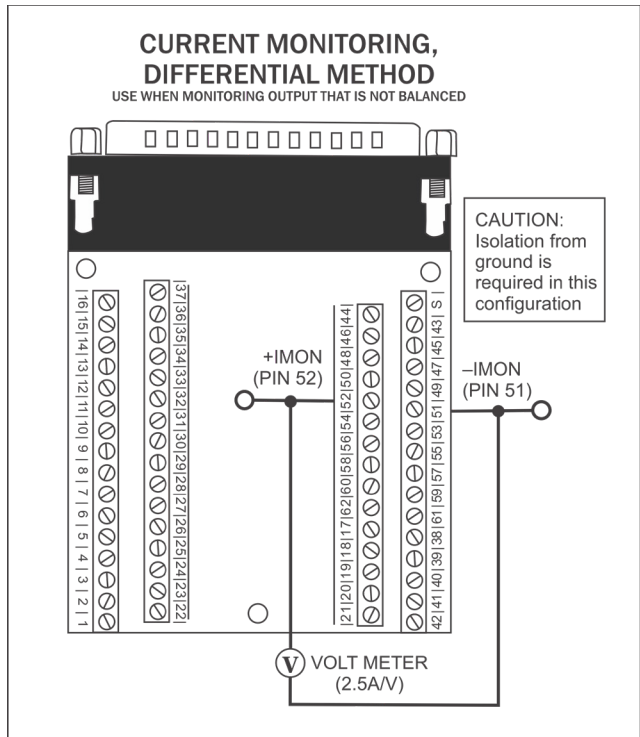

Figure 6.14 – Remote Current Monitor, Differential Method

**REMOTE TEMPERATURE MONITOR**

The SIM2 Breakout Accessory can be used to monitor remotely the internal temperature of the amplifier. The temperatures of +VCC heatsink and -VCC heatsink are compared and the higher value is reported to Temp Signal Out. See **Figure 6.15**.

**Purpose:** Use a voltage meter to monitor the amplifier's internal temperature.

**Method:** Connect a voltage meter to monitor the voltage of Temp Signal Out. Connect across PIN 35 (Temp Signal Out) and PIN 22, 23, or 24 (Analog Ground). Voltage output is equal to the highest heatsink temperature in degrees Kelvin (1V = 100°K). Convert to Fahrenheit ( $^{\circ}\text{F} = 1.8 \times (^{\circ}\text{K} - 273) + 32$ ); Convert to Celsius ( $^{\circ}\text{C} = ^{\circ}\text{K} - 273$ ).

**Signal Type:** DC

**Level:** 2.93V to 3.73V.

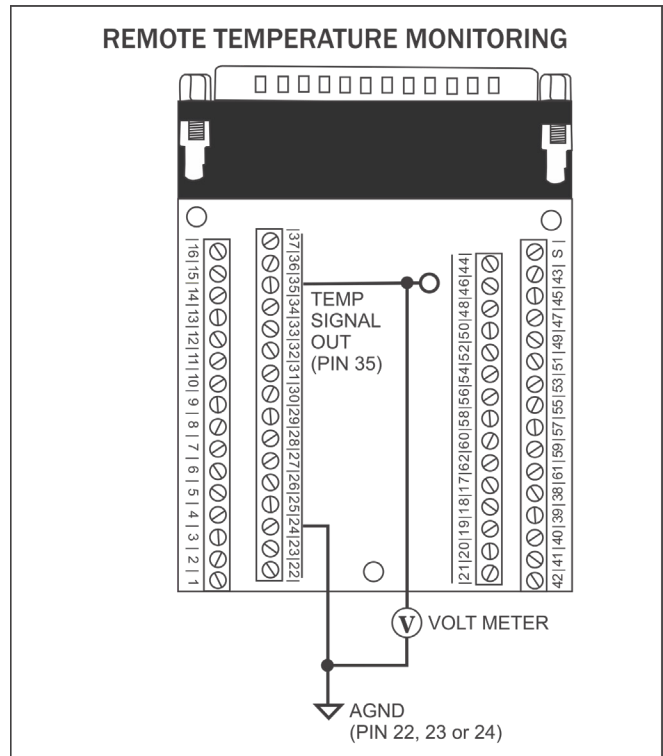

Figure 6.15 – Remote Temperature Monitor

**REMOTE STANDBY/ENABLE/INTERLOCK**

The SIM2 Breakout Accessory can be used to remotely place the amplifier in Standby mode and return the amplifier to Run mode. See **Figure 6.16**.

**Purpose:** Use a switch or optocoupler to remotely disable the amplifier and place it in Standby mode. Also, return the amplifier from Standby mode to the Run condition.

**Method:** Short PIN 21 of amplifier to Interlock Ground (PIN 20) using a dry contact switch or optocoupler. When Interlock (PIN 21) is shorted to Interlock Ground (PIN 20), amplifier is placed in Standby mode. When switch is open, amplifier is released to the Run condition.

**Signal Type:** DC

**Level when Asserted:** 0 V

**Level when Deasserted:** open

**IMPORTANT:** The amplifier must be configured for Ready mode at startup (factory default) or the Run button must be pressed at the amplifier front panel at startup. The Remote Enable/Standby circuit will not function if the Startup to Standby Latch has been activated on the amplifier.

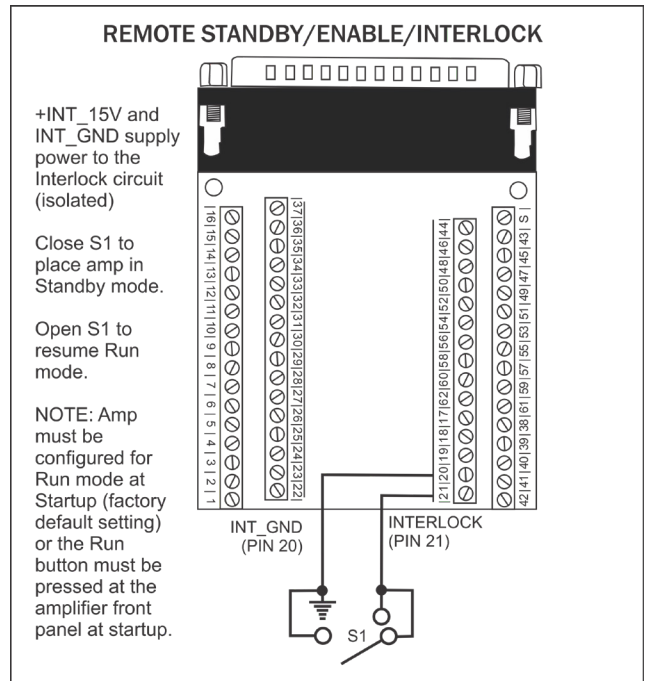

Figure 6.16 – Remote Standby/Enable/Interlock

**REMOTE RESET/ENABLE/BLANKING**

The SIM2 Breakout Accessory can be used to remotely mute the amplifier, release from Standby mode, and Reset the amplifier after a fault condition has occurred. See **Figure 6.17**.

**Blanking Control**

**Purpose:** Use switch or optocoupler to remotely mute the amplifier.

**Method:** Assert 5-15VDC between ISO-GND (PIN 62) and BLANKING INPUT (PIN 59) to activate the blanking feature.

**Signal Type:** DC

**Level when Asserted:** 5 - 15V

**Level when Deasserted:** 0V

**Note:** Amplifier output is muted when asserted. Normal amplifier operation when deasserted.

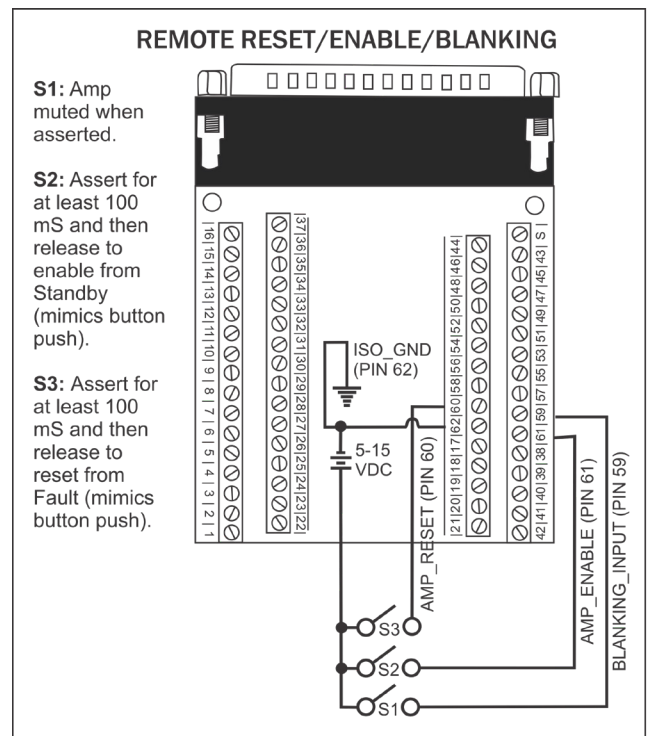

Figure 6.17 – Remote Reset/Enable/Blanking

**Reset after Fault**

**Purpose:** Reset the amplifier after a fault condition has occurred.

**Method:** Assert 5-15VDC between ISO-GND (PIN 62) and AMP RESET (PIN 60) for at least 100 mS and then release to reset from fault (mimics button push).

**Signal Type:** DC

**Level when Asserted:** 5 - 15V

**Level when Deasserted:** 0V

**Note:** The fault condition must be cleared before the amplifier can be reset. When the amplifier is reset from a fault condition, it will return to Standby or Run mode, depending on the mode it was in when the fault condition occurred.

**Enable from Standby**

**Purpose:** Release the amplifier from Standby mode and return the amplifier to Run mode.

**Method:** Assert 5-15VDC between ISO-GND (PIN 62) and AMP ENABLE (PIN 61) for at least 100 mS and then release to enable from Standby (mimics button push).

**Signal Type:** DC

**Level when Asserted:** 5 - 15V

**Level when Deasserted:** 0V

**REMOTE DIP SWITCH CONTROL**

The SIM2 Breakout Accessory can be used to remotely control all functions available through the amplifier's back-panel DIP switches. See **Figure 6.18**. A sample application showing wiring for four DIP switch functions is shown in **Figure 6.19** and detailed below.

**Remote DIP Switch Sample Application**

**Purpose:** Use switches or optocouplers to remotely control the amplifier's Power Supply Rail mode, Bi-level mode, Bi-Level Manual setting and Control Mode setting.

**Method:** Assert 5-15VDC between ISO-GND (PIN 62) and CONTROL MODE (PIN 18), POWER SUPPLY RAIL MODE (PIN 37), MANUAL BI-LEVEL MODE (PIN 38), or BI-LEVEL MODE (PIN 39) to activate the non-default option.

**Signal Type:** DC

**Level when Asserted:** 5 - 15V

**Level when Deasserted:** 0V

**IMPORTANT:** The amplifier's DIP switches must be in the default position (UP) to allow remote DIP switch control.

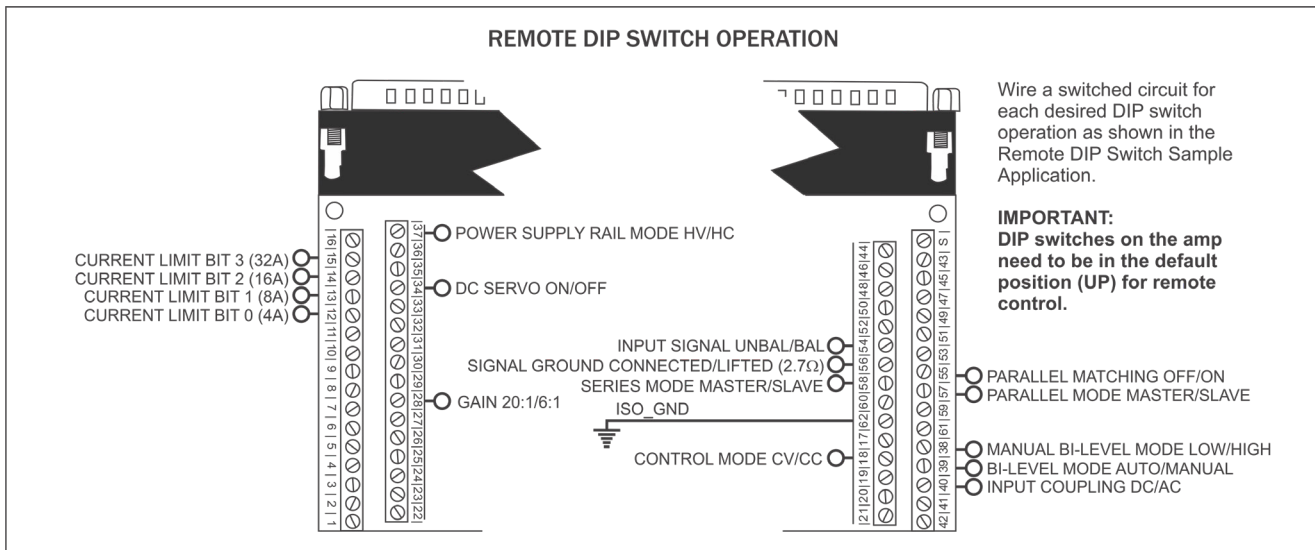

Figure 6.18 – All DIP switch functions can be controlled remotely using the SIM2 Breakout Accessory



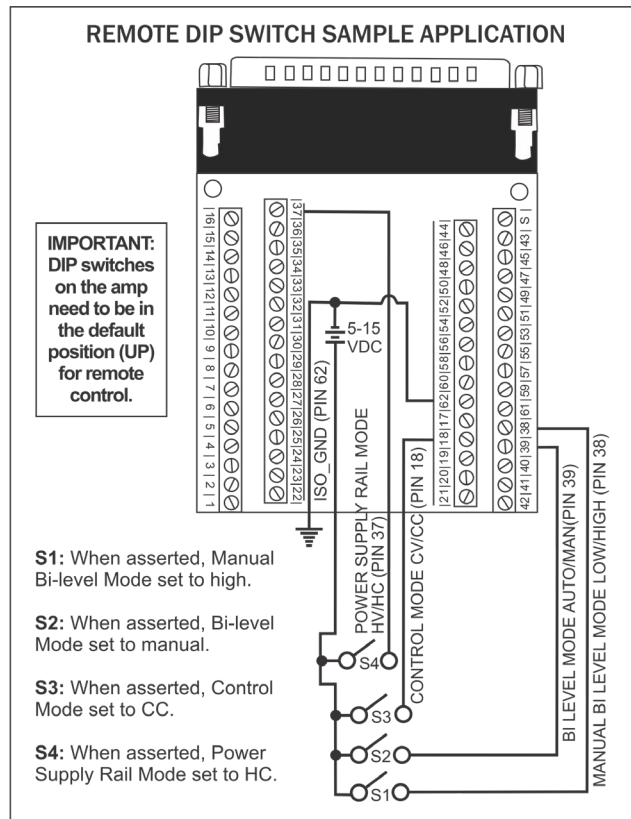

Figure 6.19 – Remote DIP Switch Control Sample Application

## 6.4 Controlled Current Operation

The procedures outlined in this section assume competence on the part of the reader in terms of amplifier systems, electronic components, and good electronic safety and working practices.

### 6.4.1 Controlled-Voltage vs. Controlled-Current Modes of Operation

AE Techron 7228 amplifiers can be field-configured to operate as **Voltage Amplifiers** (Voltage-Controlled Voltage Source) or as **Transconductance Amplifiers** (Voltage-Controlled Current Source). The mode selection is made via jumpers on the amplifier's UFEB board. See the **Advanced Configuration** section for more information.

When configured as a **Controlled-Voltage** source (voltage amplifier), the amplifier will provide an output voltage that is constant and proportional to the control (input) voltage. If the load's impedance changes, the amplifier will seek to maintain this ratio of input to output voltage by increasing or

decreasing the current it produces, as long as it is within the amplifier's ability to create the required current. Use this mode if you want the output voltage waveform to be like the input waveform (see **Figure 6.20**).

Conversely, when configured as a **Controlled-Current** source (transconductance amplifier), the amplifier will provide an output current that is constant and proportional to the control (input) voltage. If the load's impedance changes, the amplifier will seek to maintain this transconductance (ratio of input voltage to output current) by increasing or decreasing the voltage it produces, as long as it is within the amplifier's ability to create the required voltage. Use this mode if you want the output current waveform to be like the input waveform (see **Figure 6.21**).

### 6.4.2 Safety and Operation Considerations for Controlled Current Operation

When an AE Techron amplifier is configured as a Controlled-Current source, care needs to be exercised in its operation. **Any voltage controlled current source should never be turned on without a load, (with some impedance, real or effective) connected to its output terminals.**

When asked to operate in this way, any current source (including an AE Techron amplifier) will increase its output voltage in an attempt to drive the requested current into the load. In an open-circuit condition, creating current flow will be impossible. The current source will increase its output voltage until it reaches its voltage limit. This is a potentially dangerous condition for both the AE Techron amplifier and for any user who might come in contact with the amplifier output terminals.

When operating in Controlled-Current (CC) mode, a compensation circuit is required to ensure accurate output current. Since the load is a critical circuit component in CC mode, the inductive and resistive values of the load will determine the required compensation values. While the factory-default compensation setting will be sufficient for some applications, the compensation setting may also be adjusted in the field. The following section describes methods for determining and setting proper compensation when operating in Controlled-Current mode.

### 6.4.3 Controlling Compensation for CC Operation

AE Techron 7228 amplifiers can be configured for either Controlled Voltage (CV) or Controlled Cur-

#### CONTROLLED-VOLTAGE MODE

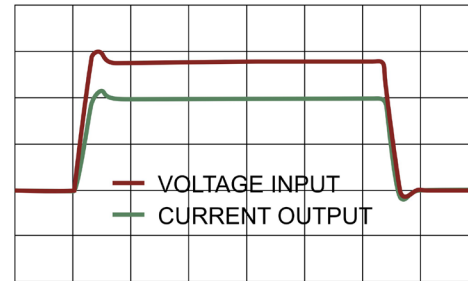

Figure 6.20 – Input to Output Comparison, Controlled-Voltage Operation

#### CONTROLLED-CURRENT MODE

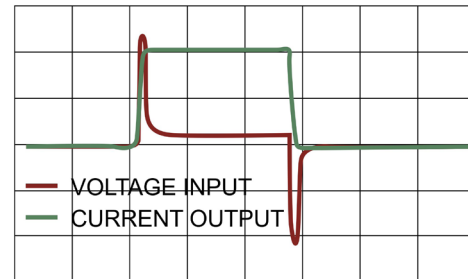

Figure 6.21 – Input to Output Comparison, Controlled-Current Operation

rent (CC) mode of operation. When operating the amplifier in Controlled Voltage (CV) mode, compensation is not required. However, when operating in Controlled Current (CC) mode, the amplifier load becomes an integral part of the system. In order to ensure system stability and to control available bandwidth, compensation via an RC network is required for CC operation. The following steps will allow you to compensate your amplifier for operation in CC mode safely and effectively.

#### STEP 1: Check Amplifier Operation in CV mode.

We recommend that you power-up and enable the amplifier in Controlled Voltage mode without attaching a load before configuring your amplifier for Controlled Current operation. This will allow you to verify that the input signal and the amplifier are operating correctly.

Once this initial check is completed, power down the amplifier, attach your load, and move the back-panel Controlled Mode DIP switch (SW#7) to the DOWN position to place the amplifier in CC mode. (Refer to the **Advanced Configuration** section for more information.)

**STEP 2: Determine Required Compensation.**

When operating an amplifier in Controlled-Current mode, the load becomes an integral part of the system. In order to determine the required compensation for your load, begin by consulting the following table to determine the approximate

compensation capacitance (C) required based on the inductance of your load. Note that these calculations are based on empirical measurements and are approximate.

Compensation Capacitance (CC)	Load Inductance (L)		
	<200 $\mu$ H	<>200 $\mu$ H – <1 mH	>1 mH
	0.001 $\mu$ F	0.01 $\mu$ F	0.1 $\mu$ F

**NOTE: Load Resistance (R) is assumed to be <5 ohms.**

**STEP 3: Determine if Default or Custom Compensation is Required.**

If your load inductance is between 200 microHenries and 1 milliHenry, and your load resistance is less than 5 ohms, then you can likely use the default compensation provided by the amplifier's factory-installed RC network (see Figure 6.22). This compensation network is enabled by default when the Current setting is selected on the Controlled Mode DIP switch.

If your load inductance falls outside of the mid-range, or if your load resistance is greater than 5 ohms, then you must calculate your required compensation. If, after calculating your required compensation, you determine that the default compen-

sation will be insufficient for your load, then you will need to calculate and then enable and install a custom RC network. See **STEP 5** below.

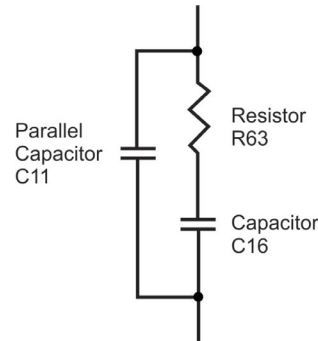

Figure 6.22 – Factory-installed Default RC Network

**STEP 4: (Optional) Verify Suitability of Default Compensation (CC1)**

If desired, the following values of the components contained in the default RC network can be used with the formulas provided in **STEP 5** below to verify the suitability of the default compensation for your uses.

- Compensation Resistor:** 75k ohms
- Compensation Capacitor:** 47 nF
- Parallel Capacitor:** 100 pF

**STEP 5: Calculating Values for an RC Network for Custom Compensation**

If the default RC network does not provide suitable compensation for your intended load, you will need to install a custom RC network that is matched to your load. This network will require two components (a resistor (R) and a capacitor (C)) to be installed on the amplifier's UFEB board. To calculate the approximate values required for each component, use the following formulas.

**COMPENSATION FORMULAS:**

To find the value for the resistor (Rc) in the RC network:  **$R_c = 20,000 \times 3.14 \times L \times BW$**

where:

**Rc** is compensation resistance in ohms.

**L** is load inductance in henries.

**BW** is bandwidth in hertz.

To find the value for the capacitor ( $C_c$ ) in the RC network:  $C_c = L / (R \times R_c)$

where:

$C_c$  is compensation capacitance in farads.

$L$  is load inductance in henries.

$R$  is resistance of load in ohms.

$R_c$  is compensation resistance in ohms.

### STEP 6: Installing and Enabling the Custom RC Network

Once an approximate  $R_c$  and  $C_c$  have been computed, these values will need to be evaluated. To do this, you will need to install the custom components in the amplifier and enable the alternate compensation network (CC2).

Refer to the topic “Internal Jumpers and Settings” in the *Advanced Configuration* section of this manual for instructions on accessing the

UFEB board in the amplifier. Then locate **jumper J3**, and remove the shunt from **pins 1 and 2**. Replace the shunt on **pins 2 and 3** of **jumper J3** to enable the custom RC network pathway (CC2).

Next, install components with the required values in the UFEB board at locations **R5** and **C2** as shown in **Figure 6.23**.

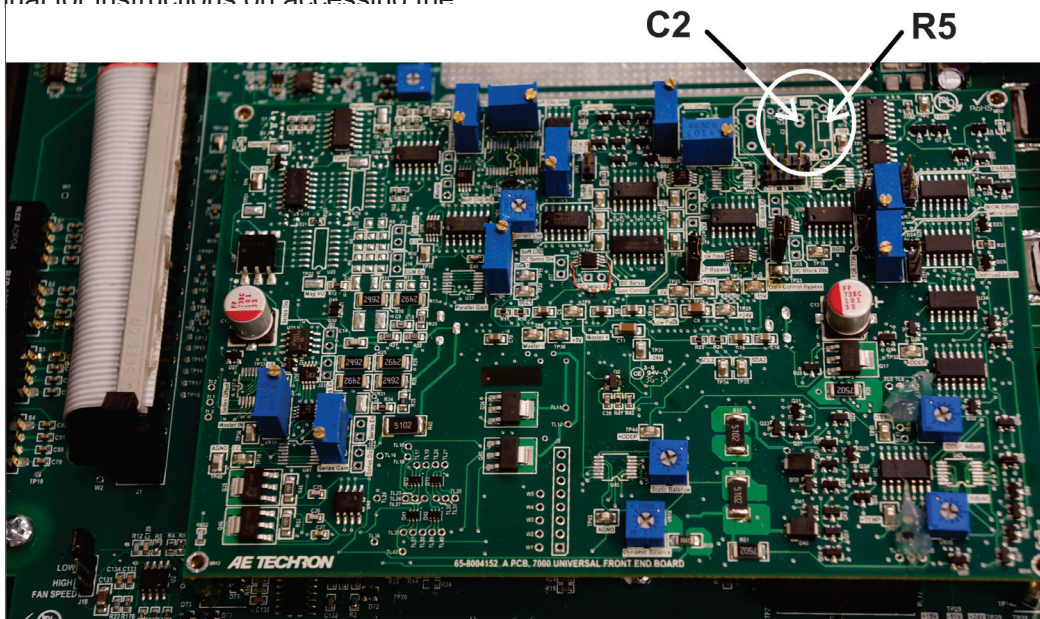

Figure 6.23 – Custom Compensation Component Locations

### STEP 7: Optimizing the Compensation Values.

**Remember the load you are connecting is a part of the system and the amplifier should not be turned on without the load being connected.**

After installing the components, check to ensure that the Controlled Mode DIP switch is set to Current mode, then power up the amplifier without signal input.

To begin testing, input a square wave with a frequency of 100 Hz to 1 kHz, or a squared pulse at a low level (typically 0.25 to 2.0 volts). A limited-rise-time, repetitive pulse of low duty cycle is preferred.

Observe the output current through a current monitor or current probe. Look for clean transition edges. The presence of ringing or rounding on the transition edges indicates compensation problems. (See **Figure 6.24**.)

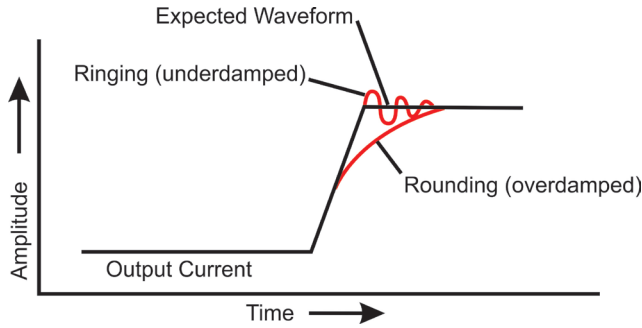
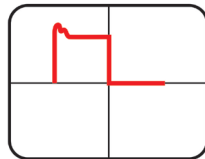

Figure 6.24 – Compensation Effects on Waveform

If a change in compensation is necessary, an adjustment to the resistor component of the Compensation circuit is probably required.

If the output current waveform is ringing, the circuit is underdamped: You have too much compensation and should lower the resistance (see **Figure 6.25**).



Decrease R

Figure 6.25 – Square Wave Showing a Decrease in R is Required

If the output current waveform is rounded, the circuit is overdamped: You have too little compensation and should increase resistance (see **Figure 6.26**).

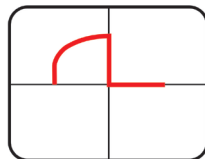

Increase R

Figure 6.26 – Square Wave Showing an Increase in R is Required

If the output current waveform is neither underdamped or overdamped, but the top of the squarewave is not level, then you should instead decrease the capacitor value (see **Figure 6.27**).

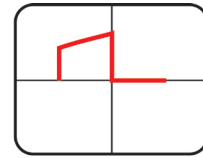

Decrease C

Figure 6.27 – Square Wave Showing a Decrease in C is Required

When making adjustments:

**Resistor:** Increase or decrease resistance values in increments of +/- 10%.

**Capacitor:** Incrementally decrease capacitor values by a factor of 2 or 3.

After final adjustments have been made to the circuit, the final waveform for your planned application should be tested to confirm the amplifier's compensation setting.

**NOTE:**

- If possible, use 1% metal film resistors. AE Techron discourages installation of potentiometers in the resistor location of the compensation circuit because this can decrease stability and may increase inductance.
- The parallel capacitor in the RC network serves to increase stability but can be removed, if it is not required for system stability. If the parallel capacitor is used, it will usually decrease the value of resistance needed.
- In multiple amplifier systems, expect to decrease the value of R5 in series systems by 1/2.



## 6.5 DC Servo

The DC Servo circuit actively monitors the amplifier input for DC offset and automatically corrects for DC drift. When any signal lower than 5 Hz is observed, the DC Servo circuit works with the 7228 amplifier's AC Coupling feature to null out these low-frequency and DC signals.

Use the DC Servo function when powering coils or transformers to minimize circulating DC currents and avoid harmful overheating. Especially when using coupling transformers like the AE Techron T-Series transformers, use of the DC Servo function is recommended.

**NOTE:** The DC Servo and AC Coupling functions work together to achieve the best control of DC offset and drift. While AC Coupling can be enabled individually, if the DC Servo function is enabled while the AC Coupling function is disabled, the amplifier will automatically be placed in Standby mode. To return the amplifier to operational conditions, enable both DC Servo and the AC Coupling (both DIP switches in the DOWN position).

## 6.6 Current Limiting

Four DIP switches control the Current Limiting feature on the 7228. These allow configuration of a current limit from 4 to 60 amps in 4-amp increments.

Use the Current Limit setting when testing to protect delicate devices from possible over-current conditions.

When all four switches are in the UP position (default), the amplifier's output current is limited to 60A. The current-limit can be lowered in 4A increments by setting one or more of the current limit switches in the DOWN position. Refer to **Figure 6.28** for all available current-limit switch settings.

**NOTE:** If all four current-limit DIP switches are set in the DOWN position, the amplifier will be placed in Standby/Stop mode. To return the amplifier to operational conditions, set at least one of the current-limit DIP switches in the UP position.

ON = DIP Switch UP    OFF = DIP Switch DOWN				
SW#13	SW#14	SW#15	SW#16	Current Limit
ON	ON	ON	ON	60A
ON	ON	ON	OFF	56A
ON	ON	OFF	ON	52A
ON	ON	OFF	OFF	48A
ON	OFF	ON	ON	44A
ON	OFF	ON	OFF	40A
ON	OFF	OFF	ON	36A
ON	OFF	OFF	OFF	32A
OFF	ON	ON	ON	28A
OFF	ON	ON	OFF	24A
OFF	ON	OFF	ON	20A
OFF	ON	OFF	OFF	16A
OFF	OFF	ON	ON	12A
OFF	OFF	ON	OFF	8A
OFF	OFF	OFF	ON	4A
OFF	OFF	OFF	OFF	FAULT

Figure 6.28 – Current Limit Switch Configurations

## 7 Maintenance

Simple maintenance can be performed by the user to help keep the equipment operational. The following routine maintenance is designed to prevent problems before they occur. See the **Troubleshooting** section, for recommendations for restoring the equipment to operation after an error condition has occurred.

Preventative maintenance is recommended after the first 250 hours of operation, and every three months or 250 hours thereafter. If the equipment environment is dirty or dusty, preventative maintenance should be performed more frequently.

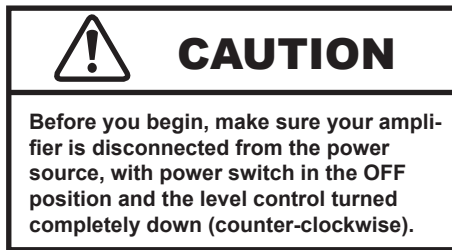

### 7.1 Clean Amplifier Filter and Grills

#### 7.1.1 Tools Required

The recommended equipment and supplies needed to perform the functions required for this task are described below.

- Vacuum cleaner
- Damp cloth (use water only or a mild soap diluted in water)

To ensure adequate cooling and maximum efficiency of the internal cooling fans, the amplifier's front and rear grills should be cleaned periodically. To clean the amplifier grills and filter, complete the following steps:

1. Turn completely down (counter-clockwise) all level controls and turn the amplifier OFF. Disconnect the amplifier from its power source.
2. Using a vacuum cleaner, vacuum the front ventilation grill, including the filter behind the grill, and the back ventilation exit grill.
3. Using a damp cloth, clean the front and rear ventilation grills. Dry with a clean cloth or allow to air dry. **IMPORTANT: Grills should be completely dry before plugging in or restarting amplifier.**

## 8 Troubleshooting

### 8.1 Introduction & Precautions

This section provides a set of procedures for identifying and correcting problems with the 7228 amplifier. Rather than providing an exhaustive and detailed list of troubleshooting specifications, this section aims to provide a set of shortcuts intended to get an inoperative amplifier back in service as quickly as possible.

The procedures outlined in this section are directed toward an experienced electronic technician; it assumes that the technician has knowledge of typical electronic repair and test procedures.

Please be aware that the 7228 will undergo frequent engineering updates. As a result, modules and electronic assemblies may not be interchangeable between units. Particularly, the circuit boards undergo periodic engineering modifications that may make interchangeability between units impossible.

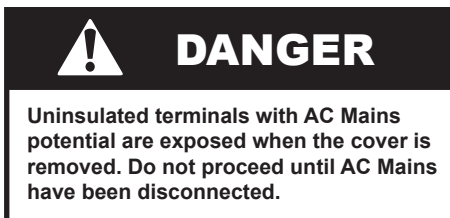

### 8.2 Visual Inspection

Before attempting to troubleshoot the amplifier while it is operating, please take time to complete a visual inspection of the internal components of the amplifier.

1. To perform a Visual Inspection, first turn the Breaker/Switch to the Off (O) position.
2. Disconnect the AC mains plug from the amplifier.
3. Wait three to five minutes for the Power Supply capacitors to discharge.
4. Inspect the amplifier's internal components. Check the following:
5. Inspect modules for charring, breaks, deformation or other signs of physical damage.

6. Look for any foreign objects lodged inside the unit.
7. Inspect the entire lengths of wires and ribbon cables for breaks or other physical damage.
8. If there is any physical damage to the amplifier, please return it to AE Techron for repair.

### 8.3 No Signal

Missing Output signal may be caused by one of the following:

1. One or both of the Master/Slave DIP switches are set to the Slave (down) position. The amplifier should only be configured for Slave operation if it is in a multi-amplifier system; otherwise both the Series Master/Slave and the Parallel Master/Slave DIP switches should be set to the Master (up) position. See the **Advanced Configuration** section in this manual for more information.
2. Signal is not connected to any inputs on the SIM card. See the **Amplifier Setup** section in this manual for more information.

### 8.4 No LEDs Illuminated

If none of the LEDs on the Display Panel are illuminated, check the following:

1. The AC mains are not connected or not on (see the **Amplifier Setup** section for more information).
2. Front Panel Breaker/Switch has been tripped. Reset by turning the unit Off (O) and then On.

### 8.5 OverVoltage LED Lit

The amplifier will protect itself from AC mains voltage that is 10% above the voltage indicated on the back panel. If the AC mains voltage is more than 10% above the operating voltage, reduce the AC mains voltage to the proper level. When the line voltage condition is corrected, press the Reset button to return the amplifier to Run mode. If the amplifier does not reset, the amplifier's three internal transformers may need to be replaced. Please see the **Factory Service** information at the end of this section.

## 8.6 Standby and Stop LEDs Remain Illuminated

Activation of the Ground-Loop Protection Circuit, setting improper DIP switch combinations or a Remote Standby switch will cause the amplifier to enter Standby mode.

1. If the settings on one of the following DIP switches is changed while the amplifier is in Run mode, the amplifier will be placed in Standby/Stop mode: Series Mode (#1), Signal Ground (#4), Controlled Mode (#7), or Power Supply Rail Mode (#10). Push the Enable button to return the amplifier to Run mode. You can also first place the amplifier in Standby/Stop mode before changing the switch settings, and then push the Enable button to return the amplifier to Run mode. Note that if the Series Mode switch (#1) is placed in the DOWN position, the amplifier will be configured as a Slave amplifier for Series operation. When the Enable button is pressed, the amplifier will be placed in Remote Standby mode until it receives the Enable signal from an interlocked Master amplifier.
2. If the Series Mode (#1) and Parallel Mode (#2) DIP switches are both set to the DOWN position, the amplifier will enter Standby/Stop mode. The Enable button will not release the amplifier until one or both of these switches is placed in the UP position.
3. If the Expansion Port is being used, the amplifier might be held in Remote Standby mode by another device. For more information on 7228 Remote Operation, see the **Applications** section in this manual.

## 8.7 Standby LED Remains Illuminated

Activation of the Ground-Loop Protection Circuit or setting improper DIP switch combinations will cause the amplifier to enter Standby mode.

1. If the Ground-Loop Protection Circuit is triggered by a ground loop or excessive circulating currents, the amplifier will be placed in Standby mode. Eliminate the conditions causing the ground loop/circulating currents, and the amplifier will automatically return to Run mode.
2. If the DC Servo (#11) DIP switch is set in the

DOWN position while the Input Coupling (#6) DIP switch is set in the UP position, the amplifier will enter Standby mode. Change the DC Servo switch to the UP position or change the Input Coupling switch to the DOWN position. The amplifier will be automatically returned to Run mode.

3. If the Current Limit DIP switches (#13 to #16) are all placed in the DOWN position, the amplifier will enter Standby mode. Change as least one of these four switches to the UP position. The amplifier will be automatically returned to Run mode.

The Standby indicator may remain illuminated under two conditions not related to the DIP switches:

1. If the output wells or power transformer have overheated. If overheating is the problem, see the following topic (“**Amplifier Overheats**”).
2. If the connection to the Expansion Port or other input/output connection isn't fully secure. Check all wiring and connections.

## 8.8 Amplifier Overheats (Over Temp Fault Condition)

There are two possible reasons why the 7228 amplifier is overheating: Excessive power requirements or inadequate airflow.

### 8.8.1 Excessive Power Requirements

An amplifier will overheat if the required power exceeds the amplifier's capabilities. High duty cycles and low-impedance loads are especially prone to cause overheating. To see if excess power requirements are causing overheating, check the following:

1. The application's power requirements fall within the specifications of the amplifier. See the **Specifications** section.
2. Faulty output connections and load.
3. Undesired DC offset at the Output and Input signal.

If the amplifier chronically overheats with suitable power/load conditions, then the amplifier may not be receiving adequate airflow. To check for adequate airflow, proceed with the following steps:

**8.8.2 Check for Inadequate Airflow**

1. Check air filters. Over time they can become dirty and worn out. It is a good idea to clean the air filters periodically with a mild detergent and water.
2. Visually inspect fans to assure correct operation while amplifier is On (I). When an OverTemp fault occurs, the amplifier fans will automatically be placed in continuous high-speed operation. Any inoperative, visibly slow, or reverse-spinning fan should be replaced. Please see the Factory Service information at the end of this section.

An OverTemp condition places the amplifier in Standby mode. If the OverTemp pulse is extremely short, as in the case of defective wiring or switches, the OverTemp pulse may be too brief to observe.

**8.8.3 Resetting After OverTemp**

To reset the amplifier after an OverTemp has occurred, make sure fans are running (the amplifier fans should switch to high-speed operation when an OverTemp fault occurs). Remove the input signal from the amplifier and allow the fans to run for several minutes until the amplifier has cooled sufficiently and the fans switch to low-speed operation. Then push the Reset button to reset the amplifier.

**NOTE:** If the fans have been configured for Always-On High-Speed operation, the fans will not switch to low speed when the amplifier has cooled sufficiently. To reset the amplifier, wait about 5 minutes to allow the amplifier to cool, and then push the Reset button. If the amplifier does not reset, wait a little longer and then press and hold the Reset button until the OverTemp indicator turns off. Then press the Enable button to return the amplifier to Run mode.

If the fault condition does not clear, return the amplifier for Factory Service.

**8.9 Fault LED is Illuminated**

The 7228 contains protection circuitry that disables the amplifier if an output stage is behaving abnormally. This usually indicates an output transistor has shorted.

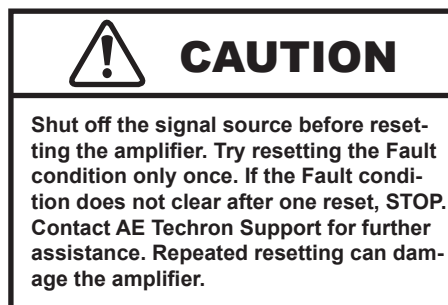

To clear the Fault condition, follow these steps:

1. Turn off the signal source.
2. Turn off the AC mains.
3. Turn AC mains power back on. If the Fault LED doesn't illuminate again, turn the signal source on.
4. If the Fault LED is still illuminated and the Fault condition doesn't clear, return the amplifier for Factory Service. See the Factory Service information at the end of this section.

**8.10 Factory Service**

If the troubleshooting procedures are unsuccessful, the amplifier may need to be returned for Factory Service. All units under warranty will be serviced free of charge (customer is responsible for one-way shipping charges as well as any custom fees, duties, and/or taxes). Please review the Warranty at the beginning of this manual for more information.

All service units must be given Return Authorization by AE Techron, Inc. before being returned. Return Authorizations can be requested on our website or by contacting our Customer Service Department.

Please take extra care when packaging your amplifier for repair. It should be returned in its original packaging or a suitable alternative. Replacement packaging materials can be purchased for a nominal fee.

Please send all service units to the following address and be sure to include your Return Authorization Number on the box.

**AE Techron, Inc.**  
**Attn: Service Department / RMA#**  
**2507 Warren Street**  
**Elkhart, IN 46516**



## 9 Specifications

### Performance

Testing was done at 100 Hz. Continuous DC power levels are lower. See DC Specifications chart.

7228 accuracy was measured when driven into a 10-ohm load with between 0.1VDC and 6VDC or between 0.2VAC and 5VAC presented at its inputs.

#### Small Signal Frequency Response:

DC - 400 kHz, +0.0 to -1.0 dB

Series configuration supported to 200 kHz

#### Slew Rate:

100 V/μSec

#### Residual Noise:

10 Hz to 500 kHz: 900 μV (0.90 mV)

20 Hz to 20 kHz: 350 μV (0.35 mV)

#### Signal-to-Noise Ratio:

10 Hz - 30 kHz: -109.5 dB

10 Hz - 80 kHz: -106.3 dB

10 Hz - 500 kHz: -100.5 dB

Unit to Unit Phase Error: ±0.1 degrees at 60 Hz

THD: DC - 30 kHz, less than 0.1%

#### Output Offset:

With DC Servo Off: Less than ±5mVDC

With DC Servo On: Less than ±400 μVDC or Δf

DC Drift (after 20 minutes of operation):

With DC Servo Off: Less than ±1.5mVDC

With DC Servo On: Less than ±200 μVDC or Δf

#### Output Impedance:

5.3 mOhm in Series with 0.95 μH

#### Phase Response:

0 to -5 degrees (10 Hz - 10 kHz) plus 750 nsec propagation delay

### Input Characteristics

#### Balanced with ground:

Three terminal barrier block connector, 20k ohm differential

#### Unbalanced:

BNC connector, 10k ohm single ended.

#### Gain (factory default):

Voltage Mode: 20 volts/volt max

Current Mode: 5 amperes/volt max

Gain Linearity (over input signal, from 0.2V to 5V):

0.05% (DC); 0.15% (AC)

#### Max Input Voltage:

± 10 V balanced or unbalanced

### Display, Control, Status, I/O

#### Front Panel LED Displays indicate:

Ready, Standby, Fault, Over Temp, Over Voltage, Overload

#### Soft Touch Switches for:

Run, Stop, Reset

#### Gain Control, when enabled:

Voltage gain adjustable from 20 to 0

#### On/Off Breaker

#### Back Panel Power Connection:

25 Amp IEC (with retention latch)

#### Signal Output:

Three-position terminal strip (OUTPUT/COM/CHASSIS GROUND)

#### Signal Input:

User Selectable BNC or Barrier Strip, Balanced or Unbalanced

### Communication Capabilities

#### Current Monitor:

5A/V ± 1%; 2.5A/V ± 1% (differential configuration)

#### Reporting:

System Fault, Over Temp, Over Voltage, Over Load

#### Remote Control via Expansion Port:

Blanking control, Force to Standby, Reset after a fault; plus all DIP switch functions can be operated remotely

### Physical Characteristics

#### Chassis:

The Amplifier is designed for stand-alone or rack-mounted operation. The Chassis is black aluminum with a powder coat finish. The unit occupies two EIA 19-inch-wide units.

#### Weight:

41 lbs (18.6 kg), Shipping 51 lbs (23.2 kg)

#### AC Power:

Single phase, 120 VAC, 60 Hz, 20 Amp service; (220-240 VAC, 50-60 Hz, 10 Amp service model available)

#### Operating Temperature:

10°C to 50°C (50°F to 122°F), maximum output Power de-rated above 30°C (86°F.)

#### Humidity:

70% or less, non-condensing

#### Cooling:

Forced air cooling from front to back through removable filters.

#### Airflow:

180CFM

**Dimensions:**

19" x 22.75" x 3.5" (48.3 cm x 57.8 cm x 8.9 cm)

**Protection****Over/Under Voltage:**

± 10% from specified supply voltage amplifier is forced to Standby

**Over Current:**

Breaker protection on both main power and low voltage supplies

**Over Temperature:**

Separate Output transistor, heat sink, and transformer temperature monitoring and protection

**DC Specifications –****High-Current Mode**

VDC	OUTPUT (Amperes)	
	5 Minutes, 100% Duty Cycle	1 Hour, 100% Duty Cycle
48	21	16
24	25	25
13.5	20	16

**AC Specifications – High-Voltage Mode**

Ohms	PEAK OUTPUT						RMS OUTPUT					
	40 mSec Pulse, 20% Duty Cycle		5 Minutes, 100% Duty Cycle		1 Hour, 100% Duty Cycle		5 Minutes, 100% Duty Cycle		1 Hour, 100% Duty Cycle			
	Volts	Amps	Volts	Amps	Volts	Amps	Volts	Amps	Volts	Amps	Watts	
16	160	10	153	10	153	10	108	7	108	7	731	
8	148	18	136	16	126	15.8	96	12	89	11.2	1000**	
4	120	29	90	22	63	15.7	64	16	45	11.2	500	
2	92	45	47	23	47	23	33	16	33	16	550	

**AC Specifications – Mid-Level Mode**

Ohms	PEAK OUTPUT						RMS OUTPUT					
	40 mSec Pulse, 20% Duty Cycle		5 Minutes, 100% Duty Cycle		1 Hour, 100% Duty Cycle*		5 Minutes, 100% Duty Cycle		1 Hour, 100% Duty Cycle*			
	Volts	Amps	Volts	Amps	Volts	Amps	Volts	Amps	Volts	Amps	Watts	
8	84.5	10.5	80	10	80	10	57	7	57	7	400	
4	77	19	73	18	73	18	54	13	54	13	700	
2	67	33	61	30	56	27	43	21	39	19	769	
1	52	51	47	46	26	26	33	33	20	20	400	
0.5	30	60	13	26	10	20	9.8	18	7.3	14	100	

**AC Specifications – High-Current Mode**

Ohms	PEAK OUTPUT						RMS OUTPUT					
	40 mSec Pulse, 20% Duty Cycle		5 Minutes, 100% Duty Cycle		1 Hour, 100% Duty Cycle*		5 Minutes, 100% Duty Cycle		1 Hour, 100% Duty Cycle*			
	Volts	Amps	Volts	Amps	Volts	Amps	Volts	Amps	Volts	Amps	Watts	
2	33	16	33	16	33	16	24	12	24	12	273	
1	29	28	28	28	28	28	20	19	20	19	388	
0.75	26	34	26	34	26	34	18	24	18	24	452	
0.5	22	43	22	43	22	43	16	31	16	31	488	
0.25	14	53	11	45	11	45	8	32	8	32	256	

Testing performed with fans set to Auto, 1 kHz sinewave input signal, resistive load, 20°C ambient temperature.

\*Testing performed with Bi-level setting set to Manual, Low.

\*\*Continuous operation for 45 minutes.

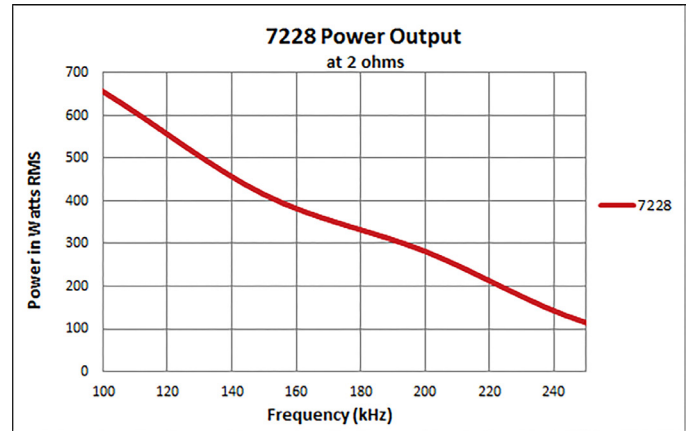
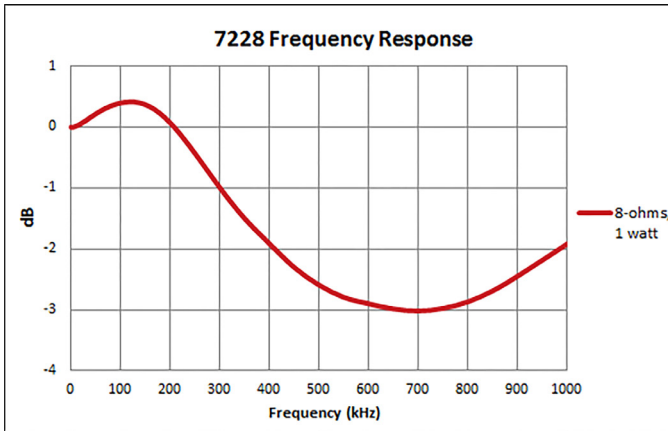
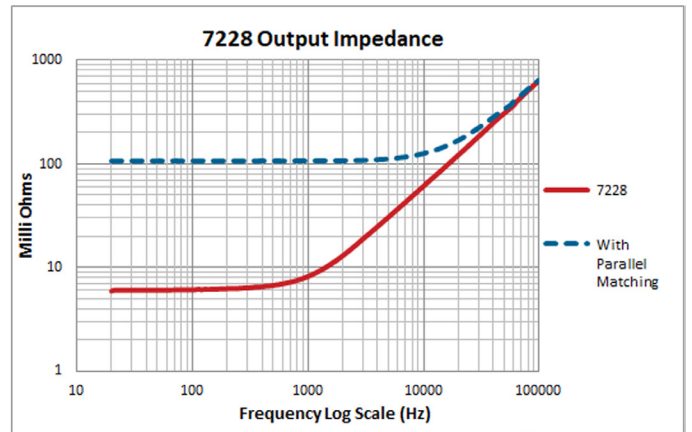
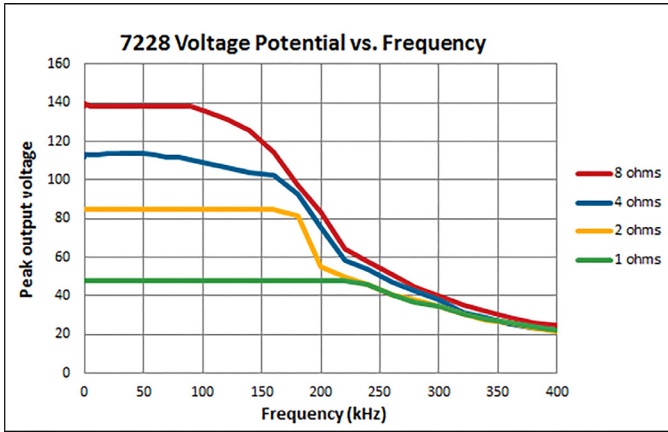

## Appendix A: Accessory Connector Pinouts and Functions

Pin #	Function	Description	Signal Type	Level when Asserted	Level when Deasserted	Notes	Applications
1	Amplifier Output (Fused)	Used for driving slave amplifiers in Series mode	AC or DC	Can be greater than $\pm 200V$ peak	0V	Used for driving slave amplifiers in multi-amp systems. Wired to amplifier output. Do not connect to any impedance of less than 10K ohm. NOTE: Output is fused.	<b>Multi-amplifier Series Slave Output:</b> Connect to the Series Slave In + (Pin 44) when used in Multi-amplifier Series Mode.
2	Amplifier Output (Fused)	Used for monitoring amplifier output voltage	AC or DC	Can be greater than $\pm 200V$ peak	0V	Used for monitoring amplifier output voltage. Do not connect to any impedance of less than 10K ohm. NOTE: Output is fused.	<b>Voltage Monitoring:</b> Connect a voltage meter to monitor the output voltage being produced by the amplifier. Connect across PIN 2 (Amp Out) and PIN 22, 23 or 24 (Analog Ground).
3	None	No Connection					
4	Parallel Master Out 1+	Differential Input from Parallel Master Output Signal	AC or DC	$\pm 15V$ peak	0V	Used in multiple amplifier configurations in Parallel Mode.	<b>Multi-amplifier Parallel Mode:</b> Parallel Systems Simultaneous Line Level Output from the Master Amplifier.
5	Parallel Master Out 1-	Differential Input from Parallel Master Output Signal	AC or DC	$\pm 15V$ peak	0V	Used in multiple amplifier configurations in Parallel Mode.	<b>Multi-amplifier Parallel Mode:</b> Parallel Systems Simultaneous Line Level Output from the Master Amplifier.
6	Parallel Master Out 2+	Differential Input from Parallel Master Output Signal	AC or DC	$\pm 15V$ peak	0V	Used in multiple amplifier configurations in Parallel Mode.	<b>Multi-amplifier Parallel Mode:</b> Parallel Systems Simultaneous Line Level Output from the Master Amplifier.
7	Parallel Master Out 2-	Differential Input from Parallel Master Output Signal	AC or DC	$\pm 15V$ peak	0V	Used in multiple amplifier configurations in Parallel Mode.	<b>Multi-amplifier Parallel Mode:</b> Parallel Systems Simultaneous Line Level Output from the Master Amplifier.
8	Parallel Master Out 3+	Differential Input from Parallel Master Output Signal	AC or DC	$\pm 15V$ peak	0V	Used in multiple amplifier configurations in Parallel Mode.	<b>Multi-amplifier Parallel Mode:</b> Parallel Systems Simultaneous Line Level Output from the Master Amplifier.
9	Parallel Master Out 3-	Differential Input from Parallel Master Output Signal	AC or DC	$\pm 15V$ peak	0V	Used in multiple amplifier configurations in Parallel Mode.	<b>Multi-amplifier Parallel Mode:</b> Parallel Systems Simultaneous Line Level Output from the Master Amplifier.
10	None	No Connection	DC				
11	None	No Connection					
12	Current Limit bit 0 (4A)	Same function as DIP Switch of same name	DC	5V to 15V	0V	The DIP switch needs to be in the UP position for this input to function. Reference Isolation Ground (Pin 62).	<b>Remote Control:</b> Remote control to set the Current Limit. When asserted, 4A not allowed; when deasserted, 4A allowed.
13	Current Limit bit 1 (8A)	Same function as DIP Switch of same name	DC	5V to 15V	0V	The DIP switch needs to be in the UP position for this input to function. Reference Isolation Ground (Pin 62).	<b>Remote Control:</b> Remote control to set the Current Limit. When asserted, 8A not allowed; when deasserted, 8A allowed.

Pin #	Function	Description	Signal Type	Level when Asserted	Level when Deasserted	Notes	Applications
14	Current Limit bit 2 (16A)	Same function as DIP Switch of same name	DC	5V to 15V	0V	The DIP switch needs to be in the UP position for this input to function. Reference Isolation Ground (Pin 62).	<b>Remote Control:</b> Remote control to set the Current Limit. When asserted, 16A not allowed; when deasserted, 16A allowed.
15	Current Limit bit 3 (32A)	Same function as DIP Switch of same name	DC	5V to 15V	0V	The DIP switch needs to be in the UP position for this input to function. Reference Isolation Ground (Pin 62).	<b>Remote Control:</b> Remote control to set the Current Limit. When asserted, 32A not allowed; when deasserted, 32A allowed.
16	None	No Connection					
17	None	No Connection					
18	Control Mode Volt/Current	Same function as DIP Switch of same name	DC	5V to 15V	0V	The DIP switch needs to be in the UP position for this input to function. Reference Isolation Ground (Pin 62).	<b>Remote Control:</b> Remote control to switch between Control Voltage and Control Current modes. When asserted, CC mode is enabled; when deasserted, CV mode is enabled.
19	None	No Connection					
20	Interlock Ground	Interlock common	DC	0V	0V	The Slave Interlocks are referenced to the Master Interlock Ground.	<b>Multi-amplifier:</b> Used with Interlock (Pin 21) and Interlock 15V (pin 42). Connect all amplifier Interlock Grounds together.
21	Interlock	Amplifier Interlock Input	DC	0V (Interlock Ground)	Open	When "low" (tied to Interlock Ground, Pin 20), forces the amplifier to Standby; when allowed to float, allows Run (if amplifier is "Ready"). <b>IMPORTANT:</b> amplifiers must be configured for Run mode at startup (factory default) or the Run button must be pressed at the amplifier front panel at startup.	<b>Remote to Standby:</b> Short Pin 21 to Interlock Ground (Pin 20) using dry contact or optocoupler. When closed, places amplifier in Standby. <b>Multi-amplifier:</b> To simultaneous Enable or Disable amplifiers, daisy chain Interlock (Pin 21) across multiple amplifiers.
22	Analog Ground	Amp Analog Ground	DC	0V	0V	Amplifier Analog Ground.	<b>Used in status reporting applications.</b> See Voltage Monitor (PIN 2), Run (PIN 46), OverVoltage (PIN 47), OverLoad (PIN 48), OverTemp (PIN 49) and Amp Fault (PIN 50).
23	Analog Ground	Amp Analog Ground	DC	0V	0V	Amplifier Analog Ground.	<b>Used in status reporting applications.</b> See Voltage Monitor (PIN 2), Run (PIN 46), OverVoltage (PIN 47), OverLoad (PIN 48), OverTemp (PIN 49) and Amp Fault (PIN 50).
24	Analog Ground	Amp Analog Ground	DC	0V	0V	Amplifier Analog Ground.	<b>Used in status reporting applications.</b> See Voltage Monitor (PIN 2), Run (PIN 46), OverVoltage (PIN 47), OverLoad (PIN 48), OverTemp (PIN 49) and Amp Fault (PIN 50).
25	Parallel Slave In +	Differential Parallel Slave Input	AC or DC	±15V peak	0V	Only used in multi-amplifier configurations - Parallel Mode	<b>Multi-amplifier:</b> Connects to the Master amplifier Parallel Out 1+, 2+, or 3+.
26	Parallel Slave In -	Differential Parallel Slave Input	AC or DC	±15V peak	0V	Only used in multi-amplifier configurations - Parallel Mode	<b>Multi-amplifier:</b> Connects to the Master amplifier Parallel Out 1-, 2-, or 3-.



Pin #	Function	Description	Signal Type	Level when Asserted	Level when Deasserted	Notes	Applications
27	None	No Connection					
28	Gain 20:1/6:1	Same function as DIP Switch of same name	DC	5V to 15V	0V	The DIP switch needs to be in the UP position for this input to function. Reference Isolation Ground (Pin 62).	<b>Remote Control:</b> Remote control to set the Gain to 6:1. Default is 20:1. When Asserted, the Gain will be set to 6:1.
29	Unit ID Output	The amplifier model ID via voltage level.	DC	7228: 4V		The Unit ID is based on a voltage divider circuit between 0 to 15V.	Identifies which model the amplifier is.
30	+24V Output (Fused)	+24V DC Output	DC			+24 V DC, 30 mA max, referenced to Analog Ground (PINS 22, 23, and 24). Actual output is between 21V and 24V. Output is fused.	+24V unregulated output.
31	-24V Output (Fused)	-24V DC Output	DC			-24V DC, 30 mA max, referenced to Analog Ground (PINS 22, 23, and 24). Actual output is between -21V and -24V. Output is fused.	-24V unregulated output.
32	None	No Connection					
33	None	No Connection					
34	DC Servo Off/ On	Same function as DIP Switch of same name	DC	5V to 15V	0V	The DIP switch needs to be in the UP position for this input to function. Reference Isolation Ground (Pin 62).	<b>Remote Control:</b> Remote control to set the DC Servo. Default is Off. When Asserted, the DC Servo is On.
35	Temp Signal Out	Compares +TEMP to -TEMP and reports higher value	DC	2.93V to 3.73V (20°C to 100°C)		Voltage observed at Temp Signal Out reported in degrees Kelvin (1V = 100°K). Convert to Fahrenheit (°F = 1.8 x (°K - 273) + 32); Convert to Celsius (°C = °K - 273).	<b>Remote Reporting of Temperature Level:</b> Connect a voltage meter to monitor the output voltage being produced by the amplifier. Connect across PIN 35 (Temp Signal Out) and PIN 22, 23 or 24 (Analog Ground).
36	None	No Connection					
37	Power Supply Rail Mode - HV/HC	Same function as DIP Switch of same name	DC	5V to 15V	0V	The DIP switch needs to be in the UP position for this input to function. Reference Isolation Ground (Pin 62).	<b>Remote Control:</b> Remote control to set the Power Supply Rail Mode between High Voltage (Default) and High Current (Asserted).
38	Manual Bi-level Mode - Low/High	Same function as DIP Switch of same name	DC	5V to 15V	0V	The DIP switch needs to be in the UP position for this input to function. Reference Isolation Ground (Pin 62).	<b>Remote Control:</b> Remote control to set the Manual Bi-Level Mode between Low (Default) and High (Asserted). Pin 39 needs to be asserted for this function to operate.
39	Bi-level Mode - Auto/Manual	Same function as DIP Switch of same name	DC	5V to 15V	0V	The DIP switch needs to be in the UP position for this input to function. Reference Isolation Ground (Pin 62).	<b>Remote Control:</b> Remote control to set the Bi-Level Mode between Auto (Default) and Manual (Asserted).
40	Input Coupling DC/AC	Same function as DIP Switch of same name	DC	5V to 15V	0V	The DIP switch needs to be in the UP position for this input to function. Reference Isolation Ground (Pin 62).	<b>Remote Control:</b> Remote control to set the Input Coupling between DC coupled or DC blocked. When asserted, DC will be blocked and amplifier will be AC coupled.
41	None	No Connection					

Pin #	Function	Description	Signal Type	Level when Asserted	Level when Deasserted	Notes	Applications
42	Interlock +15V Power (Fused)	+15V DC supply for the Slave Interlocks.	DC	0V	0V	The Master Interlock supplies +15V DC to the Slave Interlock circuits. This supply is fused.	<b>Multi-amplifier:</b> Used with Interlock (Pin 21) and Interlock Ground (pin 20). Connect all amplifier Interlock +15V pins together.
43	Series Slave In -	Differential Slave Input	AC or DC	Can be greater than $\pm 200V$ peak	0V	Used in multiple amplifier configurations in Series Mode.	<b>Multi-amplifier:</b> Connect to Analog Ground (Pin 22, 23, or 24) when the amplifier is in Slave Mode.
44	Series Slave In +	Differential Slave Input	AC or DC	Can be greater than $\pm 200V$ peak	0V	Used in multiple amplifier configurations in Series Mode.	<b>Multi-amplifier:</b> Connect to Amplifier Output (Pin 1) when the amplifier is in Slave Mode.
45	None	No Connection					
46	Run Status	Amplifier Run Output	DC	15V	0V	When the amplifier is in a Run state, the level is asserted and the output is tied to 15V through a 2k ohm resistor. When the amplifier is in Standby, the output level is at 0V (Analog Ground). The output is limited to 7 mA. Reference is to the Analog Ground (Pin 22, 23, or 24).	<b>Remote Signal of Run Condition:</b> Output indicates a Run State.
47	OverVoltage Output	OverVoltage Output (High AC line voltage)	DC	15V	0V	When the amplifier is in an OverVoltage state, the level is asserted and the output is tied to 15V through a 2k ohm resistor. When the amplifier is in normal operation, the output level is at 0V (Analog Ground). The output is limited to 7 mA. Reference is to the Analog Ground (Pin 22, 23, or 24).	<b>Remote Signal of OverVoltage Condition:</b> Output indicates if an OverVoltage condition exists.
48	OverLoad Output	OverLoad Output (Amplifier is clipping)	DC	15V	0V	When the amplifier is in an OverLoad state, the level is asserted and the output is tied to 15V through a 2k ohm resistor. When the amplifier is in normal operation, the output level is at 0V (Analog Ground). The output is limited to 7 mA. Reference is to the Analog Ground (Pin 22, 23, or 24).	<b>Remote Signal of OverLoad Condition:</b> Output indicates if an OverLoad condition exists.
49	Over Temp Output	Over Temperature Output	DC	15V	0V	When the amplifier is in an Over Temperature state, the level is asserted and the output is tied to 15V through a 2k ohm resistor. When the amplifier is in normal operation, the output level is at 0V (Analog Ground). The output is limited to 7 mA. Reference is to the Analog Ground (Pin 22, 23, or 24).	<b>Remote Signal of Over Temp Condition:</b> Output indicates if an Over Temp condition exists.

Pin #	Function	Description	Signal Type	Level when Asserted	Level when Deasserted	Notes	Applications
50	Amp Fault Output	Indicates a fault condition	DC	15V	0V	When the amplifier is in a Fault state, the level is asserted and the output is tied to 15V through a 2k ohm resistor. When the amplifier is in normal operation, the output level is at 0V (Analog Ground). The output is limited to 7 mA. Reference is to the Analog Ground (Pin 22, 23, or 24).	<b>Remote Signal of Amplifier Fault Condition:</b> Output indicates if a fault condition exists.
51	I MON – Output	Differential Current Monitor –	AC or DC	5A/V		I MON– (Inverted I MON+, Pin 52). Output current produced when voltage is detected.	<b>Current Monitoring:</b> Connect a voltage meter to monitor the output current being produced by the amplifier. For each 1V detected, current output is 5A when referenced to Analog Ground (Pin 22, 23, or 24). For each 1V detected, the current output is 2.5A when referenced differentially with I MON + (Pin 52).
52	I MON + Output	Differential Current Monitor +	AC or DC	5A/V		Output current produced when voltage is detected.	<b>Current Monitoring:</b> Connect a voltage meter to monitor the output current being produced by the amplifier. For each 1V detected, current output is 5A when referenced to Analog Ground (Pin 22, 23, or 24). For each 1V detected, the current output is 2.5A when referenced differentially with I MON - (Pin 51).
53	None	No Connection					
54	Input Signal Unbal/Bal	Same function as DIP Switch of same name	DC	5V to 15V	0V	The DIP switch needs to be in the UP position for this input to function. Reference Isolation Ground (Pin 62).	<b>Remote Control:</b> Remote control to set the Input Signal between Unbalanced (Default) or Balanced (Asserted).
55	Parallel Matching Off/ On	Same function as DIP Switch of same name	DC	5V to 15V	0V	The DIP switch needs to be in the UP position for this input to function. Reference Isolation Ground (Pin 62).	<b>Remote Control:</b> Remote control to set the Parallel Matching between Off (Default) and On (Asserted).
56	Signal Ground Connected/ Lifted (2.7 ohm)	Same function as DIP Switch of same name	DC	5V to 15V	0V	The DIP switch needs to be in the UP position for this input to function. Reference Isolation Ground (Pin 62).	<b>Remote Control:</b> Remote control to set the Signal Ground as connected (Default) or Lifted (Asserted).
57	Parallel Mode Master/Slave	Same function as DIP Switch of same name	DC	5V to 15V	0V	The DIP switch needs to be in the UP position for this input to function. Reference Isolation Ground (Pin 62).	<b>Remote Control:</b> Remote control to set the Parallel Matching between Master (Default) and Slave (Asserted). When in Slave Mode, the amplifier receives its input from Parallel Slave IN+ (Pin 25) and Parallel Slave IN- (Pin 26)
58	Series Mode Master/Slave	Same function as DIP Switch of same name	DC	5V to 15V	0V	The DIP switch needs to be in the UP position for this input to function. Reference Isolation Ground (Pin 62).	<b>Remote Control:</b> Remote control to set the Series Mode of the amplifier as Master (Default) or Slave (Asserted). When in Slave Mode, the amplifier receives its input from Series Slave In + (Pin 44) and Series Slave In - (Pin 43).
59	Blanking On/ Off Input	Blanking Control	DC	5V to 15V	0V	Used for the Blanking Feature. Reference is to the Isolation Ground (Pin 62).	Blanking Control: Normal amplifier operation when deasserted. Amplifier output is muted when asserted.

Pin #	Function	Description	Signal Type	Level when Asserted	Level when Deasserted	Notes	Applications
<b>60</b>	Amp Reset Input	Reset	DC	5V to 15V	0V	Used to Reset the amplifier.	Reset from Standby: When asserted for at least 100 milliseconds, will return the amplifier to Ready/Run condition after Overload.
<b>61</b>	Amp Enable Input	Enable	DC	5V to 15V	0V	Used to Enable amplifier from standby.	Amplifier Enable: When asserted for at least 100 milliseconds, Enables the amplifier from standby.
<b>62</b>	Isolated Ground	Isolated Ground	DC	0V	0V	Attach the ground from the power supply when used for Blanking, Amp Reset, Amp Enable, and/or DIP Switch Functions to this pin.	Ground reference for use with Blanking, Amp Reset, and Amp Enable signals and DIP Switch pins.
Blue shaded areas indicate used only in multi-amplifier systems.				Green shaded areas indicate DIP switch equivalent.			Gray shaded areas indicate pin not used / feature not implemented.