

R&S®FPC Spectrum Analyzer User Manual



1178413002

This document describes the following R&S®FPC models and options:

- R&S®FPC1000 (1328.6660.02)
- R&S®FPC1500 (1328.6660.03)
- R&S®FPC-B22 Preamplifier (1328.6690.02)
- R&S®FPC-B200 Wi-Fi Support (1328.6990.02)
- R&S®FPC-K7 AM, FM, ASK, FSK demodulation (1328.6748.02)
- R&S®FPC-K42 Vector Network Analysis (1328.7396.02)
- R&S®FPC-K43 Receiver (1328.6754.02)
- R&S®FPC-K55 Advanced Measurements (1328.6760.02)

The contents of this manual correspond to firmware version 1.40 and later.

© 2018 Rohde & Schwarz GmbH & Co. KG

Mühlhofstr. 15, 81671 München, Germany

Phone: +49 89 41 29 - 0

Fax: +49 89 41 29 12 164

Email: info@rohde-schwarz.com

Internet: www.rohde-schwarz.com

Subject to change – Data without tolerance limits is not binding.

R&S® is a registered trademark of Rohde & Schwarz GmbH & Co. KG.

Trade names are trademarks of the owners.

1178.4130.02 | Version 07 | R&S®FPC

Throughout this manual, products from Rohde & Schwarz are indicated without the ® symbol, e.g. R&S®FPC is indicated as R&S FPC.

Safety Instructions

Instrucciones de seguridad

Sicherheitshinweise

Consignes de sécurité

WARNING

Risk of injury and instrument damage

The instrument must be used in an appropriate manner to prevent personal injury or instrument damage.

- Do not open the instrument casing.
 - Read and observe the "Basic Safety Instructions" delivered as printed brochure with the instrument.
 - Read and observe the safety instructions in the following sections. Note that the data sheet may specify additional operating conditions.
 - Keep the "Basic Safety Instructions" and the product documentation in a safe place and pass them on to the subsequent users.
-

ADVERTENCIA

Riesgo de lesiones y daños en el instrumento

El instrumento se debe usar de manera adecuada para prevenir descargas eléctricas, incendios, lesiones o daños materiales.

- No abrir la carcasa del instrumento.
 - Lea y cumpla las "Instrucciones de seguridad elementales" suministradas con el instrumento como folleto impreso.
 - Lea y cumpla las instrucciones de seguridad incluidas en las siguientes secciones. Se debe tener en cuenta que las especificaciones técnicas pueden contener condiciones adicionales para su uso.
 - Guarde bien las instrucciones de seguridad elementales, así como la documentación del producto, y entréguelas a usuarios posteriores.
-

⚠️ WARNUNG**Gefahr von Verletzungen und Schäden am Gerät**

Betreiben Sie das Gerät immer ordnungsgemäß, um elektrischen Schlag, Brand, Verletzungen von Personen oder Geräteschäden zu verhindern.

- Öffnen Sie das Gerätegehäuse nicht.
 - Lesen und beachten Sie die "Grundlegenden Sicherheitshinweise", die als gedruckte Broschüre dem Gerät beiliegen.
 - Lesen und beachten Sie die Sicherheitshinweise in den folgenden Abschnitten; möglicherweise enthält das Datenblatt weitere Hinweise zu speziellen Betriebsbedingungen.
 - Bewahren Sie die "Grundlegenden Sicherheitshinweise" und die Produktdokumentation gut auf und geben Sie diese an weitere Benutzer des Produkts weiter.
-

⚠️ AVERTISSEMENT**Risque de blessures et d'endommagement de l'appareil**

L'appareil doit être utilisé conformément aux prescriptions afin d'éviter les électrocutions, incendies, dommages corporels et matériels.

- N'ouvrez pas le boîtier de l'appareil.
 - Lisez et respectez les "consignes de sécurité fondamentales" fournies avec l'appareil sous forme de brochure imprimée.
 - Lisez et respectez les instructions de sécurité dans les sections suivantes. Il ne faut pas oublier que la fiche technique peut indiquer des conditions d'exploitation supplémentaires.
 - Gardez les consignes de sécurité fondamentales et la documentation produit dans un lieu sûr et transmettez ces documents aux autres utilisateurs.
-

Customer Support

Technical support – where and when you need it

For quick, expert help with any Rohde & Schwarz equipment, contact one of our Customer Support Centers. A team of highly qualified engineers provides telephone support and will work with you to find a solution to your query on any aspect of the operation, programming or applications of Rohde & Schwarz equipment.

Up-to-date information and upgrades

To keep your instrument up-to-date and to be informed about new application notes related to your instrument, please send an e-mail to the Customer Support Center stating your instrument and your wish. We will take care that you will get the right information.

Europe, Africa, Middle East

Phone +49 89 4129 12345
customersupport@rohde-schwarz.com

North America

Phone 1-888-TEST-RSA (1-888-837-8772)
customer.support@rsa.rohde-schwarz.com

Latin America

Phone +1-410-910-7988
customersupport.la@rohde-schwarz.com

Asia/Pacific

Phone +65 65 13 04 88
customersupport.asia@rohde-schwarz.com

China

Phone +86-800-810-8228 /
+86-400-650-5896
customersupport.china@rohde-schwarz.com



Contents

1	Documentation Overview.....	7
2	Regulatory Information.....	9
3	Preparing for Use.....	10
3.1	Unpacking and Checking the Instrument.....	11
3.2	Placing or Mounting the Instrument.....	12
3.3	Connecting AC Power.....	13
3.4	Turning the R&S FPC on and off.....	13
4	Instrument Tour.....	15
4.1	Front Panel.....	15
4.2	Rear Panel.....	17
5	Operation.....	19
5.1	Manual Operation.....	19
5.2	Screen Layout.....	22
5.3	Remote Operation.....	25
6	Firmware Update.....	32
7	Firmware Options.....	34
8	Preset.....	37
9	Instrument Setup.....	39
9.1	BNC Connector Usage.....	39
9.2	Network Configuration.....	39
9.3	Date and Time.....	41
9.4	Regional Settings.....	42
9.5	Display Settings.....	43
9.6	Audio Settings.....	43
9.7	Power Settings.....	44
10	Data Management.....	46
11	Signal Source Configuration.....	52
12	Calibration.....	54

13	Measurement Wizard.....	59
14	The Spectrum Application.....	66
14.1	Configuration Overview.....	66
14.2	Measurements and Result Displays.....	68
14.3	Frequency Configuration.....	93
14.4	Amplitude Configuration.....	98
14.5	Bandwidth Configuration.....	106
14.6	Sweep Configuration.....	109
14.7	Trigger Configuration.....	112
14.8	Trace Configuration.....	113
14.9	Marker Configuration.....	119
14.10	Marker Functions.....	125
14.11	Display Lines.....	129
14.12	Limit Lines.....	130
15	The Receiver Application.....	134
15.1	Measurements and Result Displays.....	134
15.2	Frequency Configuration.....	138
15.3	Amplitude Configuration.....	142
15.4	Bandwidth Configuration.....	143
15.5	Sweep Configuration.....	144
15.6	Trace Configuration.....	144
15.7	Limit Lines.....	145
15.8	Marker Configuration.....	145
16	Analog Demodulation.....	147
16.1	Measurements and Result Displays.....	147
16.2	Frequency Configuration.....	150
16.3	Amplitude Configuration.....	150
16.4	Bandwidth Configuration.....	151
16.5	Sweep Configuration.....	155
16.6	Limits.....	156
17	Digital Demodulation.....	158
17.1	Measurements and Result Displays.....	158

17.2	Measurement Configuration.....	163
17.3	Frequency Configuration.....	166
17.4	Amplitude Configuration.....	167
17.5	Sweep Configuration.....	168
17.6	Trigger Configuration.....	169
18	Vector Network Analyzer.....	170
18.1	Measurements and Result Displays.....	170
18.2	Frequency Configuration.....	179
18.3	Amplitude Configuration.....	181
18.4	Bandwidth Configuration.....	182
18.5	Sweep Configuration.....	183
18.6	Trace Configuration.....	184
18.7	Marker Configuration.....	184
18.8	Limit Line Configuration.....	186
19	Remote Control.....	187
19.1	Remote Control Basics.....	187
19.2	Common Commands.....	202
19.3	Preset.....	206
19.4	Network Connection.....	207
19.5	System Configuration.....	209
19.6	Display Settings.....	215
19.7	Audio Settings.....	215
19.8	Data Management.....	216
19.9	Signal Source Configuration.....	226
19.10	Calibration.....	228
19.11	Applications.....	231
19.12	Remote Commands of the Spectrum Application.....	232
19.13	Remote Commands of the Receiver Application.....	295
19.14	Remote Commands of the Analog Demodulation.....	303
19.15	Remote Commands of the Digital Demodulation.....	313
19.16	Remote Commands of the VNA Application.....	323
19.17	Status Reporting System.....	341

20	Function Reference.....	355
20.1	Function Reference: Setup.....	355
20.2	Function Reference: Data Management.....	358
20.3	Function Reference: Mode Selection.....	359
20.4	Function Reference: Spectrum Application.....	360
20.5	Function Reference: Receiver Application.....	377
20.6	Function Reference: Analog Demodulation.....	387
20.7	Function Reference: Digital Demodulation.....	391
20.8	Function Reference: Vector Network Analyzer.....	395
	List of Commands.....	406
	Index.....	413

1 Documentation Overview

This section provides an overview of the R&S FPC user documentation. You can find it on the product page at:

www.rohde-schwarz.com/manual/fpc

Getting started manual

Introduces the R&S FPC and describes how to set up and start working with the product. A printed version is included in the delivery.

User manual

The user manual contains the description of all instrument modes and functions. It also provides an introduction to remote control, a complete description of the remote control commands with programming examples, and information on maintenance, instrument interfaces and error messages.

In addition to the R&S FPC user manual, there is a separate user manual for the R&S InstrumentView software package. This manual contains a description of all features of the R&S InstrumentView software package.

The online version (html format) of the user manual provides the complete contents for immediate display on the internet.

The user manual is also integrated into the firmware (.chm format). You can export the file to a memory stick ("Setup" > "User Preferences" > "Export Documentation". After the export, you can connect the memory stick to a PC and read the .chm file.

Service manual

Describes the performance test for checking the rated specifications, module replacement and repair, firmware update, troubleshooting and fault elimination, and contains mechanical drawings and spare part lists.

The service manual is available for registered users on the global Rohde & Schwarz information system (GLORIS, <https://gloris.rohde-schwarz.com>).

Basic safety instructions

Contains safety instructions, operating conditions and further important information. The printed document is included in the delivery.

Data sheet and brochure

The data sheet contains the technical specifications of the R&S FPC. It also lists the options and their order numbers as well as optional accessories.

The brochure provides an overview of the R&S FPC and shows its specific characteristics.

Release notes and open source acknowledgment

The release notes list new features, improvements and known issues of the current firmware version, and describe the firmware installation.

The open source acknowledgment document provides verbatim license texts of the used open source software.

www.rohde-schwarz.com/manual/fpc

The open source acknowledgement is also integrated into the firmware (.chm format). You can export the file to a memory stick ("Setup" > "User Preferences" > "Export Documentation"). After the export, you can connect the memory stick to a PC and read the .chm file.

Application notes, application cards, white papers, etc.

These documents contain information about possible applications and background information on various topics, see www.rohde-schwarz.com/appnotes.

Calibration certificates

The calibration certificates of your device are available online. Visit the R&S FPC product page and select the item to download the calibration certificate. You will be forwarded to a Gloris page.

<https://gloris.rohde-schwarz.com/calcert>

Enter the device ID of your R&S FPC and download the certificate. You can find the device ID either in the "Setup" menu or on the label on the rear panel.

2 Regulatory Information

You can access the regulatory information in the firmware of the R&S FPC.

1. Press the "Setup" key.
The R&S FPC opens the "Instrument Setup" menu.
2. Select the "Regulatory Information" menu item in the "WiFi" category with the "Enter" key.
The R&S FPC shows the regulations it complies with.

3 Preparing for Use

The R&S FPC is designated for use in industrial, administrative and laboratory environments. Use the R&S FPC only for its designated purpose. Observe the safety and usage instructions documented in the operating manual, as well as the operating conditions and performance limits stated in the data sheet.

Make sure to consider the following information before using the R&S FPC for the first time.

WARNING

Risk of injury due to disregarding safety information

Observe the information on appropriate operating conditions provided in the data sheet to prevent personal injury or damage to the instrument. Read and observe the basic safety instructions provided with the instrument, in addition to the safety instructions in the following sections. In particular:

- Do not open the instrument casing.

NOTICE

Risk of instrument damage due to inappropriate operating conditions

Specific operating conditions are required to ensure accurate measurements and to avoid damage to the instrument. Observe the information on appropriate operating conditions provided in the basic safety instructions and the instrument's data sheet.

NOTICE

Instrument damage caused by electrostatic discharge

Electrostatic discharge (ESD) can damage the electronic components of the instrument and the device under test (DUT). Electrostatic discharge is most likely to occur when you connect or disconnect a DUT or test fixture to the instrument's test ports. To prevent electrostatic discharge, use a wrist strap and cord and connect yourself to the ground, or use a conductive floor mat and heel strap combination.

NOTICE**Risk of instrument damage during operation**

An unsuitable operating site or test setup can damage the instrument and connected devices. Ensure the following operating conditions before you switch on the instrument:

- The instrument is dry and shows no sign of condensation.
- The instrument is positioned as described in the following sections.
- The ambient temperature does not exceed the range specified in the data sheet.
- Signal levels at the input connectors are all within the specified ranges.
- Signal outputs are correctly connected and are not overloaded.

**EMI impact on measurement results**

Electromagnetic interference (EMI) may affect the measurement results.

To suppress generated electromagnetic interference (EMI):

- Use suitable shielded cables of high quality. For example, use double-shielded RF and LAN cables.
- Always terminate open cable ends.
- Note the EMC classification in the data sheet.

3.1 Unpacking and Checking the Instrument

Unpack the R&S FPC carefully and check the contents of the package.

- Check if all items listed on the delivery note, including the getting started manual, are included in the delivery.
- Check the R&S FPC for any damage.
If the contents are damaged, immediately contact the carrier who delivered the package.
- Keep the box and packing material.

NOTICE**Risk of instrument damage during transportation and shipment**

Insufficient protection against mechanical and electrostatic effects during transportation and shipment can damage the instrument.

- Always make sure that sufficient mechanical and electrostatic protection is provided.
- When shipping an instrument, use the original packaging. If it is not available, allow for sufficient padding to prevent the instrument from moving around inside the box. Pack the instrument in antistatic wrap to protect it from electrostatic charging.
- Secure the instrument to prevent any movement and other mechanical effects during transportation.

**Packing material**

Retain the original packing material. If the instrument needs to be transported or shipped later, you can use the material to protect the control elements and connectors.

3.2 Placing or Mounting the Instrument

The R&S FPC is designed for use under laboratory conditions, either on a bench top or in a rack.

Benchtop operation

If the R&S FPC is operated on a bench top, the surface should be flat. The instrument can be used in horizontal position, standing on its feet, or with the support feet on the bottom extended.

Mounting the R&S FPC in a rack

The R&S FPC can be installed in the 19" rack mount kit R&S ZZA-FPC1 (order no. 1328.7080.02). The installation instructions are part of the adapter kit.

⚠ CAUTION**Risk of injury if feet are folded out**

The feet can fold in if they are not folded out completely or if the instrument is shifted. This can cause damage or injury.

- Fold the feet completely in or out to ensure stability of the instrument. Never shift the instrument when the feet are folded out.
- When the feet are folded out, do not work under the instrument or place anything underneath.
- The feet can break if they are overloaded. The overall load on the folded-out feet must not exceed 200 N.

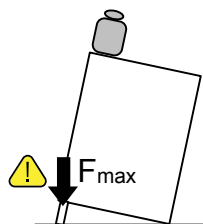

3.3 Connecting AC Power

The AC power connector on the rear panel of the R&S FPC allows you to connect it to the primary power supply.

Included in the delivery of the R&S FPC are several common power plug types.

1. Select the cable with the plug type you need and firmly connect it to the R&S FPC.
2. Connect the AC plug to the power outlet to supply the R&S FPC with power. The R&S FPC is assembled in line with the specifications for safety class EN61010. Therefore, it may only be connected to an outlet that has a ground contact.

The AC power supply has the following characteristics.

- Line voltage: 100 V AC to 240 V AC
- Line frequency: 50 Hz to 60 Hz; 400 Hz
- Current: 0.6 A to 0.4 A

3.4 Turning the R&S FPC on and off

After you have established a connection to the power supply, you can turn on the R&S FPC.

Turning on the R&S FPC

- ▶ Turn on the main AC power switch on the rear panel of the R&S FPC (position "I"). The instrument is now supplied with AC power.
 - "Power" key is highlighted orange: R&S FPC is in standby mode (main AC power switch is in position "I").
 - "Power" key is highlighted green: R&S FPC is running and ready for operation.

Turning off the R&S FPC

- ▶ Turn off the main AC power switch on the rear panel of the R&S FPC (position "O"). The instrument is no longer supplied with AC power.

Changing the AC supply fuse

Only fuses of the type 2A T IEC60127-2/V should be used.

1. Disconnect the power cable.
2. Open the flap covering the voltage selector using a small screwdriver (or similar).
3. Remove the cylinder labeled with the nominal voltages. Remove the fuse and install the new one. Reinsert the cylinder so that the value visible through the hole in the cover flap is the same nominal voltage as before.
4. Close the flap.

4 Instrument Tour

The R&S FPC has various connectors on the front and rear panel.

4.1 Front Panel

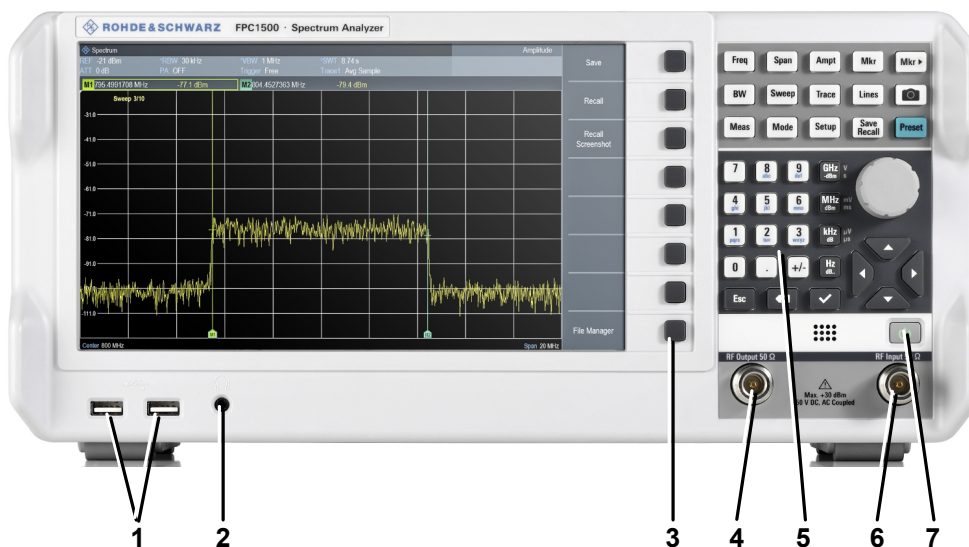

Figure 4-1: Front panel of the R&S FPC

- 1 = USB ports (type A)
- 2 = Headphone jack
- 3 = Softkeys
- 4 = Signal source output
- 5 = Function keys and alphanumeric keypad
- 6 = RF input
- 7 = Power switch

NOTICE

Instrument damage caused by cleaning agents

Cleaning agents contain substances such as solvents (thinners, acetone, etc.), acids, bases, or other substances. Solvents can damage the front panel labeling, plastic parts, or screens, for example.

Never use cleaning agents to clean the outside of the instrument. Use a soft, dry, lint-free dust cloth instead.

Power switch

The power switch turns the R&S FPC on and off when it is supplied with power.

For more information, see [Chapter 3.4, "Turning the R&S FPC on and off"](#), on page 13.

RF input

The RF input with an impedance of 50 Ω allows you to connect a DUT to the R&S FPC. Typically, you connect the DUT with a cable and an appropriate connector (for example a male N connector).

The frequency range of the RF input is specified in the datasheet.

The attenuation range is between 0 dB and 40 dB.

NOTICE

Risk of instrument damage

Make sure not to overload the RF input and keep within the maximum allowed signal levels. Refer to the datasheet for the maximum allowed signal levels.

A DC input voltage of 50 V must never be exceeded.

Signal source output

Available on the R&S FPC1500.

The "Signal Source" output allows you to generate a signal that can be fed into the DUT or other external accessories like frequency dividers or amplifiers. You can connect the DUT or accessories with a cable that has a male N connector.

NOTICE

Risk of instrument damage

The maximum supported reverse power is 23 dBm. Make sure that this value is not exceeded to avoid damage to the R&S FPC.

Headphone jack

The female headphone jack allows you to connect headphones (or external speakers) with a miniature jack plug.

You can control the output voltage with the volume control integrated into the firmware. Refer to the user manual for details.

If you connect headphones or external speakers, the R&S FPC automatically turns off the internal speaker.

CAUTION

Risk of hearing damage

Before putting on the headphones, make sure that the volume setting is not too high to protect your hearing.

USB ports (type A)

The two USB 2.0 ports on the front panel (type A) allow you to connect devices like memory sticks.

Function keys and alphanumeric keypad

The function keys provide access to the measurement settings and functions. The alphanumeric keypad allows you to enter alphanumeric data if necessary.

Refer to the user manual for a comprehensive description of the function keys.

Softkeys

The softkeys allow you to access measurement settings and functions.

Softkeys are dynamic. A different list of softkeys is displayed depending on the selected function key. A list of softkeys for a certain function key is also called a menu.

Softkeys can either perform a specific function or open a dialog box.

Refer to the user manual for a comprehensive description of the function keys.

4.2 Rear Panel



Figure 4-2: Rear panel of the R&S FPC

- 1 = Trigger input / external reference
- 2 = LAN
- 3 = USB port (type B)
- 4 = Power supply

Power supply

The AC power supply and main power switch are located in a unit on the rear panel of the instrument.

The main power switch has the following states.

- Position "1": The instrument is supplied with power.
- Position "0": The instrument is disconnected from the power supply.

Trigger input / external reference

This female BNC connector allows you to connect an external trigger signal or an external reference signal.

When you are using the connector as a trigger input, you can trigger measurements with an external trigger. For more information about triggered measurements, refer to the user manual.

Alternatively, you can use the connector to connect a 10 MHz reference signal to synchronize the frequency with the external reference. Note that the reference signal must be stronger than 0 dBm.

LAN

The LAN interface allows you to connect the R&S FPC to a local network for remote control, printouts or data transfer. The assignment of the RJ-45 connector supports twisted-pair category 5 UTP/STP cables in a star configuration (UTP stands for *unshielded twisted pair*, and STP for *shielded twisted pair*).

USB port (type B)

The USB port (type B) allows you to connect the R&S FPC to a computer and establish a remote control connection.

5 Operation

You can operate the R&S FPC manually with the keys available on its front panel, or remotely from another computer.

- [Manual Operation](#).....19
- [Screen Layout](#).....22
- [Remote Operation](#).....25

5.1 Manual Operation

The front panel of the R&S FPC provides various types of buttons (or keys) on its front panel that allow you operate it manually.

Using function keys

Function keys are the group of keys with a light grey background.



Figure 5-1: Function keys

Pressing one of the function keys opens a list of parameters on the display that contains settings that thematically belong together. This list of parameters is also referred to as a menu.

For example, pressing the "Freq" key opens the "Frequency" menu that contains parameters to configure the frequency characteristics of the measurement.

The contents of the menu depend on the measurement application that you are using.

For example, the "Frequency" menu in the spectrum application looks different than the "Frequency" menu of the analog demodulation application.

Exceptions are the "Preset" key and the camera key. These do not open a menu, but initiate an action (performing a preset and taking a screenshot, respectively).

You can modify a specific parameter (menu item) with one of the softkeys.

Using softkeys

Softkeys are the group of keys to the right of the display.

Pressing one of the softkeys allows you to modify the properties of the parameter that is displayed next to it. The parameter assigned to each softkey is variable and depends on the function key that you pressed last.

For example, when you press the "Freq" function key in the spectrum application, the first item in the menu is the "Center Frequency". When you press the softkey next to

that menu item, the R&S FPC opens an input field that allows you to change the center frequency.

Depending on the parameter, pressing a softkey has one of the following effects.

- It opens an input field that allows you to modify a parameter by entering a specific value. When an input field is open, the corresponding menu item turns orange. Example: Pressing the "Freq" key and selecting the "Center Frequency" menu item opens an input field.

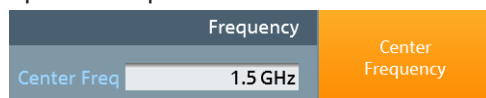

Figure 5-2: Softkey turns orange when an input field is open

Pressing the softkey again, closes the input field. If you have changed the value in the input field, the new value is adopted.



Figure 5-3: Softkey turns grey when the input field is closed

- It opens a submenu which contains another list of parameters that thematically belong together. A softkey that opens a submenu shows an arrow (">") in its label. Example: Pressing the "Freq" key opens the "Frequency" menu. The second softkey in the list ("Center Freq Step Size") opens a submenu.



Figure 5-4: Softkey with an arrow opens a submenu

- It initiates some kind of action. Example: Pressing the "Span" key and selecting the "Full Span" menu item restores the full frequency span.
- It changes the state of something (like a toggle button). The corresponding menu item turns light blue when its state is "on". Example: Pressing the "BW" key and selecting the "RBW: Auto" menu item turns automatic selection of the resolution bandwidth on and off.



Figure 5-5: Softkey in the "on" (left) and "off" (right) state

- It opens a dialog box that contains additional settings. Example: Pressing the "Setup" key and selecting the "Instrument Setup" menu item opens a dialog box to configure general instrument properties like date and time.

Using input keys



Input keys are the group of keys with a dark grey background.



Figure 5-6: Input keys

The input keys only have an effect when any kind of input field is active on the display.

There are several types of input keys.

- **Alphanumeric keys**
 The alphanumeric keys allow you to enter numeric values or characters: the numbers from 0 to 9, the alphabet, a minus and plus sign and a dot. Pressing the number 0 repeatedly allows you to enter an empty space and an underscore. Press the corresponding key to enter a numeric value. In case of numeric values, each key covers just the number that is printed on it. You can enter negative values with the minus sign key and enter values that contain decimal places with the dot key.
 Example: Press the "Freq" key and select the "Center Frequency" menu item. Enter a number with the alphanumeric keys.
 If you need to enter a character (for example for file names), the key assignment changes. Each key covers one number and more than one character with the first choice being a lower case character. If you need to enter a character, press the key several times until the character you require is selected.
 Example: Press the "Freq" key and select the "User Preference" menu item. In the dialog box, select the "Site Name" menu item and enter some characters (for "Home", for example, press 6x"4", 3x"6", 1x"6" and 2x"9").
 An empty space or special characters like _ ! @ # \$ % ^ & * = ? are available by pressing the "0" key several times.
- **Unit keys**
 The unit keys confirm entries of values that have a unit. The units assigned to each key are indicated on the key itself or next to the key.
 Example: Press the "Freq" key and select the "Center Frequency" menu item. To define a center frequency of 100 MHz, enter "100" and confirm with the [MHz] key.
- **Escape key**
 The "Esc" key cancels entries and closes the input field. The firmware does not adopt the entry you have made.
- **Backspace key**
 The "Backspace" key () moves the cursor one position backwards and deletes the character / number that was in that place.
Tip: If an input field is visible, the backspace key toggles between the last two entries. Using this feature, you can, for example, quickly toggle between two center frequencies.
- **"Enter" key ("")**
 The "" key confirms an entry you have made.

If you confirm a value that has a unit with the "✓" key, the R&S FPC always uses the highest possible unit (for example GHz or s).

In addition, the group of input keys also contains cursor keys and the rotary knob.

Using the cursor keys

The cursor keys do several things, depending on the situation when you use them.

- The cursor keys navigate through dialog boxes.
- The up and down keys increase or decrease any kind of numeric value if an input field is active.
The cursor keys change numeric values with a fix step size.
- The up and down keys move markers around.
The step size is fix.
- The left and right keys move the cursor in an input field in the corresponding direction.

Using the rotary knob

The rotary knob does several things, depending on the situation when you use it.

- The rotary knob works like a cursor key in dialog boxes. In that case, you can navigate to one of the items with the rotary knob. If the dialog box covers more than one screen page, it also scrolls through the dialog box.
Turning it to the right corresponds to a downward movement. Moving it to the left to an upward movement.
- The rotary knob increases or decreases any kind of numeric value if an input field is active.
Turning it to the right corresponds to an increase, turning it to the left to a decrease of a numeric value.
The rotary knob changes numeric values with a fix step size.
- The rotary knob moves markers around in the diagram area.
To do so, you have to select a marker first. The step size is fix.
- Pressing the rotary knob has the same effect as pressing the "✓" key and confirms an entry or selection.

5.2 Screen Layout

The following image shows the screen layout in the spectrum application. It shows all elements that are the same in all applications of the R&S FPC. If an application or measurement has a completely different layout or elements, the differences are noted in the description of those.

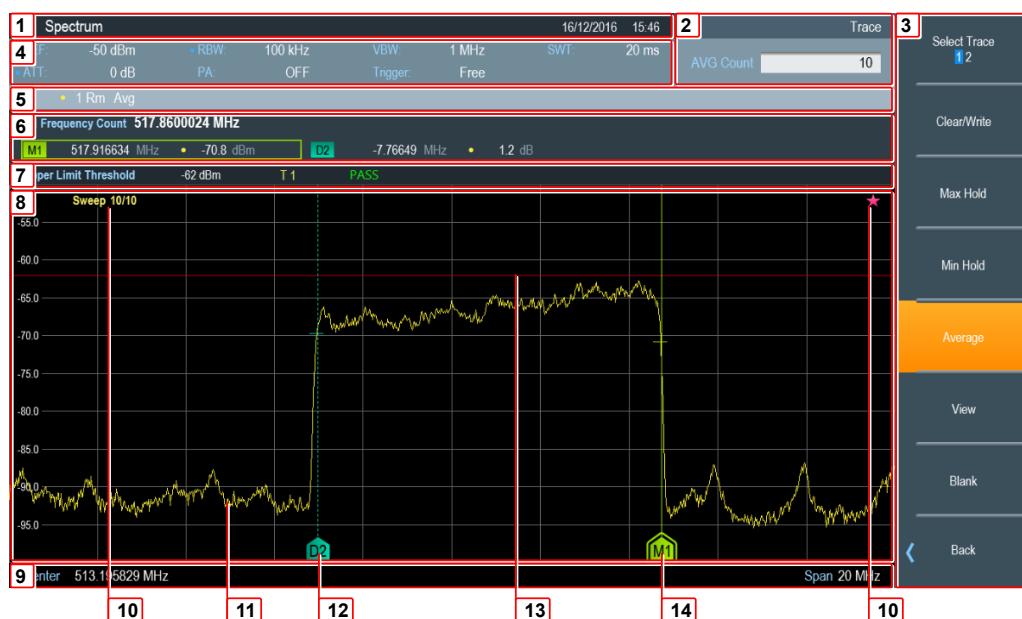

Figure 5-7: Screen layout in the spectrum application

- 1 = Title bar
- 2 = Input field
- 3 = Softkeys
- 4 = Measurement settings
- 5 = Trace information
- 6 = Marker information
- 7 = Limit line information
- 8 = Diagram area
- 9 = X-axis information
- 10 = Sweep count
- 11 = Trace
- 12 = Delta marker
- 13 = Limit line
- 14 = Marker
- 15 = Star icon

Title bar

The title bar shows the application that you are currently using as well as the date and time.

Input field

An input field opens when you select a feature that requires you to enter a value. The header of the input field shows the name of the softkey menu you have currently selected. If no input field is open, the R&S FPC just shows the name of the softkey menu you have currently selected.

Softkey menu

Softkeys provide access to measurement settings and functions. They are dynamic: a different list of softkeys is displayed depending on the selected function key. A list of softkeys for a certain function key is also called a menu.

Softkeys can either perform a specific function or open an input field or dialog box.

Measurement settings bar

The measurement settings bar contains information about the current measurement settings. A blue dot in front of a setting indicates that automatic selection for that setting has been turned off.

Trace information

The trace information indicates the current trace configuration for each active trace (trace color, [trace number](#), [trace mode](#) and [detector](#)).

Table 5-1: Overview of trace modes

Abbreviation	Detector
ClrW	Clear / write trace mode
Max	Max hold trace mode
Min	Min hold trace mode
Avg	Average trace mode
View	View trace mode
No label	Blank trace mode (trace is off)

Table 5-2: Overview of detectors

Abbreviation	Detector
AP	Auto peak detector
Pk	Max peak detector
Mi	Min peak detector
Rm	RMS detector
Sa	Sample detector
QP	Quasipeak detector (receiver only)

Marker information

The marker information indicates the position of each active [marker](#). If a marker function is active, it also shows the result for that marker function.

Limit line information

The limit line information indicates the characteristics of any active [limit line](#) (type of limit line, name of limit line etc.), including the result of a limit check (pass or fail).

Diagram area

The diagram area contains the graphical representation of the measurement results.

The diagram area can contain additional information.

- The sweep count indicates the process of **trace averaging**. The first number is the current measurement, the second number the total number of measurements included in the trace averaging.
- The trace indicates the characteristics of the measured spectrum.
- The position of **markers or delta markers** is indicated by a straight horizontal line (markers) or a dotted line (delta markers). In addition, the marker position is also indicated by an icon at the bottom of the diagram area.
- The position and shape of a **limit line** is indicated by a red vertical line.
- The star icon (★) indicates that the displayed results no longer correspond to the current measurement settings. The star will appear, for example, when you change settings after a single measurement is done.

X-axis information

The x-axis information indicates the current scale and range of the x-axis.

5.3 Remote Operation

There are various tools that allow you to operate the R&S FPC remotely from another computer (for example PC or tablet).

To use the R&S FPC this way, you have to establish a connection between both devices via the LAN, Wi-Fi or USB interfaces of the R&S FPC.

Remote desktop (R&S InstrumentView)

R&S InstrumentView is a software that contains various useful tools, including a remote desktop application. You can download the software, including a user manual, from the Rohde & Schwarz website.

1. Install the software on a desktop PC or notebook.
2. Connect the R&S FPC to the computer with a LAN cable or a USB cable.
3. Start the software on the computer (use the desktop icon, or search for "InstrumentView" in the start menu).
4. Establish a connection to the R&S FPC in the "Connection Manager".
 - a) Select the "LAN" tab to configure the LAN properties.



- b) Select the pencil icon (✎).
- c) Enter the **IP address** of the R&S FPC you want to connect to.
- d) Confirm with the "Connect" button.

You can connect to as many instruments as you like (including other supported instruments like R&S FSH or R&S FPH). To do so, simply "Add Another Device" and define the network properties for them.

Alternatively, you can establish a connection via USB in the "USB" tab of the "Connection Manager".

5. Select "Instrument" > "Remote Display".

The software shows a live simulation of the R&S FPC, including all keys available on the front panel.

Everything you do in the remote desktop application is also done on the connected R&S FPC.

For a comprehensive description of the R&S InstrumentView software, refer to its user manual.

Tip: Lab display. The lab display allows you to access several instruments at the same time via the remote desktop. For more information, refer to the documentation of the R&S InstrumentView software.

Remote desktop (R&S MobileView)

R&S MobileView is an app that allows you to remote control the R&S FPC from a tablet or smartphone. It basically works like the remote desktop application built into the R&S InstrumentView software.

You can download the app from the Google Play Store (Android based devices) or the AppStore (iOS devices). A search for "Rohde Schwarz MobileView" should find the app.

1. Start the R&S FPC.
2. Configure your tablet or phone as a hotspot for an ad-hoc connection (usually in the phone settings).
3. Connect the R&S FPC to the mobile device.
 - a) Press the "Setup" key to open the instrument setup menu.
 - b) Select "WiFi": "On" to turn on the Wi-Fi functionality.
 - c) Select the "Connect" menu item to start a search for Wi-Fi networks in the area.

The R&S FPC starts a search for all Wi-Fi networks it can find (mobile devices, routers etc.).
 - d) Select the network you want to connect to.
 - e) Enter the password of the network with the alphanumeric keys. The network password should be displayed in the hotspot settings of the mobile device.

The R&S FPC establishes the connection.
4. Start the R&S MobileView app on your mobile device.

The app shows a list of all R&S FPC devices that are connected to the hotspot.
5. Select the R&S FPC you want to connect to.

The app shows a live simulation of the R&S FPC, including all keys available on the front panel.

Everything you do in the app is also done on the connected R&S FPC.

Note: If you have a device that does not support ad-hoc connections, you have to connect both devices to an existing wireless infrastructure (for example through a router). When you connect both the mobile device and the R&S FPC to the infrastructure, you can use the app just like with an ad-hoc connection.

Remote operation (SCPI commands)

Remote operation with SCPI commands is a method to automate measurements by writing scripts or programs that contain all instructions required for the measurement. When you start the program, the measurement is done automatically from start to finish. Manual configuration of a measurement with function keys, softkeys or apps is no longer necessary.

Remote operation is thus a useful tool for measurements that you perform repeatedly and for which you know the configuration and for which the configuration is always the same. Testing devices during production is an example for such measurement tasks. Each device needs to be tested under the same conditions.

You can operate an instrument remotely using SCPI commands (Standard Commands for Programmable Instruments). Sending a SCPI command initiates one or more actions on the instrument, for example change the state of a parameter or start a measurement. Usually, each parameter available in the firmware has a corresponding SCPI command.

Example: The SCPI command to change the center frequency is
`[SENSe:] FREQuency: CENTer.`

When you send a succession of these commands, you can configure and perform complete measurements.

There are several tools that allow you to connect to an instrument, send an individual (or more) command(s) and compile automated test sequences.

One of these tools is delivered with the R&S VISA library that is available for download on the Rohde & Schwarz website (search term: "r&s visa"). The VISA library itself provides input and output functions that are required to communicate with the instrument.

Another tool with more complex scripting functions is R&S Forum, also available for download on the Rohde & Schwarz website (search term: "forum"). It allows you to run and edit example script sequences and to write your own script files, as well as on-the-fly remote control of instruments. Script files can range from simple command sequences (Winbatch syntax) to complex programs using the programming language Python.

User documentation and background information is available for both tools. If you want to learn more about their features, refer to the corresponding user manuals and application notes.

The following basic introduction to remote control is based on the tool that is delivered with the R&S VISA.

1. Install R&S VISA on a desktop PC or notebook.
2. Connect the R&S FPC to the computer with a LAN cable or a USB cable.
3. Start the RsVisaTester software (search for "tester" in the start menu). Use the 32-bit or 64-bit version, depending on your operating system.

The user interface of the RsVisaTester opens.

4. Establish a connection to the R&S FPC.
 - a) In the "Resource" field, enter the [IP address](#) of the R&S FPC you want to connect to.
The form is `tcpip::[::protocol][::instrument]`, you can leave out the parts in brackets for now. Just enter `tcpip::`.

- b) Confirm the entry with the "Connect" button.

After a successful connection, you can see in the left pane that the software already sent the commands necessary to open the connection.

5. Enter a command in the input field in the "Basics" tab, for example `*idn?` (make sure to add the question mark). Then select the "Query" button.

The `*IDN?` (identity) command queries information about the connected product. In this case, it should return a string similar to this:

`Rohde&Schwarz,FPC1000,1328.6660K02/111111,1.00.`

"Query" button: whenever you want to retrieve information from the instrument (query), use this button.

Tip: See [Chapter 19.1, "Remote Control Basics"](#), on page 187 for a comprehensive description about the remote command syntax and the ways you can send a command.

6. For the following command sequence, make sure that the spectrum application is the active one.
Enter the command `instrument:select spec`. Then select the "Write" button.
The command selects the spectrum application.
7. At the beginning of a command sequence, you should always preset the instrument settings to their default values. You can do a preset with the `*RST` command. Enter the command in the input field and select the "Write" button.

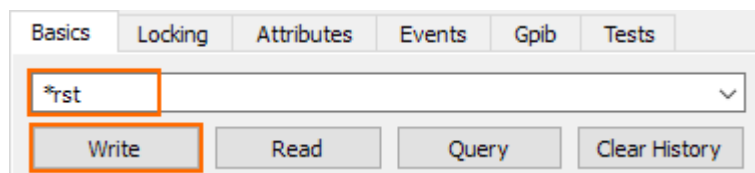

The R&S FPC resets the settings to their default value.

"Write" button: whenever you want to send information to the instrument, use this button.

- Enter another command, one that changes an instrument setting, for example `sense:frequency:center 100mhz` or the short form `freq:cent 100MHZ`. Then select the "Write" button.

The new state of the setting you want to change is defined by a parameter that you add behind the command.

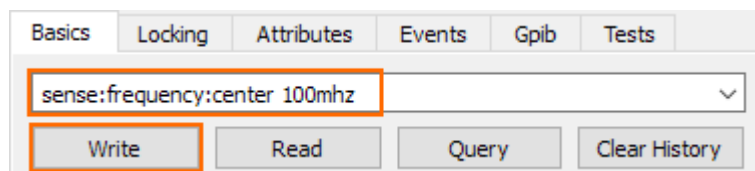

The `SENSe:FREQuency:CENTer` command changes the center frequency of the R&S FPC.

After a preset, the center frequency is half of the supported frequency range (500 MHz for 1 GHz instruments).



When you send the command, the center frequency changes to 100 MHz. You can observe this change on the instrument display.



- Send the command again, this time as a query. To query the state of a setting, add a question mark instead of a parameter (`sense:frequency:center?`). Then select the "Query" button.

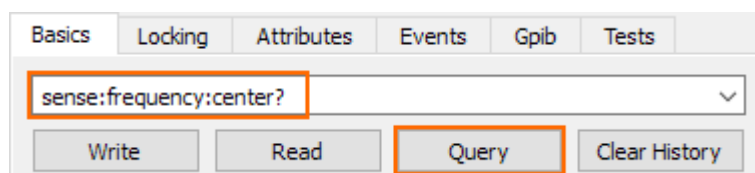

The command returns the current state of the parameter you have queried (in this example the return value should be 100 MHz as you have just changed it to that value).

sense:frequency:center?

Write Read Query Clear History

Send End

100000000.000000

Note that unless stated otherwise, a query always returns a numeric value in the SI derived unit (Hz in case of a frequency, not in kHz, MHz or GHz) and with several decimal places (usually six).

Commands like `SENSE:FREQUENCY:CENTER` work a setting and a query. Other commands do not work both ways. `*IDN`, for example, is only allowed as a query (setting anything is not possible). `*RST`, for example, is only allowed as a setting (a query is not possible). Information about how you can use command is included in the command description.

10. Send a succession of commands to measure the spectrum around the center frequency of 100 MHz.
 - a) `initiate:continuous off`

Basics Locking Attributes Events Gpib Tests

initiate:continuous off

Write Read Query Clear History

This command selects single sweep mode, recommended for remote measurements.

- b) `initiate:immediate;*wai`

Basics Locking Attributes Events Gpib Tests

initiate:immediate;*wai

Write Read Query Clear History

You can write two commands into one command line, but have to separate them with a semicolon (;). The first command (`INITiate:IMMediate`) initiates the measurement. The second command (`*wai`) instructs the program to wait until the preceding command (`INITiate:IMMediate`) has been executed before any subsequent commands are sent. This synchronization to the end of the measurement is important, because it makes sure that the measurement is done before taking another action.

11. When the measurement is done, you can query the measurement results (trace data).
Send the query `trace:data? trace1` to do so.

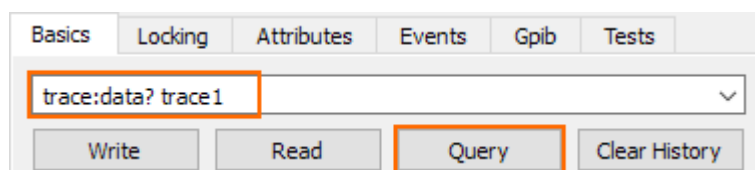

TRACe:DATA is a query, but you have to state a parameter in that case. The parameter defines which data is returned (in this case, the data of trace 1; you could also display a second trace whose data you could query with TRACe:DATA TRACE2).

The trace data contains 1183 level values (one value for each pixel of the display). The unit of the values is dBm. The values are shown in the message box of the user interface.

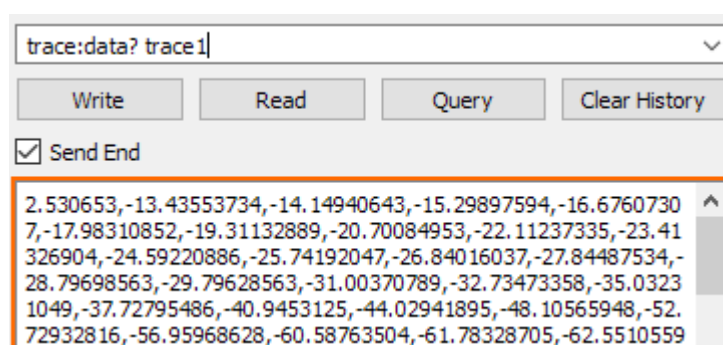

You can copy the trace data from the message box and paste it into a text file, spreadsheet etc. for further evaluation. (There are also SCPI commands that automatically copy that data into a file, so you do not have to do that manually.)

Tip: Logging commands. You can save all commands you have sent with RsVisa-Tester into a log file (.txt file type) and reuse it later on.

To do so, turn on the "Write Log" feature and select a folder to save the file in ("Change Log File" menu item).

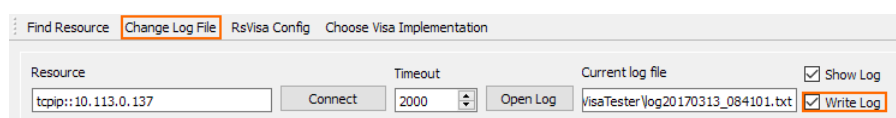

Figure 5-8: Logging feature in the VISA tester application

This was a short example of how to use SCPI commands to measure a signal. Depending on your measurement task you can expand the succession of commands as you like, write it into a script and automate a measurement.

6 Firmware Update

New firmware versions usually contain new features, improvements of existing functionality, bug fixes etc. When a new firmware version is available, it is recommended to replace the old firmware with the new one.

Updating the firmware

The latest firmware version is available for download on the internet:

www.rohde-schwarz.com/firmware/fpc



Before you update the firmware, you should make a backup of the data that you have stored on the R&S FPC (datasets, screenshots, transducer factors etc.). You can make a backup with the tools available in the R&S InstrumentView software package.

The firmware update itself does not delete or modify that data, but it is recommended to perform a factory reset after the firmware update to update predefined limit lines, channel tables etc. The factory reset, however, does delete user data.

1. Download the firmware installer from the internet.
The firmware comes in a single `.exe` file.
2. Save the file to the root directory of a memory stick.
3. Run the `.exe` file to unpack the self-extracting zip archive.

The following files are extracted.

- `FPC_bootloader_<version>.bin`
- `FPC_osimage_<version>.bin`
- `FPC_updater_<version>.bin`
- `FPC_xmegaloadfiles_<version>.bin`

Make sure that only these files are present in the root directory of the memory stick.

4. Turn off the R&S FPC.
5. Connect the memory stick to one of the USB interfaces of the R&S FPC.
6. Press the "Preset" key and the number "8" key simultaneously.



7. Turn on the R&S FPC and keep pressing the two keys for at least 5 seconds after the startup screen appears.
8. Release the keys.

The booting process continues. After a couple of seconds, the R&S FPC asks you if you really want to update the firmware.

9. Press the "Enter" ("✓") key to update the firmware.
(You can cancel the firmware update with the "Esc" key.)

The firmware update takes several minutes. The R&S FPC shows a message when the firmware update is done.

Note: Do not turn off the R&S FPC during the firmware update.

10. Turn off the R&S FPC.
11. Turn on the R&S FPC.

The R&S FPC boots with the new firmware version.

12. Optional: It is recommended to perform a [factory reset](#) after a firmware update to replace the predefined limit lines, channel tables and other data with the latest updates.

Note: Before you start a factory reset, make sure to make a backup of your data that you have saved on the R&S FPC. Otherwise that data is deleted.

7 Firmware Options

You can equip the R&S FPC with optional functionality or firmware options like the analog demodulation application or the receiver application. These firmware options expand the functionality of the R&S FPC with new measurement functions settings etc.

Installing firmware options

To install a new firmware option, you have to enter a license key for validation.

The license key is included in the delivery of the firmware option.

1. Press the "Setup" key to enter the instrument setup menu.

2. Select the "Installed Options" menu item.

The R&S FPC shows a list of all options that are currently installed on your R&S FPC.

3. Select the "Install Option" button and press the "Enter" key.

The R&S FPC opens an input field.

4. Enter the license key with the alphanumeric keys and confirm the entry with the "Enter" key.

The license key is a 32-digit number.

The R&S FPC confirms a successful installation.

If the R&S FPC shows an "Invalid Key Code" message, try to enter the license key again.

Using the R&S LicenseManager (online registration)

You can use the R&S License Manager to manage options with a web browser (Microsoft Internet Explorer, Mozilla Firefox etc.) from a PC.

To use the R&S License Manager, you have to connect the R&S FPC to a local area network (LAN). See [Chapter 9.2, "Network Configuration"](#), on page 39 for more information about how to connect the R&S FPC to a LAN.

After you have connected the R&S FPC, open the web browser.



Make sure to allow the execution of mixed-mode scripts, for example allow in Google Chrome the loading of scripts from unsafe sources.

► Enter the IP address of the R&S FPC in the address bar of the web browser.

A screenshot of a web browser address bar showing the IP address 192.0.2.0. The address bar has a small blue icon on the left and a text input field containing the IP address.

The web browser opens the R&S License Manager. In this part of the R&S License Manager, you can install, activate and register licenses on the R&S FPC.

This page contains three areas.

- The first area shows the details of the connected device, including the device ID and the IP address.

Connected Device

FPC1000	Device ID:	1328.6660K02-██████████
FPC1000	IP Address:	10.11██████████
Version: 1.05	Host Name:	localhost

- The second area provides functionality to install and activate licenses.

What do you want to do?

- [Install Registered License Keys and Activate Licenses](#) ⓘ
- [Register Licenses, Install License Keys and Activate Licenses](#) ⓘ
- [Reboot Device](#) ⓘ

- "Install Registered License Keys And Activate License"
Follow this link if you have purchased a registered license. Registered licenses only work in a combination with a specific device ID.
- "Register License, Install License Keys and Activate Licenses"
Follow this link if you have purchased an unregistered license. Unregistered licenses are not linked to a specific device ID.
- "Reboot Device"
Follow this link to reboot the R&S FPC.
- ⓘ
Opens an online help of the corresponding topic.

- The third area provides hints on using the license manager when you move the mouse over one of the options.

Help



Install Registered License Keys and Activate Licenses:

A registered license must be activated on a specific Rohde & Schwarz device, in order to enable functions which are covered by the license. Use "Install Registered License Keys and Activate Licenses" to activate such licenses. You will be requested to enter registered license ID of the target device.

The R&S License Manager also provides functionality to managed licenses of options that you have already installed on a R&S FPC.

- ▶ Select the "Manage Licenses" button.

The web browser opens another part of the R&S License Manager. In this part of the R&S License Manager, you can manage licenses already installed on your R&S FPC.

This page contains two areas.

- The first area provides functionality to manage licenses.
 - "Register Licenses"

Follow this link if you have purchased an unregistered license and want to register it.

- "Unregister License"
Follow this link if you have installed a portable license. Portable licenses can be used with several device IDs. However, you have to unregister it on one device before you can use it on another.
- "Move Portable License"
Follow this link if you want to move a portable license. Moving a portable license is possible without unregistering the license.
- 
Opens an online help of the corresponding topic.
- The second area provides hints on using the license manager when you move the mouse over one of the options.

After you have followed one of the links, follow the instructions displayed in the web browser. If you encounter any issues during the licensing procedure, you can access the online help at any time with the  icon. The online help contains an extensive description of all functionality that the license manager features.

8 Preset

Access: "Preset"

Access (preset configuration): "Setup" > "User Preference"

Access (factory reset): "Setup" > "Instrument Setup"

Remote commands required to preset the system:

- [Chapter 19.3, "Preset"](#), on page 206

Before you prepare a measurement, it is recommended to preset the R&S FPC. During a preset, the R&S FPC resets all settings to their default state. Restoring the default configuration has the advantage that old settings do not affect measurements.

The default setup depends on the application you are using.

Presetting the system

1. Press the "Preset" key to restore the default instrument configuration.
You can also define your own default settings via a dataset. The R&S FPC restores the configuration stored in the dataset after you press the "Preset" key instead of the factory defaults.
2. Press the "Setup" key to open the setup menu.
3. Select the "User Preference" menu item to open the user preference dialog box.
4. Select the "Preset Mode" menu item to select the preset mode.
 - "Default"
Restores the factory default configuration.
 - "User"
Restores custom default values taken from a dataset. In that case, you have to select a dataset that contains the default values.
5. Select the "Preset Dataset" menu item to select a dataset.
When you preset the R&S FPC, it applies the configuration of the dataset. For more information about the "Discard Calibration Data" menu item, see ["Performing a default calibration"](#) on page 56.

In addition to the preset, you can also reset the system to the condition it had when it was delivered (factory reset).



Potential data loss

Note that when you reset the R&S FPC to the factory state, all files you have saved on the internal memory of the R&S FPC will be deleted. Only the files that were included in the delivery will be kept.

Resetting the system

1. Press the "Setup" key to open the setup menu.

2. Select the "Instrument Setup" menu item to open the setup menu.
3. Select the "Reset To Factory Settings" menu item.
The R&S FPC initiates the reset process and will ask you to confirm the reset.
When you select "Yes", the system will be reset.

9 Instrument Setup

Access: "Setup" > "Instrument Setup"

The "Instrument Setup" dialog box contains general properties of the R&S FPC that are independent of the measurement application you are using.

• BNC Connector Usage	39
• Network Configuration	39
• Date and Time	41
• Regional Settings	42
• Display Settings	43
• Audio Settings	43
• Power Settings	44

9.1 BNC Connector Usage

Remote commands required to configure the BNC connector:

- [Chapter 19.5, "System Configuration"](#), on page 209

You can use the BNC connector on the rear panel of the R&S FPC for several applications. Before you can use it in the corresponding way, you have to configure it accordingly.

Selecting the BNC connector usage

1. Press the "Setup" key to open the setup menu.
2. Select the "Instrument Setup" menu item to open the instrument setup dialog box.
3. Select the "BNC" menu item in the "Hardware" category.
4. Select one of the menu items.
 - "Trigger Input"
You can connect an [external trigger source](#) and trigger measurements.
 - "Reference Input"
You can connect an external frequency reference and synchronize the frequency of the R&S FPC with the external reference.

9.2 Network Configuration

Remote commands required to configure the network properties:

- [Chapter 19.4, "Network Connection"](#), on page 207

You can connect the R&S FPC to a local area network (LAN) with a standard LAN cable. Alternatively, you can connect the R&S FPC to a wireless LAN (WLAN or WiFi). This is useful, for example, for remote control operation or if you would like to control the R&S FPC with the R&S InstrumentView software package.

LAN

When you are connecting the R&S FPC to a wired network (LAN), connect the R&S FPC with a standard LAN cable to a LAN port. The LAN port of the R&S FPC is on its rear panel.

In case of a wired connection, you have to define several network properties to establish a network connection.

You can either fetch the R&S FPC network properties automatically from a DHCP server (Dynamic Host Configuration Protocol) or manually assign a fixed address. With manual allocation, a fixed IP address and subnet mask must be assigned to the R&S FPC.



MAC address

The MAC address is the unique identifier of the network adapter built into the R&S FPC.

You can see the MAC address of your R&S FPC in a read-only field in the "LAN" category of the "Instrument Setup" dialog box.

Using a DHCP server

In networks with a DHCP server, the network automatically allocates the network properties (IP address, subnet mask and gateway).

1. Press the "Setup" key to open the setup menu.
2. Select the "Instrument Setup" menu item to open the instrument setup dialog box.
3. Select the "DHCP" menu item in the "LAN" category.
4. Select "On" to activate DHCP.

The R&S FPC automatically writes the network properties in the corresponding fields ("IP Address", "Subnet Mask" and "Gateway"). This can take several seconds.

Connecting the R&S FPC to a LAN

If you want to configure the network properties manually, you need a free IP address in your network that you can assign to your R&S FPC. Kindly ask your IT system administrator to provide you with an unused IP address (and the other network information you need).

1. Press the "Setup" key to open the setup menu.
2. Select the "Instrument Setup" menu item to open the instrument setup dialog box.
3. Select the "DHCP" menu item from the "LAN" category.
4. Select "Off" to deactivate DHCP.

When you turn off DHCP, you can define the "IP Address", "Subnet Mask" and "Gateway" in the corresponding input fields.

Connecting the R&S FPC to a WLAN

Instead of connecting to a LAN, you can also connect the R&S FPC to a Wi-Fi network.

You can use the Wi-Fi functionality to connect the R&S FPC to a hotspot (for example a router or mobile device configured as a hotspot) and operate it remotely.

1. Press the "Setup" key to open the setup menu.
2. Select the "Instrument Setup" menu item to open the instrument setup dialog box.
3. Turn on the Wi-Fi functionality with the "WiFi" menu item in the "WiFi" category.
4. Select the "Scan WiFi Networks" menu item from the "WiFi" category.

The R&S FPC opens a dialog box that contains a list of all available Wi-Fi networks.

5. Select the network you would like to connect to.

The R&S FPC asks you to enter a password to access the network.

(In case of an open or public Wi-Fi, a password is not required. Using an open Wi-Fi poses security risks, however, so be cautious when connecting to an open Wi-Fi.)

6. Enter the password of the Wi-Fi network.

Tip: Regulatory information. You can view all regulations the R&S FPC complies with by selecting the "Regulatory Information" menu item.

9.3 Date and Time

Remote commands required to configure the date and time:

- [Chapter 19.5, "System Configuration"](#), on page 209

The R&S FPC has an internal system clock. A time stamp is added to various applications (for example when you create a file like a screenshot).

Setting the date

1. Press the "Setup" key to open the setup menu.
2. Select the "Instrument Setup" menu item to open the instrument setup dialog box.
3. Select the "Set Date" menu item in the "Date and Time" category.

4. Enter the date you want with the numeric keys.

The sequence depends on the [date format](#) you have selected.

If you enter an invalid date, the R&S FPC highlights the invalid part and does not accept the input until you enter a valid date.

Setting the system time

1. Press the "Setup" key to open the setup menu.

2. Select the "Instrument Setup" menu item to open the instrument setup dialog box.
3. Select the "Set Time" menu item in the "Date and Time" category.
4. Enter the time you want with the numeric keys.
If you enter an invalid time, the R&S FPC highlights the invalid part and does not accept the input until you enter a valid time.

Selecting a time zone

The displayed time represents the system time (UTC by default). If you need to create a different time stamp without changing the system time, you can define an offset that is added or subtracted to the system time.

1. Press the "Setup" key to open the setup menu.
2. Select the "Instrument Setup" menu item to open the instrument setup dialog box.
3. Select the "Time Zone" menu item in the "Date and Time" category.
4. Enter the time offset you want with the numeric keys.

Note: We recommended that you select the time zone before you define the system time.

9.4 Regional Settings

Remote commands required to configure regional settings:

- [Chapter 19.5, "System Configuration"](#), on page 209

Selecting the user interface language

The R&S FPC supports several user interface languages. When you change the language, all user interface elements that contain text are translated into the corresponding language.

Note that the "Language" menu item remains English, regardless of the language you select.

1. Press the "Setup" key to open the setup menu.
2. Select the "Instrument Setup" menu item to open the instrument setup dialog box.
3. Select the "Language" menu item in the "Regional" category.
4. Select the language of your choice.

Selecting the date format

The date format defines the way that the date is displayed.

1. Press the "Setup" key to open the setup menu.
2. Select the "Instrument Setup" menu item to open the instrument setup dialog box.

3. Select the "Date Format" menu item in the "Regional" category.
4. Select the date format of your choice.
 - "dd/mm/yyyy": day/month/year
 - "mm/dd/yyyy": month/day/year

Selecting the length unit

1. Press the "Setup" key to open the setup menu.
2. Select the "Instrument Setup" menu item to open the instrument setup dialog box.
3. Select the "Length Unit" menu item in the "Regional" category.
4. Select the length unit of your choice.
 - "Meter": metric length unit
 - "Feet": imperial length unit

9.5 Display Settings

Remote commands required to configure the display:

- [Chapter 19.6, "Display Settings"](#), on page 215

Adjusting the display backlight

The display backlight defines the brightness of the display.

You can adjust the backlight intensity of the display to get a good viewing experience depending on the lighting conditions of your surroundings.

1. Press the "Setup" key to open the setup menu.
2. Select the "Instrument Setup" menu item to open the instrument setup dialog box.
3. Select the "Display Backlight" menu item in the "Display" category.
4. Select the backlight intensity that you prefer.

The backlight intensity is a percentage from 0 % to 100 % with 100 % being the brightest.

9.6 Audio Settings

Remote commands required to configure the audio output:

- [Chapter 19.7, "Audio Settings"](#), on page 215

Defining the key click volume

The key click volume defines the volume of the sound that the R&S FPC produces when you press a key or softkey.

1. Press the "Setup" key to open the setup menu.
2. Select the "Instrument Setup" menu item to open the instrument setup dialog box.
3. Select the "Key Click Volume" menu item in the "Audio" category.
4. Select the volume that you prefer.
The volume is a percentage from 0 % to 100 % with 100 % being the loudest.

Defining the system beeper volume

The system beeper volume defines the volume of the system beeper. The system beeper produces a sound, for example, if a message box turns up.

1. Press the "Setup" key to open the setup menu.
2. Select the "Instrument Setup" menu item to open the instrument setup dialog box.
3. Select the "System Beeper Volume" menu item in the "Audio" category.
4. Select the volume that you prefer.
The volume is a percentage from 0 % to 100 % with 100 % being the loudest.

Turning audio output in case of a power overload on and off

If the R&S FPC detects an overload at one of its inputs, you can configure it to make a sound.

1. Press the "Setup" key to open the setup menu.
2. Select the "Instrument Setup" menu item to open the instrument setup dialog box.
3. Select the "Beep On Power Overload" menu item in the "Audio" category.
4. Select the setting you prefer.
If on, the R&S FPC makes a sound every time it detects an overload.

9.7 Power Settings

Turning automatic system boot on and off

1. Press the "Setup" key to open the setup menu.
2. Select the "Instrument Setup" menu item to open the instrument setup dialog box.
3. Select the "Auto Power Up On AC" menu item in the "Power" category.
4. Select the setting of your choice.

- "On": The R&S FPC automatically boots when you use the main power switch on the rear panel.
- "Off": After using the main power switch, the R&S FPC is in stand-by mode. You have to turn it on with the power button on the front panel.

10 Data Management

Access (save and recall datasets): "Save Recall"

Access (file manager): "Save Recall" > "File Manager"

Access (user preferences): "Setup" > "User Preferences"

Remote commands required for data management:

- [Chapter 19.8, "Data Management"](#), on page 216

The R&S FPC provides several tools to manage data related to your measurement tasks. Data related to measurements can come in different forms and formats, like limit lines, channel tables, specific measurement setups, measurement results or screenshots. All this data is usually stored in a file whose characteristics and file extension depend on the data type. Channel tables, for example, are stored in files with the extension `.chntab` while measurement configurations are stored in files with the extension `.set`.

Some data types like limit lines, transducer factors or channel tables, should already be available before you perform a measurement (for example limit lines, transducers or channel tables). This data is also referred to as templates. Other data types like measurement setups or screenshots are only created during the measurement or when the measurement is done. This data is also referred to as datasets.

Templates and datasets

Templates are measurement or analysis tools that you usually apply to measurement and that have an effect on the measurement results. A typical template that you might use regularly is a limit line or transducer factor. The R&S FPC already provides several predefined templates. If you need to create custom templates, you have to use the R&S InstrumentView software package.

Templates come in different forms and formats. Each type of template thus has a different file extension. Examples: `.chntab` (channel table), `rellim`, `abslim` (relative and absolute limit lines) or `pritr` and `sectrd` (primary and secondary transducer factors).

You can load templates into a measurement in the corresponding context menus.

- Loading limit lines: see [Chapter 14.12, "Limit Lines"](#), on page 130.
- Loading channel tables: see [Chapter 14.3.3, "Channel Tables"](#), on page 97.
- Loading transducer factors: see [Chapter 14.4.4, "Transducers"](#), on page 104.

For more information about creating and editing templates, refer to the user manual of the R&S InstrumentView software package.

Datasets on the other hand are an image of the measurement configuration and result. Typically, you will only create them during or after the measurement and they include information if a template is used in the measurement. They are useful, for example, to recreate the context of the measurement, for documentation purposes or a more detailed analysis with another tool later on. You can also use a dataset to create a [custom preset state](#).

Storage devices

You can store all this data on the internal memory of the R&S FPC or on external storage devices like memory sticks that you can connect to one of the USB ports of the R&S FPC.

The default storage device depends on which devices are connected.

- If a memory stick is connected, datasets are always stored there first.
- The internal memory is used only if no memory stick is connected.

Note that the internal memory of the R&S FPC is limited to several Mbytes. Therefore it is recommended that you use an external memory device like a USB stick to save measurement data or screenshots and only keep templates and datasets that you require regularly on the internal memory.

If you use an external storage device, the available disk space is limited only by the size of the storage device.



Free space of the internal memory

You can find out the disk space that is left on the internal memory of the R&S FPC in the file manager.

Open the file manager ("Save Recall" > "File Manager"). The free disk space is indicated at the top of the dialog box.

Folder structure of the internal memory

The internal memory has a given folder structure. Basically, each data type has its own designated folder.

For example, there is a folder labeled `\Channel Tables` that contains all channel tables that are delivered with the firmware. Another folder is labeled `\Datasets` that is the default folder for saving a dataset.

Of course, you can save a dataset in the `\Limit Lines` folder, but for a good file organization, it is recommended not to mix up file types.

Using in the file manager

The file manager is a tool that provides functionality to manage the files in the internal memory or on external storage devices.

1. Press the "Save Recall" key to open the file menu.
2. Select the "File Manager" menu item to open the file manager.

The R&S FPC shows the contents of the root directory of the internal memory.

Use the rotary knob or the cursor keys to navigate through the folder contents.

Press the "✓" key or the rotary knob twice to access the contents of the folder you have selected.

3. Apply one of the actions to the selected file or folder.
 - "Preview"
See "[Previewing a dataset](#)" on page 50.

- "Load"
See "[Restoring datasets](#)" on page 50.
- "Sort"
Sorts the folder contents by certain criteria: alphabetically ("Sort on Name"), chronologically ("Sort by Date / Time") or by file size ("Sort on Size").
- "Show Compatible"
Filters the folder contents by their compatibility to the current measurement configuration.
- "Show All Files"
Removes the compatibility filter that you have previously applied.
- "Edit"
Allows you to edit the file or folder (item).
 - "Mark": Selects the item. You can recognize a selected item by the check mark in front of the item name.
 - "Rename": Allows you to rename an item.
 - "Cut": Allows you to move an item to another location.
 - "Copy": Copies an item to another location.
 - "Paste": Inserts the cut or copied item into the new location.
 - "Delete": Deletes the selected item.
 - "Refresh": Refreshes the folder contents.



Read-only files

If a file is labeled with a lock symbol in the "Stat" column of the file manager, it is read-only and therefore cannot be edited.

You can remove the read-only attribute in several ways.

- Connect the R&S FPC to a PC and start the R&S InstrumentView software. In the software, start "Instrument" > "File Transfer", select a file and lock or unlock the file with the "Lock" feature.
- Copy the file to a computer and remove the attribute with the Windows functionality (right click on the file, select "Properties" and remove the check from the "Readonly" checkbox).
- Use the `SYSTEM:SET:UNLOCK` command to remove the read-only attribute. Note that you might have to select the correct directory first with `MMEORY:CDIRECTORY`.

Saving datasets

A dataset contains all kinds of information about the current measurement, like the measurement configuration and the measurement results.

1. Press the "Save Recall" key to open the file menu.
2. Select the "Save" menu item to open the file manager.

When you save a dataset, the R&S FPC automatically opens the `\Datasets` folder.

3. If you want to save the dataset in a different folder or an external memory device, navigate to the folder you like.
4. Enter the file name in the "Save As" input field.

The default file name for datasets is `Dataset###.set` with a new number in ascending order for each new dataset. The file extension for datasets is `.set`. If necessary, you can [change the default file name](#) for datasets.

If you enter another name, the R&S FPC uses that name and assigns a new number to the file name if you save the data set the next time. This function allows you to assign consecutive dataset file names without entering a new name every time you want to save a dataset.

You can enter the file name with the alphanumeric keypad. Each key covers more than one character. To get the character you want, press the key in question the appropriate number of times.

5. Confirm saving the dataset with the "Save" menu item.

Defining meta information for datasets

You can include various meta information in datasets that you save. This meta information is then included in measurement reports that you create with the R&S Instrument-View software.

1. Press the "Setup" key to open the setup menu.
2. Select the "User Preferences" menu item.
3. Select one of the items in the "Site" category.
 - "Site Name": Enter the location where the measurement takes place.
 - "User": Enter the name of person who does the measurement.
 - "Comments": Enter any comment about the measurement (note that the length of the comment is limited).

The R&S FPC adds the information you have entered to any dataset you save from now on.

Changing the default directory to store data

The R&S FPC provides several predefined directories in which it stores a specific file type. For example, the R&S FPC automatically stores screenshots in the `\Public\Screen Shots\` directory. If you want to save a dataset, it automatically opens the `\Public\Datasets\` directory, and so on.

If you prefer to store all your data, regardless of file type, in a custom directory, you can change the default directory.

1. Press the "Setup" key to open the setup menu.
2. Select the "User Preferences" menu item.
3. Select the "Working Directory" menu item.

The R&S FPC opens the file manager.

4. Select your preferred directory to store data in.
5. Confirm your selection with "Load".
6. Select the "Using Working Directory" menu item and turn it "On".

Screenshots are automatically stored in the working directory you have selected. When you save a dataset, the R&S FPC automatically opens the file manager at the working directory.

Changing the default file name for datasets

1. Press the "Setup" key to open the setup menu.
2. Select the "User Preference" menu item.
3. Select the "Default Dataset Name" menu item in the "Dataset" category.
4. Enter the default file name you like.

From now on, the R&S FPC will save datasets with the file name you have entered. It will still add a consecutive number to the file name (`Result001`, `Result002` etc.).

Restoring datasets

1. Press the "Save Recall" key to open the file menu.
2. Select the "Recall" menu item to open the file manager.

When you restore a dataset, the R&S FPC automatically opens the `\Datasets` folder.

3. If you want to restore the dataset from a different folder or an external memory device, navigate to the folder with the dataset.
4. Confirm your selection with the "Load" menu item.

Previewing a dataset

Before you restore a dataset, you can preview the dataset. This can be useful, if you are not sure which dataset you want to restore and view all available datasets first.

The preview is like a screenshot and lets you take a quick look at that measurement and its settings. The R&S FPC does not yet activate the measurement settings of that dataset.

1. Press the "Save Recall" key to open the file menu.
2. Select the "Recall" menu item to open the file manager.

When you want to preview a dataset, the R&S FPC automatically opens the `\Datasets` folder.

3. If you want to preview the dataset from a different folder or an external memory device, navigate to the folder with the dataset.
4. Confirm your selection with the "Preview" menu item.

You can preview all available datasets in the selected folder with the "Prev" and "Next" menu items.

When you have found a dataset that you would like to restore, you can restore it directly with the "Recall" menu item.

Taking screenshots

You can take and store a screenshot of the current screen anytime with the camera key.

If available, the R&S FPC stores the screenshot on an external storage device (USB memory stick). If it can find no external memory, the R&S FPC stores the screenshot on the internal memory.

By default, the screenshot is a `.png` file and has the filename `Measurementxxx.png`, with `xxx` being a consecutive number. You can change the file type and default filename.

1. Press the "Setup" key to open the setup menu.
2. Select the "User Preference" to open the user preference menu.
3. Select the "Default Filename" menu item to change the default filename.
Enter any filename you like with the alphanumeric keys, for example "Screenshot". Every screenshot that you take from now on will have that name.
4. Select the "Filename Counter Starts At" menu item to change the numbering of screenshots.
Enter any number you like with the alphanumeric keypad, for example "100". The next screenshot you take will begin with the number 100. All subsequent screenshot will have a number starting from 100.
5. Select the "Capture Screen Format" menu item to select the file type for the screenshot. You can save screenshots as a `.png` or `.jpg`.

Previewing screenshots

You can have a look at screenshots you took on the R&S FPC.

1. Press the "Save Recall" key to open the file menu.
2. Select the "Recall Screenshot" menu item to open the file manager.
3. Navigate to the screenshot you would like to view.
4. Confirm your selection with the "Preview" menu item.

11 Signal Source Configuration

Access: "Meas" > "Source"

Remote commands to configure the signal source:

- [Chapter 19.9, "Signal Source Configuration"](#), on page 226

Available for the R&S FPC1500 and in the spectrum and VNA applications.

The signal source settings control the signal output on the corresponding RF connector on the front panel of the R&S FPC. You can use the signal source for transmission measurements, for example. The frequency and level of the generated signal is variable.

Selecting the output frequency

The output frequency depends on the mode you have selected.

1. Press the "Meas" key.
2. Select the "Source" menu item to open the signal source menu.
3. Select one of the signal source modes.
 - "Off"
Turns off the signal source. No signal is output on the RF connector.
 - "CW"
Opens an input field that allows you to define the output frequency. The output signal is a continuous wave signal whose frequency remains the same throughout the measurement.
 - "CW Coupled"
The output signal is a continuous wave signal whose frequency is coupled to the [center frequency](#). When you change the center frequency, the R&S FPC adjusts the output signal accordingly.
 - "Tracking Generator"
The output signal is a continuous wave signal whose frequency is coupled to the measurement frequency.
For time domain measurements (span = 0), use either mode "CW" or "CW Coupled".
For frequency domain measurements (span > 0), the R&S FPC automatically adjusts the frequency of the generated signal to the current measurement frequency. The number of frequency changes thus depends on the number of measurement points.
You can define an additional frequency offset for the output signal. The R&S FPC opens the "TG Offset" input field when you turn on the tracking generator. An offset of 1 MHz, for example, generates a signal that is 1 MHz above the measurement frequency.
Defining an offset is possible only when the frequency span is smaller than the full span (max. span = full span - TG offset). You have to reduce the full span

by the offset, for example if the full span of your R&S FPC is 1 GHz, and you want an offset of 200 MHz, you have to reduce the span to 800 MHz.

Defining the output level

NOTICE**Risk of damage to the instrument or DUT**

Make sure that the DUT can handle the signal power that you output via the signal source. Power levels that are too high can damage the DUT.

Make also sure that the reflected power does not exceed 20 dBm. Power levels higher than that can damage or destroy the signal source output.

1. Press the "Meas" key.
2. Select the "Source" menu item to open the signal source menu.
3. Select the "Level" menu item.

The R&S FPC opens an input field to define the level of the output signal.

12 Calibration

Access: "Meas" > "Source" > "Normalization"

Remote commands to calibrate measurements:

- not supported

Available for the R&S FPC1500 and in the spectrum and VNA applications.

Before you measure S-parameters, you should calibrate the measurement. Calibration or system error correction is a separate measurement that determines systematic, reproducible errors. Determining these errors allows you to remove those errors from the actual measurement results, which in turn improves the accuracy of the measurement.

The calibration requires a calibration standard (or calibration kit), whose response characteristics (magnitude, phase and frequency) are known. During calibration, the R&S FPC compares the measurement results of the standards with their known, ideal response. The difference is used to calculate the system errors and derive a set of system error correction data.

For successful and valid calibration, you connect the calibration standard at the reference plane. The reference plane is usually the output of the RF measurement cable.

Calibration remains valid after turning off the R&S FPC or changing into another application as calibration data is saved in the internal memory of the R&S FPC. If you save the measurement in a dataset, calibration data is part of that dataset. When you restore the dataset and repeat the same measurement, you do not have to recalibrate the R&S FPC.

Before you calibrate the R&S FPC for the current measurement, you should set the frequency parameters, reference level and attenuation levels. If you change one of these parameters after a successful calibration, it can become invalid.

Calibration states

The R&S FPC can have one of several calibration states as indicated in the trace information of the diagram header. The possible states depend on the calibration type.

- "(dcal)"
The R&S FPC uses default calibration. For details, see "[Performing a default calibration](#)" on page 56.
- "(uncal)"
The measurement is not calibrated. The uncorrected measurement results are displayed.
- "(norm)"
The measurement has been calibrated with the normalization calibration type. Measurement results are corrected accordingly.
- "(cal)"
The measurement has been calibrated with one of the 1-port calibration types. Measurement results are corrected accordingly.
- "(cal int)"

The correction data between the reference points of the calibration is interpolated. Interpolation is used when you change one of the frequency parameters (start, stop or center frequency). In that case, the distribution of the measurement points is different to the distribution during calibration. This could result in an increasing measurement uncertainty.

Calibration types

- **Normalize S21**

Normalization is a simple way to calibrate the measurement using one calibration standard only. The correction data is deducted from this measurement. As only one calibration standard is used, the isolation between the test ports is ignored. A possible cross-talk between the test ports is therefore not eliminated.

Available for the following measurements: transmission S21, spectrum measurements with signal source.

Required calibration standards: through.

- **Full 1-Port**

Test port 1 is calibrated for reflection measurements over the complete frequency range of the R&S FPC. The calibration requires the calibration standards open, short and load to be connected one after another.

Available for the following measurements: reflection S11, 1-port cable loss, DTF.

Required calibration standards: open, short, load.

- **Easy 1-Port**

Test port 1 is calibrated for measurements on that port. The calibration requires no calibration standards as the R&S FPC tests an open only.

- **1-Port Selective Span**

Test port 1 is calibrated for reflection measurements over the currently selected frequency range (span). The calibration requires the calibration standards open, short and load to be connected one after another.

Available for the following measurements: reflection S11, 1-port cable loss, DTF.

Required calibration standards: open, short, load.

Selecting a calibration kit

Every calibration kit has different phase characteristics. Therefore, you have to specify the calibration kit you are using to avoid phase errors during calibration. The R&S FPC then corrects the measurement results accordingly.

You can either use one of the calibration kits designed for use with the R&S FPC, for example the R&S FSH-Z28 and -Z29 calibration kits. Those kits provide an "Open", "Short" and "Load" calibration standard in one piece. The characteristics of these calibration kits are already stored in the R&S FPC firmware.

In addition, you can create and edit calibration kits with the R&S InstrumentView software package and then transfer them to the R&S FPC.

When you use calibration kits, make sure that the electrical length of the calibration kit is similar to that of the R&S FSH-Z28 or -Z29. The electrical length of the "Open" and "Short" of these calibration kits is 5.27 mm. If the electrical length is different, an additional phase error can occur.

1. Press the "Meas" key to enter the measurement menu.

2. Select the "Calibrate" menu item to enter the calibration menu.
3. Select the "Calibration Kits <x>" menu item.
The R&S FPC opens a dialog box that contains a list of all calibration kit specifications stored on the R&S FPC.
4. Select the calibration kit you are using.
After you have selected the calibration kit, you can calibrate the measurement.

Performing a default calibration

You can do a full 1-port calibration and save the correction data as the default calibration. The default calibration is then restored after a preset. A default calibration can be useful, for example, if you repeat the same measurement several times.

A certain default calibration remains in the memory of the R&S FPC until you perform another default calibration.

1. Press the "Setup" key to open the setup menu.
2. Select the "Instrument Setup" menu item to open the instrument setup dialog box.
3. Select the calibration kit you are using for the default calibration ("Calibration Kit" menu item).
4. Start the calibration with the "Perform Default Calibration" button.
The R&S FPC initiates the calibration. Follow the instructions on the display.
After the calibration is done, the R&S FPC shows the last calibration date, the last calibration frequency and the calibration kit you have used in the read-only fields below the "Calibrate" button.
From now on, the R&S FPC restores the default calibration after a preset.
An exception to this rule is if you turn off the "Discard Calibration Data" feature.
5. Press the "Setup" key to open the setup menu.
6. Select the "User Preference" menu item to open the user preference dialog box.
7. Select the "Discard Calibration Data" menu item.
 - "On": Discards the current calibration data. If default calibration data is available, the R&S FPC restores the default calibration.
 - "Off": Keeps the current calibration data. The R&S FPC does not restore default calibration in that case.

Calibrating a measurement

The procedure below shows a normalization calibration routine.

All other calibration methods basically work the same way, except for the type and number of calibration standards you are going to need.

1. Disconnect the DUT from the RF cable.
The RF cable remains connected to the R&S FPC.
2. Press the "Meas" key to enter the measurement menu.

3. Select the "Signal Source" menu item to open the signal source menu.
4. Turn on the "Tracking Generator".
5. Select the "Normalize S21" menu item.

The R&S FPC asks you to set up a "Through" connection from port 1 to port 2.



6. Firmly connect the "Through" connection to port 1 and port 2.
7. Select the "Continue" menu item to start normalization.

After finishing the calibration, the R&S FPC shows that calibration is finished for a short time ("Calibration Done").



The status line now contains the corresponding status label.

Spectrum Analyzer - Spectrum			
REF:	-20 dBm	RBW:	3 MHz
• ATT:	20 dB	PA:	OFF
Source:	TG	LVL:	-30 dBm
• 1 Sa Clrw S21 (norm)			

Activating correction

After you have normalized or calibrated the measurement, you have to activate the correction of the measurement results.

If you do not activate the correction of the results, the R&S FPC displays the uncorrected results.

1. **In the spectrum application:**
Press the "Meas" key to enter the measurement menu.
2. Select the "Signal Source" menu item to open the signal source menu.
3. Select the "Normalization S21" menu item.
The R&S FPC applies the correction values (menu item turns light blue).
4. **In the VNA application:**
Press the "Meas" key to enter the measurement menu.
5. Select the "Calibration" menu item to open the calibration menu.
6. Select the "User Cal" menu item.

The R&S FPC applies the correction values (menu item turns light blue).
If you have a default calibration, default calibration is applied if you do not activate user calibration.

13 Measurement Wizard

The measurement wizard is a tool that allows you to combine several individual measurement configurations to a sequence of measurements (or measurement set). Each individual measurement configuration is based on a [dataset](#) that you have previously saved. Because all relevant parameters have been defined before the actual measurement and cannot be changed once the measurement procedure has begun, the wizard is a good way to avoid mistakes and save time when setting up measurements.

This topic describes the functionality of the measurement wizard. For details on the individual measurements you can perform with the wizard, refer to the corresponding chapters.

- [Chapter 14, "The Spectrum Application"](#), on page 66
- [Chapter 15, "The Receiver Application"](#), on page 134
- [Chapter 16, "Analog Demodulation"](#), on page 147
- [Chapter 17, "Digital Demodulation"](#), on page 158

You can use the wizard for measurements in all available applications.

Note that it is necessary to install and use the R&S InstrumentView software package if you want to access and use the measurement wizard.

Before you can use the measurement wizard, you have to define a measurement set with the R&S InstrumentView software package and transfer it to the R&S FPC.

The R&S InstrumentView software package is available for download on the R&S FPC website at www.rohde-schwarz.com/manual/fpc.

Creating a measurement set

A measurement set consists of several datasets. A dataset is a file that contains the settings of a specific R&S FPC configuration, for example frequency, scaling etc. To get hold of a dataset, set up the R&S FPC as you need and save the configuration or use one of the predefined datasets.

For more information about how to create measurement sets, see ["Saving datasets"](#) on page 48.

1. Start the R&S InstrumentView software on your PC.
2. Open the "Wizard Set" editor in the software ("Preparation" > "Wizard Sets").
The R&S InstrumentView opens a dialog that provides all functionality to manage measurement sets.
3. Create a new measurement set from scratch or open an existing measurement set to edit that set.
Define global characteristics of the measurement set in the "Global" category.

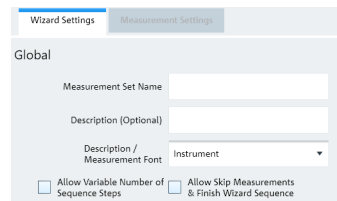

Figure 13-1: Global measurement set settings

4. Define a "Measurement Set Name" and, if you like, a measurement "Description".
5. **Optional:** Select a different "Measurement Font".
The measurement font selects the type of font used to display the instructions on the R&S FPC.
6. **Optional:** Turn on the "Variable Number of Sequence Steps" feature.
When you turn this on, you can reduce the number of individual measurements in a measurement sequence.
7. **Optional:** Turn on the "Allow Skip Measurements & Finish Wizard Sequence" feature.
When you turn this on, you can skip a measurement and continue with the next one.
8. **Optional:** Protect the measurement set from unauthorized access with a password ("Encryption" category).
When you protect the measurement set with a password, you can edit the contents of the measurement set only after you have entered the correct password.
In addition, you can control who is using the measurement sets by limiting its access to a particular set of R&S FPC serial numbers only. All other devices will not be able to process these wizard files.
9. Add one or more datasets to the measurement sets.
You can preview datasets with the "View" button to check the configuration of that dataset. In the preview pane, you can also apply analysis tools to the measured data, like markers and limit lines or change the scale of the y-axis, if necessary.
After you have added at least one dataset (an individual measurement), you can define various properties for that measurement in the "Measurement Settings" tab.

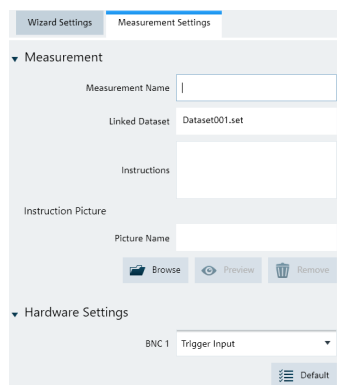

Figure 13-2: Measurement settings for a dataset

Do that for all datasets you have added to the measurement set.

10. Define the "Measurement Name" and instructions for that measurement. You can add instructions as text and as an image.
11. **Optional:** Configure the "Hardware Settings".
12. "Save" the measurement set (the file extension for measurement sets is `.mdf`).

Uploading measurement sets to the R&S FPC

After you have created a measurement set, you have to upload it to the R&S FPC. When you have uploaded the measurement set, you can perform the actual measurement sequence you have defined with the R&S FPC.

1. Open the "File Transfer" dialog box in the R&S InstrumentView software ("Instrument" > "File Transfer").
2. Select the "Wizard Sets" folder on both the R&S FPC (left pane) and the PC (right pane).
3. Select the measurement set you would like to transfer.
4. Transfer the file to the R&S FPC with the "<<" button. Alternatively, you can use a memory stick to access a measurement set on the R&S FPC.

Using the measurement wizard

After you have uploaded a measurement set to the R&S FPC, you can start the measurement sequence.

1. Press the "Save Recall" key.
2. Select the "Wizard" menu item to open the wizard menu.
3. Select the "Load Measurement Set" menu item.
4. Select the folder that contains the measurement set and select it with the "Load" menu item.

The R&S FPC shows the measurement specification. The measurement specification contains a list of the individual measurements (datasets) defined for the measurement set, and their current state ("**<done>**" or "**<not done>**").



Figure 13-3: Measurement specification shows the measurement sequence

You can access the measurement specification with the "Measurement Specification" menu item.

5. **Optional:** Select one of the measurements. You can view and configure various properties of the measurement set with the "Measurement Setting" menu item.

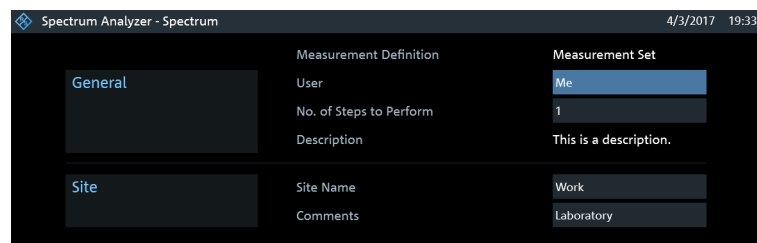

Figure 13-4: Measurement settings show the details of the measurements in the measurement sequence

- "Measurement Definition"
Shows the **name** of the measurement set as defined with the R&S InstrumentView software.
- "User"
Enter the name of the person that performs the measurement.
- "No of Steps to Perform"
Enter the number of measurements you want to perform.
The field allows you to reduce the number of individual measurements and perform only those measurements that are really necessary. If you reduce the number of measurements, the R&S FPC omits the last measurements in the sequence.
You can edit this field only if you have turned on the "Allow Variable Number of Sequence Steps" in the "Wizard Set" editor of the R&S InstrumentView software.
- "Measurement Description"
Shows the short description of the measurement as defined with the R&S InstrumentView software.
- "Site Name"
Enter the location of the measurement.
- "Comments"
Enter any comments about the measurement, for example the external conditions during the measurement.

6. Start the measurement sequence with the "Start Measurement" menu item.

The R&S FPC starts to go through the measurements that are part of the measurement set. The sequence of the measurement is as defined with the R&S InstrumentView software.

Note that it is not possible to change any measurement parameters while using the measurement wizard. Marker functionality and scaling parameters are, however, available.

Before each measurement, the wizard shows a message box that contains the [instructions](#) for that measurement.



Figure 13-5: Prepare the measurement as described when this message shows up

7. Prepare the measurements as instructed. When you are done, you can start the measurement.
8. You have several options before you start a measurement.
 - "Continue"

Finishes the current measurement and begins with the next measurement by showing the necessary preparations.
 - "Repeat Measurement"

Repeats the current measurement. Repeating a measurement can be useful, for example, if the results do not match your expectations and you want to validate the results.
 - "Interrupt"

Interrupts the sequence of measurements. Interrupting a measurement can become necessary if the measurement does not yield the expected results (for example violated limit lines).

In that case, you can interrupt the measurement sequence and try to find the origin of the problem by using different settings or measurements than those defined in the wizard.

When you interrupt the wizard sequence, the complete functionality is available as if you would not use the wizard. Results of finished measurements remain in the memory.

When you are finished reconfiguring the measurement, enter the measurement wizard and resume the measurement sequence with the "Resume Sequence" menu item.
 - "Skip"

Skips a single measurement and initiates the subsequent measurement. Skipping individual measurements is possible when you turn on "Allow to skip measurements and finish wizard sequence" in the "Wizard Set" editor of the R&S InstrumentView software.
 - "Finish Wizard"

Ends the measurement sequence. The results of finished measurements remain in the memory.

Ending a measurement sequence is possible when you turn on "Allow to skip measurements and finish wizard sequence" in the "Wizard Set" editor of the R&S InstrumentView software.

- "Cancel"
Aborts the measurement sequence. The results of finished measurements are lost.

When all measurements of the sequence are done, the R&S FPC shows a corresponding message.



Figure 13-6: On screen information that all measurements are done

When you have finished all measurements that are part of the measurement sequence, the R&S FPC asks you if you want to save the measurement results.

9. Select the "Save Result" menu item to save the results.
If you do not want to keep the results, you can discard the results with the "Discard Result" menu item.

Tip: Limited internal memory. If you have to store the results on the internal memory, make sure that it has enough space left to store them. Else the results might get lost. If the space is not enough, you can delete old data with the file manager. For more information, see ["Using in the file manager"](#) on page 47.

The results for a measurement set consist of several files, each file corresponding to one of the measurements. For easy evaluation, the R&S FPC includes the name of the measurement as defined in the wizard dialog or R&S InstrumentView in the file name.

All result files that belong to a measurement set are stored in the same directory. The directory is named after the measurement name and site. The syntax is 'site-name_measurement_#'

The R&S FPC adds numbers in ascending order to files as well as directories if you perform a measurement or measurement set more than once.

Evaluating results

The R&S InstrumentView software provides functionality to evaluate results and compile measurement reports. However, before you can start to evaluate the results you have to download the results to your computer.

1. Open the "File Transfer" dialog box in the R&S InstrumentView software ("Instrument" > "File Transfer").
2. Select the "Wizard Sets" folder on both the R&S FPC (left pane) and the PC (right pane).
3. Select the measurement set you would like to transfer.
4. Transfer the file to the R&S FPC with the ">>" button.
Alternatively, you can use a memory stick to access a measurement set on the R&S FPC.

Now that the results are available, you can start to compile a measurement report with the R&S InstrumentView software.

5. Start the "Report Generator".

With the report editor, you can create measurement reports for the full measurement set or a selection of dataset only. You can also perform simple tasks like activating or deactivating markers that have been set during the measurement.

6. Add the results you want to include in the report by setting a checkmark or removing the checkmark in the report pane.
7. Select the report format you would like.
8. Create the report with the "Generate" button.

14 The Spectrum Application

The spectrum analyzer application is the base application of the R&S FPC. It provides conventional spectrum analyzer functionality. In addition to basic frequency and time domain measurements, it also features several more sophisticated measurements like the channel power measurement or the OBW measurement (occupied bandwidth).

The spectrum application also provides a wide range of settings and tools to configure and analyze spectrum measurements.

Selecting the spectrum application

1. Press the "Mode" key to open the mode menu.
2. Select the "Spectrum" menu item.

• Configuration Overview	66
• Measurements and Result Displays	68
• Frequency Configuration	93
• Amplitude Configuration	98
• Bandwidth Configuration	106
• Sweep Configuration	109
• Trigger Configuration	112
• Trace Configuration	113
• Marker Configuration	119
• Marker Functions	125
• Display Lines	129
• Limit Lines	130

14.1 Configuration Overview

The configuration overview provides quick access to the most important measurement settings in a single dialog box.

The contents of the configuration overview are arranged in the order of the data flow, and thus the way you usually configure a measurement, from configuring the input over data processing to data analysis. When you use the configuration overview, you can easily configure an entire measurement in a single dialog box without having to access each softkey menu.



Figure 14-1: Configuration overview in the spectrum application

Accessing the configuration overview

1. Press the "Setup" key to open the setup menu.
2. Select the "Config Overview" menu item to open the configuration overview dialog box.
Each pane contains several main measurement settings that you can change directly in the configuration overview.
3. Select one of the panes in the dialog box with the cursor keys or the rotary knob.
4. Confirm your selection with the "✓" key.
The R&S FPC opens a dialog box that contains the settings.
5. Select the setting you want to change with the cursor keys or the rotary knob.
When you confirm your selection with the "✓" key, you can change that setting.
6. You can exit the configuration overview any time with the "Exit" menu item.

The configuration overview contains several panes, each of which contains settings that thematically belong together.

- "Input"
For more information about the contents of the "Input" pane, see [Chapter 14.4, "Amplitude Configuration"](#), on page 98.
- "Amplitude"
For more information about the contents of the "Amplitude" pane, see [Chapter 14.4, "Amplitude Configuration"](#), on page 98.
- "Frequency"
For more information about the contents of the "Frequency" pane, see [Chapter 14.3, "Frequency Configuration"](#), on page 93.
- "Bandwidth"
For more information about the contents of the "Bandwidth" pane, see [Chapter 14.5, "Bandwidth Configuration"](#), on page 106.

- "Analysis"
For more information about the contents of the "Analysis" pane, see [Chapter 14.8, "Trace Configuration"](#), on page 113.
- "Trigger"
For more information about the contents of the "Trigger" pane, see [Chapter 14.7, "Trigger Configuration"](#), on page 112.

14.2 Measurements and Result Displays

The R&S FPC allows you to measure a signal in the frequency domain or the time domain.

You can also equip the R&S FPC with optional extended measurement functions like harmonic distortion or OBW measurements. These measurements provide settings and tools for special measurement tasks.

Measuring basic spectrum characteristics

Basic spectrum measurements require no optional equipment on the R&S FPC.

1. Connect a DUT to the RF input of the R&S FPC.
2. Turn on the R&S FPC.

The R&S FPC measures the characteristics of the DUT in the frequency domain with the default configuration. It shows the results as a line trace in the diagram shown on the display.

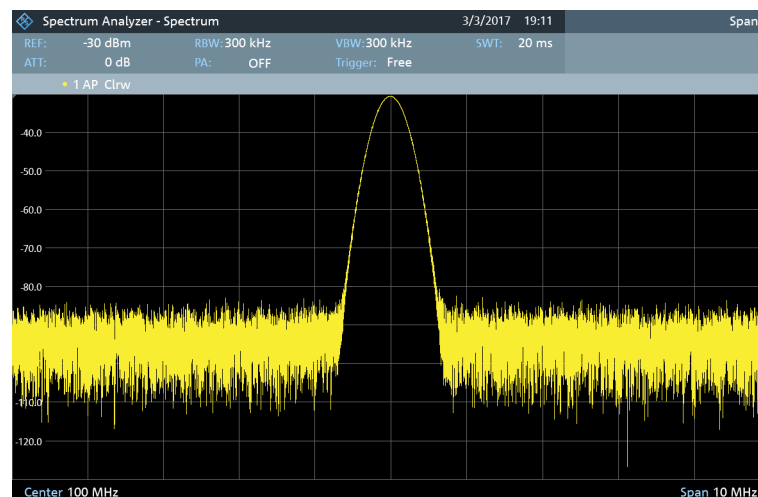

Figure 14-2: Display of a signal in the frequency domain

Alternatively, you can measure the DUT characteristics in the time domain.

Frequency domain measurements

In the frequency domain, the R&S FPC analyzes the input signal characteristics over a certain **frequency span**. You can use it, for example, to obtain basic measurement results like peak levels and the shape of the spectrum.

The horizontal axis shows the frequency, the vertical axis shows the signal levels.

The measurement in the frequency domain is the default measurement mode.

Time domain measurements

In the time domain, the R&S FPC analyzes the characteristics of a signal at a particular frequency over time. The span during time domain measurements is 0 (**zero span mode**). You can use time domain measurements, for example to monitor the characteristics of a signal and its behavior over time.

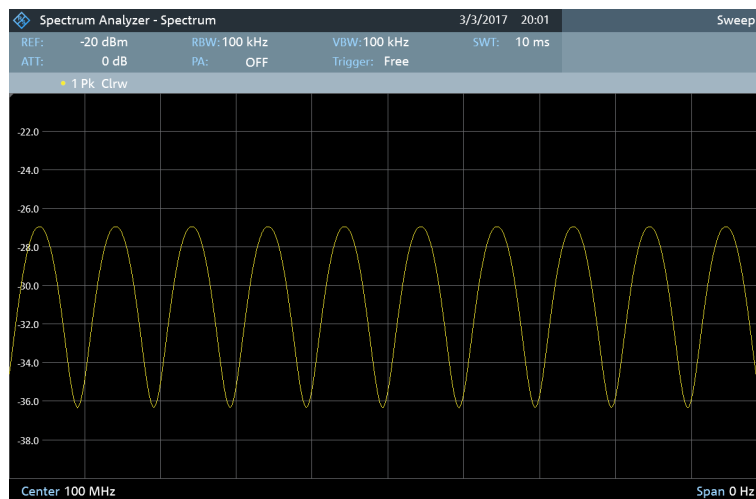

Figure 14-3: Display of a signal in the time domain

The horizontal axis shows the time, the vertical axis shows the signal levels.

You have to select the zero span mode deliberately to measure signal characteristics in the time domain.

Selecting an advanced measurement function

In addition to these basic measurement functions, you can equip the R&S FPC with optional advanced measurements.

1. Press the "Meas" key to open the measurement menu.
2. Select one of the menu items.
Selecting "Spectrum" returns to the basic spectrum analysis.

- [Measuring the Channel Power of Continuously Modulated Signals](#)..... 70
- [Third Order Intermodulation](#)..... 74
- [Power Measurements on TDMA Signals](#)..... 75
- [Measuring the Harmonic Distortion](#)..... 78

- [Measuring the AM Modulation Depth](#).....79
- [Measuring the Occupied Bandwidth](#)..... 81
- [Working with the Spectrogram Result Display](#)..... 84

14.2.1 Measuring the Channel Power of Continuously Modulated Signals

Access (measurement menu): "Meas" > "Measurement Mode" > "Channel Power"

Remote commands to control channel power measurements:

- [Chapter 19.12.1, "Measurements and Result Displays"](#), on page 232

Available with the optional "Advanced Measurements" application.

The channel power measurement selectively measures the power of modulated signals. Unlike a power meter that performs measurements over its entire frequency range, the channel power measurement measures the power of a specific transmission channel. Other signals in the frequency spectrum don't show in the results.

When measuring the spectrum within a channel, the R&S FPC uses a resolution bandwidth that is small compared to the channel bandwidth. It then determines the total power of the channel by integrating the results on the trace.

That means that you can compare the result to the result that would have been obtained from a thermal power meter. The small resolution bandwidth acts like a narrow channel filter and so prevents out-of-channel emissions from affecting the result.

Selecting the channel power measurement

1. Press the "Meas" key to open the measurement menu.
2. Select the "Measurement Mode" menu item to select the measurement.
3. Select the "Channel Power" menu item.

The R&S FPC starts to measure the channel power.

Two vertical lines indicate the channel bandwidth.

The channel power measurement shows the results and various other information about the measurement in the diagram header.

- **Power / Max Power**
Shows the power level measured within the channel. The label changes depending on the [power mode](#) you have selected.
- **Channel BW**
Shows the currently selected channel bandwidth.

The diagram footer shows the currently selected [center frequency](#) and [span](#).

- [About the Measurement](#).....71
- [Configuration](#).....71

14.2.1.1 About the Measurement

The following prerequisites and settings are necessary to obtain correct results for the channel power measurement.

- Define the correct channel bandwidth.
Only the signal to be measured should be visible in the diagram. An additional signal would falsify the measurement.
- Define a sufficient [resolution bandwidth](#).
- Select the [RMS detector](#). This ensures that the power measurement is always correct irrespective of the waveform being investigated.

Define a sufficient [span](#).

The span is always coupled to the channel bandwidth (span = 1.2 to 5 x channel bandwidth, depending on the channel bandwidth). When you change the channel bandwidth, the R&S FPC automatically adjusts the span, but not the other way around.

14.2.1.2 Configuration

Access: "Meas"

The channel bandwidth measurement supports several settings exclusive to that measurement. These are available in the measurement menu.

Defining the channel bandwidth

The channel bandwidth is the bandwidth of the signal that you are measuring.

Note that the channel bandwidth and [frequency span](#) are coupled. When you select a channel bandwidth, the R&S FPC automatically defines an appropriate span for the channel bandwidth you have defined (span = 1.2 x channel bandwidth). This mechanism ensures correct channel power measurements.

1. Press the "Meas" key to open the measurement menu.
2. Select the "Chan Bandwidth" menu item.

The R&S FPC opens an input field to define the channel bandwidth.

3. Enter the channel bandwidth you need.

Note: The minimum channel bandwidth that you can set is 833 Hz at a span of 1 kHz.

Measuring the maximum channel power

If signal levels fluctuate significantly, you can measure the maximum channel power with the max hold function.

1. Press the "Meas" key to open the measurement menu.
2. Select the "Power Display" menu item.
3. Select the "Max Hold" menu item.

The displayed result shows the highest channel power that has been measured (indicated by the "Max Power" result in the diagram header).

4. You can return to the normal power display by selecting the "Clear / Write" menu item instead.

Measuring the channel power density

By default, the R&S FPC the channel power result corresponds to the complete channel bandwidth you have selected. You can also display the channel power that corresponds to a bandwidth of 1 Hz. In that case, the results are no longer displayed in dBm, but in dBm/Hz.

Using this evaluation method, you can measure the signal / noise power density, for example.

1. Press the "Meas" key to open the measurement menu.
2. Select the "Power Display" menu item.
3. Select the "Channel Power / Hz" menu item.

The displayed result shows the channel power measured in a bandwidth of 1 Hz (indicated by the different unit in the channel power result in the diagram header).

4. You can return to the normal power display by selecting the "Channel Power / Hz" menu item again.

Selecting the unit for power display

The R&S FPC can apply different units to the power output.

1. Press the "Meas" key to open the measurement menu.
2. Select the "Power Unit" menu item to open the power unit menu.
3. Select the unit you want.

The R&S FPC displays the signal level in the selected unit.

Note: The default unit is dBm.

Selecting a standard

You can store the main measurement settings as a standard file. When you load such a standard file, the R&S FPC automatically configures the measurement regarding channel and general measurement settings.

Standard files for common telecommunications standards are already provided with the R&S FPC firmware.

If you want to measure a different standard, you can also create custom standard definition files with the R&S InstrumentView software and transfer them to the R&S FPC. For more information, refer to the documentation of the R&S InstrumentView.

1. Press the "Meas" key to open the measurement menu.
2. Select the "Standard" menu item.

The R&S FPC opens a dialog box to select the standard.

3. Select one of the available standards.

The R&S FPC loads the configuration of the selected standard. It automatically sets the span, resolution bandwidth, video bandwidth, sweep time and detector required by the standard.

If the measurement is not according to the selected standard anymore (for example if you change a parameter), the R&S FPC shows a blue dot in front of the standard display.

Defining the reference level

The **reference level** is the power level that the R&S FPC expects at the RF input. When you select the reference level, make sure that you do not overload the R&S FPC by applying a signal whose power exceeds the maximum reference level.

As the power is measured with a small **resolution bandwidth** compared to the signal bandwidth, it is still possible to overload the R&S FPC, even if the trace is within the measurement diagram. To prevent an overload, measure the occupied bandwidth with the largest resolution bandwidth possible using the peak detector. If you set these parameters, it is not possible for the trace to exceed the reference level.

To simplify operation and to prevent incorrect measurements, the R&S FPC has an automatic routine for setting the reference level.

1. Press the "Meas" key to open the measurement menu.
2. Select the "Level Adjust" menu item.

The R&S FPC performs a measurement to determine the optimal reference level. It uses a resolution bandwidth of 1 MHz, a video bandwidth of 1 MHz and the peak detector. After finishing the automatic measurement, the R&S FPC sets the optimal reference level.

Changing the span

Usually, the span that the R&S FPC selects yields optimal results. But sometimes you also need to see the spectrum outside the current span to detect other signal components that you need to include in the measurement. Therefore, you can adjust the span to up to ten times the channel bandwidth and hence still be able to see the spectrum outside the measurement channel.

1. Press the "Span" key to open the span menu.
2. Select the "Manual Span" menu item.

The R&S FPC opens an input field to define the span.

3. Enter the span you need.

Note: The largest possible span for the channel power measurement is ten times the channel bandwidth. At larger spans, the result of the channel power measurement would be increasingly imprecise, because too few points of the trace would be in the channel you are measuring.

14.2.2 Third Order Intermodulation

Access: "Meas" > "Measurement Mode" > "Occupied Bandwidth"

Remote commands to control the third order intermodulation measurement:

- [Chapter 19.12.1.3, "Third Order Intermodulation"](#), on page 238

Available with the optional "Advanced Measurements" application.

Intermodulation is an effect that occurs when you transmit signals on two or more frequencies close to each other. An ideal DUT would output the same signals that you apply to its input. In reality, however, DUTs (like an amplifier or mixer) are nonlinear. This nonlinearity produces additional signals at different frequencies, which can have negative effects on the system, for example interference in a radio transmission.

- Harmonics, which are a multiple of the fundamental frequency ($f \cdot x$).
- Intermodulation products, which are the sum and difference frequencies of the fundamentals ($f_x + f_y$ and $f_y - f_x$).

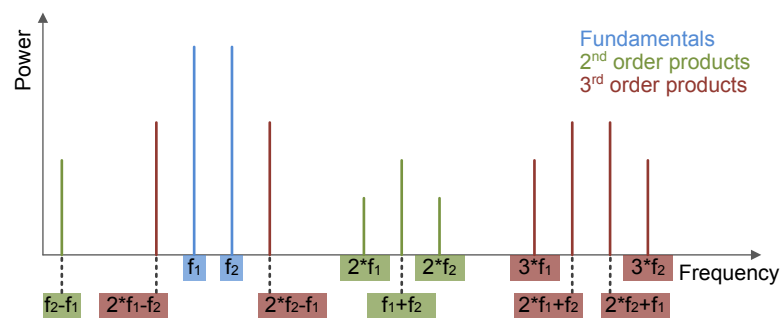
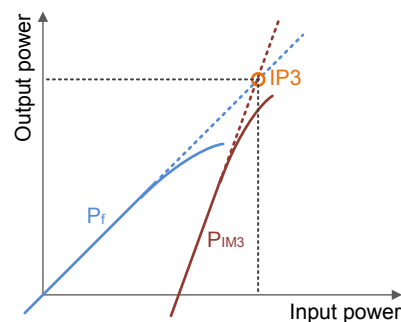

Figure 14-4: Overview of intermodulation products

The third order intermodulation products are of special interest, because:

- Their signal level is comparatively large.
- They occur near the carrier frequency and are thus difficult to filter out.

In addition, the level of the intermodulation products increases when you increase the input level in a ratio of 3:1: Increasing the level of the input signal by 1 dB increases the level of the third order intermodulation product by 3 dB. Eventually, the level of the intermodulation product exceeds the level of the input signal. The point where the two meet is the third order intercept point (IP3).



The third order intermodulation (TOI) measurement analyzes the intermodulation products that occur at the output of the DUT and calculates the third order intercept point. The IP3 is the theoretical intercept point of the DUTs desired output level and the level of the intermodulation products. It is thus a measure of the DUTs linearity.

To perform the TOI measurement, you need two signals with the same level on slightly different frequencies, combine them and feed them into the RF input of the R&S FPC.

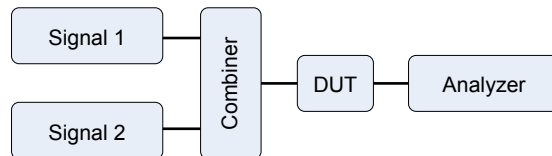

Selecting the TOI measurement

1. Press the "Meas" key to open the measurement menu.
2. Select the "Measurement Mode" menu item to select the measurement.
3. Select the "Third Order Intermod." menu item.

The R&S FPC starts to measure the third order intermodulation.

To do this, the R&S FPC places two markers (marker 1 and marker 2) on the signal peaks (assumed to be the fundamentals) and two markers (marker 3 and marker 4) on the third order intermodulation products. The R&S FPC calculates the third order intercept point from the level difference between the first 2 markers and the markers 3 and 4 and displays the result in the diagram header.

Searching for signals

A signal search is an easy way to update the marker position and thus the measurement results (for example if the signal frequencies have changed).

1. Press the "Meas" key to open the measurement menu.
2. Select the "Search Signals" menu item.

The R&S FPC does a signal search, positions the marker accordingly and updates the TOI results.

14.2.3 Power Measurements on TDMA Signals

Access: "Meas" > "Measurement Mode" > "TDMA Power"

Remote commands required to configure power measurements on TDMA signals:

- [Chapter 19.12.1.5, "TDMA Power"](#), on page 241

Available with the optional "Advanced Measurements" application.

TDMA (time division multiple access) is a channel access method in which several users share a channel. The channel is divided into several time slots (a period of time). Each user is assigned to a certain time slot. GSM is a transmission standard that uses TDMA, for example.

The TDMA power measurement is a time domain measurement that determines the power of one of the time slots or the power of a burst.

Selecting the TDMA power measurement

1. Press the "Meas" key to open the measurement menu.
2. Select the "Measurement Mode" menu item to select the measurement.
3. Select the "TDMA Power" menu item.

The R&S FPC starts to measure the time domain power.

When you start a TDMA measurement, the R&S FPC automatically reduces the span to 0 Hz.

To prevent incorrect power measurements in the time domain, make sure that the whole signal is within the selected resolution bandwidth. If the resolution bandwidth is too small, the displayed power will be lower than the actual power.

The TDMA power measurement shows the results and various other information about the measurement in the diagram header.

- **Power**
Shows the power of the measured burst in dBm.
- **Burst Length**
Shows the length of the measured burst in seconds.

Selecting a standard

A quick way to configure a measurement is to store a certain measurement configuration in a file and later restore it. This way is especially useful, for example, if you test a signal against the test scenarios of a telecommunications standard.

Configurations for common telecommunications standards are already provided with the R&S FPC firmware.

If you want to measure a different standard, you can also create custom configuration files with the R&S InstrumentView software and transfer them to the R&S FPC. For more information, refer to the documentation of the R&S InstrumentView.

1. Press the "Meas" key to open the measurement menu.
2. Select the "Standard" menu item.
3. Select one of the available standards from the dialog box.

The R&S FPC loads the configuration of the selected standard.

Depending on the selected file, the R&S FPC automatically selects the span, resolution bandwidth, video bandwidth, sweep time and detector required by the standard.

If you change the configuration, and one of the parameters differs from the configuration in the active file, the R&S FPC shows a blue dot in front of the standard display.

Defining the reference level

The **reference level** is the power level that the R&S FPC expects at the RF input. When you select the reference level, make sure that you do not overload the R&S FPC by applying a signal whose power exceeds the maximum reference level.

As the power is measured with a small **resolution bandwidth** compared to the signal bandwidth, it is still possible to overload the R&S FPC, even if the trace is within the measurement diagram. To prevent an overload, measure the occupied bandwidth with the largest resolution bandwidth possible using the peak detector. If you set these parameters, it is not possible for the trace to exceed the reference level.

To simplify operation and to prevent incorrect measurements, the R&S FPC has an automatic routine for setting the reference level.

1. Press the "Meas" key to open the measurement menu.
2. Select the "Level Adjust" menu item.

The R&S FPC performs a measurement to determine the optimal reference level. It uses a resolution bandwidth of 1 MHz, a video bandwidth of 1 MHz and the peak detector. After finishing the automatic measurement, the R&S FPC sets the optimal reference level.

Defining the burst length

The burst length or measurement time defines the expected length of the burst. The measurement time is the time period over which the signal power is measured.

The minimum burst time is the time corresponding to one trace pixel. The maximum burst time corresponds to the current sweep time (with the sweep time being the complete time displayed on the x-axis).

The burst time must be equal or less than the sweep time. If you define a burst time that is longer than the sweep time, the R&S FPC selects a burst equal to the current sweep time. To measure a longer burst, you have to increase the sweep time first.

1. Press the "Meas" key to open the measurement menu.
2. Select the "Burst Length" menu item.

The R&S FPC opens an input field to define the burst length.

3. Enter the expected length of the burst.

The R&S FPC analyzes the power of the burst. The current burst length is indicated by two blue vertical lines in the diagram (the first line indicating the beginning of the burst is usually at the origin of the x-axis).

Using a trigger

Using a **trigger** is the best method to measure bursts, as it keeps the display of the burst stable. You can use either the video trigger or an external trigger (if the DUT has some sort of trigger equipment). The functionality of both trigger sources is similar to the functionality in the spectrum application.

1. Connect the DUT trigger output to the R&S FPC trigger input.

2. Press the "Sweep" key to open the sweep menu.
3. Select the "Trigger" menu item to open the trigger menu.
4. Select the trigger source ("Video" or "External Rise / Fall")
5. Select either the "External Rise" or "External Fall" menu item (rising or falling edge).

The R&S FPC activates the trigger and shows the results of the measurement.

14.2.4 Measuring the Harmonic Distortion

Access: "Meas" > "Measurement Mode" > "Harmonic distortion"

Remote commands required to configure harmonic distortion measurements:

- [Chapter 19.12.1.6, "Harmonic Distortion"](#), on page 241

Available with the optional "Advanced Measurements" application.

The harmonic distortion measurement is an easy way to identify the harmonics of a signal and their characteristics.

Ideally, a signal would show as a single peak in the spectrum. In the real world, however, systems contain imperfections, like nonlinearities, which add spectral components to the initial signal (the fundamental, corresponding to the center frequency of the analyzer). Among these additional spectral components are harmonics (also called overtones), signals with higher frequencies than the fundamental, which show as whole number multiples of the fundamental in the spectrum. Each harmonic has a lower level than the fundamental, but they still affect the signal as a whole.

The harmonic distortion is designed to detect the harmonics of the signal you are measuring. When you start a measurement, the R&S FPC looks for the first harmonic of the signal (= the highest signal) in the frequency range you have defined. The number of harmonics it looks for depends on the number of harmonics you have defined. It then adjusts the frequency axis so that all harmonics are visible.

In addition, the R&S FPC also calculates the total harmonic distortion (THD). The THD is the root mean square of all harmonics in relation to the power of the fundamental frequency.

Selecting the harmonic distortion measurement

1. Press the "Meas" key to open the measurement menu.
2. Select the "Measurement Mode" menu item to select the measurement.
3. Select the "Harmonic Distortion" menu item.

The R&S FPC starts to measure the harmonic distortion and position a marker on each harmonic it has detected.

It also calculates the THD and shows the result in the diagram header.

Defining the number of harmonics

The R&S FPC supports measurements on up to six harmonics.

By default, the R&S FPC shows the signal's fundamental and its first harmonic. The fundamental and its harmonics are indicated by a marker that the R&S FPC places on the detected peaks. Note that all markers that have been set are normal markers that show the absolute frequency of the harmonic.

At the same time, the R&S FPC also calculates the values for the total harmonic distortion (THD) and shows the results in a box above the trace diagram. The values are output in % and in dB.

1. If you want to analyze more than one harmonic, press the "Meas" key to open the measurement menu.
2. Select the "Harmonics" menu item.
3. Enter the number of harmonics you would like to see.
The R&S FPC updates the measurement accordingly.

Optimizing measurement settings

1. Press the "Meas" key to open the measurement menu.
2. Select the "Adjust Settings" menu item.
The R&S FPC adjusts the reference level, frequency and span to display all harmonics in the best way.

14.2.5 Measuring the AM Modulation Depth

Access: "Meas" > "Measurement Mode" > "AM Modulation Depth"

Remote commands required to configure AM modulation depth measurements:

- [Chapter 19.12.1.7, "AM Modulation Depth"](#), on page 244

Amplitude modulation (AM) is a modulation scheme that varies the amplitude of the carrier based on the waveform of the transmitted signal.

The AM modulation depth measurement analyzes amplitude modulated signals and shows the spectral signal characteristics. It also analyzes the modulation depth of the signal using the measurement results. The AM modulation depth indicates how much the modulated signal varies around the carrier amplitude. The AM modulation depth m is calculated as follows.

$m = \text{peak signal amplitude} / \text{unmodulated carrier amplitude}$

For example, for $m = 0.5$, the carrier amplitude varies by 50 % above and below its unmodulated level.

For $m = 1$, it varies by 100 %.

Note that the measurement works properly only if you apply an AM modulated signal.

Selecting the AM modulation depth measurement

1. Press the "Meas" key to open the measurement menu.
2. Select the "Measurement Mode" menu item to select the measurement.
3. Select the "AM Modulation Depth" menu item.

The R&S FPC measures the modulation depth by placing three markers on the trace.

The first marker is placed on the peak level - the R&S FPC assumes that the highest level is the carrier. The second and third markers are delta markers. These markers are placed symmetrically on the adjacent peak values to the left and right of the carrier.

From the values of the markers, the R&S FPC then calculates the AM modulation depth. The AM modulation depth is the ratio between the power values at the reference marker and at the delta markers. When the powers of the two AM side bands are not the same, the R&S FPC uses the mean value of the two sideband values. If the R&S FPC is unable to find any AM modulated carriers, it shows a message that the measurement is not possible.

Moving the markers

You can move the markers manually and individually to other positions, if necessary.

1. Press the "Meas" key to open the measurement menu.
2. Select one of the "Marker <x>" menu items to select the corresponding marker.
3. Move the marker to a new position.

Defining a threshold

1. Press the "Meas" key to open the measurement menu.
2. Select the "Threshold" menu item.

The R&S FPC opens an input field to define a threshold.

3. Enter the threshold value you need.

The threshold is represented as a horizontal blue line in the diagram area. Signals below that threshold are not interpreted as sideband signals.

Optimizing the measurement settings

In order to get the best results, you can use the automatic adjustment routine that the R&S FPC offers.

1. Press the "Meas" key to open the measurement menu.
2. Select the "Adjust Settings" menu item.

The R&S FPC performs a measurement to determine the ideal reference level, frequency and span to display all harmonics.

14.2.6 Measuring the Occupied Bandwidth

Access: "Meas" > "Measurement Mode" > "Occupied Bandwidth"

Remote commands to control the occupied bandwidth measurement:

- [Chapter 19.12.1, "Measurements and Result Displays"](#), on page 232

Available with the optional "Advanced Measurements" application.

An important characteristic of a modulated signal is its occupied bandwidth (OBW). In a radio communications system, for example, the occupied bandwidth must be limited to enable distortion-free transmission in adjacent channels. The occupied bandwidth is defined as the bandwidth containing a defined percentage of the total transmitted power.

You can define a percentage between 10 % and 99 %. Numerous standards require an occupied bandwidth of 99 %.

After entering the channel bandwidth, the R&S FPC automatically selects the measurement parameters so that you can attain the best result.

Selecting the OBW measurement

1. Press the "Meas" key to open the measurement menu.
2. Select the "Measurement Mode" menu item to select the measurement.
3. Select the "Occupied Bandwidth" menu item.

The R&S FPC starts to measure the occupied bandwidth.

Two vertical lines show the occupied bandwidth.

The occupied bandwidth measurement shows the results and various other information about the measurement in the diagram header.

- **Occupied bandwidth**
Shows the occupied bandwidth in Hz.
- **Standard**
Shows the selected [standard](#) when you have selected one.
- **% power BW**
Shows the [power percentage](#) of the occupied bandwidth.
- **Channel BW**
Shows the [channel bandwidth](#).

The diagram footer shows the currently selected [center frequency](#) and [span](#).

- [About the Measurement](#).....81
- [Configuration](#).....82

14.2.6.1 About the Measurement

The following prerequisites and settings are necessary to obtain correct results for the occupied bandwidth.

- Define the correct channel bandwidth.

Only the signal to be measured should be visible in the diagram. An additional signal would falsify the measurement.

- Define a sufficient [resolution bandwidth](#).
The resolution bandwidth should be between 1 % and 4 % of the channel bandwidth. This ensures that the occupied bandwidth is measured with high accuracy.
- Define a sufficient [video bandwidth](#).
The video bandwidth must be at least three times the resolution bandwidth. This prevents incorrect results due to the compression of signal peaks by the video filter.
- Select the [RMS detector](#). This ensures that the power measurement is always correct irrespective of the waveform being investigated.
Some of the measurement specifications (for example PDC, RCR STD-27B) require measurement of the occupied bandwidth with a peak detector. The detector setting has to be changed accordingly in those cases.
- Select a sufficient [sweep time](#).

14.2.6.2 Configuration

Access: "Meas"

The occupied bandwidth measurement supports several settings exclusive to that measurement. These are available in the measurement menu.

Defining the percentage of the occupied bandwidth

The default power percentage to be evaluated inside the occupied bandwidth is 99 %, a value most standards require. If your measurement requires a different power percentage, you can change that value.

1. Press the "Meas" key to open the measurement menu.
2. Select the "% Power Bandwidth" menu item.

The R&S FPC opens an input field to define the power percentage.

3. Enter the power percentage the measurement requires.

The R&S FPC now displays the occupied bandwidth graphically in the trace window and numerically above the trace window.

Note: The value you enter here is the power percentage that has to be inside the channel bandwidth relative to the power over the total span (the percentage of the total power).

Defining the channel bandwidth

The channel bandwidth is the bandwidth of the signal that you are measuring.

Note that the R&S FPC always selects a [frequency span](#) that equals the channel bandwidth

1. Press the "Meas" key to open the measurement menu.
2. Select the "Chan Bandwidth" menu item.

The R&S FPC opens an input field to define the channel bandwidth.

3. Enter the channel bandwidth you need.

Note: The minimum channel bandwidth that you can set is 2 kHz at a span of 1 kHz.

Selecting a standard

You can store the main measurement settings as a standard file. When you load such a standard file, the R&S FPC automatically configures the measurement regarding channel and general measurement settings.

Standard files for common telecommunications standards are already provided with the R&S FPC firmware.

If you want to measure a different standard, you can also create custom standard definition files with the R&S InstrumentView software and transfer them to the R&S FPC. For more information, refer to the documentation of the R&S InstrumentView.

1. Press the "Meas" key to open the measurement menu.
2. Select the "Standard" menu item.

The R&S FPC opens a dialog box to select the standard.

3. Select one of the available standards.

The R&S FPC loads the configuration of the selected standard. It automatically sets the span, resolution bandwidth, video bandwidth, sweep time and detector required by the standard.

If the measurement is not according to the selected standard anymore (for example if you change a parameter), the R&S FPC shows a blue dot in front of the standard display.

Defining the reference level

The [reference level](#) is the power level that the R&S FPC expects at the RF input. When you select the reference level, make sure that you do not overload the R&S FPC by applying a signal whose power exceeds the maximum reference level.

As the power is measured with a small [resolution bandwidth](#) compared to the signal bandwidth, it is still possible to overload the R&S FPC, even if the trace is within the measurement diagram. To prevent an overload, measure the occupied bandwidth with the largest resolution bandwidth possible using the peak detector. If you set these parameters, it is not possible for the trace to exceed the reference level.

To simplify operation and to prevent incorrect measurements, the R&S FPC has an automatic routine for setting the reference level.

1. Press the "Meas" key to open the measurement menu.
2. Select the "Level Adjust" menu item.

The R&S FPC performs a measurement to determine the optimal reference level.

It uses a resolution bandwidth of 1 MHz, a video bandwidth of 1 MHz and the peak detector. After finishing the automatic measurement, the R&S FPC sets the optimal reference level.

Changing the span

Usually, the span that the R&S FPC selects yields optimal results. But sometimes you also need to see the spectrum outside the current span to detect other signal components that you need to include in the measurement. Therefore, you can adjust the span to up to ten times the channel bandwidth and hence still be able to see the spectrum outside the measurement channel.

1. Press the "Span" key to open the span menu.
2. Select the "Manual Span" menu item.

The R&S FPC opens an input field to define the span.

3. Enter the span you need.

Note: The largest possible span for the channel power measurement is ten times the channel bandwidth. At larger spans, the result of the channel power measurement would be increasingly imprecise, because too few points of the trace would be in the channel you are measuring.

14.2.7 Working with the Spectrogram Result Display

Access (measurement menu): "Meas" > "Measurement Mode" > "Spectrogram"

Access (measurement menu): "Meas" > "Measurement Mode" > "Spectrogram Playback"

Remote commands to control the spectrogram:

- not supported

Available with the optional "Advanced Measurements" application.

The spectrogram result display shows the spectral density of a signal in the frequency domain and over time simultaneously.

Like other result displays, the x-axis represents the [frequency span](#). The y-axis represents time. Time in the spectrogram runs chronologically from top to bottom. Therefore, the top of the diagram is the present. A third dimension shows the amplitude for each frequency by mapping different colors to every power level.

The color the R&S FPC assigns to a power level that was measured depends on:

- The color table you have selected.
- The spectrogram reference level.
- The spectrogram level range.

The spectrogram consists of horizontal lines, each one pixel high, that are called frames. In the default state, a frame is added to the spectrogram after each [sweep](#). This means that the amount of data in a frame depends on the sweep time. Because the spectrogram in the R&S FPC runs from top to bottom, the outdated time line(s)

move down one position, so that the present frame is always on top of the diagram. Therefore, the sequence of frames is chronological.

Selecting the spectrogram result display

1. Press the "Meas" key to open the measurement menu.
2. Select the "Measurement Mode" menu item to open the measurement mode menu.
3. Select the "Spectrogram" menu item.

The R&S FPC starts the recording of the spectrogram.



By default, the spectrogram result display is made up out of two windows. The upper window shows the [measured spectrum](#) as a line trace. The lower window shows the measurement results in a spectrogram. The amount of information in the spectrogram is restricted by the internal memory of the R&S FPC. The R&S FPC can store up to 1024 frames (= line traces). When the measurement runs longer, the oldest frames are deleted. As the height of the display is smaller than 1024 pixels, some of the data becomes invisible after a time (but remains in the memory).

- [Spectrogram Recording](#)..... 85
- [Color Definition](#)..... 87
- [Spectrogram Playback](#)..... 90

14.2.7.1 Spectrogram Recording

When you are in continuous sweep mode, the R&S FPC starts to record spectrogram data when you enter the spectrogram mode. You can see that the spectrogram result display fills up, as each sweep adds an additional line to the spectrogram.

When you are in single sweep mode, the R&S FPC does not add a line to the spectrogram until you initiate the next single sweep.

Controlling the spectrogram update

In continuous sweep mode, you can interrupt the spectrogram recording.

1. Press the "Meas" key to open the measurement menu.
2. Select the "Hold" menu item.

The spectrogram recording stops. No more new lines are added to the spectrogram.

The measurement itself, however, does not stop. The line trace in the spectrum display is still updated continuously. If you want to stop the measurement completely, you have to stop it by selecting [single sweep mode](#). In that case, the R&S FPC finishes the current sweep and stops the measurement. It keeps the spectrogram data that has already been recorded.

3. Select the "Hold" menu item again.

The R&S FPC resumes updating the spectrogram.

The spectrogram result display is filled with new lines until you change a measurement setting.

When you change a setting (for example the center frequency), the spectrogram clears and starts to fill again.

4. You can also clear the spectrogram manually. Press the "Meas" key.
5. Select the "Clear" menu item.

Resetting the spectrogram

The R&S FPC clears the spectrogram result display when you change a measurement setting, for example one of the frequency settings or the resolution bandwidth.

You can also clear it deliberately.

1. Press the "Meas" key to open the measurement menu.
2. Select the "Clear" menu item.

The R&S FPC deletes the current spectrogram data and starts a new recording.

Displaying the spectrogram in full screen

By default, the spectrogram takes half of the diagram area, with the upper part showing the results of the current sweep as a line trace. You can view more of the signal history by displaying the spectrogram in full screen mode.

1. Press the "Meas" key to open the measurement menu.
2. Select the "Full Screen" menu item.

The R&S FPC now uses the full diagram area of the screen for the spectrogram. The number of lines in the spectrogram and therefore the displayed time period more than doubles.

Note: It can, however, be necessary that the spectrum result display is still visible to evaluate measurement results. For this purpose, the spectrogram has an (invisible) scrollbar that you can use to scroll up and down the spectrogram to the frame that you would like to see.

Scrolling through the spectrogram

As more and more lines are added to the spectrogram, older data is moved down until it disappears from the visible spectrogram. The data itself is still available, but you have to scroll through the spectrogram to see those parts of the spectrogram.

Arrows on the right side of the spectrogram indicate that more data than is visible on the screen is available.

- ▶ Press the "Up" or "Down" cursor keys.

The R&S FPC scrolls through the spectrogram history.

The symbols on the right side of the spectrogram indicate the position of the spectrogram part currently displayed on the screen.

- A single down arrow in the right lower corner of the spectrogram indicates that the uppermost frame still represents the most recently recorded trace.

- Two arrows (one up, one down) indicate that the spectrogram area displayed is somewhere in the middle of the available history.
- A single up arrow in the upper right corner of the spectrogram indicates that the lowest line of the spectrogram represents the end of the history buffer.

14.2.7.2 Color Definition

Colors are an important element of the spectrogram. The R&S FPC provides various features to customize the display for the best viewing results.

Selecting a color scheme

The first and most obvious way to adjust colors is to select a different color scheme.

1. Press the "Meas" key to open the measurement menu.
2. Select the "Settings" menu item to open the spectrogram settings menu.
3. Select the "Color Table" menu item to open the color table menu.
4. Select the color scheme you are most comfortable with.
The R&S FPC adjusts the screen colors according to your selection.

The following color schemes are available.

- Default
- Green-Yellow
- Green-Blue
- Black-White
- Red-Purple
- Blue-Black

Adjusting the color distribution

It is possible that the color distribution is not ideal in the default configuration. The R&S FPC provides several settings to further enhance the color display in the spectrogram.

The following examples are based on the red-purple color scheme.

The first method is to cut the reference level. It eliminates amplitudes from the color map that are not part of the signal.

Example: By default, the spectrogram reference level is -20 dBm.

That means that signal parts with an amplitude of -20 dBm would be red in the spectrogram, and signal parts with a very small amplitude would be purple. Everything in between is a shade of the colors between. As the colors are distributed over a very large range (about a 100 dBm or more), it is likely that you cannot distinguish details in the signal.

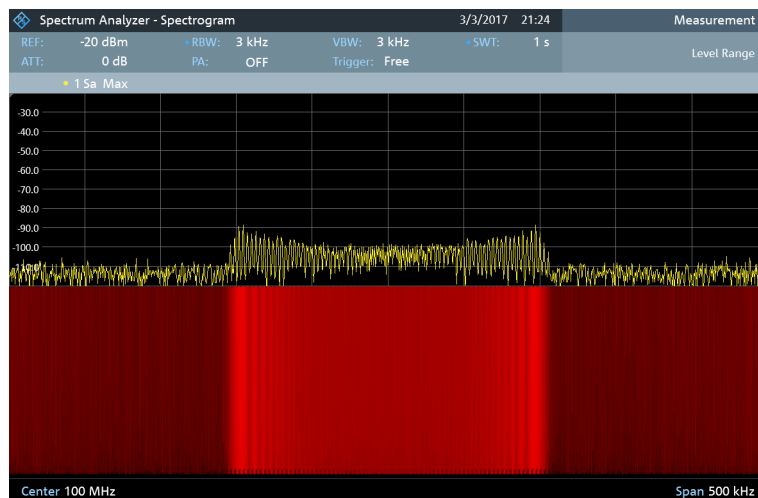

Therefore you can adjust the color map to the overall shape of the signal you are measuring. Let us say, for example, that the signal has an amplitude range of about 30 dB with the maximum amplitude at about -80 dBm and the minimum amplitude at about -120 dBm. With the default settings, the spectrogram is made up exclusively of red colors and it is not easy to distinguish amplitude levels. That is because the purple color shades are completely out of range.

To get a better result, change the spectrogram reference level to a level near the maximum power level that has been measured first.

1. Press the "Meas" key to open the measurement menu.
2. Select the "Level Range" menu item to open the level range menu.
3. Select the "Reference Level" menu item.

The R&S FPC opens an input field to enter the spectrogram reference level.

The reference level should be near the maximum level that has been measured while the spectrogram was running. In the example, the reference level should be at about -80 dBm.

4. Enter the reference level you need.

The R&S FPC now shifts the reference level of the spectrogram to the value you have entered.

Note that the spectrogram reference level does not affect the [reference level](#) of the spectrum analyzer itself. In the same way, the reference level of the spectrum analyzer does not affect the spectrogram. The spectrum trace therefore remains exactly the same.

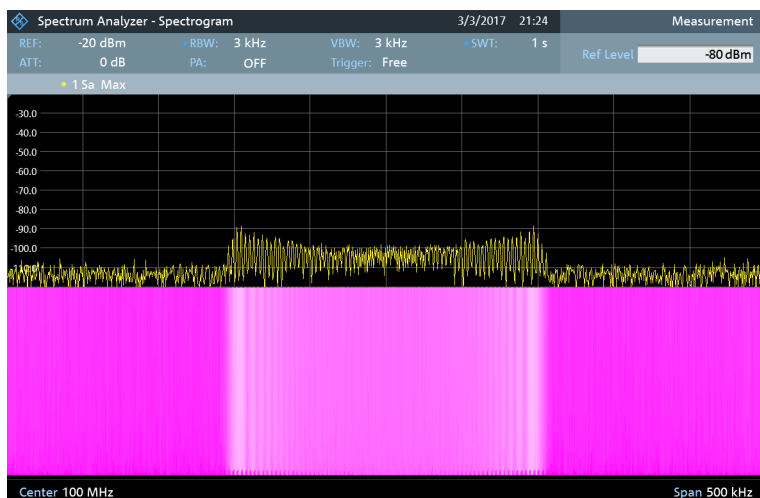

The changes however, still do not show signal differences in detail. The only thing that happened is that the colors have shifted, in the example to purple, because the color that corresponds to the reference level has shifted from red to purple. All other colors that are part of the color scheme are still unused, because the spectrogram level range is still the same (100 dB).

5. Select the "Level Range" menu item.

The R&S FPC opens an input field to enter the spectrogram level range. In the example, the level range of the signal is from about -80 dBm to about -120 dBm.

6. Therefore, set the level range to 40 dB to cover the complete level range of the signal.

As the level range is now adjusted, the R&S FPC is able to map its complete color range to the level range of the signal. This means that signal parts with a low amplitude are in a shade of red while signal parts with a high amplitude are purple.

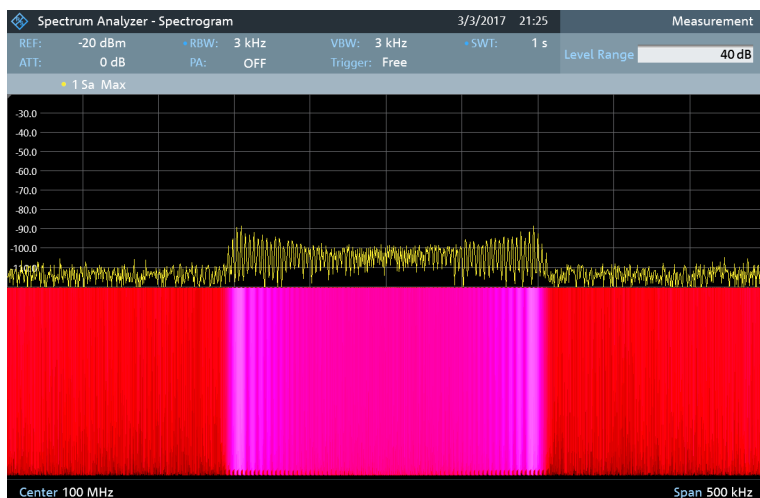

The best way to display a spectrogram is therefore to reduce the level range until the lowest signal part is mapped to the lower end of the color map and the highest signal part to the upper end of the color map.

Note: You can also use the "Auto Range" menu item to adjust the displayed level range. In that case, the R&S FPC selects a level range that best suits the currently measured signal.

In a last step, you can configure the spectrogram in a way that it only shows signal peaks in color and the noise floor in black. To get a result like that you have to reduce the level range, until the noise floor is outside the displayed range.

7. Instead of entering a level range of 40 dB, enter a level range of 30 dB or even 25 dB.

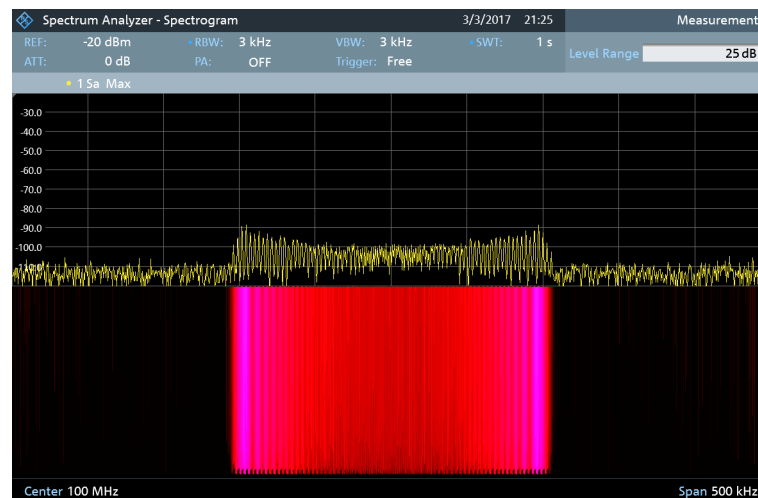

This provides a high contrast between signal parts that are above the noise floor, and the noise floor, which is drawn in black.

To show details of the noise floor, and exclude the peak levels you have to lower the spectrogram reference level, until it is just above the noise floor.

The R&S FPC then displays the signal parts that are above the reference level in only one color, which is the color at the upper border of the color map.

14.2.7.3 Spectrogram Playback

Saving spectrogram data

You can save the data of the spectrogram for documentation or for further analysis of the recorded data.

1. Press the "Meas" key to open the measurement menu.
2. Select the "Save" menu item to open the file manager.
3. Enter the name of the spectrogram with the alphanumeric keys.

By default, the R&S FPC saves the spectrogram as `Spectrogram###` with ascending numbers. The file extension for spectrogram data is `*.spm`.

4. Select the "Save" softkey to store the spectrogram.

Now that you have saved the spectrogram, you can replay it any time you want.

The number of spectrograms that you can store on the R&S FPC internal memory depends on the other datasets that are currently on the R&S FPC.

Playback of a spectrogram

If you have recorded a spectrogram and have saved it in internal memory or a memory stick, you can view the results of that measurement later.

1. Press the "Meas" key to open the measurement menu.
2. Select the "Measurement Mode" menu item.
3. Select the "Spectrogram Playback" menu item.

The R&S FPC enters the spectrogram playback mode. In playback mode, it no longer records any data. Only the data that has been recorded already is displayed.

Restoring a spectrogram

You can restore a spectrogram that you recorded some other time and saved in the internal memory of the R&S FPC or on a memory stick.

1. Press the "Meas" key to open the measurement menu.
2. Select the "Recall" menu item.

The R&S FPC opens the file manager.

3. Select the file you need. The file extension for spectrogram data is *.spm.

The R&S FPC loads the spectrogram and shows the data in the display.

Basically, you can do the same things in spectrogram playback mode as in the spectrogram recording mode, for example customize the display to your needs.

In addition to that functionality, it is possible to view not only the spectrum that belongs to the currently selected spectrogram frame, but also the spectrums of all frames that have been recorded.

Working with time lines in playback mode

To find a particular point in time and display the corresponding spectrum, you can use two time lines.

When you enter the playback mode, the R&S FPC displays two time lines in the spectrogram.

Both time lines (T1 and T2) correspond to an absolute time value, whose position refers to the most recent time frame (top of the diagram). Both time lines are positioned on the most recent spectrogram line at the top of the result display.

You can now select a specific spectrogram frame that is in the memory of the R&S FPC.

1. Press the "Meas" key to open the measurement menu.

2. Select the "Time Line <x>" menu item.

The R&S FPC opens an input field to define the position of the corresponding time line (T1 or T2).

3. Position the time line by entering a number or moving it with the rotary knob.

Entering 0 sets the time line marker on the most recent frame. The maximum value that you can enter is 1024 (the maximum number of frames the R&S FPC can store in its memory).

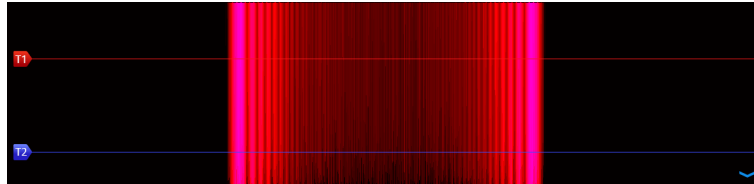

Figure 14-5: Time lines in the spectrogram

Note that not all frames are visible on the screen. If a frame is part of the history outside the visible area, the time line is also not visible and you have to scroll through the spectrogram to be able to see it again.

The upper window displays the spectrum of the frame at the time line position. By moving the time line, you can thus browse through the history of spectra stored in memory.

In the marker information field, the R&S FPC shows the time stamp of the time line. The time stamp of the first time line T1 is always referred to the top-most frame. A time stamp of 00:00:50:000, for example, means that the data was measured 50 seconds prior to the topmost frame).

In addition to the time line (horizontal marker), you can also use (vertical) markers in the spectrogram.

With the help of the [marker](#) and the time line, you are able to find the exact moment when a specific event has occurred in the spectrum.

4. Press the "Marker" key.

The R&S FPC activates a marker and sets it on the peak level of the currently displayed spectrum.

5. Use the rotary knob or the cursor keys to move the marker on the x-axis to the frequency you want to analyze, or enter the frequency directly with the number keys.
6. Select the "Time Line" softkey and browse through the spectrums using the rotary knob or the cursor keys until the spectrum of interest is displayed in the upper window.

The time stamp of the selected time line (displayed in a field above the diagram area) gives you a precise indication on when the event shown in the spectrum occurred.

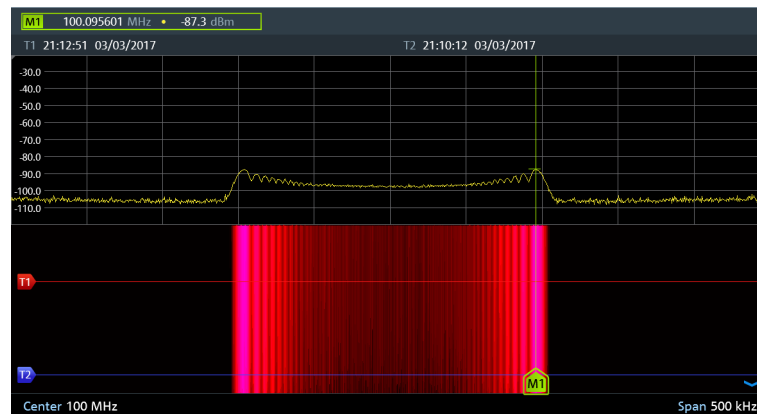

Figure 14-6: Time lines and markers in the spectrogram

Switching back to active spectrogram recording

You can presume the spectrogram recording from playback mode.

1. Press the "Meas" key to open the measurement menu.
2. Select the "Live Update" menu item.

The R&S FPC switches back to a live measurements.

14.3 Frequency Configuration

Access (frequency menu): "Freq"

Access (span menu): "Span"

Access: "Setup" > "Config Overview" > "Frequency" (selected settings)

Remote commands to configure the frequency:

- [Chapter 19.12.2, "Frequency"](#), on page 245

The main application of a spectrum analyzer is to measure the frequency and the power level of a signal and show these signal characteristics in a diagram. The x-axis of the diagram usually contains the frequency information of the signal, while the y-axis usually contains the level information.

Regarding the frequency information, a typical measurement task does not require you to measure the characteristics of the complete frequency range supported by the R&S FPC. Instead, it is usually sufficient to measure the characteristics of a limited frequency range only.

The R&S FPC provides several settings to control the frequency range it actually measures.

You can define the frequency range in various ways.

- In terms of a center frequency and the span around it.

- In terms of a start and stop frequency from which the center frequency is automatically derived.
- In terms of a channel table that contains (frequency) information about a set of transmission channels.
- [Measurement Frequency](#)..... 94
- [Frequency Span](#).....96
- [Channel Tables](#)..... 97

14.3.1 Measurement Frequency

The measurement frequency (or center frequency) is the frequency that the spectrum analyzer tunes to. It is represented by the frequency at the center of the x-axis in the diagram area.

If you know the (approximate) frequency of the signal you are measuring, you can simply match the frequency of the DUT to the center frequency and define an appropriate [span](#).

If you are measuring unknown signals within a greater frequency range, for example harmonics, it is better to define the frequency range based on [start and stop frequencies](#).

Defining a center frequency

1. Press the "Freq" key to open the frequency menu.
2. Select the "Center Freq" menu item.

The R&S FPC opens an input field to define the center frequency.

Tip: When you press the "Freq" key, the R&S FPC automatically opens an input field to define the center frequency. If the input field is inactive, you can open it with the "Center Freq" menu item.

3. Enter the required frequency.

The frequency you have entered becomes the new center frequency.

While adjusting the center frequency, you can obtain a value that is outside the R&S FPC maximum span. If this happens, the R&S FPC automatically reduces the span.

You can also define the frequency by selecting a specific transmission channel. In that case, the frequency is defined in a channel table. For more information, see ["Working with channel tables"](#) on page 97.

Defining a frequency step size

You can change the center frequency in fixed steps easily with the rotary knob or the cursor keys.

When you select the center frequency with the rotary knob or the cursor keys, the distance of each step that you take depends on the span. With the rotary knob, the smallest possible step is a pixel. With the cursor keys, the step is 10 % of the span or one division of the grid.

1. Press the "Freq" key to open the frequency menu.
2. Select the "CF Step Size" menu item to open the frequency step size menu.
3. Select one of step size options.
 - "0.1 x Span"
The step size equals 10 % of the span or 1 division of the horizontal axis.
 - "= Center"
The step size equals the center frequency.
This step size is ideal for measurements on harmonics. When you increase or decrease the center frequency, the center frequency automatically moves to the next harmonic.
 - "Manual <x> Hz"
Define any step size you want.
This step size makes it easy to investigate a spectrum with frequencies at constant intervals.

The R&S FPC adjusts the step size accordingly.

If you set the step size to 10 % of the span or to the center frequency, the R&S FPC sets the step size internally. Manually defining the step size opens an input field to define the step size.

Defining a frequency offset

A frequency offset allows you to shift the displayed frequency values by a certain amount to a higher or lower frequency. This shift is an arithmetical operation only - the measured frequency really remains the same.

Shifting the frequency to another value can be useful, for example, on frequency converting DUTs such as satellite downconverters. You are then able to display the original, unconverted input frequency of the DUT in the measurement results.

1. Press the "Freq" key to open the frequency menu.
2. Select the "Freq Offset" menu item.
The R&S FPC opens an input field to define the frequency offset.
3. Enter the required frequency offset.

The R&S FPC adds the frequency offset to the center frequency you have defined. A blue dot at the center frequency label indicates that a frequency offset is active.

You can define positive frequency offsets in the range from 1 Hz to 100 GHz in steps of 1 Hz. The maximum negative frequency offset depends on the start frequency you have defined. The start frequency, taking the frequency offset into account, is always ≥ 0 Hz.

14.3.2 Frequency Span

The span is the frequency range that the measurement covers. You can measure the full frequency range of the R&S FPC, or a smaller part of it. The span also defines which frequency information is displayed in the measurement diagram - the span is the frequency range around the **center frequency** that you have defined.

The available span for frequency domain measurements depends on the instrument model.

The span you should select depends on the bandwidth of the signal you are measuring and the type of measurement that you perform. A rule of thumb is to select a span that is at least twice as large as the bandwidth occupied by the measured signal.

You can define the span directly or in terms of a start and stop frequency.

Defining the frequency span

1. Press the "Freq" key to open the frequency menu.
2. Select the "Manual Span" menu item.

The R&S FPC opens an input field to define the span.

Tip: When you press the "Span" key, the R&S FPC automatically opens an input field to define the span. If the input field is inactive, you can open it with the "Manual Span" menu item.

3. Enter a span.

The R&S FPC adjusts the span of the horizontal axis to the value you have entered.

Tip: If you define a span of 0 Hz (zero span), the R&S FPC measures in the time domain.

In that state, the R&S FPC measures the signal at the current center frequency only. Instead of displaying the spectrum, the R&S FPC shows the signal power over a certain time period (like an oscilloscope). The horizontal axis becomes the time axis. The display always starts at 0 s and stops after the current sweep time.

You can select time domain measurements without having to enter the value manually. Instead, select the "Zero Span" menu item to get a span of 0 Hz.



Full span measurements

You can restore the span that covers the complete frequency range supported by the R&S FPC quickly and without having to enter the value manually with the "Full Span" menu item.

If you need to switch back to a smaller span, you can restore the span that was last selected with the "Last Span" menu item.

Defining a start and stop frequency

Defining a start a stop frequency is best suited for example for measurements on harmonics or signals whose exact frequency is unknown. When you define a start and stop frequency, the center frequency is automatically adjusted to be in the center of start and stop frequency.

1. Press the "Freq" key to open the frequency menu.
2. Select the "Start Freq" menu item.
The R&S FPC opens an input field to define the start frequency.
3. Enter a start frequency.
4. Select the "Stop Freq" menu item.
The R&S FPC opens an input field to define the stop frequency.
5. Enter a stop frequency.

Tip: If you have entered a stop frequency that is outside the maximum frequency range, the R&S FPC sets the stop frequency to the possible maximum.

The R&S FPC adjusts the horizontal axis according to your input, beginning with the start frequency and ending with the stop frequency.

The label of the horizontal axis changes from "Center" and "Span" to "Start" and "Stop".

14.3.3 Channel Tables

Working with channel tables

Almost all transmission systems divide their assigned frequency ranges into channels. Each channel corresponds to a specific frequency. To keep the handling of such systems simple, you can use channel tables instead of entering frequencies manually.

The R&S FPC already comes with an assortment of channel tables that you can use without doing anything. If you want to test transmission standards that are not listed, you can also create your own channel tables with the "Channel Table Editor" of the R&S InstrumentView software package. To use one of those, you just have to copy the channel table to the R&S FPC.

For more information, refer to the R&S InstrumentView user manual.

1. Press the "Freq" key to open the frequency menu.
2. Select the "Frequency Mode" menu item to open the frequency mode.
3. Select the "Channel Downlink" or "Channel Uplink" menu item.
The R&S FPC opens a dialog to select a channel table.
4. Select one of the available channel tables.

After activating the channel table, the R&S FPC is configured according to the information contained in the channel table. Instead of a center frequency, the R&S FPC shows the currently active channel number including the name of the channel. The center frequency of a channel is defined in the channel table and is the frequency corresponding to the selected channel.

Selecting a channel instead of a center frequency

When you have selected [frequency input in terms of channels](#), entering a center frequency, start or stop frequency is not possible anymore.

Instead you select a channel. The R&S FPC then adjusts the center, start and stop frequency according to the channel table.

1. Press the "Freq" key to open the frequency menu.
2. Select the "Center Frequency" menu item.

The R&S FPC opens an input field to select a specific channel.

3. Enter the channel you would like to analyze.

The R&S FPC changes the frequency according to the channel table and the channel you have selected.

Channel numbers are assigned to frequencies as follows.

- The first channel is assigned a channel number and a frequency.
- All subsequent channels have ascending numbers.
- The frequency spacing between channels is fixed. It can also be negative. In that case, the center frequency of the R&S FPC decreases with ascending channel numbers.
- In transmission systems containing gaps in the frequency range (as in the case of television, for example), a channel table can comprise multiple ranges.

14.4 Amplitude Configuration

Access: "Ampt"

Access: "Setup" > "Config Overview" > "Amplitude" (selected settings)

In addition to measuring the frequency of a signal, the other main function of a spectrum analyzer is to measure level characteristics of the signal.

The R&S FPC provides several settings that have an effect on the way the level is measured and how level values are displayed.

Remote commands to configure the amplitude:

- [Chapter 19.12.3, "Amplitude"](#), on page 252

Selecting the input impedance

The RF input has an impedance of 50 Ω .

If you need an input impedance of 75 Ω , you have to connect one of the supported matching pads to the RF input. When one of the supported matching pads is connected, you can change the input impedance. The R&S FPC in that case automatically considers the conversion factor.

The matching pads are available as accessories. Refer to the datasheet for ordering information.

1. Press the "Ampt" key to open the amplitude menu.
2. Select the "Impedance" menu item to open the impedance menu.
3. Select the input impedance you need.

In addition to the "50 Ω " impedance, you can select a 75 Ω when one of the supported matching pads is connected. The R&S FPC supports the following matching pads: "75 Ω RAM", "75 Ω RAZ" or "75 Ω FSH-Z38".

• Reference Level	99
• Measurement Sensitivity	101
• Scale of the Y-Axis	103
• Transducers	104

14.4.1 Reference Level

The reference level is the signal level that the analyzer expects at the RF input. In fact, it should be slightly higher than the expected level of the signal you are measuring. If necessary, the analyzer also attenuates or amplifies the signal to yield the best possible dynamic range.

When you define a low reference level (meaning that a weak signal is expected), the analyzer amplifies the signal internally to display even weak signals clearly. On the other hand, when you apply a strong signal (or an unknown signal), you have to make sure to define a reference level high enough for that signal to prevent an overload situation in the signal path. A high reference level also keeps the displayed signal within the display range.

If you are measuring the spectrum of a composite signal, make sure that the reference level is high enough to cover all signals and that all signals are within the [display range](#).

In the measurement diagram, the reference level is represented by the topmost grid line.

Defining a reference level

1. Press the "Ampt" key to open the amplitude menu.
2. Select the "Reference Level" menu item.

The R&S FPC opens an input field to define the reference level.

Tip: When you press the "Ampt" key, the R&S FPC automatically opens an input field to define the reference level. If the input field is inactive, you can open it with the "Reference Level" menu item.

3. Enter the reference level.

When you change the reference level while a trace is already displayed, the R&S FPC adjusts the position of the trace.

The current reference level is indicated in the status bar. A blue dot in front of the "Ref:" label indicates a [reference level offset](#) is active.

Defining a reference offset

The reference level offset is an arithmetic level offset. It shifts the measured levels by a certain amount and changes the scale of the y-axis accordingly.

Such an offset is useful, for example, if you insert an external attenuator or amplifier between DUT and RF input. The R&S FPC automatically takes the loss or gain into account when the level is displayed - no manual calculations are necessary. A loss introduced at the RF input must be entered as a positive number, a gain as a negative number.

Note, however, that the internal reference level (used to adjust the hardware to the expected signal) ignores the reference offset. Thus, it is important to keep in mind the actual power level that the R&S FPC must handle. Do not rely on the displayed reference level (internal reference level = displayed reference level - offset).

1. Press the "Ampt" key to open the amplitude menu.
2. Select the "Range / Ref Position" menu item to open the display range menu.
3. Select the "Reference Offset" menu item.

The R&S FPC opens an input field to define the reference offset.

4. Enter the required reference level offset.

The R&S FPC adjusts the position of the trace and scale of the y-axis as you apply the changes.

A blue dot in front of the "Ref:" label in the status bar indicates that a level offset is active.



Figure 14-7: Indicator of a reference level offset

Defining the position of the reference level

By default, the reference level the grid line at the top of the diagram represents the reference level. The current reference level position is indicated by a small grey triangle on the y-axis.



Figure 14-8: Indicator of reference level position

You can change the position of the reference level to another grid line, if required for any reason.

1. Press the "Ampt" key to open the amplitude menu.
2. Select the "Range / Ref Position" menu item to open the display range menu.
3. Select the "Reference Position 10 ..." menu item.

The R&S FPC opens an input field to define the reference position.

4. Enter the number of the grid line (0 to 10) you want the reference level at. "0" corresponds to the grid line at the bottom of the diagram. "10" corresponds to the grid line at the top of the diagram.

The R&S FPC adjusts the position of the trace accordingly.

14.4.2 Measurement Sensitivity

The R&S FPC provides several ways to improve (control) the sensitivity of a measurement.

RF attenuator

The internal RF attenuator is a hardware component to control measurement sensitivity.

It is coupled directly to the reference level and has the following effects.

- High attenuation protects the input mixer. Protecting the input mixer is the main purpose of the attenuator.
- High attenuation makes sure that the measurement results are reliable. Signals that are stronger than allowed might distort the results.
- High attenuation increases inherent noise (i.e. the noise floor) and thus decreases measurement sensitivity: if you increase attenuation by 10 dB, the sensitivity is reduced by 10 dB (in other words: the displayed noise increases by 10 dB).
- High attenuation helps to avoid intermodulation.

Depending on the required test setup, a compromise must be found between a high sensitivity, low intermodulation and input mixer protection. This is best done by letting the R&S FPC determine the ideal attenuation automatically. Determining the attenuation automatically might not necessarily utilize the maximum dynamic range, but still yields valid and reliable results.

When you select the attenuation manually and are measuring unknown signals, especially DUTs with a high RFI voltage, always select the highest possible attenuation level before you apply the signal.

If you need a better sensitivity or signal-to-noise ratio, make sure that the applied signal does not exceed the specified limits, before you lower the attenuation.

Defining RF attenuation

1. Press the "Ampt" key to open the amplitude menu.

2. Select the "Attenuator" menu item to open the attenuator menu.
3. The R&S FPC provides several attenuation modes.
 - "Manual Att <x> dB"

Defines the attenuation manually in 5 dB steps. The range is from 0 dB to 40 dB.

Manual attenuation is indicated by a blue dot in front of the "Att:" display in the status bar.

ATT: 5 dB

Figure 14-9: Indicator of manual attenuation

- "Auto Low Distortion"

Selects an attenuation and gain that results in a good signal-to-noise ratio. Thus, it reduces the display of spurious products. It also leads to an increased display of the inherent noise (because of a higher attenuation).

See [Table 14-1](#) for the dependencies between reference level and applied attenuation.
- "Auto Low Noise"

Selects an attenuation and gain that increases the sensitivity of the R&S FPC. This mode gives a better impression of spurious products and is thus useful to analyze signals whose level is near the noise level. However, the signal-to-noise ratio in general can deteriorate.

See [Table 14-1](#) for the dependencies between reference level and applied attenuation.

The current attenuation is indicated in the measurement settings.

Table 14-1: Dependencies of the selected reference levels and attenuation

Reference level	Preamplifier OFF RF attenuation		Preamplifier ON RF attenuation	
	Low noise	Low distortion	Low noise	Low distortion
≤-30dBm	0 dB	0 dB	0 dB	0 dB
-29 dBm to -25 dBm	0 dB	0 dB	0 dB	5 dB
-24 dBm to -20 dBm	0 dB	0 dB	0 dB	10 dB
-19 dBm to -15 dBm	0 dB	5 dB	5 dB	15 dB
-14 dBm to -10 dBm	0 dB	10 dB	10 dB	20 dB
-9 dBm to -5 dBm	5 dB	15 dB	15 dB	25 dB
-4 dBm to 0 dBm	10 dB	20 dB	20 dB	30 dB
1 dBm to 5 dBm	15 dB	25 dB	25 dB	35 dB
6 dBm to 10 dBm	20 dB	30 dB	30 dB	40 dB
11 dBm to 15 dBm	25 dB	35 dB	35 dB	40 dB
16 dBm to 20 dBm	30 dB	40 dB	40 dB	40 dB

Reference level	Preamplifier OFF RF attenuation		Preamplifier ON RF attenuation	
	Low noise	Low distortion	Low noise	Low distortion
21 dBm to 25 dBm	35 dB	40 dB	40 dB	40 dB
26 dBm to 30 dBm	40 dB	40 dB	40 dB	40 dB

Preamplifier

The internal 20 dB preamplifier is another hardware component to control measurement sensitivity.

When you turn on the preamplifier, all signals are amplified by 20 dB.

It has the following effects on measurements.

- The preamplifier allows you to detect even weak signals.
- The preamplifier reduces the noise figure of the R&S FPC and thus increases its sensitivity. Thus, it is recommended to use the preamplifier for measurements that require a high sensitivity.
- The preamplifier reduces the dynamic range. If you want to measure with the maximum dynamic range, you should turn off the preamplifier.

The gain of the preamplifier is automatically considered in the level display.

Turning the preamplifier on and off

1. Press the "Ampt" key to open the amplitude menu.
2. Select the "Preamp" menu item.

The R&S FPC turns the preamplifier on and off.

The status of the preamplifier is indicated in the status bar.

14.4.3 Scale of the Y-Axis

The scale of the y-axis depends on the unit you have selected for the measurement and the display range.

Selecting the display unit

A spectrum analyzer usually shows signal levels in the unit dBm.

If necessary, you can also select other units. In that case, the analyzer automatically converts the results into the selected unit.

1. Press the "Ampt" key to open the amplitude menu.
2. Select the "Unit" menu item to open the unit menu.
3. Select the one of the available display units.

The R&S FPC adjusts the labels of the vertical axis accordingly.

Defining a display range

The display range determines the scale or resolution of the y-axis.

In the default state, the display range is a logarithmic scale over a 100 dB. This scale corresponds to a resolution of 10 dB per grid division. The R&S FPC provides other display ranges that either increase or decrease the resolution of the y-axis.

Note that increasing the resolution of the y-axis does not increase the accuracy of measurement results. It merely makes it easier to read the values of the trace.

You can also select a linear scale for the vertical axis. In that case, the power levels are expressed as a percentage of the reference level. A linear scale is useful, for example, to display AM modulated carriers in the time domain.

1. Press the "Ampt" key to open the amplitude menu.
2. Select the "Range / Ref Position" menu item to open the display range menu.
3. Select the display range you need.
 - "Auto Range"
Automatically scales the y-axis for an ideal display of the measured signal.
 - "Range <x> dB"
Opens an input field to define a custom display range.
 - "Linear 0 - 100 %"
Changes the scale into a linear scale.
Note that "Auto Range" is not supported for a linear y-axis scale.

The R&S FPC adjusts the vertical axis accordingly.

14.4.4 Transducers

The results of measurements with transducers or antennas usually need to be corrected by their frequency characteristics. These correction values are defined in transducer factors. When you use a transducer factor, these correction values can be directly considered in the measurement results.

A transducer factor consists of several data points, with each data point being defined by a frequency and the corresponding correction value for that frequency. The unit of the correction value depends on the transducer you are using. Field-strength measurements with an antenna, for example, indicate the electrical field strength in dB μ V, so the transducer factor has to define its level values in dB μ , too.

You can also use a transducer factor to correct a frequency-dependent attenuation, e.g. of a cable between DUT and RF input of the R&S FPC.

You can create and edit transducer factor with the R&S InstrumentView software package and then transfer them into the internal memory of the R&S FPC. Each transducer factor can consist of up to 1000 reference values.

Interpolation between the values is performed with the aid of a modified spline algorithm. Even if only relatively few values such as maxima, minima and turning points are available, this algorithm can easily simulate the correction factors of common transduc-

ers. Two transducers can be switched on at a time. The second transducer must be assigned the unit dB. The R&S FPC adds the two transducers to a total transducer.

Units supported for transducer factors:

- dB
- dB μ V/m
- dB μ A/m
- W/m²

The unit dB does not change the unit set on the R&S FPC. It can be used, for example, to compensate for frequency-dependent loss and gain at the input of the R&S FPC. The units dB μ V/m and dB μ A/m convert the output power of an antenna into electric or magnetic field strength. The unit W/m² is used to calculate and display the power flux density.

For example, to compensate for the cable loss between the transducer and the RF input, the R&S FPC can use two transducers at the same time. One of them must have the unit dB, however, i.e. it must correspond to one loss or gain value.

Selecting transducer factors

1. Press the "Ampt" key to open the amplitude menu.

2. Select the "Transducer" menu item to open the transducer menu.

Note: You can select two transducer factors, a primary transducer and a secondary transducer.

3. Select the "Select Primary" menu item.

The R&S FPC opens a submenu where you can select the transducer factor you need.

4. Select the transducer factor you need and confirm the selection with the "Load" menu item.

The R&S FPC applies the correction values to the measurement results.

An example would be the transducer factor of the R&S HL223 antenna that is defined between 200 MHz and 1300 MHz. The R&S FPC therefore displays the noise in this frequency range as a function of frequency incremented by the transducer factor. Outside the transducer range, the R&S FPC sets the transducer factor at zero, i.e. measurements in this range do not yield conclusive results.

You can select a second transducer factor with the "Select Secondary" menu item. The secondary transducer factor in that case is added to the first. The unit of the second transducer factor must always be the relative unit dB as otherwise an addition would not be useful. When you select a secondary transducer factor, the dialog box shows only those transducer factors that have dB as their unit.

Setting the unit for measurements with transducers

If the unit of the transducer is dB, the units dBm, dBmV or dB μ V remain unchanged. The linear units volt and watt are not allowed. They are deactivated in the units menu.

If the unit of the transducer is dB μ V/m or dB μ A/m, this unit is also used for the R&S FPC level display. This means that both the level axis of the diagram and the level at the marker position are assigned the unit of the transducer. If dB μ V/m is selected as the transducer unit, a switch to absolute level indication in V/m is possible.

1. Press the "Ampt" key to open the amplitude menu.
2. Select the "Unit" menu item to open the unit menu.
3. Select the unit you need (note that you can select only units compatible to the transducer factor).

The R&S FPC applies the selected unit.

Tip: If you are using a transducer with the unit dB μ A/m, it is not possible to select another unit. Level indication is entirely in dB μ A/m.

Defining the reference level

The transducer shifts the trace by its value as a function of frequency. Positive transducer values increase the level, negative values reduce it. To ensure that the trace is always within the diagram, the R&S FPC adjusts the reference level accordingly. The reference level is shifted by the maximum transducer value in the positive or negative direction.

Frequency range of transducer

If the set frequency range is wider than the span in which a transducer is defined, the R&S FPC assumes the transducer values outside the defined range to be zero.

Data sets containing transducer factors

The R&S FPC stores data sets together with any transducer factors that may have been active for the measurement in question. When such a dataset is recalled, the associated transducer factor(s) are switched on as well. Transducer factors recalled as part of a data set do however not appear in the list of transducer factors.

14.5 Bandwidth Configuration

Access: "BW"

Access: "Setup" > "Config Overview" > "Bandwidth" (selected settings)

Remote commands to configure the bandwidth:

- [Chapter 19.12.4, "Bandwidth"](#), on page 259

A spectrum analyzer has two main filters, the resolution filter and the video filter, that affect the measurement results. The bandwidth of these filters should be selected based on your measurement task.

- [Resolution Filter](#)..... 107
- [Video Filter](#)..... 108

14.5.1 Resolution Filter

The resolution filter (or IF filter) is a 3 dB bandpass filter located in the IF path of the analyzer. Its bandwidth determines how well individual spectral components can be separated from each other in frequency domain measurements.

The resolution bandwidth (RBW) has several effects on measurements.

- **Selectivity**
Measuring and displaying two or more spectral components whose frequencies are close together requires a resolution filter bandwidth (RBW) small enough to resolve these components. Otherwise they will be displayed as a single component. Two signals with the same amplitude can be resolved if the resolution bandwidth is smaller than or equal to the frequency spacing of the signal. The highest selectivity is obtained at the smallest bandwidth. If the bandwidth is increased, the reduction in selectivity is proportional to the change in bandwidth.
- **Noise**
The bandwidth of the resolution filter affects the noise that is displayed by the R&S FPC. The smaller the bandwidth, the less noise is visible. Increasing the bandwidth by a factor of 3 increases the displayed noise by approx. 5 dB (4.77 dB precisely). Increasing the bandwidth by a factor of 10, increases the displayed noise by a factor of 10 (10 dB).
- **Measurement speed**
The resolution bandwidth affects the speed of the measurement. If you want to display the true spectrum, the resolution filters have to settle at all frequencies that are of interest. Narrow filters have a longer settling time compared to wide ones. Therefore the [sweep time](#) increases the smaller the resolution bandwidth gets. Reducing the bandwidth by a factor of 3, increases the measurement time by a factor of 9. Reducing the bandwidth by a factor of 10, increases the measurement time by a factor of 100.

Setting the resolution bandwidth

1. Press the "BW" key to open the bandwidth menu.
2. Select one of the "RBW: <x>" menu items.
 - "RBW: Manual"
Opens an input field to select one of the available bandwidths. If you enter a bandwidth that the R&S FPC does not support, the R&S FPC rounds to the next available bandwidth. Refer to the data sheet for more information on available resolution bandwidths. Note that you have to select the 200 kHz bandwidth manually with the number keys. This bandwidth will neither be selected when "RBW: Auto" is on, nor will it be selected when you use the rotary knob or cursor keys. A manually selected RBW is indicated by a blue dot in front of the "RBW" label in the status bar.

 - "RBW: Auto"

Figure 14-10: Indicator of manual resolution bandwidth

Automatically selects an appropriate resolution bandwidth depending on the current [frequency span](#).



Automatic adjustment of the sweep time

In its default mode, the R&S FPC automatically adjusts the sweep time when you change the resolution bandwidth. This ensures that the settling time required for the selected resolution filter is properly taken into account.

For narrow resolution filters and large spans, the maximum sweep time would be exceeded. To avoid this, the R&S FPC adjusts the span automatically as soon as the maximum sweep time is reached.

14.5.2 Video Filter

The video filter is a lowpass filter located after the [envelope detector](#) which filters the higher frequency parts of the voltage from the signal. This process makes the trace smoother and makes it easier to read out level values.

Video voltage is the (DC) voltage that results from the IF signal passing through the envelope detector which removes the IF components and outputs the envelope only. This output is also known as the video signal.

The figure below shows that process on an AM modulated signal in the time domain.

In case of an AM modulated signal, the envelope (or video) signal contains a DC component that corresponds to the level of the carrier. The video signal also contains an AC component whose frequency is the same as the AM frequency.

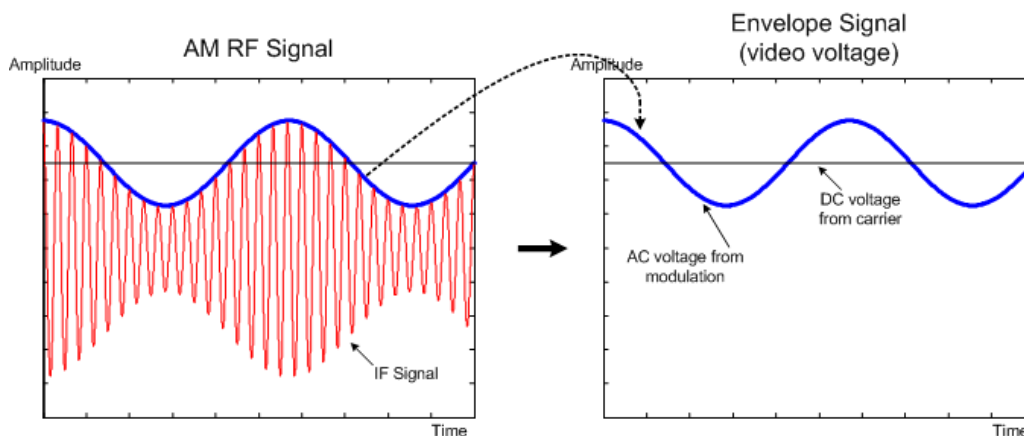

Figure 14-11: Video voltage of an AM signal

If the video filter bandwidth is less than the frequency of the AC component, it is suppressed depending on its maximum frequency. If the AM component should be displayed truly, the cutoff frequency of the filter has to be greater than the modulation frequency.

If there is noise on the sine signal, the modulation signal can be thought of as noise. If the video bandwidth is reduced, the high-frequency noise components above the cutoff

frequency of the video filter will be rejected. The smaller the video bandwidth, the smaller the noise amplitude at the video filter output.

The video bandwidth (VBW) has several effects on measurements.

- If you want to keep signals free of noise, you should select the smallest video bandwidth possible ($\leq 0.1 \times \text{RBW}$).
- When you are measuring modulated signals, the video bandwidth must be sufficiently large so that significant modulation components are not rejected ($\geq \text{RBW}$).
- When you are measuring pulsed signals, the video bandwidth should be at least three times higher than the resolution bandwidth so that the pulse edges are not distorted.

Setting the video bandwidth

1. Press the "BW" key to open the bandwidth menu.
2. Select one of the "RBW: <x>" menu items.
 - "VBW: Manual"

Opens an input field to select one of the available bandwidths.
If you enter a bandwidth that the R&S FPC does not support, the R&S FPC rounds to the next available bandwidth. Refer to the data sheet for more information on available resolution bandwidths
A manually selected VBW is indicated by a blue dot in front of the "VBW" label in the status bar.



Figure 14-12: Indicator of manual video bandwidth
 - "VBW: Auto"

Automatically selects an appropriate video bandwidth depending on the current resolution bandwidth.
3. Enter the required video bandwidth.
The R&S FPC uses the video bandwidth you have entered for the measurement.

14.6 Sweep Configuration

Access: "Sweep"

Remote commands to control the sweep:

- [Chapter 19.12.5, "Sweep Control"](#), on page 261

"Sweep" is another word for the measurement process of the spectrum analyzer (traditional spectrum analyzers have a tunable local oscillator that "sweeps" across the frequency spectrum to determine the frequency characteristics of the applied signal).

- [Sweep Time](#)..... 110
- [Sweep Mode](#)..... 110
- [Sweep Type](#)..... 111

14.6.1 Sweep Time

The sweep time (or measurement time) is the time that the analyzer requires to acquire and analyze the data in the selected [frequency span](#). Large spans require more time to measure than small spans. Generally, the R&S FPC requires at least 20 ms for every 600 MHz of span.

In addition to the frequency span, the measurement time also depends on the selected [resolution bandwidth](#): smaller resolution bandwidths require more time to settle than large ones. If the measurement time is too short, the resolution filter has no time to settle. In that case, the displayed levels will be too low.

In its default state, the R&S FPC automatically selects a measurement time that makes sure that the measurement results for the selected span and resolution bandwidth are correct and valid. If you change span or resolution bandwidth, the R&S FPC adjusts the measurement time accordingly.

In the time domain (span = 0), the R&S FPC shows the video voltage over time. The horizontal axis becomes a time axis that starts at 0 s and ends at the measurement time that you have selected.

Defining the sweep time

1. Press the "Sweep" key to open the sweep menu.
2. Select one of the "Sweep time: <x>" menu items.
 - "Sweep time: Manual"
Opens an input field to define the measurement time.
A manually selected measurement time is indicated by a blue dot in front of the "SWT" label in the status bar.



Figure 14-13: Indicator of a manual sweep time

If you define a sweep time that is lower than the automatic sweep time, the dot in front of the "SWT" label and the sweep time display turn red.



Figure 14-14: Indicator of a low sweep time

- "Sweep time: Auto"
Automatically selects an appropriate measurement time depending on the current [frequency span](#) and [resolution bandwidth](#).

Tip: When you press the "Sweep" key, the R&S FPC automatically opens an input field to define the sweep time. If the input field is inactive, you can open it with the "Sweep time: Manual" menu item.

14.6.2 Sweep Mode

The sweep mode defines how often the analyzer measures the frequency spectrum.

In continuous mode, the R&S FPC repeats the measurement of the selected span over and over until you stop it deliberately. The measurement results are updated accordingly.

In single sweep mode, the R&S FPC measures the frequency spectrum once and then stops without updating the results any longer. Another measurement starts only when you deliberately initiate it. Note that in case of the [average trace mode](#), a single sweep can consist of several measurements - when these are done, the measurement stops.

Selecting the sweep mode

1. Press the "Sweep" key to open the sweep menu.
2. Select the "Continuous Sweep" menu item.

The R&S FPC starts a continuous measurement of the selected [span](#).

You can interrupt a continuous measurement by selecting the "Continuous Sweep" menu item again.

3. Select the "Single Sweep" menu item.

The R&S FPC starts a single measurement of the selected [span](#).

14.6.3 Sweep Type

The sweep type defines the way how the R&S FPC captures and processes the data. The sweep type also has an effect on the measurement speed.

Selecting the sweep type

1. Press the "Setup" key to open the setup menu.
2. Select the "User Preference" menu item.
3. Select the "Sweep / FFT Mode" menu item in the "Spectrum" category.
4. Select the sweep type from the dropdown menu.

The appropriate sweep type for your measurement setup depends on the span, RBW, VBW and sweep time settings.

- "Auto"
The R&S FPC automatically selects the fastest sweep type for the current measurement configuration.
- "Always Sweep"
The R&S FPC uses the local oscillator to provide the spectrum quasi analog from the start to the stop frequency (analog sweep).
- "Prefer FFT"
The R&S FPC samples the signal levels over time on a defined frequency value and transforms it to the spectrum by fast Fourier transformation (FFT).

Note that an FFT sweep is not possible under the following circumstances:

- For measurements in the time domain (zero span).

- For TDMA Power measurements.
- For measurements with a gated trigger.
- If the frequency span is smaller than the resolution bandwidth (RBW).
- If the the resolution bandwidth (RBW) is greater than 300 kHz.

14.7 Trigger Configuration

Access: "Sweep"

Access: "Setup" > "Config Overview" > "Trigger" (selected settings)

Remote commands to trigger measurements:

- [Chapter 19.12.6, "Trigger"](#), on page 264

It often makes sense to capture data only when interesting events occur in the spectrum or only capture parts of a signal. In such cases, you can use a trigger. A trigger responds to certain events. When you use a trigger, the analyzer starts a measurement only when certain trigger conditions are met.

Selecting the trigger source

The trigger source selects the type of event whose condition must be met to start data acquisition.

1. Press the "Sweep" key to open the sweep menu.
2. Select the "Trigger" menu item to open the trigger menu.
3. Select one of the trigger sources.
 - "Free Run"
No trigger source is considered. You can start the measurement manually any time and stop it as required.
 - "Video Trigger"
A measurement starts when the voltage of the video signal exceeds a certain level.
When you select the video trigger, the R&S FPC opens an input field to define the trigger level that the video signal must meet or exceed. The video trigger level is a percentage of the diagram height (0 % to 100 %). A small symbol on the diagram's y-axis (■) indicates the absolute trigger level.
The video trigger is available for time domain measurements (span = 0). (In the frequency domain, a measurement would never start with the video trigger because there is no guarantee that there is a signal that generates video voltage at the start frequency.)
 - "External Rise" / "External Fall"
A measurement starts on the rising or falling edge of an external trigger signal.
"External Rise": the measurement starts when the trigger signal rises above 1.4 V (a TTL signal level).

"External Fall": the measurement starts when the trigger signal falls below 1.4 V (a TTL signal level).

You can connect the external trigger source to the corresponding BNC connector on the rear panel of the R&S FPC.

Note that the BNC connector has to be configured as a [trigger input](#) in the instrument setup.

Tip: As long as the measurement hasn't started, the R&S FPC displays "Waiting for Trigger" in the diagram area.

Defining a trigger delay

When you are using an external trigger, you can delay the start of the measurement with respect to the trigger event. Thus, you can include time differences between the trigger event and the measurement.

1. Press the "Sweep" key to open the sweep menu.
2. Select the "Trigger" menu item to open the trigger menu.
3. Select the "Trigger Delay" menu item.

The R&S FPC opens an input field to define the delay time.

The range of the trigger delay is between 0 μ s to 100 s. The resolution with which you can select the delay time depends on the subrange of the delay time (see [Table 14-2](#)).

Table 14-2: Trigger delay dependencies

Trigger delay	Resolution
0 s to 1 ms	10 μ s
1 ms to 10 ms	100 μ s
10 ms to 100 ms	1 ms
100 ms to 1 s	10 ms
1 s to 10 s	100 ms
10 s to 100 s	1 s

14.8 Trace Configuration

Access: "Trace"

Access: "Setup" > "Config Overview" > "Analysis" (selected settings)

Remote commands to configure traces:

- [Chapter 19.12.7, "Traces"](#), on page 265

The trace is the graphical representation of the measured spectrum. In the diagram, it is represented by a colored graph. Depending on the trace configuration, the R&S FPC evaluates and displays the measurement data differently.

Selecting a trace

The R&S FPC can display up to two traces at the same time, each with a different configuration.

Before you configure a trace, you have to select the trace whose attributes you would like to change.

1. Press the "Trace" key to open the trace menu.
2. Select the "Select Trace" menu item.
The currently selected trace number is highlighted.

Selecting a second trace

The R&S FPC can display two traces. Both traces are based on the same settings, except the trace settings like the [trace mode](#) or the [detector](#). You can use the second trace to compare, for example, two different detector settings.

In the default state, only trace 1 is active.

1. Press the "Trace" key to open the trace menu.
2. Select the "Trace <x>" menu item.
The R&S FPC activates the second trace which has a different color than the first trace.
After you have activated the second trace, this is also the active one. All actions (like changing the detector or trace mathematics) apply to the active trace.
3. By default, the second trace has the trace mode "Blank". Before you can see it, you have to select a different trace mode for the second trace.
4. Select the detector for the second trace.

The R&S FPC updates both traces based on their respective settings. The trace information above the diagram area shows the settings for both traces.

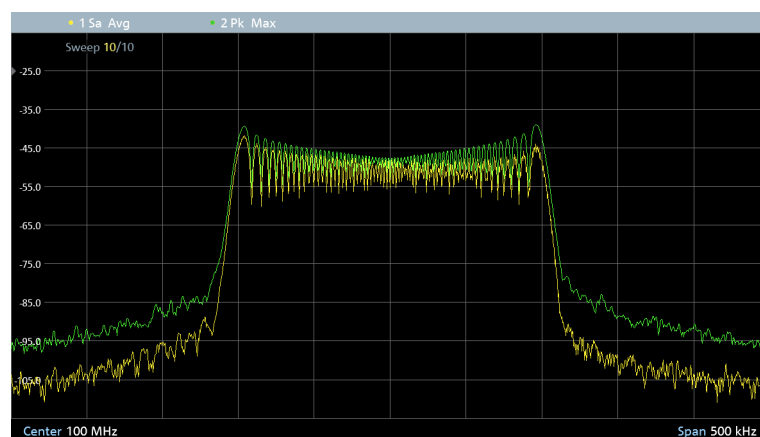

Figure 14-15: Display of two traces with trace information above the diagram area

• Trace Mode	115
• Detector	116
• Memory Traces	117

14.8.1 Trace Mode

The trace mode determines the way the R&S FPC writes or displays the trace or which results are displayed.

Note that each time you select another trace mode, the R&S FPC clears the trace memory.

The following trace modes are available.

- "Clear / Write"
Overwrites the displayed measurement results when you start a new sweep. Selecting the "Clear / Write" mode automatically selects the "Auto Peak" [detector](#).
- "Max Hold"
Displays the highest levels that have been measured over several sweeps. Selecting the "Max Hold" trace mode automatically selects the "Max Peak" [detector](#).
To overwrite a max hold trace, change a parameter in a way that the results cannot be compared any more, for example the span.
The "Max Hold" trace mode is a good way to detect intermittent signals or the maximum values of fluctuating signals, for example.
- "Min Hold"
Displays the lowest levels that have been measured over several sweeps. Selecting the "Min Hold" trace mode automatically selects the "Min Peak" [detector](#).
To overwrite a max hold trace, change a parameter in a way that the results cannot be compared any more, for example the span.
The "Min Hold" trace mode is a good way to highlight signals within noise or suppress intermittent signals.
- "Average"
Displays the average levels that have been measured over several sweeps. The "Average" trace mode calculates the (moving) average of the power levels for each pixel over several sweeps.
Averaging reduces the effects of noise, but has no effects on sine signals. The "Average" trace mode is a good way to detect signals in the vicinity of noise. Selecting the "Average" trace mode automatically selects the "Sample" [detector](#).
- "View"
Freezes the displayed results without updating them any longer. The view trace mode is a good way to evaluate the trace, for example with markers.
Changing measurement settings while the trace is in "View" mode has no impact on the displayed trace. The only exception is when you change the scale of the x-axis - in that case, the R&S FPC writes a new trace. The fact that the displayed trace no longer matches the current measurement settings is indicated by an asterisk (★) in the diagram.
- "Blank"

Removes the trace from the diagram.

Selecting the trace mode

1. Press the "Trace" key to open the trace menu.
2. Select the "Trace Mode" menu item to open the trace mode menu.
3. Select the trace mode you want to work with.

If you have selected the average trace mode ("Average" menu item), the R&S FPC opens an input field to define the number of measurements included in the averaging ("Average Count").

4. Enter the number of sweeps to include in the averaging.

In continuous sweep mode, the R&S FPC now calculates the moving average over the number of sweeps you have specified. In single sweep mode, it stops the measurement after finishing the sweeps and averages the traces.

14.8.2 Detector

The number of samples collected in a single sweep usually is very large, especially if the span is large. However, the display of the R&S FPC can display only a limited number of results on the y-axis, because it is limited by the display resolution (one pixel usually combines a large quantity of measurement points). Therefore, it has to reduce the data and combine measurement results to fit them on the display.

The detector determines the way the R&S FPC combines and displays the results for one pixel. The data base is the video voltage of the analyzer.

The following detectors are supported.

- "Auto Peak"
The auto peak detector displays both the highest and the lowest power levels that were measured in the frequency range covered by a pixel.
The auto peak detector loses no information. If a signal's power level fluctuates (for example in case of noise), the width of the trace depends on the magnitude of the signal fluctuation.
- "Max Peak"
The max peak detector displays only the highest level that was measured in the frequency range covered by a pixel.
The max peak detector is useful for measurements on pulses or FM signals, for example.
- "Min Peak"
The min peak detector displays only the lowest level that was measured in the frequency range covered by a pixel.
The min peak detector displays sine signals with the correct level and suppresses noise. Therefore it is useful to find sine signals in the vicinity of noise.
- "RMS"

The RMS detector measures the spectral power over one pixel. In case of power measurements, the RMS detector always shows the true power of a signal, regardless of the shape of the signal.

The RMS detector is best for measurements on digitally modulated signals because it provides stable and true power readings. In combination with a high sweep time, you can increase the display stability even more because the measurement time for each pixel increases.

Noise measurements also provide stable results if you apply the RMS detector in combination with a high sweep time.

However, the bandwidth occupied by the signal to be measured should at least equal the frequency covered by a trace pixel or the selected resolution bandwidth (whichever is larger). Otherwise, the power the R&S FPC shows is too low because there are spectral components within the frequency range covered by the pixel that do not originate from the signal you want to observe (e.g. noise).

To get the true power, the video bandwidth (VBW) should also be greater than the resolution bandwidth (RBW). Otherwise, an averaging effect caused by video bandlimiting comes into play before the RMS value is calculated.

- "Sample "
The sample detector shows the last level that was measured in the frequency range covered by a pixel.
The sample detector is useful for measurements in the time domain (span = 0 Hz) as it provides the only way to represent the timing of the video signal correctly. In the frequency domain, the sample detector is a good way to measure noise power because noise usually has a uniform spectrum with a normal amplitude distribution.
Signals can get lost if you are using the sample detector for measurements with a span that is greater than $RBW \cdot 1183$ (number of display points).
- "Auto Detector"
The auto detector selects one of the detectors automatically, depending on the selected trace mode.
For more information, see [Chapter 14.8.1, "Trace Mode"](#), on page 115.

Selecting the detector

1. Press the "Trace" key to open the trace menu.
2. Select the "Detector" menu item to open the detector menu.
The R&S FPC opens a submenu to select the detector mode.
3. Select the detector you want to work with.

14.8.3 Memory Traces

Working with memory traces

You can save the image of both traces to the memory of the R&S FPC and later restore it, compare it to a live trace or apply trace mathematics. The memory trace has a different shade of color to distinguish it from the live traces. In the spectrum application, the R&S FPC supports three memory traces.

When you save a data set, the R&S FPC also stores the associated trace in the trace memory. If you restore it later, you can display the memory trace as if it is a normal trace.

1. Press the "Trace" key to open the trace menu.
2. Select the trace you want to store in the trace memory with the "Select Trace" menu item.

The R&S FPC saves the selected trace.

3. Select the "Memory Traces" menu item.
4. Select the "Trace ► Memory <x>" menu item.

The R&S FPC stores the trace data in its memory. The "Memory" menu item becomes active.

5. Select the "Show Memory <x>" menu item.

The R&S FPC shows the memory trace in a different shade of the corresponding trace color. If active, it highlights the "Show Memory <x>" menu item.

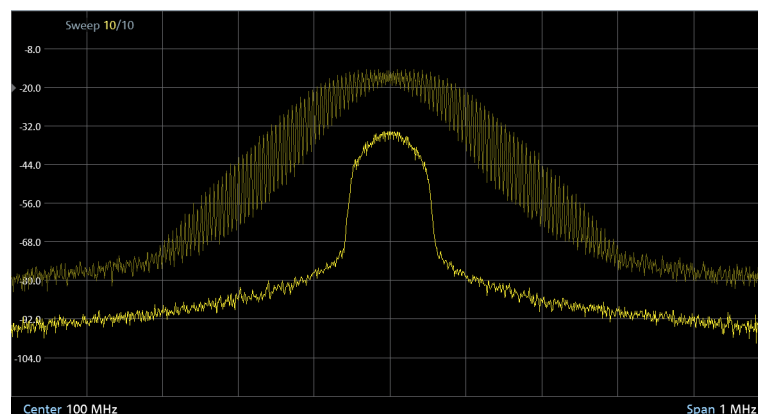

Figure 14-16: Trace (bright yellow) and memory trace (pale yellow)

Using trace mathematics

Trace mathematics subtract the memory trace from the live trace and vice versa and then display the results.

1. Press the "Trace" key to open the trace menu.
2. Select the "Trace ► Memory" menu item.

The R&S FPC saves the selected trace.

3. Select the "Trace Math" menu item.

The R&S FPC opens a submenu to select mathematical operations to be applied to the traces.

4. Select the "Trace - Memory " or the "Memory - Trace " menu item.

The R&S FPC calculates and shows the resulting trace (the memory trace remains as it is, the result is written to the active trace).

Tip: To turn off trace mathematics, select the "Off" menu item. If trace mathematics is active, the resulting trace can be adjusted in its position by selecting the "Math Position" menu item.

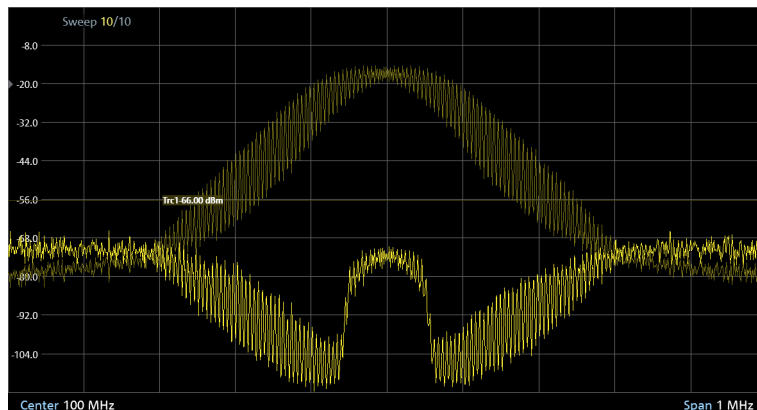

Figure 14-17: Result of trace mathematics ("Trace - Memory")

14.9 Marker Configuration

Access (marker menu): "Mkr"

Access (marker positioning menu): "Mkr→"

Remote commands to control marker:

- [Chapter 19.12.8, "Marker"](#), on page 271

Markers are a tool that can help you to determine signal characteristics for each measurement point displayed on the trace. They indicate the horizontal and vertical coordinates of trace points, for example the frequency and level measured at a certain trace point.

The R&S FPC has six markers, five of which can be used as either markers or delta markers. Markers show absolute values, delta markers show values relative to the first marker (marker 1 or "M1"). The first marker (reference marker) is always a normal marker.

The horizontal position of a marker is represented by a vertical line which extends from the top to the bottom of the diagram area (continuous lines for markers and dotted lines for delta markers). The R&S FPC also draws a marker icon at the bottom of the line to indicate the position of the marker (M1). The currently selected marker is indicated by a line drawn around the icon (M1). The icon also contains information about the marker type: "M" for marker, "D" for delta marker, including the marker number ("M1" to "M6" and "D2" to "D6").

The vertical position of the marker is represented by a small horizontal line on the trace itself.



Figure 14-18: Indicator of vertical marker position

The marker coordinates are also shown in numerical form in the marker list above the diagram area. The marker list opens when you activate the first marker.

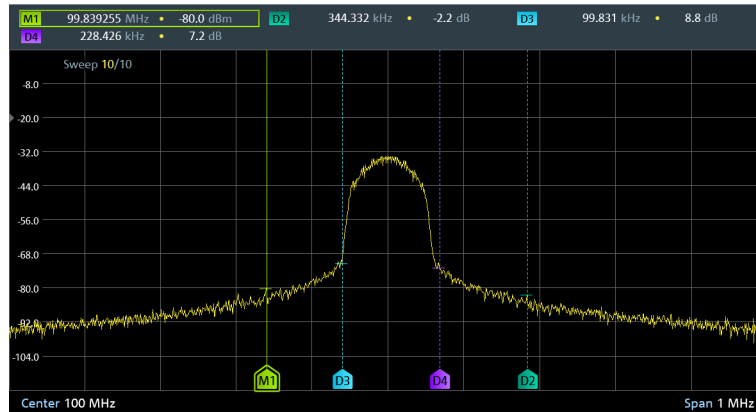

Figure 14-19: Marker information in the diagram area and the marker list above the diagram

The marker list contains the following information.

- Marker number and type.
 "M" for normal markers, "D" for delta marker, including the marker number ("M1" to "M6" and "D2" to "D6").
 The currently selected marker is framed by a colored line.
 - Horizontal position of the marker.
 The horizontal position is usually a frequency value. [Zero span](#) measurements show the time on the x-axis. Normal markers indicate absolute values, delta marker the (relative) distance to the first marker (reference marker).
 In [Figure 14-19](#), for example, the frequency for the first marker ("M1") is an absolute value, while the frequency of the second marker, a delta marker, is displayed as an offset to the first marker. Because the second marker is located to the left of the first marker, it is a negative value.
 - Vertical position of the marker.
 The vertical position is usually the measured level. Normal markers show the measured level as an absolute level in dBm. Delta markers indicate the level relative to the first marker.
 In [Figure 14-19](#), for example, the level measured at delta marker 2 ("D2") is a few dB less than the level measured for marker 1 ("M1").
- [Marker Positioning](#)..... 120
 - [Automatic Marker Positioning](#)..... 123
 - [Marker Search Ranges](#)..... 124

14.9.1 Marker Positioning

You can position the markers on any trace point you like. The R&S FPC also provides some useful tools to position markers [automatically](#).

Positioning a marker

1. Press the "Mkr" key to open the marker menu.

If, as yet, no marker is active, the R&S FPC automatically activates a normal marker ("M1") and positions it on the highest level that has been measured. In addition, the "Marker" input field opens.

The "Marker" input field allows you to define the position of the marker on the x-axis.

2. You can change the marker position in several ways.
 - Move the marker with the cursor keys.
Use the "Up" and "Down" cursor keys to move the marker to the left or right of its current position. The step size (the distance the marker moves) is 10 % of the span.
 - Move the marker with the rotary knob.
Use the rotary knob to move the marker to the left or right of its current position. The step size (the distance the marker moves) is one pixel.
 - Enter a marker position with the number keys.
Enter a specific frequency or time to move the marker to that position (for example 100 MHz if you want to know the level measured at that frequency).
 - Position the marker [automatically](#).

You can turn off the marker at any time by selecting the "Marker 1" menu item.

Adding additional markers

1. Press the "Mkr" key to open the marker menu.
At the same time, the R&S FPC activates the first marker ("M1").
2. Select the "Marker <x>" menu item (not "Marker 1" because that would deactivate the first marker).

The R&S FPC adds a second marker to the diagram.

When a normal marker is already active, each marker that you add will automatically be a delta marker.

Add as many delta markers as you like in that way.

You can move delta marker in the same way as normal marker. Note, however, that if you define a delta marker position with the number keys, the value you enter is a value relative to the first marker. Positive values correspond to a position to the right of the reference marker, negative values to a position to the left of the reference marker.

3. If more than one marker is active, you have to select the marker you want to move first.
Selected markers have a highlighted softkey and a line surrounding the marker icon.
If the marker you want to move is not selected, you can select it by pressing the corresponding softkey ("marker <x>").

Tip: You can turn on all six markers at the same time with the "All Markers On" menu item available in the marker menu. The R&S FPC positions the markers on the six highest signals in consecutive order.

Selecting the marker type

You can change the marker type for markers 2 to 6.

Because marker 1 is the reference marker for the delta markers, it is always a normal marker. Therefore, it cannot be converted to a delta marker.

1. Activate a marker and a delta marker.
2. Select the delta marker if it is not already selected.
3. Select the "Marker Type" menu item.

The delta marker turns into a normal marker. Its label changes accordingly (from "D<x>" to "M<x>") and its coordinates are now absolute values.

Removing markers or delta markers

You can remove markers or delta markers at any time you want.

1. Press the "Mkr" key to open the marker menu.
2. Select the marker or delta marker you want to remove with the corresponding "Marker <x>" softkey.

The R&S FPC selects the corresponding marker or delta marker.

3. Remove the marker or delta marker by selecting the corresponding menu item again.

The R&S FPC deletes the selected marker or delta marker.



Deactivating markers

If you delete marker 1 (M1), all delta markers that are relative to that marker are also deleted. Other markers remain.

Instead of removing individual selected markers, you can also remove all markers at the same time.

1. Press the "Mkr" key to open the marker menu.
2. Select the "All Marker Off" menu item.

The R&S FPC deletes all markers and delta markers.

Selecting the marker display type

You can position markers in terms of a frequency or in terms of a channel.

Defining the marker position in terms of a channel is possible when the measurement is based on a [channel table](#).

1. Press the "Mkr" key to open the marker menu.

2. Select the "Marker Display" menu item.
3. Select the input mode you prefer ("Frequency Display" or "Channel Display").
When you select the channel display, enter a channel number instead of a frequency to position the marker.

14.9.2 Automatic Marker Positioning

The R&S FPC has several useful tools to position markers automatically (for example on a peak level) and tools that change instrument settings based on the current marker position.

Selecting a marker

If you have more than one active marker, you have to select the marker you want to move first.

1. Press the "Mkr→" key to open the marker positioning menu.
2. Select the "Select Marker" menu item until the marker you want to move is selected.
You can see which marker is selected by the frame around the marker in the marker list and a frame around the marker icon in the diagram.

Positioning markers automatically

1. Press the "Mkr→" key to open the marker positioning menu.
Tip: Marker positioning functions are only available if at least one marker is active. If no marker or delta marker is active, they are not applicable.
2. Select the menu item of the positioning function you want to use.
 - "Set To Peak"
Positions the active marker or delta marker on the highest level value of the trace.
 - "Set To Next Peak"
Positions the active marker or delta marker on the next highest level value of the trace, relative to its current position.
 - "Set To Minimum"
Positions the active marker or delta marker on the lowest value of the trace.
 - "All Marker to Peak"
Places all existing markers or delta markers on the highest level values of the trace. This is done hierarchical whereas marker 1 is placed on the highest level, marker 2 is placed on the second highest level, and so on.
 - "Center = Marker Freq"
Matches the center frequency to the frequency of the selected marker or delta marker.
 - "Ref Level = Marker Level"
Matches the reference level to the level value of the selected marker or delta marker.

Keeping the marker on the peak

When you turn on a marker, it remains on the initial frequency by default. Marker tracking is a tool that allows you to keep track of a signal when its frequency changes.

1. Press the "Mkr→" key to open the marker positioning menu.
2. Select the "Marker Tracking" menu item to turn on marker tracking.

The marker remains on the peak level when its position in the spectrum changes. A chain symbol in the marker list indicates that marker tracking is active.



If you have defined a [search range](#), the marker tracks the signal only if it is within the search range.

14.9.3 Marker Search Ranges

When you position markers [automatically](#), the R&S FPC searches the complete current span for potential marker positions. Sometimes, it can be sufficient to search on a smaller frequency range. In that case, you can define a marker search range.

Defining marker search range

1. Press the "Mkr→" key to open the marker positioning menu.
2. Select the "Search Range" menu item to open the search range menu.
3. Select the "Search Range 1" menu item.
The R&S FPC opens a submenu to configure search range 1.
4. Select the "Lower Limit ..." menu item.
The R&S FPC opens an input field to set the lower limit of search range 1.
5. Enter the lower limit of the search range you want to use.
The R&S FPC draws a vertical line at the position you selected and labels it with 1 (for search range 1).
6. Select the "Upper Limit ..." menu item.
The R&S FPC opens an input field to set the upper limit of search range 1.
7. Enter the upper limit of the search range you want to use.
The R&S FPC draws another vertical line at the position you selected and labels it with 1 (for search range 1).

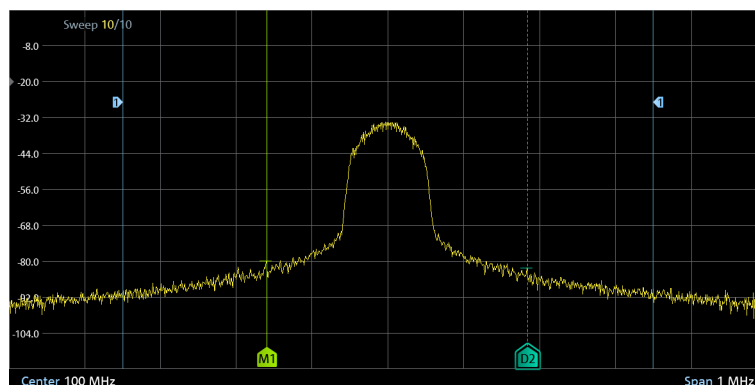

Figure 14-20: Marker search range lines

- To use search range 1 for measurements, select the "Set to Search Range 1" menu item.

The R&S FPC then uses the search range for the "Set To Peak", "Set To Next Peak", "Set To Minimum" and "All Marker To Peak" functions and positions the markers or delta markers inside this range.

Note: You can also define a second marker search range by selecting the "Search Range 2" menu item and repeating the other actions the same way.

Turning off marker search ranges

- Press the "Mkr→" key to open the marker positioning menu.
- Select the "Search Range Off" menu item.

The R&S FPC deactivates all search ranges and deletes the vertical lines of the search ranges.

14.10 Marker Functions

Access: "Mkr"

Remote commands required to control marker functions:

- [Chapter 19.12.8, "Marker"](#), on page 271

Marker functions are measurements that you can perform with markers. Depending on the marker function you have selected, the R&S FPC measures certain signal characteristics on the marker position.

The marker functions are applied to the currently selected marker.



Deactivating marker functions

Selecting a marker function again while it is still active turns that marker function off.

• Noise Measurement	126
• Frequency Counter	126
• Signal Bandwidth Measurement	127
• Marker Demodulation	128

14.10.1 Noise Measurement

Access: "Mkr" > "Marker Mode" > "Noise"

The marker noise measurement calculates the noise power density at the marker position in dBm/Hz. The R&S FPC includes several variables in the calculation of the noise power density, including the trace pixel values, the resolution bandwidth, the detector and the level display mode (absolute or relative). To stabilize the noise power display, the R&S FPC uses the pixel the marker is on and four pixels to the right and four pixels to the left of the marker pixel.

Noise power density can provide useful information when you are measuring noise or digitally modulated signals. However, you will get valid results only if the spectrum in the vicinity of the marker has a flat frequency response. When measuring the noise power density on discrete signals, results are not valid.

Note that the noise measurement only works for marker 1 (M1) or delta marker 2 (D2).

Measuring the noise density

1. Press the "Mkr" key to open the marker menu.
2. Select the "Marker Mode" menu item to open the marker function menu.
3. Select the "Noise" menu item.

The R&S FPC shows the noise density at the marker frequency in the marker list in dBm/Hz. If you are using a delta marker for the measurement, the results have the unit dBc/Hz with marker 1 being the reference. This is useful for phase noise measurements, for example.

4. Select the "Noise" menu item again to turn off the noise measurement.

14.10.2 Frequency Counter

Access: "Mkr" > "Marker Mode" > "Frequency Count"

The R&S FPC provides a frequency counter. The frequency counter accurately measures the frequency at the position of marker 1 (M1).

When calculating the horizontal position of the marker, the R&S FPC includes the current span, center frequency and the frequency of the pixel the marker is on. As the trace only has a limited number of pixels, the marker position is usually just an approximation, especially if the span is very large.

With the frequency counter, however, you can get a more accurate result of the frequency that the marker is positioned on. If the frequency counter is active, the

R&S FPC stops the measurement at the marker position for a short time and measures the frequency using the internal reference frequency.

The accuracy of the results therefore depends only on the accuracy of the internal reference frequency. The frequency counter has a resolution of 0.1 Hz and therefore provides far more accurate results. Despite the accuracy, the measurement is still fast (because of a special algorithm for the I/Q baseband signal).

The frequency counter only gives accurate results for sine signals that are at least 20 dB above the noise floor. If the S/N ratio is less, noise affects the results.

Measuring the frequency

1. Press the "Mkr" key to open the marker menu.
2. Select the "Marker Mode" menu item to open the marker function menu.
3. Select the "Frequency Count" menu item.
The R&S FPC displays the accurately measured frequency at the marker position in the marker list.
4. Select the "Frequency Count" menu item again to turn off the frequency counter.

14.10.3 Signal Bandwidth Measurement

Access: "Mkr" > "Marker Mode" > "N dB Down"

You can measure the signal bandwidth with the n dB down marker function.

The n dB down marker function uses the current value of marker 1 (M1) as the reference point. It activates two temporary markers on the signal, whose level is n dB below the level of the reference point. One temporary marker is placed to the left and the other to the right of the reference marker. The default setting for n is 3 dB, but it can be changed.

If you enter a positive offset, the two temporary markers are placed below the active reference point. If you enter a negative value (for example for notch filter measurements), the two temporary markers are placed above the active reference point.

Measuring the signal bandwidth

1. Press the "Mkr" key to open the marker menu.
2. Select the "Marker Mode" menu item to open the marker function menu.
3. Select the "N dB Down" menu item.
The R&S FPC shows two vertical lines in the diagram that represent the temporary markers and measures the distance (bandwidth) between those two lines.
4. Select the "N dB <x>" menu item to select the distance between the temporary markers.

Note: The distance to the reference marker is by default 3 dB below the reference marker.

14.10.4 Marker Demodulation

Access: "Mkr" > "Marker Demodulation"

The R&S FPC features an AM and FM demodulator to demodulate and monitor audio signals. It demodulates the signal at the marker frequency.

You can listen to the demodulated signal with the internal speaker or headphones that you can connect to the 3.5 mm headphone jack on the front of the R&S FPC.

When demodulating an AM modulated signal, the R&S FPC turns the video voltage into an audible sound. You should therefore set the reference level to about the level of the signal that you are demodulating.

If you perform measurements in the time domain, the R&S FPC demodulates continuously. In the frequency domain, you can define a time period the R&S FPC demodulates the signal at the marker frequency. The frequency sweep then stops at the marker frequency for that time before finishing the sweep.

Remote commands required to configure marker properties:

- [Chapter 19.12.8, "Marker"](#), on page 271

Selecting the demodulation type

1. Press the "Mkr" key to open the marker menu.
2. Select the "Marker Demodulation" menu item to open the marker demodulation menu.
3. Select the "AM" or the "FM" menu item

The R&S FPC demodulates the signal according to the demodulation scheme you have selected.

Note: If you turn on the demodulator, the R&S FPC automatically turns off the noise marker or the frequency counter.

4. Select the "Demodulation Off" menu item to turn off marker demodulation.

Defining the demodulation length

1. Press the "Mkr" key to open the marker menu.
2. Select the "Marker Demodulation" menu item to open the marker demodulation menu.
3. Select the "Time <x>" menu item.

The R&S FPC opens an input field to define the demodulation time.

4. Enter the demodulation time you want to use.

Note: The range is from 100 ms to 500 s. In the time domain, the R&S FPC demodulates continuously. The demodulation time has no effect in that case.

Defining the audio volume

1. Press the "Mkr" key to open the marker menu.
2. Select the "Marker Demodulation" menu item to open the marker demodulation menu.
3. Select the "Volume <x>" menu item.
The R&S FPC opens an input field to define the demodulation volume.
4. Enter the volume you are comfortable with.

Note: The demodulation volume is a percentage (0 % to 100 %) with 100 % being full volume.

For more information on general volume control, see [Chapter 9.6, "Audio Settings"](#), on page 43.

14.11 Display Lines

Access: "Lines"

Remote commands to configure display lines:

- [Chapter 19.12.10, "Display Lines"](#), on page 288

Like markers, display lines help you to determine the level of the signal.

A display line is a straight line that runs horizontally and corresponds to a certain level value. You can move the display line to each pixel in the display. This means that the accuracy and exact vertical position of the display line depends on the resolution of the vertical axis. With a display range of 100 dB, for example, each pixel corresponds to 0.3 dB. In that case, the accuracy of the display line is 0.3 dB. If you enter a value with a higher resolution, the R&S FPC rounds that value.

You can also move the display line with the rotary knob or the cursor keys. The step size for movement with the rotary knob is one pixel. The step size for the cursor keys is 10 % of the display range.

Using a display line

1. Press the "Lines" key to open the lines menu.
2. Select the "Display Line" menu item.
The R&S FPC displays the display line as a blue horizontal line. It shows the vertical position (usually a level value) of the line in a table above the diagram area. When you activate the display line, the R&S FPC also opens an input field to define the vertical position of the line.
3. Position the limit line by entering a level value into the input field.
Alternatively you can also move the display line with the rotary knob or the cursor keys.

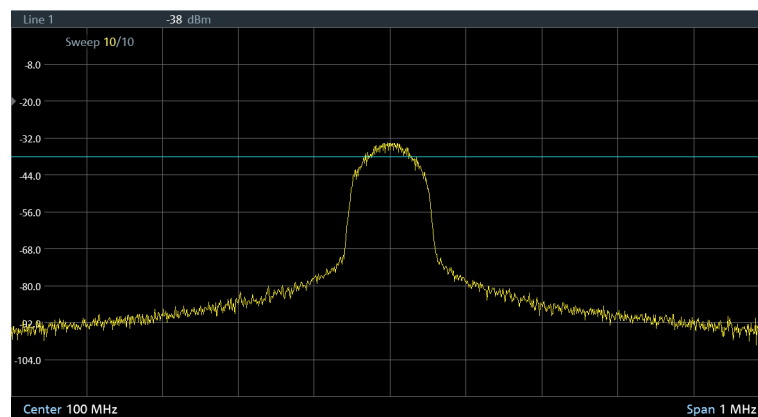

Figure 14-21: Display line at -38 dBm

14.12 Limit Lines

Access (limit lines menu): "Lines"

Limit lines are an analysis tool that allows you to compare the measured signal levels to signal specifications, and determine if the signal levels comply to the specifications.

Remote commands to configure limit lines:

- [Chapter 19.12.11, "Limit Lines"](#), on page 289

A limit line is made up out of two or more points that are connected to a line. Each of the points that define the shape of the limit line consists of two coordinates. One coordinate defines the horizontal position (for example the frequency), the other one the vertical position (usually a level value). You can make limit lines that consist of up to 1000 points.

Values that define the horizontal characteristics of the limit line can be either absolute values (for example the frequency in MHz) or relative values whose reference is the center of the measurement trace (for example the center frequency). Relative values are useful, for example, if you measure modulated output signals and change the center frequency, but need the limit line to remain the same. Absolute limit lines have the file extension `.abslim` while relative limit lines have the file extension `.rellim`.

Values that define the vertical characteristics are always level values in dB. If the scaling of the vertical axis is a linear one (units V or W), the R&S FPC automatically switches to a logarithmic scaling after you turn on the limit line.

When you turn on a limit line, the R&S FPC checks if the signal violates the shape of the limit line at one or more positions. If one or more signal levels exceed the limit value, the R&S FPC features several indicators that the limit check has failed.

- A general message in the diagram header that indicates if the signal violates the limit line, including the trace that violates the limit:
- An audio signal that sounds every time a limit is violated.

You can create and edit limit lines with the R&S InstrumentView software package and then transfer them into the internal memory of the R&S FPC. The number of limit lines you can store in the memory depends on other datasets available on the R&S FPC or, if you are using an external storage device (for example memory stick), the size of it.

Selecting a limit line

Before selecting a limit line, you need to decide if you want to use it as an upper or lower limit line.

Upper limit lines check if the signal is or remains below the limit line.

Lower limit lines check if the signal is or remains above the limit line.

You also have to make sure that the limit line is compatible to the scale of the x-axis.

1. Press the "Lines" key to open the lines menu.
2. Make sure that the "Show Limit Lines" menu item is active (highlighted).
3. Select the "Upper Limit" or the "Lower Limit" menu item.
4. Select the "Load From File" menu item to open the file manager.

The R&S FPC opens the directory that contains the limit lines by default (`\LimitLines\`). If you have stored limit lines in another directory, you have to navigate to that directory first.

By default, the R&S FPC shows all limit lines available in the selected directory (files with the `.abslim` or `.rellim` extension), even those that are not compatible to the current diagram scale.

5. Select the "Show Compatible" menu item to filter the available limit lines.

The R&S FPC shows only the limit lines that you can apply to the current diagram scale.

6. Select one of the available files and confirm the selection with the "Load" menu item.

The R&S FPC displays the limit line. In the diagram area, the limit line is represented by a red line whose shape depends on the limits.

If you have selected a limit line that is not compatible to the current diagram scale, the R&S FPC displays a message that it cannot apply the selected limit line.

Using a threshold line

A threshold line is a straight horizontal limit line whose limits are the same over the complete frequency range.

1. Press the "Lines" key to open the lines menu.
2. Make sure that the "Show Limit Lines" menu item is active (highlighted).
3. Select the "Upper Limit" or the "Lower Limit" menu item.
4. Select the "Set Threshold" menu item.

The R&S FPC opens an input field to define the limit line threshold.

5. Enter the required threshold.

The R&S FPC displays the threshold line. The threshold line is represented by a straight red line.

Hiding a limit line

Hiding a limit line allows you to switch quickly between showing and hiding a limit line and evaluate a limit check, without **turning it off** it completely.

When you hide a limit line, a limit check is no longer performed, but the limit line remains in the memory.

1. Press the "Lines" key to open the lines menu.
2. Select the "Show Limit Line" menu item.
 - "Show Limit Line" is highlighted: displays the limit line and evaluates the limit check.
 - "Show Limit Line" is not highlighted: hides the limit line and does not evaluate the limit check.

Removing limit lines

When you remove a limit line, it is no longer considered in the signal evaluation. You have to deliberately **select** it again if you want to use the limit line again.

1. Press the "Lines" key to open the lines menu.
2. Select the "Upper Limit" or the "Lower Limit" menu item.
3. Select the "Remove" menu item.

Performing limit checks

If limit lines are active, the R&S FPC automatically checks the trace for limit violations after each frequency sweep. As long as the signal does not violate the limit line, the R&S FPC shows a "Pass" message in the measurement diagram. As soon as one single value (= one pixel) is outside of the limits, the R&S FPC displays a "Fail" message in the diagram area.

A limit check relates only to the frequency range defined by the limit line, not the span.



Limit violation

Note that a limit check fails only if the signal exceeds the limit line.

If the signal level is the same as the limit value, the limit check passes.

You can also turn on an audio signal that sounds an alarm if a limit check fails.

1. Press the "Lines" key to open the lines menu.
2. Select the "Audio Beep" menu item.

The "Audio Beep" menu item.

If the audio beep is active, the R&S FPC beeps each time a limit is violated.

The audio signal is active when the "Audio Beep" menu item is highlighted.

15 The Receiver Application

Available with the optional "Receiver" application.

The receiver application measures the power level of a specific frequency or a customized set of frequencies instead of sweeping over (parts of) the frequency spectrum. The R&S FPC shows the results in result displays that have been designed for just such measurement tasks.

The receiver mode also adds the necessary functions like bandwidths or detectors to perform measurements according to CISPR.

Selecting the receiver application

1. Press the "Mode" key to open the mode menu.
2. Select the "Receiver" menu item.

• Measurements and Result Displays	134
• Frequency Configuration	138
• Amplitude Configuration	142
• Bandwidth Configuration	143
• Sweep Configuration	144
• Trace Configuration	144
• Limit Lines	145
• Marker Configuration	145

15.1 Measurements and Result Displays

Access: "Meas"

Remote commands required to configure measurements:

- [Chapter 19.13.1, "Measurement Configuration"](#), on page 295

In receiver mode, the R&S FPC supports two measurement modes.

- Fixed frequency measurements
- Frequency scans

Fixed measurement mode is designed for measurements on single frequencies. Scan measurement mode performs scans on a defined set of frequencies.

• Bargraph Measurement	134
• Frequency Scan	136
• Max Hold Information	138

15.1.1 Bargraph Measurement

Access: "Meas" > "Bargraph"

The bargraph measurement measures the signal level of a **single frequency** and shows the results in a bargraph.

The bargraph result display is a basic result display that shows the signal level at a specific frequency. The signal level is shown both as a numeric value and graphically as a bargraph.

The results in the bargraph are shown as soon as you enter the receiver application (for the frequency that is currently selected). The results are updated continuously. The current signal level is represented by light blue vertical lines in the bargraph. The unit of the displayed power level is variable and depends on the unit you have set.

The scale of the bargraph depends on the current reference level and display range.

In addition to the current signal level, the bargraph also shows the highest signal level that has been measured since the measurement has begun (**Max Hold** information). It remains effective, even if you change any receiver settings (for example the frequency or the attenuation) and is only reset when you deliberately do so.

The max hold information is represented by a dark blue vertical line in the bargraph. The max hold information is also displayed in a dark blue font above the bargraph.

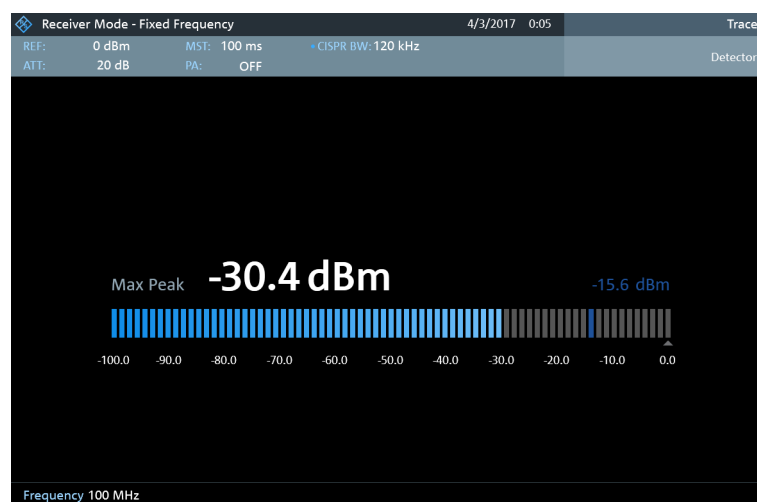

Figure 15-1: Diagram for the bargraph measurement, including maxhold information

Selecting bargraph measurements

1. Press the "Meas" key to open the measurement menu.
2. Select the "Bargraph" menu item.

The R&S FPC shows the signal level measured at the current receiver frequency.

Displaying a second bargraph

You can display a second bargraph with a different configuration (the detector, for example).

1. Press the "Meas" key to open the measurement menu.
2. Select the "Show Bargraph 2" menu item.

3. Press the "Trace" key to open the trace menu.
4. Select the "Trace <x>" menu item to select one of bargraphs.
5. Configure both bargraphs as you like.

15.1.2 Frequency Scan

Access: "Meas" > "Frequency Scan"

Access (trace style): "Trace" > "Trace Style: <x>"

Compared to bargraph measurements, frequency scans measure a certain set of receiver frequencies. The scan measures only those frequencies that are defined in the [frequency range](#). The space between the receiver frequencies is not considered in the measurement.

The R&S FPC shows the results for a frequency scan in a graphical result display. The horizontal axis in that display represents the frequency spectrum covered by the scan. The vertical axis represents the signal level.

The signal levels for each frequency measured during the scan are represented by a vertical line at the receiver frequencies that have been measured. This type of display emphasizes the fact that the scan measures single receiver frequencies only and not the frequencies between those receiver frequencies.

Yellow lines (or green lines if you display a second trace) indicate the current signal level. Blue lines indicate the highest level that has been measured since the measurement was started ([Max Hold](#) information).

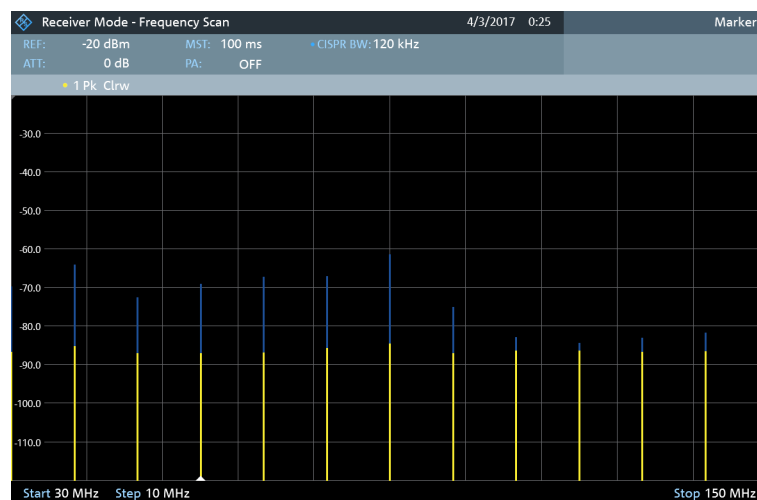

Figure 15-2: Fixed frequency scan in the range from 30 MHz to 150 MHz with a stepsize of 10 MHz

Selecting frequency scans

1. Press the "Meas" key to open the measurement menu.
2. Select the "Frequency Scan" menu item.

The R&S FPC shows the scan diagram. For each measured frequency, it shows a vertical bar.

Displaying a second trace

You can display a second trace with a different configuration (trace mode or detector, for example).

1. Press the "Meas" key to open the measurement menu.
2. Select the "Show Trace 2" menu item.
3. Press the "Trace" key to open the trace menu.
4. Select the "Trace <x>" menu item to select one of traces.
5. Configure both traces as you like.

Selecting the trace style

The trace style defines the way the trace looks.

1. Press the "Trace" key to open the trace menu.
2. Select the trace style.
 - "Trace Style: Lines": Shows a vertical line for each receive frequency as described above.
 - "Trace Style: Polygons": Shows the trace as a continuous, horizontal line. The gaps between the measurement frequencies are interpolated.

Displaying the peak list

As an alternative to evaluating the scan results in a diagram, you can display them in a table.

1. Press the "Meas" key to open the measurement menu.
2. Select the "View Peak List" menu item.

The R&S FPC shows the peak list.

The table header shows the trace number and the detector applied to the corresponding trace.

Each row in the table represents a [measurement point](#). If the scan evaluates more than 15 frequencies, the table only shows the highest levels.

For each frequency, the peak list shows the following information.

- **Peak**
Index number between 1 and 15.
- **Frequency**
Frequency at which the peak was measured.
- **Level**
Level of the peak.
- **Delta Limit**

Distance to the limit line, if a limit line is active.

If a [second trace](#) is active, the peak list shows the highest peaks of both traces.

15.1.3 Max Hold Information

Access: "Meas"

Both the bargraph measurement and the frequency scan contain max hold information. Max hold information indicates the highest level that has been measured since you have started the measurement.

In the bargraph measurement, the R&S FPC displays the highest level that was measured, regardless of the selected frequency. If, for example, you first measure a signal level of 110 dB μ V at 100 MHz, then change the frequency and measure a signal level of 100 dB μ V at the new frequency, the highest measured level will still be 100 dB μ V.

In the frequency scan, the R&S FPC displays the highest level for all frequencies that are part of the frequency range. The max hold information is indicated by a blue line that is appended to the yellow line (which indicate the current signal level).

The max hold information is displayed for both frequency modes (frequency display and channel display).

Resetting the max hold

To begin a new max hold measurement, you have to reset the max hold information deliberately.

1. Press the "Meas" key to open the measurement menu.
2. Select the "Refresh Max Hold" menu item.

15.2 Frequency Configuration

Access: "Freq"

Access: "Setup" > "Config Overview" > "Frequency" (selected settings)

Remote commands to configure the frequency:

- [Chapter 19.13.2, "Frequency"](#), on page 296

The frequency configuration in the receiver application depends on the [measurement](#) you have selected.

In case of a fixed frequency scan, you define a single receiver frequency that is analyzed.

In case of a frequency scan, you define a frequency range and a stepsize. The combination of both defines the frequencies that are measured during the scan.

- [Frequency Configuration \(Bargraph\)](#)..... 139
- [Frequency Configuration \(Frequency Scan\)](#)..... 140

15.2.1 Frequency Configuration (Bargraph)

In bargraph measurement mode, the R&S FPC determines the power level of a single frequency only. You can measure any frequency supported by the R&S FPC.

Defining the receiver frequency

1. Press the "Freq" key to open the frequency menu.
2. Select the "Frequency" menu item.

The R&S FPC opens an input field to define the receiver frequency.

3. Enter the receiver frequency you want.

The frequency you have entered becomes the new receiver frequency. The R&S FPC updates the bargraph accordingly.

You can also define the frequency by selecting a specific transmission channel. In that case, the frequency is defined in a [channel table](#).

Defining a frequency step size

For a quick change of frequencies with the rotary knob, define a frequency step size.

1. Press the "Freq" key to open the frequency menu.
2. Select the "Frequency Step" menu item to open the frequency step menu.
3. Select one of step size options.

- "0.1 x RBW"

The step size equals 10 % of the resolution bandwidth.

- "= Center"

The step size equals the center frequency.

- "Manual <x> Hz"

Define any step size you want in the input field that opens when you select this option.

The R&S FPC adjusts the step size accordingly.

Using channel tables

For measurements on systems that use channels instead of single frequencies, you can also load a [channel table](#) and measure the channel power.

1. Press the "Freq" key to open the frequency menu.
2. Select the "Frequency Mode" menu item.
3. Select the "Channel Downlink" or "Channel Uplink" menu item to select a channel table.

Note that when you work with channel tables, you select the frequency in terms of a channel. The channel defines the receiver frequency.

15.2.2 Frequency Configuration (Frequency Scan)

In frequency scan measurement mode, the R&S FPC determines the power levels of a set of single frequencies.

The scan range defines the frequency range that the scan takes place in. Therefore, you have to define a start and stop frequency for the scan range and a scan step size. The step size defines the (equidistant) space between the receive frequencies and thus, in combination with the start and stop frequency, the number of receive frequencies considered in the scan. Each receive frequency represents a measurement point.

Example:

If you define a scan range from 100 MHz to 200 MHz with a step size of 10 MHz, the receive frequencies that are analyzed are 100 MHz, 110 MHz, 120 MHz, ..., 200 MHz. Overall, this scan range defines a set of 11 receiver frequencies.

Defining a scan range

1. Press the "Freq" key to open the frequency menu.
2. Select the "Start Frequency" menu item.
The R&S FPC opens an input field to define the start frequency of the scan range.
3. Enter the frequency you want the scan to start at.
4. Select the "Stop Frequency"
The R&S FPC opens an input field to define the stop frequency of the scan range.
5. Enter the frequency you want the scan to stop at.
6. Select the "Scan Step" menu item.
The R&S FPC opens an input field to define the frequency step size of the scan.
7. Enter the step size you want to apply.
8. Select the "Full Scan" menu item to scan the full frequency range of the R&S FPC.

Performing a channel scan

Instead of a frequency scan, you can also perform a channel scan. A channel scan is based on the contents of a channel table. In case of measurements based on a [channel table](#), the set of receiver frequencies (or channels) is defined in a channel table.

In a channel table, you can define the receiver frequencies as you wish. The number of receiver frequencies depends on the number of channels included in the channel table and there may even be gaps between the receiver frequencies.

1. Press the "Freq" key to open the frequency menu.
2. Select the "Frequency Mode" menu item.
3. Select the "Channel Downlink" or "Channel Uplink" menu item to select a channel table.

Selecting the scale of the x-axis

You can display the x-axis in a linear or a logarithmic scale.

In a linear display, the frequencies are distributed linearly across the x-axis. That means the entire frequency range is divided by the number of measurement points, and the distance between measurement points is equal. Linear scaling is useful to determine precise frequencies within a small range.

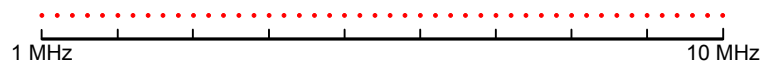

Figure 15-3: Linear x-axis scaling: the distance between the measurement points is equal, e.g. 200 kHz

However, if high and low frequencies appear in the same display, it is difficult to determine individual frequencies precisely or to distinguish frequencies that are close together.

In a logarithmic display, lower frequencies are distributed among a much larger area of the display, while high frequencies are condensed to a smaller area. Now it is much easier to distinguish several lower frequencies, as they are spread over a wider area. Logarithmic scaling is useful for overview measurements when a large frequency range must be displayed in one diagram.

However, with logarithmic scaling, the frequency resolution between two measurement points deteriorates with higher frequencies.

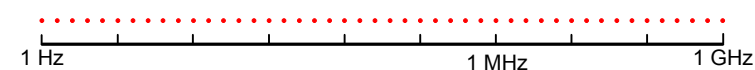
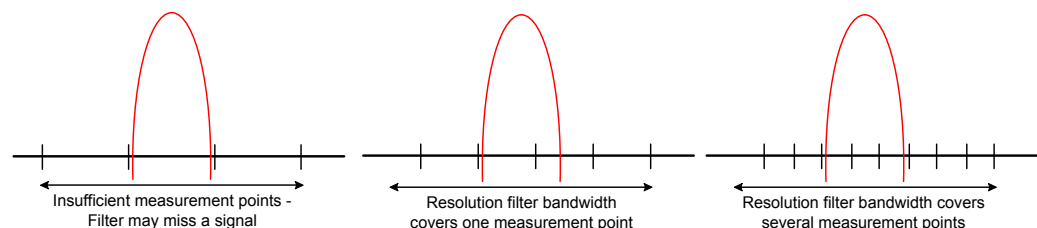

Figure 15-4: Logarithmic x-axis scaling: the distance between measurement points is variable

In the spectrum from 10 Hz to 100 Hz, the distance is a few Hz. Between 100 MHz and 1 GHz, the distance is several MHz.

Thus, for logarithmic x-axis scaling, the number of measurement points must be sufficiently high in order to distinguish high frequencies precisely. The resolution bandwidth should cover at least one measurement point (that means: the distance between two measurement points should not exceed the RBW). If this condition is not met, signals or interferers could be missed, especially narrowband interferers.



1. Press the "Freq" key to open the frequency menu.
2. Select either the "Linear Scale" or "Log Scale" menu items.

The R&S FPC changes the scale of the x-axis accordingly.

15.3 Amplitude Configuration

Access: "Ampt"

Access: "Setup" > "Config Overview" > "Amplitude" (selected settings)

Access: "Setup" > "Config Overview" > "Input" (selected settings)

Remote commands to configure the amplitude:

- [Chapter 19.13.3, "Amplitude"](#), on page 299

The following amplitude settings available in the receiver application are the same as in the spectrum application.

- "Reference Level": [Chapter 14.4.1, "Reference Level"](#), on page 99
- "Range / Ref Position" > "Auto Range": [Chapter 14.4.3, "Scale of the Y-Axis"](#), on page 103
- "Range / Ref Position" > "Range <x> dB": [Chapter 14.4.3, "Scale of the Y-Axis"](#), on page 103
- "Range / Ref Position" > "Linear 0 - 100%": [Chapter 14.4.3, "Scale of the Y-Axis"](#), on page 103
- "Range / Ref Position" > "Ref Position": ["Defining the position of the reference level"](#) on page 100
- "Range / Ref Position" > "Reference Offset": ["Defining a reference offset"](#) on page 100
- "Unit": ["Selecting the display unit"](#) on page 103
- "Preamplifier": ["Preamplifier"](#) on page 103
- "Attenuator": ["RF attenuator"](#) on page 101
- "Impedance": ["Selecting the input impedance"](#) on page 98
- "Transducer": [Chapter 14.4.4, "Transducers"](#), on page 104

Defining the bargraph scale

The scale of the bargraph depends on the [reference level](#) and the level range.

The reference level is the maximum power level that the bargraph displays. You should set the reference level in a way that the signal level does not exceed the reference level. It should also be high enough so that the signal does not disappear in the inherent noise.

1. Press the "Ampt" key to open the amplitude menu.
2. Select the "Reference Level" menu item.
3. Define the reference level that best fits the measurement.
If you measure unknown signals, define a high reference level in combination with a high attenuation to avoid an input overload.
In the default state, the reference level corresponds to the level at the right of the bargraph. A triangle in the bargraph scale indicates the position of the reference level.
If necessary, you can move the reference position to another position on the scale.

4. Select the "Range / Ref Position" menu item to open the corresponding menu.
5. Select the "Ref Position <x>" menu item.
6. Move the position of the reference level on the bargraph scale to another position. The range is from 0 to 10. "0" corresponds to the left side of the bargraph, "10" corresponds to right side of the bargraph.
You can also select the level range that the bargraph covers. In the default state, the bargraph covers 100 values of the unit you have selected (e.g. 100 dBµV).
7. Select the "Range <x>" menu item.
8. Define the level range you need.
Tip: Auto range. When you select the "Auto Range" menu item, the R&S FPC automatically adjusts the range of the bargraph based on the currently applied signal strength.

15.4 Bandwidth Configuration

Access: "BW"

Access: "Setup" > "Config Overview" > "Bandwidth" (selected settings)

Remote commands to configure the bandwidth:

- [Chapter 19.13.4, "Bandwidth"](#), on page 299

The receiver application adds 6 dB resolution bandwidths to the 3 dB [resolution bandwidths](#) already available in other applications. The 6 dB bandwidths are special bandwidths that are necessary for measurements according to CISPR16.

The R&S FPC provides an automatic bandwidth selection for CISPR bandwidths. When you select the bandwidth automatically, the R&S FPC selects an appropriate CISPR bandwidth, depending on the receiver frequency.

- Frequencies < 150 kHz: 200 Hz CISPR bandwidth
- Frequencies from 150 kHz to 30 MHz: 9 kHz CISPR bandwidth
- Frequencies from 30 MHz to 1 GHz: 120 kHz CISPR bandwidth
- Frequencies > 1 GHz: 1 MHz CISPR bandwidth

Selecting the bandwidth

1. Press the "BW" key to open the bandwidth menu.
2. Select one of the menu items.
 - "RBW: Manual": Selects a 3 dB bandwidth.
 - "CISPR BW: Manual": Selects a 6 dB bandwidth.
 - "CISPR BW: Auto": Automatically selects a 6 dB bandwidth, depending on the receiver frequency (see table above).

15.5 Sweep Configuration

Access: "Sweep"

Access: "Setup" > "Config Overview" > "Bandwidth" (selected settings)

Remote commands to control the measurement:

- [Chapter 19.13.5, "Sweep Control"](#), on page 300

The sweep menu provides settings to control the measurement and the way data is captured.

Defining the measurement time

The measurement time is the time that the R&S FPC collects data at each measurement frequency to calculate the results for that frequency according to the detector you have selected.

1. Press the "Sweep" key to open the sweep menu.
2. Select the "Measurement Time" menu item.
3. Define the measurement time you need.

Selecting the measurement mode

When you enter the receiver mode, the R&S FPC repeatedly measures the receive frequency or set of frequencies over the measurement time you have defined. If you want to measure a fixed frequency or frequency scan only once, select single scan mode.

1. Press the "Sweep" key to open the sweep menu.
2. Select the "Continuous Scan" menu item.

The R&S FPC starts a continuous measurement of the selected [receiver frequency](#) or [scan range](#).

You can interrupt a continuous measurement by selecting the "Continuous Sweep" menu item again.

3. Select the "Single Scan" menu item.

The R&S FPC starts a single measurement of the selected [receiver frequency](#) or [scan range](#).

15.6 Trace Configuration

Access: "Trace"

Access: "Setup" > "Config Overview" > "Analysis" (selected settings)

Remote commands to configure traces:

- [Chapter 19.13.6, "Traces"](#), on page 300

Trace settings in the receiver application described elsewhere:

- "Select Trace": [Chapter 14.8, "Trace Configuration"](#), on page 113
- "Trace Mode": [Chapter 14.8.1, "Trace Mode"](#), on page 115
(Note that the "Blank" and "View" trace modes are not available in the receiver.)
- "Detector": [Chapter 14.8.2, "Detector"](#), on page 116
The receiver application supports the "Max Peak", "Average" and "RMS" detector. In addition, the receiver application also has the "Quasi Peak" detector. The quasi-peak detector displays the maximum value weighted to CISPR 16-1-1 that was detected during the measurement.
- "Memory" / "Trace ▶ Memory": [Chapter 14.8.3, "Memory Traces"](#), on page 117
- "Trace Style": ["Selecting the trace style"](#) on page 137

15.7 Limit Lines

Access (limit lines menu): "Lines"

Remote commands to configure limit lines:

- [Chapter 19.12.11, "Limit Lines"](#), on page 289

For more information about limit lines, see [Chapter 14.12, "Limit Lines"](#), on page 130.

In the receiver application, limit lines must be compatible both to the [scale of the y-axis](#) and the [scale of the x-axis](#).

Limit line settings in the receiver application described elsewhere:

- "Show Limit Lines": ["Selecting a limit line"](#) on page 131
- "Upper Limit": ["Selecting a limit line"](#) on page 131
- "Lower Limit": ["Selecting a limit line"](#) on page 131
- "Audio Beep": ["Performing limit checks"](#) on page 132

Selecting a trace for the limit check

If you use two traces in the measurement, you can select which trace you want to check against the limits.

1. Press the "Lines" key to open the lines menu.
2. Select the "Select Trace <x>" menu item to select a trace.
The selected trace is highlighted blue.

15.8 Marker Configuration

Access: "Mkr"

Access: "Mkr →"

Remote commands to control marker:

- [Chapter 19.13.7, "Marker"](#), on page 302

Note that markers are only available for [frequency scans](#).

Marker settings in the receiver application described elsewhere:

- "Mkr" > "Marker <x>": [Chapter 14.9.1, "Marker Positioning"](#), on page 120
- "Mkr" > "Marker Type": ["Selecting the marker type"](#) on page 122
- "Mkr" > "Marker Demodulation": [Chapter 14.10.4, "Marker Demodulation"](#), on page 128
- "Mkr" > "All Markers Off": ["Removing markers or delta markers"](#) on page 122
- "Mkr→" > "Set to <x>": [Chapter 14.9.2, "Automatic Marker Positioning"](#), on page 123
- "Mkr→" > "Marker Tracking": [Chapter 14.9.2, "Automatic Marker Positioning"](#), on page 123
- "Mkr→" > "Search Ranges": [Chapter 14.9.3, "Marker Search Ranges"](#), on page 124

Synchronizing the bargraph frequency and marker position

You can synchronize the [receiver frequency of the bargraph](#) and the position of a marker in the frequency scan.

1. Press the "Meas" key to open the measurement menu.
2. Select and start a "Frequency Scan".
3. Press the "Mkr" key to open the marker menu.
4. Select a marker and position it on one of the measurement frequencies.
5. Select the "Marker To Fixed Freq" menu item.

The R&S FPC changes the receiver frequency to the marker frequency. At the same time, the R&S FPC turns on the fixed frequency measurement and measures the level of the new receiver frequency.

Selecting the marker display mode

For frequency scans based on a [channel table](#), you can select whether the marker information is displayed in terms of frequency or in terms of a channel number.

1. Press the "Mkr" key to open the marker menu.
2. Select ▼ and the "Marker Display" menu item.
3. Select the marker display mode you prefer.
 - "Frequency Display": Shows the marker position in terms of the channel frequency.
 - "Channel Display": Shows the marker position in terms of the channel number.

The selection has no effects on the displayed marker level.

16 Analog Demodulation

Available with the optional "AM, FM, ASK, FSK Demodulation" application.

The analog demodulation application demodulates amplitude modulated (AM) and frequency modulated (FM) signals, and shows various aspects of the modulated and demodulated signal. You can view the results as numerical values or as a line trace in a diagram to get an idea about the modulation accuracy of the signal.

Selecting the analog demodulation measurement application

1. Press the "Mode" key to open the mode menu.
2. Select the "Analog Demod" menu item.

• Measurements and Result Displays	147
• Frequency Configuration	150
• Amplitude Configuration	150
• Bandwidth Configuration	151
• Sweep Configuration	155
• Limits	156

16.1 Measurements and Result Displays

Access: "Meas"

Access: "Setup" > "Config Overview" > "Analysis" (selected settings)

Remote commands required to control measurements and result displays:

- [Chapter 19.14.1, "Measurements and Result Displays"](#), on page 303

The analog demodulation measurement application provides several measurements and numerical and graphical result displays. These result displays show various aspects and characteristics of the demodulated signal.

Selecting the measurement

The measurement type selects the modulation domain. The modulation domain defines the type of signal you want to demodulate (FM or AM signal). The signal processing is different, depending on the selected domain.

1. Press the "Meas" key to open the measurement menu.
2. Select the domain of the signal you want to demodulate.
 - "AM Domain": Demodulates amplitude modulated (AM) signals.
 - "FM Domain": Demodulates frequency modulated (FM) signals.

Make sure to apply a signal with the correct modulation domain. If you apply a signal with a different modulation than the selected domain, the results are not valid.

The demodulation starts directly after you have selected the measurement type. By default, the R&S FPC displays the results in a numerical result display, but you can also display the results in graphical result displays.

Selecting the result display

Both measurement types support a numerical and a graphical result display. Both result displays are based on the same measurement data (signal processing is also the same), but display the results in a different format.

1. Press the "Meas" key to open the measurement menu.
2. Select the domain of the signal you want to demodulate.
3. Select the result display.
 - "Mod. Trace": Shows the signal characteristics graphically in a diagram.



Figure 16-1: Trace display of an AM signal

The x-axis shows the demodulation characteristics of the signal over time. The y-axis shows the modulation depth in % (AM signals) or the frequency deviation in Hz (FM signals). The carrier frequency (center frequency) of the signal is indicated in the diagram footer.

The diagram header contains the most important signal characteristics in numerical form. These numerical values are also part of the numerical result summary. Note that the numbers may be in a red font - a red font indicates a violated limit if you have turned on a [limit check](#).

- "Mod. Summary": Shows the signal characteristics numerically in a table. For a detailed description of the individual values, see ["The numerical result summary"](#) on page 148.

The numerical result summary

The numerical result summary shows various aspects of the demodulated signal in numerical form.

AM Demod	Result	Upper Limit	Lower Limit	Status
Carrier Freq Offset	—	100.0 Hz	-9999999.9 Hz	—
Carrier Power	-45.5 dBm	50.0 dBm	-50.0 dBm	Pass
Modulation Index	51.5 %	100.0 %	0.0 %	Pass
+Peak	52.3 %	100.0 %	0.0 %	Pass
-Peak	-51.3 %	0.0 %	-100.0 %	Pass
±Peak/2	51.8 %	50.0 %	0.0 %	Fail
RMS	36.1 %	50.0 %	0.0 %	Pass
Modulation Freq	1.302 kHz	1.000 kHz	0.000 kHz	Fail
SINAD	37.5 dB	100.0 dB	-20.0 dB	Pass
THD	-45.9 dB	20.0 dB	-100.0 dB	Pass

Center 100 MHz

Figure 16-2: Numerical results for an AM signal, including limit evaluation

For each aspect, the R&S FPC shows the measured "Result", and, if you are using [limits](#), the "Upper Limit" and "Lower Limit" value you have defined, including the "Status" of the limit check ("Pass" or "Fail").

The following results are evaluated:

- **Carrier Freq Offset**
Shows the deviation of the calculated carrier frequency to the ideal carrier frequency in Hz.
- **Carrier Power**
Shows the power of the carrier without modulation in dBm.
- **Freq Deviation (FM domain)**
Shows the frequency deviation that the carrier signal is modulated with.
- **Modulation Rate (FM domain)**
Shows the ratio of the frequency deviation and the reference deviation.
- **Modulation Depth (AM domain)**
- Shows the difference in amplitude the carrier signal is modulated with.
- **+Peak / -Peak**
Shows the minimum and maximum frequency deviation (FM signals) or modulation depth (AM signals).
- **±Peak/2**
Shows the average frequency deviation (FM signals) or modulation depth (AM signals).
 $(| +Peak | + | -Peak |) / 2$
- **RMS**
Shows the root mean square of the frequency deviation (FM signals) or modulation depth (AM signals).
- **Modulation Frequency**
Shows the modulation frequency.
- **SINAD**
Shows the signal-to-noise-and-distortion

The SINAD measures the ratio of the total power to the power of noise and harmonic distortions. The noise and harmonic power is calculated inside the AF spectrum span. The DC offset is removed before the calculation.

- **THD**

Shows the total harmonic distortion.

The THD is the ratio of the harmonics to the fundamental and harmonics. All harmonics inside AF spectrum are considered up to the tenth harmonic.

16.2 Frequency Configuration

Access: "Freq"

Access: "Setup" > "Config Overview" > "Frequency" (selected settings)

Remote commands to configure the frequency:

- [Chapter 19.14.2, "Frequency"](#), on page 308

The R&S FPC can demodulate a signal only if the frequency of the carrier signal is known. Therefore, you have to define the frequency of the carrier signal, before any useful information about the signal is shown in the application.

The width of the captured signal (the "span") is defined by the [demodulation bandwidth](#).

If you do not know the frequency of the carrier signal, you have to find it out. You can do that, for example, by searching the frequency spectrum in the spectrum application in the area where you assume that the carrier is located.

Frequency settings in the analog modulation application described elsewhere:

- "Center Frequency": ["Defining a center frequency"](#) on page 94
- "Frequency Step Size": ["Defining a frequency step size"](#) on page 94

16.3 Amplitude Configuration

Access: "Ampt"

Access: "Setup" > "Config Overview" > "Amplitude" (selected settings)

Remote commands to configure the amplitude:

- [Chapter 19.12.3, "Amplitude"](#), on page 252

Amplitude settings in the analog modulation application described elsewhere:

- "Reference Level": [Chapter 14.4.1, "Reference Level"](#), on page 99
- "Preamplifier": ["Preamplifier"](#) on page 103
- "Attenuator": ["RF attenuator"](#) on page 101
- "Impedance": ["Selecting the input impedance"](#) on page 98

When you select the graphical result display, you can also adjust the scale of the y-axis.

Adjusting the scale of the y-axis (AM signals)

The y-axis shows the results as a percentage that represents the modulation depth. The modulation depth indicates how much the modulated signal deviates from the unmodulated signal (0 %).

For AM signals, you can define the display range of the y-axis. The display range is defined by the deviation from the zero line per grid division.

1. Press the "Ampt" key to open the amplitude menu.
2. Select the "Deviation Per Division" menu item.
3. Enter a value between 0.1 % and 100 %. (If the value you enter is not supported, the R&S FPC round to the next supported value. If you enter 98 %, for example, the R&S FPC uses 100 %.

You can thus define a display range from ± 0.5 % to ± 500 %.

Adjusting the scale of the y-axis (FM signals)

The y-axis shows how much the modulated signal deviates from the unmodulated signal (0 Hz). The unit is Hz.

For FM signals, you can define the display range of the y-axis (manually and automatically). The display range is defined by the deviation from the zero line per grid division.

1. Press the "Ampt" key to open the amplitude menu.

Manual scaling of the y-axis:

2. Select the "Deviation Per Division" menu item.
3. Enter a value between 1 kHz and 1 MHz. (If the value you enter is not supported, the R&S FPC round to the next supported value. If you enter 412 kHz, for example, the R&S FPC uses 500 kHz.

You can thus define a display range from ± 5 kHz to ± 5 MHz.

Automatic scaling of the y-axis:

4. Select the "Scale Adjust" menu item.

The R&S FPC automatically scales the y-axis depending on the demodulated signal.

16.4 Bandwidth Configuration

Access: "BW"

Access (audio lowpass): "Meas" > "Audio Lowpass"

Access: "Setup" > "Config Overview" > "Bandwidth" (selected settings)

Remote commands to configure the bandwidth:

- [Chapter 19.14.4, "Bandwidth"](#), on page 309

Selecting the demodulation bandwidth

The demodulation bandwidth (DBW) determines the frequency range around the center frequency that is demodulated. It is not the 3 dB bandwidth of the filter but the useful bandwidth which is distortion-free regarding phase and amplitude.

Basically, the demodulation bandwidth should be as narrow as possible to improve the S/N ratio. The residual FM caused by noise floor and phase noise increases dramatically with the bandwidth, especially with FM.

For AM, the DBW should be $\geq 2 \times$ modulation frequency

For FM, the DBW should be $\geq 2 \times$ (frequency deviation + modulation frequency)

1. Press the "BW" key to open the bandwidth menu.
2. Select the "Manual DBW" menu item.
3. Enter the demodulation bandwidth you need.
If you enter a value that is not supported, the R&S FPC rounds to the next supported bandwidth.
Note that the selected bandwidth also defines the output sample rate and measurement time (see [Table 16-1](#)).

Selecting the audio lowpass filter

The audio lowpass filter is a decimating filter that improves the measurement of low modulation frequencies.

[Table 16-1](#) to [Table 16-6](#) contain information about the different audio frequency ranges as a function of the demodulation bandwidth and the audio filter.

In most cases, the audio filter with a "DBW/1" characteristic is sufficient. If you need to measure low modulation frequencies that are below the DBW/1 range, consider to select another audio filter that fits your requirements. When you are using the "DBW/10", "DBW/30" or "DBW/100" audio filter, both, the lower and the upper audio corner frequencies decrease by a factor of /10, /30, or /100, respectively.

1. Press the "Meas" key to open the measurement menu.
2. Select the "Audio Lowpass" menu item.
3. Select the filter you want to apply ("DBW/1", "DBW/10", "DBW/30" or "DBW/100").

Example:

Assume that the modulating frequency of an AM signal is 1 kHz.

For proper demodulation, the demodulation bandwidth must be at least 2 kHz (2 x modulation frequency).

As a 1 kHz DBW is not available, select the next higher one (10 kHz).

You can use the default "DBW/1" audio filter, because that filter supports a frequency range from 30 Hz to 5 kHz (see [Table 16-3](#)).

If you have to measure lower modulation frequencies, use a different audio filter. With the "DBW/10" filter, for example, the audio frequency measurement range is reduced by a factor of 10 to a range of 3 Hz up to 500 Hz (see [Table 16-4](#)).

Selecting the FM broadcast time

The FM broadcast time parameter selects the time constant of the deemphasis filter.

This deemphasis filter is commonly used in FM broadcasting to improve the S/N ratio. In that case, a modulated signal is extorted by a pre-emphasis filter before transmission, for example to eliminate frequencies that are more prone to interferences.

The deemphasis filter reverses the emphasis function after demodulation.

The deemphasis filter is available for 200 kHz and 300 kHz demodulation bandwidths.

1. Press the "BW" key to open the bandwidth menu.
2. Select the "FM Broadcast" menu item.
3. Select the time constant you need.
 - "Off": Applies no deemphasis filter.
 - "50 μ s": 50 μ s time constant (used, for example, in European FM broadcasting).
 - "75 μ s": 75 μ s time constant (used, for example, in North American FM broadcasting).

Defining the FM frequency deviation

The frequency deviation defines the difference between the modulated frequency and the center frequency.

1. Press the "BW" key to open the bandwidth menu.
2. Select the "Frequency Deviation" menu item.
3. Enter the frequency deviation of the signal you are measuring.

Table 16-1: Measurement times for the demodulation bandwidths

Demodulation bandwidth [Hz]	Measurement time [ms]
2000000	1
989000	3
650000	4
500000	6
300000	10
200000	16
100000	32
50000	65
30000	112
20000	163
10000	327

Table 16-2: Measurement time calculation for audio lowpass filters

Audio lowpass	Measurement time
DBW/1	x 1
DBW/10	x 10
DBW/30	x 30
DBW/100	x 100

Table 16-3: Minimum and maximum modulating frequencies for audio lowpass: DBW/1

Demodulation bandwidth	Modulating frequency [Hz]	
	Minimum	Maximum
2000000	6100	1000000
989000	3050	500000
650000	2350	325000
500000	1520	250000
300000	950	150000
200000	610	100000
100000	300	50000
50000	150	25000
30000	90	15000
20000	60	10000
10000	30	5000

Table 16-4: Minimum and maximum modulating frequencies for audio lowpass: DBW/10

Demodulation bandwidth	Modulating frequency [Hz]	
	Minimum	Maximum
2000000	610	100000
989000	305	50000
650000	230	32500
500000	150	25000
300000	95	15000
200000	60	10000
100000	30	5000
50000	15	2500
30000	10	1500
20000	6	1000
10000	3	500

Table 16-5: Minimum and maximum modulating frequencies for audio lowpass: DBW/30

Demodulation bandwidth	Modulating frequency [Hz]	
	Minimum	Maximum
2000000	185	30303
989000	90	15152
650000	70	9848
500000	45	7576
300000	30	4545
200000	20	3030
100000	10	1515
50000	5	758
30000	3	455
20000	3	303
10000	3	152

Table 16-6: Minimum and maximum modulating frequencies for audio lowpass: DBW/100

Demodulation bandwidth	Modulating frequency [Hz]	
	Minimum	Maximum
2000000	60	10000
989000	30	5000
650000	25	3250
500000	15	2500
300000	10	1500
200000	6	1000
100000	3	500
50000	3	250
30000	3	150
20000	3	100
10000	3	50

16.5 Sweep Configuration

Access: "Sweep"

Remote commands to control the measurement:

- [Chapter 19.14.5, "Sweep Control"](#), on page 311

The sweep menu provides settings to control the measurement and the way data is captured.

Selecting the measurement mode

The measurement mode defines how often the data is demodulated.

In continuous mode, the R&S FPC demodulates the signal over and over until you stop it deliberately. The measurement results are updated accordingly.

In single mode, the R&S FPC demodulates the signal once and then stops without updating the results any longer. Another measurement starts only when you deliberately initiate it.

1. Press the "Sweep" key to open the sweep menu.
2. Select the "Continuous Sweep" menu item.
The R&S FPC demodulates the signal continuously.
You can interrupt a continuous measurement by selecting the "Continuous Sweep" menu item again.
3. Select the "Single Sweep" menu item.
The R&S FPC demodulates the signal once and displays the results of that measurement.

16.6 Limits

Access (limits menu): "Lines"

Remote commands to configure limits:

- [Chapter 19.14.6, "Limits"](#), on page 312

Limits are an analysis tool that allows you to compare the measured signal levels to signal specifications, and determine if the measured signal characteristics comply to these specifications. You can define limits for all numerical results available in the AM and FM result summary.

Note that you can define limits only for the numerical results. The graphical results of the analog demodulation do not support limits or limit lines.

To use limits, you have to create a set of limit values with the "AM Limits" and "FM Limits" tools available with the R&S InstrumentView software. The functionality of these tools allows you to specify limits for each result type and whether the result should be checked against the limit or not.

For more information about creating, editing and transferring limits, refer to the user manual of the R&S InstrumentView.

Selecting and evaluating limits

1. Press the "Lines" key to open the limits menu.
2. Select the "Select Limits" menu item to open the file manager.

3. Navigate to the dataset that contains the limits you want to use.
Make sure to select a dataset that is compatible to the current measurement: limits for AM measurements have file extension `.amlim`, those for FM measurements have the file extension `.fmLim`.
You can use the "Show Compatible" menu item to display only those files that you can use for the current measurement mode.
4. Select one of the available files and confirm the selection with the "Load" menu item.
The R&S FPC shows the upper and lower limit values defined in the file in the corresponding columns of the result summary. It automatically checks if the results are within the limits or not. Results within the limits are indicated by a "Pass" message in a green font, results that violate the limits are indicated by a "Fail" message in a red font.

Removing limits

1. Press the "Lines" key to open the limits menu.
2. Select the "Clear Limits" menu item.
The R&S FPC removes the limit values from the result summary and no longer evaluates them.

Turning an audio signal in case of limit violation on and off

1. Press the "Lines" key to open the limits menu.
2. Select the "Audio Beep" menu item.
The R&S FPC plays an audio signal if any of the measured results fails the limit check.

17 Digital Demodulation

Available with the optional "AM, FM, ASK, FSK Demodulation" application.

The digital demodulation application demodulates signals modulated with amplitude-shift keying (ASK) and frequency-shift keying (FSK) modulation schemes. It analyzes these signals and shows various aspects of the modulated and demodulated signal. You can view the results in various result displays to get an idea about the modulation accuracy of the signal.

Selecting the digital demodulation measurement application

1. Press the "Mode" key to open the mode menu.
2. Select the "Digital Demod" menu item.

• Measurements and Result Displays	158
• Measurement Configuration	163
• Frequency Configuration	166
• Amplitude Configuration	167
• Sweep Configuration	168
• Trigger Configuration	169

17.1 Measurements and Result Displays

Access: "Meas"

Access: "Setup" > "Config Overview" > "Analysis" (selected settings)

Remote commands required to control measurements and result displays:

- [Chapter 19.15.1, "Measurements and Result Displays"](#), on page 313

The goal of digital demodulation is to determine the quality of the signal that is transmitted by the device under test (DUT) by comparing it against an ideal signal. The DUT is usually connected with the analyzer via a cable. The key task of the analyzer is to determine the ideal signal. Hence, the analyzer aims to reconstruct the ideal signal from the measured signal that is transmitted by the DUT. This ideal signal is commonly referred to as the reference signal, while the signal from the DUT is called the measurement signal.

After extracting the reference signal, the digital demodulation application compares the measurement signal and the reference signal, and the results of this comparison are displayed.

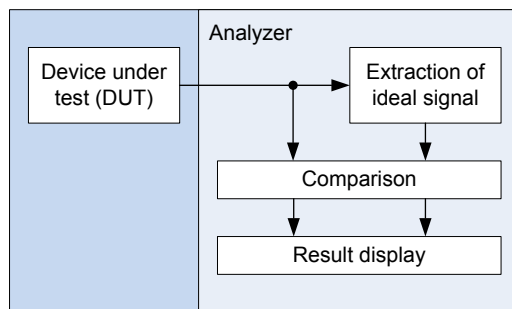

Figure 17-1: Demodulation principle

The R&S FPC provides several measurements and numerical and graphical result displays. These result displays show various aspects and characteristics of the demodulated signal.

Selecting the measurement

The measurement type selects the modulation scheme that the signal is modulated with. The signal processing is different, depending on the selected modulation.

1. Press the "Meas" key to open the measurement menu.
2. Select the modulation of the signal you want to measure.
 - "ASK": Demodulates 2ASK signals.
 Amplitude-shift keying (ASK) is a digital modulation scheme that changes the amplitude of the carrier to transmit different values (or symbols). Each value corresponds to a different amplitude. In the most basic form (2ASK), there are two (binary) values: 0 and 1. When a value of 1 occurs, the signal is transmitted with a certain, fixed amplitude. On a value of 0, the signal is transmitted with a reduced amplitude.
 Often the amplitude of the "1" signal is 100 % and the amplitude of the "0" signal is close to 0 % of the nominal carrier amplitude (OOK = on-off-keying). The R&S FPC detects the different amplitudes, demodulates the signal and retrieves the original sequences of the digital symbols.
 For proper demodulation, you have to match the [center frequency](#) to the ASK carrier frequency.
 - "FSK": Demodulates 2FSK signals.
 Frequency-shift keying (FSK) is a digital modulation scheme that changes the frequency of the carrier to transmit different values (or symbols). Each value corresponds to a different frequency. In the most basic form (2FSK), there are two (binary) values: 0 and 1. When a value of 0 occurs, the signal is transmitted with a certain frequency f_1 . On a value of 1, the signal is transmitted with a frequency f_2 .
 For proper demodulation, you have to set a [center frequency](#) that is the arithmetic mean of f_1 and f_2 .

Make sure to apply a signal with the correct modulation scheme. If you apply a signal with a different modulation than the selected one, the results are not valid.

The demodulation starts directly after you have selected the measurement. By default, the R&S FPC displays the results in a graphical result display, but you can also display the results in graphical result displays.

Selecting the result display

Both measurement types support several result displays. The information visualized in all result displays is based on the same measurement data (signal processing is also the same), but the type of information is different.

1. Press the "Meas" key to open the measurement menu.
2. Select the modulation scheme of the signal you want to demodulate (ASK or FSK).
3. Select the result display.
 - "Eye Diagram": Shows the modulation accuracy in that it analyzes the transitions from one modulation state to the other. An open "eye" indicates little distortion in the signal transmission. A closed "eye" indicates poor signal quality with a signal that is too long, too short, poorly synchronized, has too much noise, an over- or undershoot that is too high etc.

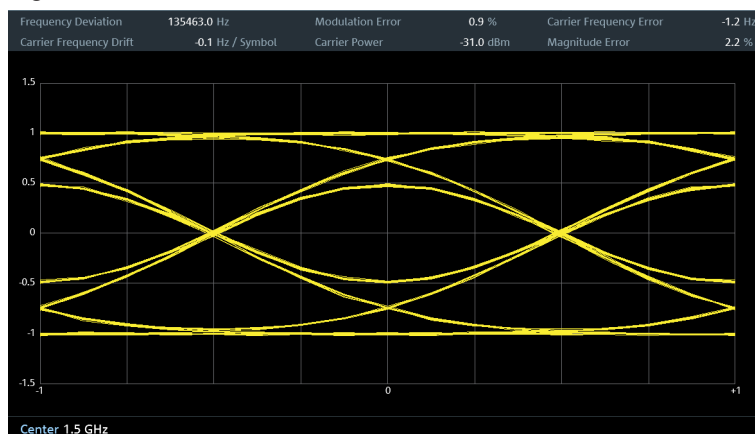

Figure 17-2: Eye diagram of a 2FSK signal

- "Symbols": Shows the stream of symbols or binary digits transmitted by the signal.

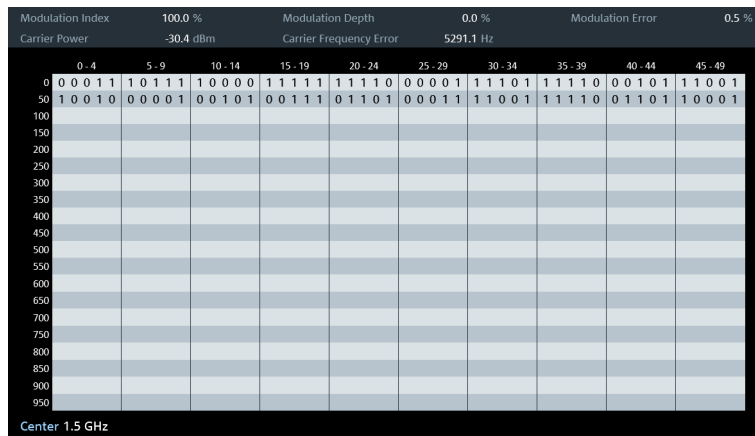

Figure 17-3: Symbol stream of a 2ASK signal

- "Modulation Depth" (ASK): Shows the modulation depth of the signal (see "Modulation depth and modulation index" on page 162 for more information).



Figure 17-4: Modulation depth of a 2ASK signal

- "Modulation Deviation" (FSK): Shows the frequency shift of the signal. The frequency shift (or frequency deviation) is the frequency difference between the mark (binary 1) and space (binary 0) frequencies representing the binary digits.

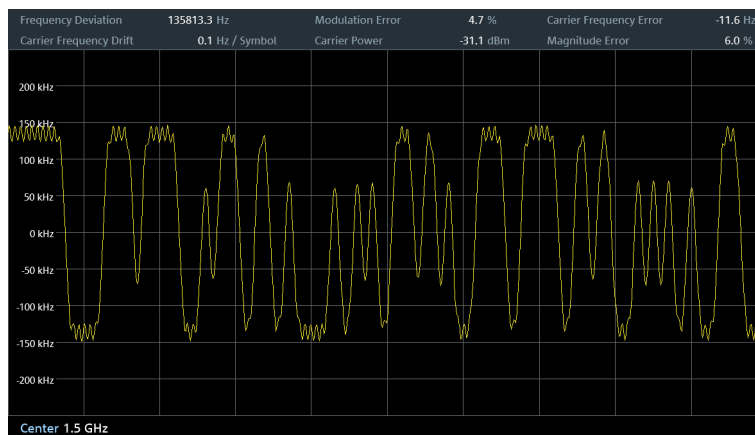

Figure 17-5: Modulation deviation of a 2FSK signal

- "Modulation Error": Shows the modulation error over time (% for ASK and Hz for FSK). The modulation error shows the deviation of the measured symbols from the ideal symbol locations. The ideal symbol locations are defined in a reference signal.

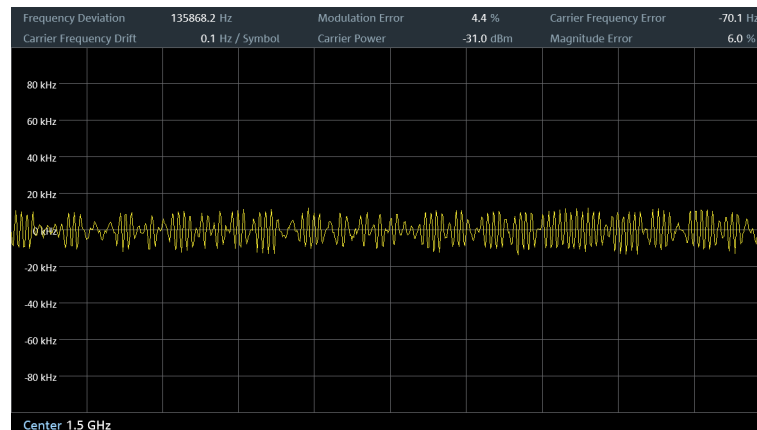

Figure 17-6: Modulation error of a 2FSK signal

Numerical results

The diagram header contains various numerical results of the modulated and unmodulated signals.

- **Frequency Deviation (FSK)**
Shows the frequency deviation between measured signal and reference signal.
- **Carrier Frequency Drift (FSK)**
Shows the drift in the carrier frequency of the measured signal.
- **Magnitude Error (FSK)**
Shows the difference between the measured magnitude and the magnitude of the reference signal.
- **Modulation Index (ASK)**
Shows the modulation index of the measured signal.
- **Modulation Depth (ASK)**
Shows the modulation depth of the measured signal.
- **Modulation Error**
Shows the modulation deviation between measured signal and reference signal.
- **Carrier Power**
Shows the power of the measured carrier signal.
- **Carrier Frequency Error**
Shows the mean carrier frequency offset in Hz.

Modulation depth and modulation index

The modulation depth indicates the amplitude drop during low state amplitudes (binary 1 = high state or modulated signal, binary 0 = low state or unmodulated signal). The high state amplitude is normalized to 100 % (top of the diagram by default). The modu-

lation depth is the amount that the amplitude drops during the low state in %. The modulation depth is therefore a value < 100 %.

Another way to express the amplitude variations of an ASK modulated signal is the modulation index. The expression comes from analog demodulation applications. The R&S FPC shows the modulation as a numeric result in the diagram header.

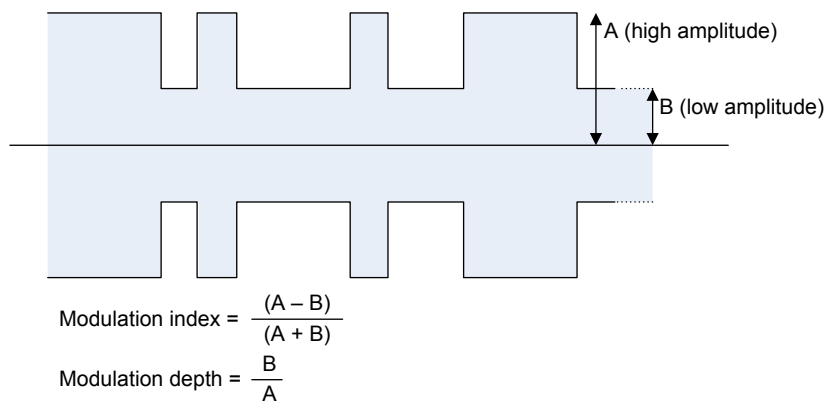

Figure 17-7: Calculation of modulation index and depth

17.2 Measurement Configuration

Access: "Meas" > "Demod Parameters"

Access: "Setup" > "Config Overview" > "Bandwidth" (selected settings)

Remote commands required to define demodulation parameters:

- [Chapter 19.15.2, "Measurement Configuration"](#), on page 318

A digital modulation system needs a transmit filter to limit the bandwidth of the transmitted signal. The receiver needs to know the characteristics of that filter to be able to demodulate the signal. Sometimes an additional receive filter is necessary for proper demodulation. You also have to define other demodulation parameters like the symbol rate or FSK deviation.

Other demodulation parameters like oversampling factor, reference filter or measurement filter, are automatically selected by the R&S FPC.

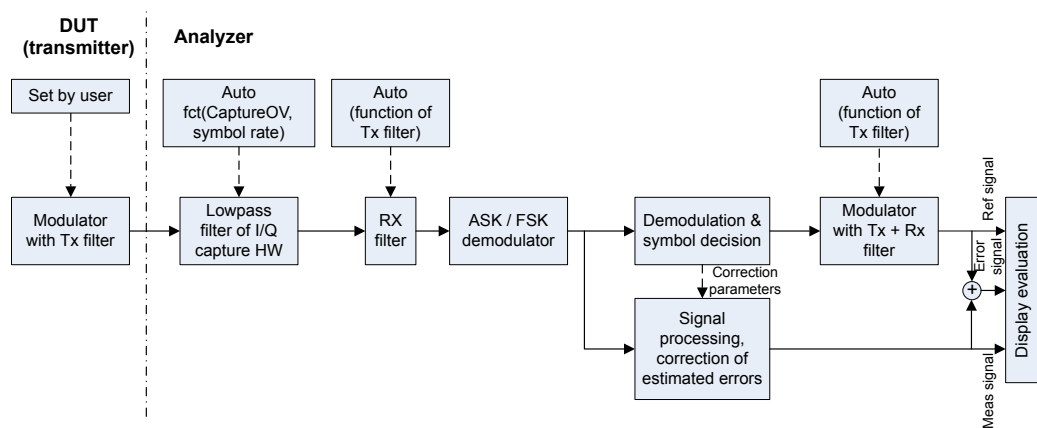

Figure 17-8: Block diagram of measurement filter

Selecting the filter type

The R&S FPC provides several filters that have to match the DUT transmit filter.

1. Press the "Meas" key to open the measurement menu.
2. Select the "Demod Parameters" menu item to open the demodulation menu.
3. Select the "Filter Type" menu item to open the filter type menu.
4. Select an appropriate filter for your signal. The filter type should be the same as that used by the transmitter; for example, if the transmitter uses a Gaussian filter, you should analyze the signal with a Gaussian filter, too. Otherwise, measurement results are not valid.

The R&S FPC provides the following filter types.

- "Root Raised Cosine" (RRC)
- "Raised Cosine"
- "Gaussian"
- "Unfiltered"

You can define the roll-off factor for all filters.

Defining the roll-off factor of the measurement filter

The roll-off factor defines the slope or bandwidth of the filter. Most radio transmissions use a roll-off factor of about 0.3 to 1.0. Increasing the roll-off factor increases the filter bandwidth.

For the raised cosine or RRC filter, the filter bandwidth is defined in terms the alpha value. For the Gaussian filter, the filter bandwidth is defined in terms of the BT value.

1. Press the "Meas" key to open the measurement menu.
2. Select the "Demod Parameters" menu item to open the demodulation menu.
3. Select the "Alpha/BT" menu item.
4. Enter the roll-off factor you want (a value between 0 and 1).

Defining the symbol rate

The symbol rate defines the number of symbols that are transmitted per time unit (expressed in Hz in the R&S FPC). Therefore, the symbol rate also indicates how many transitions from one state to another (0 to 0, 0 to 1, etc.) are done in that time unit.

1. Press the "Meas" key to open the measurement menu.
2. Select the "Demod Parameters" menu item to open the demodulation menu.
3. Select the "Symbol Rate" menu item.
4. Define the symbol rate of the signal you are measuring.

Defining the number of signal symbols

You can define the number of symbols that should be displayed at a time.

The R&S FPC always captures 4000 samples of raw data. This parameter only controls how many of those samples are demodulated and displayed.

The number of symbols you can define depends on the selected [filter type](#).

1. Press the "Meas" key to open the measurement menu.
2. Select the "Demod Parameters" menu item to open the demodulation menu.
3. Select the "Number of Symbols" menu item.
4. Increase or decrease the symbols you want to display as necessary.

Turning burst processing on and off

Burst processing is a tool similar to a trigger that automatically detects the beginning and end of a burst in the capture buffer.

A burst is not detected:

- If the burst power is below a certain threshold.
- If the burst is too short.
- If the time between bursts is too short.

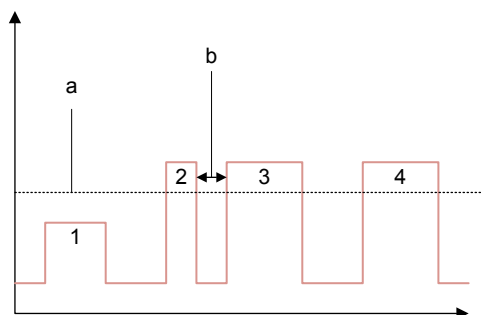

- a = Minimum required signal level
- b = Time between bursts
- 1 = No burst, because signal level increase is not enough
- 2 = No burst, because burst is too short
- 3 = No burst, because signal level increase occurs too soon after the last event
- 4 = Burst, because signal level is high enough, burst is long enough and time between bursts was large enough

When a burst was found, the R&S FPC tries to demodulate the signal based on the demodulation parameters you have set and displays the results.

1. Press the "Meas" key to open the measurement menu.
2. Select the "Demod Parameters" menu item to open the demodulation menu.
3. Select the "Burst Processing" menu item.

The R&S FPC looks for probable bursts in the capture buffer and demodulates the signal.

Selecting a standard

For FSK measurements, you can select one of several predefined standards.

Selecting one of those standards automatically configures various measurement parameters that comply to that standard: The [symbol rate](#), the [number of symbols](#) and the [filter characteristics](#) (filter type and roll-off factor).

Manual configuration of those parameters is thus not necessary.

1. Press the "Meas" key to open the measurement menu.
2. Select the "Standard" menu item to open the standards menu.
3. Select one of the following menu items.
 - "Bluetooth LE": For measurements on bluetooth low energy devices.
 - "Tire Pressure": For measurements on devices that check the tire pressure of cars.
 - "Off": For measurements on other signals.

17.3 Frequency Configuration

Access: "Freq"

Access: "Setup" > "Config Overview" > "Frequency" (selected settings)

Remote commands to configure the frequency:

- [Chapter 19.15.3, "Frequency"](#), on page 320

The R&S FPC can demodulate a signal only if the frequency of the carrier signal is known. Therefore, you have to define the frequency of the carrier signal, before any useful information about the signal is shown in the application.

If you do not know the frequency of the carrier signal, you have to find it out, for example by searching the frequency spectrum in the spectrum application in the area where you assume that the carrier is located.

Frequency settings in the digital modulation application described elsewhere:

- "Center Frequency": ["Defining a center frequency"](#) on page 94
- "Frequency Step Size": ["Defining a frequency step size"](#) on page 94
- "Frequency Offset": ["Defining a frequency offset"](#) on page 95

17.4 Amplitude Configuration

Access: "Ampt"

Access: "Setup" > "Config Overview" > "Amplitude" (selected settings)

Access: "Setup" > "Config Overview" > "Input" (selected settings)

Remote commands to configure the amplitude:

- [Chapter 19.15.4, "Amplitude"](#), on page 320

Amplitude settings in the digital modulation application described elsewhere:

- "Reference Level": [Chapter 14.4.1, "Reference Level"](#), on page 99
- "Preamplifier": ["Preamplifier"](#) on page 103
- "Attenuator": ["RF attenuator"](#) on page 101
- "Impedance": ["Selecting the input impedance"](#) on page 98

When you select one of the graphical result displays, you can also adjust the scale of the y-axis.

Defining the position of the reference (ASK signals)

In the graphical result displays, you can define the reference position on the y-axis.

The reference corresponds to the top of the grid (100 % by default). You can change the reference to another percentage, for example to see the signal in more detail.

1. Press the "Ampt" key to open the amplitude menu.
2. Select the "Ref Position" menu item.
The R&S FPC opens an input field to define the reference position.
3. Enter the percentage that should be displayed at the top of the diagram.
The R&S FPC adjusts the y-axis and the position of the trace accordingly.

Adjusting the scale of the y-axis

For both ASK and FSK measurements, you can adjust the display range of the y-axis.

The display range is defined in terms of values covered by a grid division. This value multiplied by 10 is the whole display range.

1. Press the "Ampt" key to open the amplitude menu.

2. Select the "Deviation Per Division" menu item.
3. Enter the deviation you like.
The R&S FPC adjusts the scale of the y-axis accordingly. Note that the trace is also compressed or enlarged accordingly.

17.5 Sweep Configuration

Access: "Sweep"

Remote commands to control the measurement:

- [Chapter 19.14.5, "Sweep Control"](#), on page 311

The sweep menu provides settings to control the measurement and the way data is captured.

Selecting the measurement mode

The measurement mode defines how often the data is demodulated.

In continuous mode, the R&S FPC demodulates the signal over and over until you stop it deliberately. The measurement results are updated accordingly.

In single mode, the R&S FPC demodulates the signal once and then stops without updating the results any longer. Another measurement starts only when you deliberately initiate it.

1. Press the "Sweep" key to open the sweep menu.
2. Select the "Continuous Sweep" menu item.
The R&S FPC demodulates the signal continuously.
You can interrupt a continuous measurement by selecting the "Continuous Sweep" menu item again.
3. Select the "Single Sweep" menu item.
The R&S FPC demodulates the signal once and displays the results of that measurement.

17.5.1 Function Reference

Continuous Measurement	168
Single Measurement	169

Continuous Measurement

See ["Selecting the measurement mode"](#) on page 168.

Remote command:

Measurement type: `INITiate:CONTinuous` on page 262

New measurement sequence: `INITiate[:IMMediate]` on page 263

Single Measurement

See ["Selecting the measurement mode"](#) on page 168.

Remote command:

Measurement type: `INITiate:CONTinuous` on page 262

New measurement sequence: `INITiate[:IMMediate]` on page 263

17.6 Trigger Configuration

Access: "Sweep" > "Trigger"

Remote commands to trigger measurements:

- [Chapter 19.15.6, "Trigger"](#), on page 322

Trigger settings in the digital demodulation described elsewhere:

- "Free Run": [Chapter 14.7, "Trigger Configuration"](#), on page 112
- "External Rise": [Chapter 14.7, "Trigger Configuration"](#), on page 112
- "External Fall": [Chapter 14.7, "Trigger Configuration"](#), on page 112

In addition to the trigger settings available in the spectrum application, the digital demodulation application provides an I/Q power trigger source.

Using the I/Q power trigger

The I/Q power trigger initiates a measurement when the magnitude of the sampled I/Q data exceeds a certain level.

1. Press the "Sweep" key to open the sweep menu.
2. Select the "Trigger" menu item to open the trigger menu.
3. Select the "IQ Power <x>" menu item.

The R&S FPC opens an input field to define the trigger level.

4. Define an appropriate trigger level.

To make sure that the trigger initiates a measurement, we recommend a trigger level that is about 6 dB lower than the actual expected signal level.

Note that a burst is only recognized if it is not too short and if the gap between two bursts is not too short.

18 Vector Network Analyzer

Available for the R&S FPC1500 with the optional VNA application.

The vector network analyzer (VNA) application provides the functionality to characterize networks with one or two ports. The VNA application allows you to determine the reflection or transmission characteristics of the device under test (DUT). In addition to the magnitude of the transmitted and reflected power, vector measurements also determine the phase characteristics of the DUT.

All measurements in the VNA application require a tracking generator that is available with the R&S FPC1500 (RF output). The tracking generator transmits a reference signal through the internal VSWR bridge to the test port. The reference signal (or stimulus signal) is the reference for the result calculation.

Selecting the VNA application

1. Press the "Mode" key to open the mode menu.
2. Select the "Vector Network Analyzer" menu item.

• Measurements and Result Displays	170
• Frequency Configuration	179
• Amplitude Configuration	181
• Bandwidth Configuration	182
• Sweep Configuration	183
• Trace Configuration	184
• Marker Configuration	184
• Limit Line Configuration	186

18.1 Measurements and Result Displays

Access: "Meas"

Remote commands to configure the bandwidth:

- [Chapter 19.16.1.1, "Measurements and Result Display"](#), on page 324

The VNA application provides several measurements for various purposes. For each measurement, you can also select one of several result formats that show the results from different perspectives.

• Transmission Measurement (S21)	171
• Reflection Measurement (S11)	171
• 1-Port Cable Loss Measurement	172
• Distance to Fault Measurement	173
• Measurement Formats	175
• DTF Configuration	177

18.1.1 Transmission Measurement (S21)

Access: "Meas" > "Transmission S21"

The transmission (S21) measurement measures how much of the stimulus signal passes through the DUT in forward direction (from port 1 to port 2). It is therefore an indicator of how much loss, or gain, is caused by the DUT. The resulting trace shows the ratio of the reflected power measured at the RF input to the stimulus signal over the frequency range you select.

For more information about the supported result formats, see [Chapter 18.1.5, "Measurement Formats"](#), on page 175.

For the transmission measurement, you must connect both DUT ports, input and output, to the R&S FPC, one to the RF output and one to the RF input. The signal source (RF output) provides the stimulus signal, the RF input measures the signal coming from the DUT.

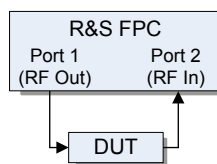

Figure 18-1: Setup of a transmission S21 measurement

Measuring the transmission

1. Connect the DUT to the R&S FPC as shown in [Figure 18-1](#).
2. Define the frequency parameters for the measurement.
For more information, see [Chapter 18.2, "Frequency Configuration"](#), on page 179.
3. Press the "Meas" key to enter the measurement menu.
4. Select the "Transmission S21" menu item to start the measurement.
5. Calibrate the transmission measurement.
For more information, see [Chapter 12, "Calibration"](#), on page 54.
6. After calibration, start the actual measurement (single sweep or continuous sweep).

18.1.2 Reflection Measurement (S11)

Access: "Meas" > "Reflection S11"

The reflection (S11) measurement measures the amount of RF power that is being reflected from the connected DUT port. The resulting trace shows the ratio of the reflected power to the stimulus signal over the frequency range you select. The displayed content depends on the [result format](#).

For the measurement, you have to connect the DUT port to the RF output of the R&S FPC. The other DUT port should be terminated during the measurement.

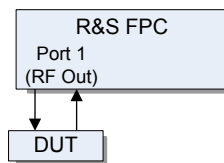

Figure 18-2: Setup of a reflection S11 measurement

If you measure the reflection on a system with two or more system components, the results are an aggregate over these components. Therefore you can only see the aggregated magnitude of the reflected power in the selected frequency range.

Measuring the reflection

1. Connect the DUT to the R&S FPC as shown in [Figure 18-2](#).
2. Define the frequency parameters for the measurement.
For more information, see [Chapter 18.2, "Frequency Configuration"](#), on page 179.
3. Press the "Meas" key to enter the measurement menu.
4. Select the "Reflection S11" menu item to start the measurement.
5. Calibrate the reflection measurement.
For more information, see [Chapter 12, "Calibration"](#), on page 54.
6. After calibration, start the actual measurement (single sweep or continuous sweep).

18.1.3 1-Port Cable Loss Measurement

Access: "Meas" > "1-Port Cable Loss"

The cable loss measurement is a reflection measurement on an open cable. It evaluates the amount of RF energy that a signal loses while traveling through a cable. The amount of lost energy depends on the frequency and the length of the cable.

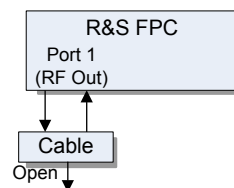

Figure 18-3: Setup of a 1-port cable loss measurement

By default, the R&S FPC evaluates the cable loss over its entire frequency range (full span of the R&S FPC). When you reduce the span, make sure to define a span that is appropriate for the measurement, especially for high center frequencies. Also make sure to consider the cable length and the wavelength of the selected center frequency. For a typical cable loss trace, select a span that is large enough to evaluate at least one peak and one minimum. Otherwise, the result might not be valid.

If the cable loss is constant over a large span (for example for low center frequencies), you can select any span.

Note that if the cable loss is greater than 20 dB, you are better off using the S21 measurement, because the cable loss measurement might yield invalid results.

Measuring the cable loss

1. Connect the DUT to the R&S FPC as shown in [Figure 18-2](#).
Make sure not to terminate the cable.
2. Define the frequency parameters for the measurement.
For more information, see [Chapter 18.2, "Frequency Configuration"](#), on page 179.
3. Press the "Meas" key to enter the measurement menu.
4. Select the "Reflection S11" menu item to start the measurement.
5. Calibrate the cable loss measurement.
For more information, see [Chapter 12, "Calibration"](#), on page 54.
6. After calibration, start the actual measurement (single sweep or continuous sweep).

18.1.4 Distance to Fault Measurement

Access: "Meas" > "Distance-To-Fault"

The distance to fault (DTF) measurement determines the exact location of possible faults in a transmission system. If you connect the end of the cable to the R&S FPC, the DTF measurement shows you the exact distance to the fault (in meter or feet), regardless of the reason of the fault. Typical defects in a cable could be, for example, a broken cable, partial reflections, a loose cable connector or cable corrosion.

In addition, the measurement shows the degree of the fault in dB. From this information, you can determine the component that has the fault and its seriousness.

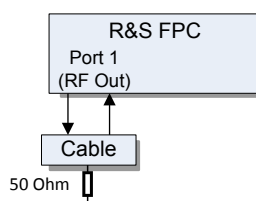

Figure 18-4: Setup of a DTF measurement

To determine the distance to a cable fault, the R&S FPC measures the reflections of the cable under test in the frequency domain. The R&S FPC first determines the magnitude of the reflections for a particular frequency by comparing the phase of the reflected signal and a reference signal created by the tracking generator. It then performs inverse fast fourier transformation (IFFT) on the signal that has been received. In combination with the characteristics of the cable model, the R&S FPC is able to determine the distance the reflections have been traveling.

Because of its sensitivity by first measuring in the frequency domain and subsequent IFFT, the measurement is able to locate faults in a cable accurately. To keep this accuracy, the R&S FPC also accounts for any attenuation that occurs over distance in a cable.

If you are measuring the cable only, make sure to terminate the other end into a load.

For more information about configuring DTF measurements, see [Chapter 18.1.6, "DTF Configuration"](#), on page 177.

Measuring the distance to fault

1. Connect the DUT to the R&S FPC.
Make sure to terminate the cable.
2. Define the frequency parameters for the measurement.
For more information, see [Chapter 18.2, "Frequency Configuration"](#), on page 179.
3. Press the "Meas" key to enter the measurement menu.
4. Select the "Distance To Fault" menu item to start the measurement.
5. Calibrate the cable loss measurement.
For more information, see [Chapter 12, "Calibration"](#), on page 54.
6. After calibration, start the actual measurement (single sweep or continuous sweep).

Displaying the DTF list

The DTF list shows the results of the distance to fault measurement in numerical form.

1. Press the "Meas" key to open the measurement menu.
2. Select the "DTF Config" menu item to open the DTF configuration menu.
3. Select the "DTF List" menu item.
The R&S FPC displays a numerical result display instead of the diagram. The result display contains the peaks that were found during the measurement.

The DTF list contains the following information.

- "Peak": Shows the peak that the results refer to.
- "Distance": Shows the distance from the measurement plane to the peak.
- "Return Loss": Shows the return loss of the peak.

To limit the information in the list, you can define a threshold for the DTF list, so that only peaks above a certain level are included in the list.

4. Select the "DTF List Threshold" menu item to define a threshold level.

The R&S FPC now only shows the peaks that are above the level you have entered.

18.1.5 Measurement Formats

Access: "Meas" > "Format"

You can select one of several formats in which you can display the results of the VNA measurements.

Selecting the measurement format

1. Press the "Meas" key to open the measurement menu.
2. Select the "Format" menu item to access the measurement formats.
3. Select the measurement you like.
The availability of measurement formats depends on the measurement as indicated below.

The R&S FPC supports the following measurement formats.

- "Return Loss"
Shows the magnitude of the reflected power (return loss).
The y-axis shows the return loss in dB. The x-axis represents the selected frequency range.
Available for the [reflection](#) and the [DTF](#) measurement.
- "SWR"
Shows the (voltage) standing wave ratio of the DUT.
The SWR is the ratio of the maximum to the minimum voltages that occur in an electrical transmission line. It is a measure of the reflected power at the input of the DUT.
The logarithmic y-axis shows the SWR (no unit). The x-axis represents the selected frequency range.
Available for the [reflection](#) and the [DTF](#) measurement.
- "Smith Chart"
Shows the measurement results in the Smith chart.
The Smith chart is a circular diagram that primarily shows impedance or reflection characteristics of a DUT.
Available for the [reflection](#) measurement.
- "Phase"
Shows the phase characteristics of the DUT.
The linear y-axis shows the phase in degrees. The x-axis represents the selected frequency range.
Available for the [reflection](#) measurement.
- "Cable Loss"
Shows the magnitude of the reflected power (cable loss).
The cable loss is a measure to determine the attenuation of a cable in a certain frequency range.
The y-axis shows the cable loss in dB. The x-axis represents the selected frequency range.
Available for the [cable loss](#) measurement.
- "Cable Loss (Short+Open)/2"

Shows the magnitude of the reflected power (cable loss). This format is a refined method to calculate the cable loss.

When you select the format, the R&S FPC asks you to calibrate the measurement with a short and an open. This calculation method of cable loss results in a more accurate display of the cable loss curve and helps to avoid measurement errors. Available for the [cable loss](#) measurement.

Unwrapping the phase

You can unwrap the phase to expand the range of the phase.

1. Press the "Meas" key to enter the measurement menu.
2. Select the "Phase" menu item.
3. Select the "Unwrap" menu item.

Displaying the electrical length of the DUT

The electrical length is a numerical result that displayed in addition to another measurement format. As long as it is active, the electrical length is displayed regardless of the currently selected format.

The electrical length is calculated from the phase delay.

$$\tau_{\Phi} = \frac{\Delta\Phi}{2\pi\Delta f}$$

with $\Delta\Phi$ being the phase deviation over the entire frequency range. The electrical length is then derived by:

$$l_{\Phi} = \tau_{\Phi}c_0$$

with c_0 being the velocity of light.

By definition, the electrical length is calculated from the vacuum velocity of light and the differential group delay. Here, the group delay is replaced by the phase delay for two reasons:

- An electrical length must be specified only for non-dispersive DUTs in which phase delay and group delay match.
- Due to the significantly wider aperture, the measurement certainty is an order of magnitude higher in the phase delay measurement than in the group delay measurement.

The result for the electrical length is correct only if the phase difference between two adjacent test points does not exceed 180°.

1. Press the "Meas" key to enter the measurement menu.
2. Select the "Phase" menu item.
3. Select the "Electrical Length" menu item.

The R&S FPC displays the electrical length in the diagram header.

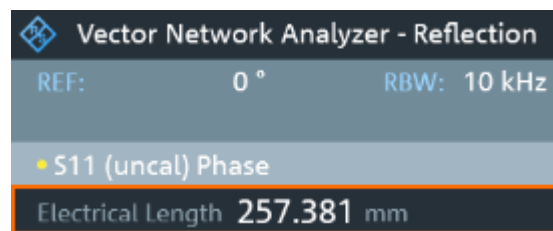

When you evaluate the electrical length, you can define an additional offset for the electrical length to be considered in the measurement.

4. Select the "Length Offset" menu item.
5. Define an offset as necessary.

18.1.6 DTF Configuration

Access: "Meas" > "DTF Config"

For valid measurement results, you need to specify the characteristics of the cable under test like model or frequency range.

Remote commands to configure the bandwidth:

- [Chapter 19.16.1.2, "DTF Configuration"](#), on page 325
- [Cable Models](#)..... 177
- [Cable Length](#)..... 178

18.1.6.1 Cable Models

To determine the speed of propagation, and therefore the precise distance to any faults, you have to specify the cable model that you want to test.

The R&S FPC already comes with an assortment of predefined cable models that you can use without doing anything. If you want to test a cable that is not listed, you can also define custom cable models. You can do so either directly on the R&S FPC or with the "Cable Model Editor" of the R&S InstrumentView software package.

Selecting a predefined cable model

1. Press the "Meas" key to open the measurement menu.
2. Select the "DTF Config" menu item to open the DTF configuration.
3. Select the "Select Cable Model" menu item.
The R&S FPC opens a dialog box to select the cable model.
4. Select the cable model you are testing from the list.
5. Confirm the selection with the "Load" menu item.

The R&S FPC shows the currently selected cable model in the diagram header.

6. Select the "Clear Cable Model" menu item at any time if you want to perform measurements without using a specific cable model.

Creating a custom cable model

The R&S FPC provides two ways to define customized cable models.

The first way is to define a cable model with the "Cable Model Editor" that is part of the R&S InstrumentView software package. The R&S InstrumentView is available for free on the internet. With this software, you can define a cable model on a PC and then transfer it to the R&S FPC. You can then select it just like any other predefined cable model.

If you do not have access to a PC, but still need a cable model that is not stored on the R&S FPC, you can also define the characteristics of a cable temporarily on the R&S FPC itself. It is not possible to save these, however. They are lost as soon as you change them or load another cable model.

1. Press the "Meas" key to open the measurement menu.
2. Select the "DTF Config" menu item to open the DTF configuration.
3. Select the "Define User Model" menu item.
4. Define the cable characteristics with the corresponding menu items.
 - "Frequency": Defines the frequency that the cable characteristics apply to.
 - "Velocity": Defines the velocity of the cable.
 - "Loss": Defines the cable loss at the corresponding frequency.

Note that when you change any cable parameter or load another cable model, the temporary data is lost and you have to define it again for another measurement.

After you have defined the cable characteristics, you still have to activate the use of the customized cable.

5. Select the "User Model" menu item to activate the cable characteristics. The menu item turns light blue to indicate that the cable configuration is active.

18.1.6.2 Cable Length

The R&S FPC uses the cable length to determine the span for the measurement. The longer the cable under test, the smaller the span. Together with the cable model, the cable length is also the basis for the calculation of the cable attenuation. The cable attenuation in turn is necessary for a correct calculation of the reflection magnitude at the cable fault. The cable length also defines the scale of the x-axis.

If the cable length you have set is shorter than the actual cable length, the R&S FPC does not display the faults of the whole cable. A reflection at the end of the cable will not be shown. However, deliberately entering a cable length that is too short is a good way to increase measurement accuracy for a fault that is near to the measurement plane. If the entered cable length is greater than the actual length, the results for lengths beyond the actual cable length are obsolete because they are caused by multiple reflections.

Defining the cable length

The cable length is the sum of the start and stop distances you define for the measurement.

If you do not know the exact length of the cable, define a length that is about 20 % to 50 % larger than the best estimate.

1. Press the "Freq" key to enter the frequency menu.
2. Select the "Start Distance" menu item to define the start of the measurement.
3. Select the "Stop Distance" menu item to define the stop of the measurement.

The maximum cable length that is suitable for measurements depends on the cable attenuation. Because the test signal must be routed twice through the cable, the signal reflected at the cable end arrives with twice the cable attenuation in attenuated form at the input of the power divider. Dynamic range decreases with increasing cable length.

18.2 Frequency Configuration

Access: "Freq"

Access: "Setup" > "Config Overview" > "Stimulus" (selected settings)

Remote commands to configure the frequency:

- [Chapter 19.16.3, "Frequency"](#), on page 335

VNA measurements are done over a certain frequency range on a certain number of discrete [measurement points](#). You can define the frequency range by defining a center frequency and a start and stop frequency or a frequency span, similar to the spectrum application.

The R&S FPC displays the frequency information on the x-axis (except for the DTF measurement, which shows the cable length on the x-axis).

Frequency settings in the VNA application described elsewhere:

- "Center Frequency": ["Defining a center frequency"](#) on page 94
- "Start Frequency" and "Stop Frequency": [Chapter 14.3.2, "Frequency Span"](#), on page 96
- "Manual Span": [Chapter 14.3.2, "Frequency Span"](#), on page 96
- "Full Span": [Chapter 14.3.2, "Frequency Span"](#), on page 96 (not available for DTF measurements)
- "Signal Standard": [Chapter 14.3.3, "Channel Tables"](#), on page 97

Defining the frequency range for DTF measurements

When you define the frequency range in the DTF measurement, it is best to first set the span and then the center frequency.

In the DTF measurement, you can define the span manually or automatically.

1. Press the "Span" key to open the span menu.

2. Select the "Auto Span" menu item.
The R&S FPC automatically calculates the best span for the best length resolution. If the required span is too large for the current center frequency, the R&S FPC changes the center frequency to the smallest possible frequency.
or
3. Select the "Manual Span" menu item.
4. Enter the span you need.
The R&S FPC adopts the new span.
Note that the maximum span you can define depends on the maximum cable distance you have defined and is never greater than the span calculated by the "Auto Span" function. The minimum span that you can set is 10 MHz.
5. Press the "Freq" key to open the frequency menu.
6. Select the "Center Frequency" menu item to define the center frequency.
The span remains the same when you change the center frequency.
Alternatively, you can define the frequency range as a function of the center frequency and the start and stop frequency. The start and stop frequency in that case define the span.
7. Select the "Start Frequency" or "Stop Frequency" menu items to define the span.
The center frequency is automatically adjusted to the frequency whose distance to the start and stop frequency is the same.

Defining the displayed frequency range

After you have defined the span, you can define the frequency range whose results the R&S FPC displays.

In the default configuration, the R&S FPC adjusts the DTF start and DTF stop frequency according to the span and the center frequency. The distance from center frequency to the start and stop frequency is the same. Alternatively, you can directly set a DTF start and DTF stop frequency.

1. Press the "Freq" key to open the frequency menu.
2. Select the "Center Frequency" menu item to define the center frequency.

Coupling frequency and span settings across measurements

By default, the DTF measurement has its own configuration regarding frequency and span settings. The other measurements (reflection S11, transmission S21 and cable loss) use the same frequency and span settings.

You can couple the frequency and span settings across all measurements.

1. Enter the DTF measurement.
2. Press the "Span" key to open the span menu.
3. Select the "Coupled Span" menu item.

The R&S FPC couples the frequency and span settings across all measurements.

18.3 Amplitude Configuration

Access: "Ampt"

Access: "Setup" > "Config Overview" > "Amplitude" (selected settings)

Remote commands to configure the amplitude:

- [Chapter 19.16.2, "Amplitude"](#), on page 328

The R&S FPC provides several methods to adjust the scale of the y-axis in the measurement diagram.

Defining the reference value

The reference value defines the amplitude of the reference line. The unit of the reference is dB.

The R&S FPC indicates the position of the reference value with a triangle at the vertical axis (0.0).

1. Press the "Ampt" key to open the amplitude menu.
2. Select the "Reference" menu item.
3. Define the level of the reference value in dB.

The R&S FPC adjusts the scale of the y-axis accordingly. The position of the trace in the diagram remains the same. The position of the reference line in the diagram also remains the same.

Defining the position of the reference line

The reference position defines the position of the reference line in the diagram. The reference position is a linear value between 0 and 10. Each value represents one horizontal grid line of the diagram. 100 corresponds to the grid line at the top of the diagram, 0 corresponds to the grid line at the bottom.

When you change the reference position, the R&S FPC also shifts the position of the trace by the magnitude of the reference position change. It has no effect on the reference value itself.

1. Press the "Ampt" key to open the amplitude menu.
2. Select the "Range/Ref Pos" menu item.
3. Select the "Ref Position" menu item.
4. Select the line in the grid that corresponds to the reference value.

The R&S FPC adjusts the position of the trace and the position of the triangle that indicates the reference position. The scale of the y-axis remains the same.

Defining the display range

The display range defines the scale of the vertical axis and therefore the amplitude between two horizontal grid lines.

The unit depends on the measurement format.

When you change the display range, you can increase or decrease the amplitude the R&S FPC displays and, for example, include signal parts that are outside the displayed screen area. The positions of the reference value and the trace do not change.

1. Press the "Ampt" key to open the amplitude menu.
2. Select the "Range/Ref Pos" menu item.
3. Select one of the menu items to select the display range you want.
 - "Range": Defines the scope of the y-axis in a logarithmic scale (dB). By default, the y-axis covers 100 dB, but you can increase or decrease the level range.
 - "Linear": Changes the y-axis to a linear scale in %. The range is always 100 %.
 - "SWR Scale": Defines the scope of the y-axis for the [SWR measurement format](#) in terms of a minimum and maximum value that is displayed on the y-axis.
 - "Auto Range": Scales the y-axis in a way that the results fit ideally on the display. The R&S FPC does this by determining the minimum and maximum trace values and scaling the vertical axis according to these values.
4. Select the "Full Scale" menu item to restore the default display range.

18.4 Bandwidth Configuration

Access: "BW"

Remote commands to configure the bandwidth:

- [Chapter 19.16.4, "Bandwidth"](#), on page 336

The measurement bandwidth determines the noise figure of the receiver. Small bandwidths result in higher measurement dynamics for VNA measurements. However, small bandwidths cause longer measurement times because of the settling time of the filter.

Defining the measurement bandwidth

1. Press the "BW" key to open the bandwidth menu.
2. Select one of the "RBW: <x>" menu items.
 - "RBW: Manual"
Opens an input field to select one of the available bandwidths.
If you enter a bandwidth that the R&S FPC does not support, the R&S FPC rounds to the next available bandwidth. Refer to the data sheet for more information on available resolution bandwidths
A manually selected RBW is indicated by a blue dot in front of the "RBW" label in the status bar.

A small rectangular box with a dark background and light text. The text reads "RBW: 1 kHz".

Figure 18-5: Indicator of manual resolution bandwidth

- "RBW: Auto"
Automatically selects an appropriate measurement bandwidth depending on the current [frequency span](#). The automatically selected bandwidth is a compromise between measurement speed and performance.

18.5 Sweep Configuration

Access: "Sweep"

Access: "Setup" > "Config Overview" > "Analysis" (selected settings)

Remote commands to configure the amplitude:

- [Chapter 19.16.5, "Sweep"](#), on page 336

"Sweep" is another word for the measurement process of the analyzer. The VNA application provides several tools to control how the R&S FPC measures the signal.

Selecting the measurement mode

The measurement mode defines how often the data is measured.

In continuous mode, the R&S FPC measures the signal over and over until you stop it deliberately. The measurement results are updated accordingly.

In single mode, the R&S FPC measures the signal once and then stops without updating the results any longer. Another measurement starts only when you deliberately initiate it.

1. Press the "Sweep" key to open the sweep menu.
2. Select the "Continuous Sweep" menu item.
The R&S FPC demodulates the signal continuously.
You can interrupt a continuous measurement by selecting the "Continuous Sweep" menu item again.
3. Select the "Single Sweep" menu item.
The R&S FPC measures the signal once and displays the results of that measurement.
4. You can interrupt the measurement at any time in both measurement modes with the "Hold" menu item. Selecting "Hold" again resumes the measurement.

Defining the number of measurement points

The number of (measurement) points defines the number of measurements performed during a sweep. Thus, it indirectly sets the frequencies of those measurements. The distance from one measurement point to the next depends on the currently set frequency range (span divided by number of points). However, the measurement points are spread evenly over the selected frequency range.

The number of points also defines the resolution and, therefore, the accuracy of the measurement and affects the measurement time. In the default state, the R&S FPC evaluates 201 measurement points. This number allows for fast measurement times and sufficient accuracy. For measurements with a higher or lower frequency resolution, you can change the number of measurement points. Note that measurement times increase if you set a higher number of measurement points.

1. Press the "Sweep" key to open the sweep menu.
2. Select the "Number of Points" menu item.
3. Enter the number of measurement points in the input field.

18.6 Trace Configuration

Access: "Trace"

Access: "Setup" > "Config Overview" > "Analysis" (selected settings)

Remote commands to configure traces:

- [Chapter 19.16.6, "Trace"](#), on page 337

Trace settings in the VNA application described elsewhere:

- "Trace Mode": [Chapter 14.8.1, "Trace Mode"](#), on page 115
(Note that the VNA application only supports "Clear/Write" and "Average" trace modes.)
- "Memory" / "Trace > Memory": [Chapter 14.8.3, "Memory Traces"](#), on page 117

18.7 Marker Configuration

Access: "Mkr"

Access: "Mkr →"

Remote commands to control marker:

- [Chapter 19.16.7, "Marker"](#), on page 337

Marker settings in the VNA application described elsewhere:

- "Mkr" > "Marker <x>": [Chapter 14.9.1, "Marker Positioning"](#), on page 120
- "Mkr" > "Marker Type": ["Selecting the marker type"](#) on page 122
- "Mkr" > "All Markers Off": ["Removing markers or delta markers"](#) on page 122

- "Mkr→" > "Set to <x>": [Chapter 14.9.2, "Automatic Marker Positioning"](#), on page 123
- "Mkr→" > "Marker Tracking": [Chapter 14.9.2, "Automatic Marker Positioning"](#), on page 123
- "Mkr→" > "Search Ranges": [Chapter 14.9.3, "Marker Search Ranges"](#), on page 124

Using markers in the Smith diagram

In addition to the standard marker functionality, the Smith chart also features several marker output formats.

In its default state, the marker position is specified by the marker frequency and complex resistance in Ω . The complex resistance in that case is calculated according to: (real component) + j (imaginary component)

1. Press the "Mkr" key to open the marker menu.
2. Select the "Marker Mode" menu item.
3. Select the marker mode of your choice.
 - "dB Magnitude + Phase"
Shows the magnitude (in dB) and the phase at the current marker position.
 - "Lin Magn + Phase (Rho)"
Shows the converted magnitude (in %) and the phase (in rho) at the current marker position.
 - "Real + Imag (Rho)"
Shows the real and imaginary components at the current marker position.
 - "R + jX"
Shows the real and imaginary components of the impedance at the marker position. The imaginary component is converted to inductance or capacitance. Marker frequency and sign are taken into account.
 - "G + jB"
Shows the real and imaginary components of the admittance at the marker position. The imaginary component is converted to inductance or capacitance. Marker frequency and sign are taken into account.
 - "(R + jX / Z0)"
Shows the real and imaginary components of the standardized impedance.
 - "(G + jB / Y0)"
Shows the real and imaginary components of the standardized admittance.

Selecting the reference impedance for the Smith diagram

The default reference impedance (the matching point in the center of the Smith chart) is 50Ω . It is, however, also possible to measure the reflection on networks with another impedance.

1. Press the "Mkr" key to open the marker menu.
2. Select the "Marker Mode" menu item.

3. Select the "Reference Impedance" menu item to define the reference impedance of your choice.
The value range is from 1 mΩ to 10 kΩ.

18.8 Limit Line Configuration

Access: "Lines"

Remote commands to work with limit lines:

- [Chapter 19.16.8, "Limit Lines"](#), on page 340

Limit line settings in the VNA application described elsewhere:

- "Display Line": [Chapter 14.11, "Display Lines"](#), on page 129 [Chapter 14.9.1, "Marker Positioning"](#), on page 120
- "Show Limit Line": ["Selecting a limit line"](#) on page 131
- "Upper Limit": [Chapter 14.10.4, "Marker Demodulation"](#), on page 128
- "Lower Limit": [Chapter 14.10.4, "Marker Demodulation"](#), on page 128
- "Audio Beep": ["Performing limit checks"](#) on page 132

19 Remote Control

• Remote Control Basics.....	187
• Common Commands.....	202
• Preset.....	206
• Network Connection.....	207
• System Configuration.....	209
• Display Settings.....	215
• Audio Settings.....	215
• Data Management.....	216
• Signal Source Configuration.....	226
• Calibration.....	228
• Applications.....	231
• Remote Commands of the Spectrum Application.....	232
• Remote Commands of the Receiver Application.....	295
• Remote Commands of the Analog Demodulation.....	303
• Remote Commands of the Digital Demodulation.....	313
• Remote Commands of the VNA Application.....	323
• Status Reporting System.....	341

19.1 Remote Control Basics

• Introduction.....	187
• Remote Control Connection.....	190
• Instrument Model and Command Processing.....	191
• SCPI Command Structure.....	192
• Command Sequence and Synchronization.....	200
• Suffix Overview.....	202

19.1.1 Introduction

The R&S FPC supports two different interfaces for remote control.

- **LAN Interface**
The protocol is based on TCP/IP and supports the VXI-11 standard.
- **USB Interface**

The connectors for both interfaces are on the rear panel of the R&S FPC and allow for a connection to a controller for remote control via a local area network (LAN) or directly via USB.

SCPI

SCPI (Standard Commands for Programmable Instruments) commands - messages - are used for remote control. Commands that are not taken from the SCPI standard follow the SCPI syntax rules. The instrument supports the SCPI version 1999. The SCPI standard is based on standard IEEE 488.2 and aims at the standardization of device-

specific commands, error handling and the status registers. The tutorial "Automatic Measurement Control - A tutorial on SCPI and IEEE 488.2" from John M. Pieper (R&S order number 0002.3536.00) provides detailed information on concepts and definitions of SCPI.

The requirements that the SCPI standard places on command syntax, error handling and configuration of the status registers are explained in detail in the following sections. Tables provide a fast overview of the bit assignment in the status registers. The tables are supplemented by a comprehensive description of the status registers.

VISA

VISA is a standardized software interface library providing input and output functions to communicate with instruments. The I/O channel (LAN or USB) is selected at initialization time by a channel-specific resource string.

It is recommended that you use the R&S VISA driver. You can get R&S VISA, including the documentation, from the Rohde & Schwarz internet pages.



Resetting the R&S FPC

Manual operation is designed for maximum operating convenience.

The priority of remote control, however, is the "predictability" of the device status.

Therefore, control programs should always define an initial device status (for example with *RST) before implementing the required settings.

19.1.1.1 LAN Interface

To be integrated in a LAN, the instrument is equipped with a standard LAN interface, consisting of a connector, a network interface and protocols (VXI-11).

Instrument access via VXI-11 is usually achieved from high level programming platforms by using VISA as an intermediate abstraction layer. VISA encapsulates the low level VXI-11 (LAN) or USB function calls and thus makes the transport interface transparent for the user. The necessary VISA library is available for download from the Rohde & Schwarz internet pages.

19.1.1.2 USB Interface

For remote control via the USB connection, the PC and the instrument must be connected via the USB interface. The required driver comes with the R&S InstrumentView software package and is automatically installed on the PC with the software package.

The driver addresses the instrument via the USB interface with the fix IP address 172.16.10.10.

In addition, a remote control connection via the SCPI interface requires the VISA library to be installed on the PC.

19.1.1.3 Protocols

VXI-11 basics

The VXI-11 standard is based on the ONC-RPC protocol which in turn relies on TCP/IP as the network/transport layer. The TCP/IP network protocol and the associated network services are preconfigured. TCP/IP ensures connection-oriented communication, where the order of the exchanged messages is adhered to and interrupted links are identified. With this protocol, messages cannot be lost.

Remote control of an instrument via a network is based on standardized protocols which follow the OSI reference model (see [Figure 19-1](#)).

Application	SCPI
Presentation	XDR (VXI-11)
Session	ONC-RPC
Transport	TCP / UDP
Network	IP
Data Link	Ethernet/802.3
Physical	802.3/10BASE-T

Figure 19-1: Example for LAN remote control based on the OSI reference model

Based on TCP/UDP, messages between the controller and the instrument are exchanged via open network computing (ONC) - remote procedure calls (RPC). With XDR (VXI-11), legal RPC messages are known as VXI-11 standard. Based on this standard, messages are exchanged between the controller and the instrument. The messages are identical with SCPI commands.

They can be organized in four groups

- Program messages (control command to the instrument)
- Response messages (values returned by the instrument)
- Service request (spontaneous queries of the instrument)
- Low-level control messages (interface messages)

A VXI-11 link between a controller and an instrument uses three channels: core, abort and interrupt channel. Instrument control is mainly performed on the core channel (program, response and low-level control messages). The abort channel is used for immediate abort of the core channel; the interrupt channel transmits spontaneous service requests of the instrument. Link setup itself is very complex. For more details, refer to the VXI-11 specification.

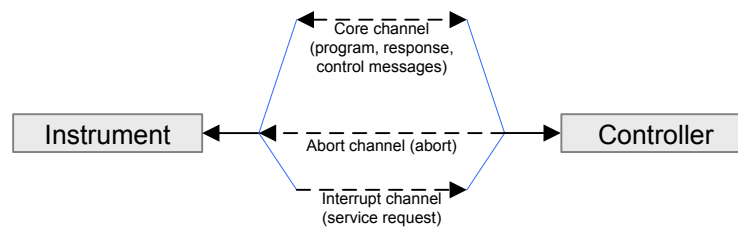

Figure 19-2: VXI-11 channels between instrument and controller

The number of controllers that can address an instrument is practically unlimited in the network. In the instrument, the individual controllers are clearly distinguished. This distinction continues up to the application level in the controller, i.e. two applications on a computer are identified by the instrument as two different controllers.

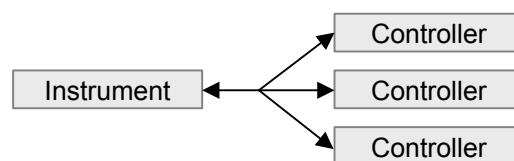

Figure 19-3: Remote control via LAN from several controllers

The controllers can lock and unlock the instrument for exclusive access. This regulates access to the instrument of several controllers.

19.1.2 Remote Control Connection

The short and simple operating sequence below shows how to put the instrument into operation and quickly set its basic functions. You can find out the current IP address for LAN operation in the setup menu ("Setup" > "Instrument Setup"). In case of USB connection the IP address is always 172.16.10.10.

1. Connect the R&S FPC to the LAN or directly to the controller via USB.
2. Turn on the R&S FPC.
3. Write and start the program below on the controller.

The instrument performs a sweep in the frequency range of 95 MHz to 105 MHz.

```
//open default resource manager
status = viOpenDefaultRM(defaultRM)
//in case of USB connection
status = viOpen(DefaultRM, "TCPIP::172.16.10.10", 0, 0, vi)
//in case of a LAN connection, with xxx.xxx.xxx.xxx = IP address
status = viopen(DefaultRM, "TCPIP::xxx.xxx.xxx.xxx", 0, 0, vi)
//reset instrument and clear status registers
cmd = "*RST;*CLS"
status = viWrite(vi, Cmd, Len(Cmd), retCount)
//set center frequency to 100 MHz
```

```

cmd = "FREQ:CENT 100MHz"
status = viWrite(vi, Cmd, Len(Cmd), retCount)
//set span to 10 MHz
cmd = "FREQ:SPAN 10MHz"
status = viWrite(vi, Cmd, Len(Cmd), retCount)
//set reference level to -10 dBm
cmd = "DISP:TRAC:Y:RLEV -10dBm"
status = viWrite(vi, Cmd, Len(Cmd), retCount)
viclose vi
viclose default RM

```

Changing the IP address

In order to operate the instrument via remote control, it must be accessed via LAN (IP address) or USB (fixed IP address). If the factory-set remote control address does not fit in the network environment, it can be changed. Refer to [Chapter 9.2, "Network Configuration"](#), on page 39 for instructions on how to change the IP address.

19.1.3 Instrument Model and Command Processing

The block diagram in [Figure 19-4](#) shows how SCPI commands are serviced in the instrument. The individual components work independently and simultaneously. They communicate with each other with so-called "messages".

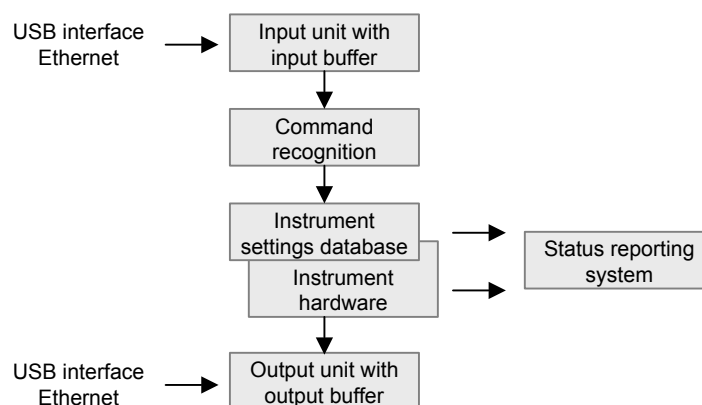

Figure 19-4: Instrument model in case of remote control

19.1.3.1 Input Unit

The input unit receives commands character by character from the controller and collects them in the input buffer. The input unit sends a message to the command recognition as soon as the input buffer is full or as soon as it receives a delimiter, <PROGRAM MESSAGE TERMINATOR>, as defined in IEEE 488.2, or the interface message DCL.

If the input buffer is full, the traffic is stopped and the data received up to then are processed. Subsequently the traffic is continued. If, however, the buffer is not yet full when receiving the delimiter, the input unit can already receive the next command during

command recognition and execution. The receipt of DCL clears the input buffer and immediately resets the command recognition.

19.1.3.2 Command Recognition

Here the expression "instrument hardware" denotes the part of the instrument fulfilling the actual instrument function - signal generation, measurement etc. The controller is not included. The term "data base" denotes a database that manages all the parameters and associated settings required for setting the instrument hardware.

Setting commands lead to an alteration in the data set. The data set management enters the new values (for example frequency) into the data set, however, only passes them on to the hardware when requested by the command recognition. This only takes place at the end of a program message.

The data are checked for compatibility with the current instrument settings before they are transmitted to the instrument hardware. If the execution is not possible, an "execution error" is signaled to the status reporting system. The corresponding settings are discarded.

Before passing on the data to the hardware, the settling bit in the `STATUS:OPERation` register is set (refer to `STATUS:OPERation` register). The hardware executes the settings and resets the bit again as soon as the new state has settled. This fact can be used to synchronize command servicing.

Queries induce the data set management to send the desired data to the output unit.

19.1.3.3 Output Unit

The output unit collects the information requested by the controller, which it receives from the data base management. It processes it according to the SCPI rules and makes it available in the output buffer.

If the instrument is addressed as a talker without the output buffer containing data or awaiting data from the data base management, the output unit sends error message `Query UNTERMINATED` to the status reporting system. No data are sent to the controller, the controller waits until it has reached its time limit. This behavior is defined by IEEE 488.2 and SCPI.

19.1.4 SCPI Command Structure

SCPI commands consist of a header and, in most cases, one or more parameters. The header and the parameters are separated by a "white space" (ASCII code 0 to 9, 11 to 32 decimal, e.g. blank). The headers may consist of several mnemonics (keywords). Queries are formed by appending a question mark directly to the header.

The commands can be either device-specific or device-independent (common commands). Common and device-specific commands differ in their syntax.

19.1.4.1 Syntax for Common Commands

Common (= device-independent) commands consist of a header preceded by an asterisk (*), and possibly one or more parameters.

Table 19-1: Examples of common commands

*RST	RESET	Resets the instrument.
*ESE	EVENT STATUS ENABLE	Sets the bits of the event status enable registers.
*ESR?	EVENT STATUS QUERY	Queries the contents of the event status register.
*IDN?	IDENTIFICATION QUERY	Queries the instrument identification string.

19.1.4.2 Syntax for Device-Specific Commands



Not all commands used in the following examples are necessarily implemented in the instrument. For demonstration purposes only, assume the existence of the following commands for this section:

- DISPLAY[:WINDow<1...4>]:MAXimize <Boolean>
- FORMAT:READings:DATA <type>[,<length>]
- HCOpy:DEvice:COLor <Boolean>
- HCOpy:DEvice:CMAP:COLor:RGB <red>,<green>,<blue>
- HCOpy[:IMMediate]
- HCOpy:ITEM:ALL
- HCOpy:ITEM:LAbel <string>
- HCOpy:PAGE:DIMensions:QUADrant [<N>]
- HCOpy:PAGE:ORientation LANDscape | PORTrait
- HCOpy:PAGE:SCALE <numeric value>
- MMEMemory:COpy <file_source>,<file_destination>
- SENSE:BANDwidth|BWIDth[:RESolution] <numeric_value>
- SENSE:FREQuency:STOP <numeric value>
- SENSE:LIST:FREQuency <numeric_value>{,<numeric_value>}

- [Long and short form](#)..... 193
- [Numeric Suffixes](#)..... 194
- [Optional Mnemonics](#)..... 194

Long and short form

The mnemonics feature a long form and a short form. The short form is marked by upper case letters, the long form corresponds to the complete word. Either the short form or the long form can be entered; other abbreviations are not permitted.

Example:

HCOpy:DEvice:COLor ON is equivalent to HCOP:DEV:COL ON.



Case-insensitivity

Upper case and lower case notation only serves to distinguish the two forms in the manual, the instrument itself is case-insensitive.

Numeric Suffixes

If a command can be applied to multiple instances of an object, e.g. specific channels or sources, the required instances can be specified by a suffix added to the command. Numeric suffixes are indicated by angular brackets (<1...4>, <n>, <i>) and are replaced by a single value in the command. Entries without a suffix are interpreted as having the suffix 1.

Example:

Definition: `HCOPY:PAGE:DIMensions:QUADrant [<N>]`

Command: `HCOP:PAGE:DIM:QUAD2`

This command refers to the quadrant 2.



Different numbering in remote control

For remote control, the suffix may differ from the number of the corresponding selection used in manual operation. SCPI prescribes that suffix counting starts with 1. Suffix 1 is the default state and used when no specific suffix is specified.

Some standards define a fixed numbering, starting with 0. If the numbering differs in manual operation and remote control, it is indicated for the corresponding command.

Optional Mnemonics

Some command systems permit certain mnemonics to be inserted into the header or omitted. These mnemonics are marked by square brackets in the description. The instrument must recognize the long command to comply with the SCPI standard. Some commands are considerably shortened by these optional mnemonics.

Example:

Definition: `HCOPY[:IMMEDIATE]`

Command: `HCOP:IMM` is equivalent to `HCOP`



Optional mnemonics with numeric suffixes

Do not omit an optional mnemonic if it includes a numeric suffix that is relevant for the effect of the command.

Example:

Definition: `DISPlay[:WINDow<1...4>]:MAXimize <Boolean>`

Command: `DISP:MAX ON` refers to window 1.

In order to refer to a window other than 1, you must include the optional `WINDow` parameter with the suffix for the required window.

`DISP:WIND2:MAX ON` refers to window 2.

19.1.4.3 SCPI Parameters

Many commands are supplemented by a parameter or a list of parameters. The parameters must be separated from the header by a "white space" (ASCII code 0 to 9, 11 to 32 decimal, e.g. blank).

The parameters required for each command and the allowed range of values are specified in the command description.

Allowed parameters are:

- [Numeric Values](#)..... 195
- [Special Numeric Values](#)..... 196
- [Boolean Parameters](#)..... 196
- [Text Parameters](#)..... 197
- [Character Strings](#)..... 197
- [Block Data](#)..... 197

Numeric Values

Numeric values can be entered in any form, i.e. with sign, decimal point and exponent. Values exceeding the resolution of the instrument are rounded up or down. The mantissa may comprise up to 255 characters, the exponent must lie inside the value range -32000 to 32000. The exponent is introduced by an "E" or "e". Entry of the exponent alone is not allowed.

Example:

`SENS:FREQ:STOP 1500000 = SENS:FREQ:STOP 1.5E6`

Units

For physical quantities, the unit can be entered. If the unit is missing, the basic unit is used. Allowed unit prefixes are:

- G (giga)
- MA (mega), MOHM, MHZ
- K (kilo)
- M (milli)
- U (micro)

- N (nano)

Example:

```
SENSe:FREQ:STOP 1.5GHz = SENSe:FREQ:STOP 1.5E9
```

Some settings allow relative values to be stated in percent. According to SCPI, this unit is represented by the `PCT` string.

Example:

```
HCOP:PAGE:SCAL 90PCT
```

Special Numeric Values

The following mnemonics are special numeric values. In the response to a query, the numeric value is provided.

- **MIN and MAX:** denote the minimum and maximum value.
- **DEF:** denotes a preset value which has been stored in the EPROM. This value conforms to the default setting, as it is called by the `*RST` command.
- **UP and DOWN:** increases or reduces the numeric value by one step. The step width can be specified via an allocated step command for each parameter which can be set via `UP` and `DOWN`.
- **INF and NINF:** INfinity and negative INfinity (NINF) represent the numeric values $9.9E37$ or $-9.9E37$, respectively. `INF` and `NINF` are only sent as instrument responses.
- **NAN:** Not A Number (NAN) represents the value $9.91E37$. `NAN` is only sent as a instrument response. This value is not defined. Possible causes are the division of zero by zero, the subtraction of infinite from infinite and the representation of missing values.

Example:

Setting command: `SENSe:LIST:FREQ MAXimum`

Query: `SENS:LIST:FREQ?`

Response: `3.5E9`

**Queries for special numeric values**

The numeric values associated to `MAXimum`/`MINimum`/`DEFault` can be queried by adding the corresponding mnemonic after the quotation mark.

Example: `SENSe:LIST:FREQ? MAXimum`

Returns the maximum numeric value as a result.

Boolean Parameters

Boolean parameters represent two states. The "ON" state (logically true) is represented by "ON" or a numeric value 1. The "OFF" state (logically untrue) is represented by "OFF" or the numeric value 0. The numeric values are provided as the response for a query.

Example:

Setting command: `HCOPY:DEV:COL ON`

Query: `HCOPY:DEV:COL?`

Response: 1

Text Parameters

Text parameters observe the syntactic rules for mnemonics, i.e. they can be entered using a short or long form. Like any parameter, they have to be separated from the header by a white space. In the response to a query, the short form of the text is provided.

Example:

Setting command: `HCOPY:PAGE:ORIENTATION LANDscape`

Query: `HCOPY:PAGE:ORI?`

Response: LAND

Character Strings

Strings must always be entered in quotation marks (' or ").

Example:

`HCOPY:ITEM:LABEL "Test1"`

`HCOPY:ITEM:LABEL 'Test1'`

Block Data

Block data is a format which is suitable for the transmission of large amounts of data. For example, a command using a block data parameter has the following structure:

```
FORMat:READings:DATA #45168xxxxxxxx
```

The ASCII character # introduces the data block. The next number indicates how many of the following digits describe the length of the data block. In the example the 4 following digits indicate the length to be 5168 bytes. The data bytes follow. During the transmission of these data bytes all end or other control signs are ignored until all bytes are transmitted.

#0 specifies a data block of indefinite length. The use of the indefinite format requires a `NL^END` message to terminate the data block. This format is useful when the length of the transmission is not known or if speed or other considerations prevent segmentation of the data into blocks of definite length.

19.1.4.4 Overview of Syntax Elements

The following tables provide an overview of the syntax elements and special characters.

Table 19-2: Syntax elements

:	The colon separates the mnemonics of a command.
;	The semicolon separates two commands of a command line. It does not alter the path.
,	The comma separates several parameters of a command.
?	The question mark forms a query.
*	The asterisk marks a common command.
' '	Quotation marks introduce a string and terminate it (both single and double quotation marks are possible).
#	The hash symbol introduces binary, octal, hexadecimal and block data. <ul style="list-style-type: none"> • Binary: #B10110 • Octal: #O7612 • Hexa: #HF3A7 • Block: #21312
	A "white space" (ASCII-Code 0 to 9, 11 to 32 decimal, e.g. blank) separates the header from the parameters.

Table 19-3: Special characters

	<p>Parameters</p> <p>A vertical stroke in parameter definitions indicates alternative possibilities in the sense of "or". The effect of the command differs, depending on which parameter is used.</p> <p>Example:</p> <p>Definition:HCOPY:PAGE:ORIENTATION LANDscape PORTRait</p> <p>Command HCOP:PAGE:ORI LAND specifies landscape orientation</p> <p>Command HCOP:PAGE:ORI PORT specifies portrait orientation</p> <p>Mnemonics</p> <p>A selection of mnemonics with an identical effect exists for several commands. These mnemonics are indicated in the same line; they are separated by a vertical stroke. Only one of these mnemonics needs to be included in the header of the command. The effect of the command is independent of which of the mnemonics is used.</p> <p>Example:</p> <p>DefinitionSENSE:BANDwidth BWIDth[:RESolution] <numeric_value></p> <p>The two following commands with identical meaning can be created:</p> <p>SENS:BAND:RES 1</p> <p>SENS:BWID:RES 1</p>
[]	<p>Mnemonics in square brackets are optional and may be inserted into the header or omitted.</p> <p>Example: HCOPY[:IMMEDIATE]</p> <p>HCOP: IMM is equivalent to HCOP</p>
{ }	<p>Parameters in curly brackets are optional and can be inserted once or several times, or omitted.</p> <p>Example: SENSE:LIST:FREQUENCY <numeric_value>{,<numeric_value>}</p> <p>The following are valid commands:</p> <p>SENS:LIST:FREQ 10</p> <p>SENS:LIST:FREQ 10,20</p> <p>SENS:LIST:FREQ 10,20,30,40</p>

19.1.4.5 Structure of a Command Line

A command line may consist of one or several commands. It is terminated by one of the following:

- <New Line>
- <New Line> with EOI
- EOI together with the last data byte

Several commands in a command line must be separated by a semicolon ";".

Example:

```
MMEM:COPY "Test1", "MeasurementXY";:HCOP:ITEM ALL
```

This command line contains two commands. The first command belongs to the MMEM system, the second command belongs to the HCOP system. If the next command belongs to a different command system, the semicolon is followed by a colon.

Example:

```
HCOP:ITEM ALL;:HCOP:IMM
```

This command line contains two commands. Both commands are part of the HCOP command system, i.e. they have one level in common.

If the successive commands belong to the same system, having one or several levels in common, the command line can be abbreviated. When abbreviating the command line, the second command begins with the level below HCOP. The colon after the semicolon is omitted. The abbreviated form of the command line reads as follows:

```
HCOP:ITEM ALL;IMM
```

Example:

```
HCOP:ITEM ALL
```

```
HCOP:IMM
```

A new command line always begins with the complete path.

19.1.4.6 Responses to Queries

A query is defined for each setting command unless explicitly specified otherwise. It is formed by adding a question mark to the associated setting command. According to SCPI, the responses to queries are partly subject to stricter rules than in standard IEEE 488.2.

- The requested parameter is transmitted without a header.
Example: `HCOP:PAGE:ORI?`, **Response:** `LAND`
- Maximum values, minimum values and all other quantities that are requested via a special text parameter are returned as numeric values.
Example: `SENSe:FREQuency:STOP? MAX`, **Response:** `3.5E9`
- Numeric values are output without a unit. Physical quantities are referred to the basic units or to the units set using the `Unit` command. The response `3.5E9` in the previous example stands for 3.5 GHz.

- Truth values (Boolean values) are returned as 0 (for OFF) and 1 (for ON).
Example:
 Setting command: `HCOPY:DEV:COL ON`
 Query: `HCOPY:DEV:COL?`
 Response: 1
- Text (character data) is returned in a short form.
Example:
 Setting command: `HCOPY:PAGE:ORIENTATION LANDscape`
 Query: `HCOPY:PAGE:ORI?`
 Response: LAND
- Invalid numerical results
 In some cases, particularly when a result consists of multiple numeric values, invalid values are returned as 9.91E37 (not a number).

19.1.5 Command Sequence and Synchronization

IEEE 488.2 defines a distinction between overlapped and sequential commands:

- A sequential command is one which finishes executing before the next command starts executing. Commands that are processed quickly are usually implemented as sequential commands.
- An overlapping command is one which does not automatically finish executing before the next command starts executing. Usually, overlapping commands take longer to process and allow the program to do other tasks while being executed. If overlapping commands do have to be executed in a defined order, e.g. in order to avoid wrong measurement results, they must be serviced sequentially. This is called synchronization between the controller and the instrument.

Setting commands within one command line, even though they may be implemented as sequential commands, are not necessarily serviced in the order in which they have been received. In order to make sure that commands are actually carried out in a certain order, each command must be sent in a separate command line.

Example: Commands and queries in one message

The response to a query combined in a program message with commands that affect the queried value is not predictable.

The following commands always return the specified result:

```
:FREQ:STAR 1GHZ;SPAN 100;:FREQ:STAR?
```

Result:

```
1000000000 (1 GHz)
```

Whereas the result for the following commands is not specified by SCPI:

```
:FREQ:STAR 1GHz;STAR?;SPAN 1000000
```

The result could be the value of `START` before the command was sent since the instrument might defer executing the individual commands until a program message terminator is received. The result could also be 1 GHz if the instrument executes commands as they are received.



As a general rule, send commands and queries in different program messages.

Example: Overlapping command with *OPC

The instrument implements `INITiate[:IMMediate]` as an overlapped command. Assuming that `INITiate[:IMMediate]` takes longer to execute than `*OPC`, sending the following command sequence results in initiating a sweep and, after some time, setting the `OPC` bit in the `ESR`:

```
INIT; *OPC.
```

Sending the following commands still initiates a sweep:

```
INIT; *OPC; *CLS
```

However, since the operation is still pending when the instrument executes `*CLS`, forcing it into the "Operation Complete Command Idle" State (OCIS), `*OPC` is effectively skipped. The `OPC` bit is not set until the instrument executes another `*OPC` command.

19.1.5.1 Preventing Overlapping Execution

To prevent an overlapping execution of commands, one of the commands `*OPC`, `*OPC?` or `*WAI` can be used. All three commands cause a certain action only to be carried out after the hardware has been set. The controller can be forced to wait for the corresponding action to occur.

Table 19-4: Synchronization using *OPC, *OPC? and *WAI

Com-mand	Action	Programming the controller
*OPC	Sets the Operation Complete bit in the ESR after all previous commands have been executed.	<ul style="list-style-type: none"> Setting bit 0 in the ESE Setting bit 5 in the SRE Waiting for service request (SRQ)
*OPC?	Stops command processing until 1 is returned. This occurs when all pending operations are completed.	Send *OPC? directly after the command whose processing must be terminated before other commands can be executed.
*WAI	Stops further command processing until all commands sent before *WAI have been executed.	Send *WAI directly after the command whose processing must be terminated before other commands are executed.

Command synchronization using `*WAI` or `*OPC?` is a good choice if the overlapped command takes only little time to process. The two synchronization commands simply block overlapped execution of the command. Append the synchronization command to the overlapping command, for example:

```
SINGle; *OPC?
```

For time consuming overlapped commands, you can allow the controller or the instrument to do other useful work while waiting for command execution. Use one of the following methods:

***OPC with a service request**

1. Set the OPC mask bit (bit no. 0) in the ESE: *ESE 1
2. Set bit no. 5 in the SRE: *SRE 32 to enable ESB service request.
3. Send the overlapped command with *OPC .
4. Wait for a service request.

The service request indicates that the overlapped command has finished.

***OPC? with a service request**

1. Set bit no. 4 in the SRE: *SRE 16 to enable MAV service request.
2. Send the overlapped command with *OPC?.
3. Wait for a service request.

The service request indicates that the overlapped command has finished.

Event status register (ESE)

1. Set the OPC mask bit (bit no. 0) in the ESE: *ESE 1
2. Send the overlapped command without *OPC, *OPC? or *WAI.
3. Poll the operation complete state periodically (with a timer) using the sequence:
*OPC; *ESR?

A return value (LSB) of 1 indicates that the overlapped command has finished.

19.1.6 Suffix Overview

Table 19-5: Overview of SCPI suffixes

Suffix	Description	Range
<m>	Selects a marker	1...6
<n>	Selects a window	irrelevant
<t>	Selects a trace	1...2
<td>	Selects the transducer type (primary or secondary)	1...2

19.2 Common Commands

*CLS.....	203
*ESE.....	203
*ESR?.....	203
*IDN?.....	203
*IST?.....	204

*OPC.....	204
*OPT?.....	204
*RST.....	204
*SRE.....	204
*STB?.....	205
*TRG.....	205
*TST?.....	205
*WAI.....	205

*CLS

Clear status

Sets the status byte (STB), the standard event register (ESR) and the `EVENT` part of the `QUESTIONABLE` and the `OPERATION` registers to zero. The command does not alter the mask and transition parts of the registers. It clears the output buffer.

Usage: Setting only

*ESE <Value>

Event status enable

Sets the event status enable register to the specified value. The query returns the contents of the event status enable register in decimal form.

Parameters:

<Value> Range: 0 to 255

*ESR?

Event status read

Returns the contents of the event status register in decimal form and then sets the register to zero.

Return values:

<Contents> Range: 0 to 255

Usage: Query only

*IDN?

Identification

Returns the instrument identification.

Return values:

<ID> "Rohde&Schwarz,<device type>,<part number>/<serial number>,<firmware version>"

Example: Rohde&Schwarz,FPC1000,1328.6660K02/xxxxxx,1.00

Usage: Query only

***IST?**

Individual status query

Returns the contents of the IST flag in decimal form. The IST flag is the status bit which is sent during a parallel poll.

Return values:

<ISTflag> 0 | 1

Usage: Query only

***OPC**

Operation complete

Sets bit 0 in the event status register when all preceding commands have been executed. This bit can be used to initiate a service request. The query writes a "1" into the output buffer when all preceding commands have been executed, which is useful for command synchronization.

***OPT?**

Option identification query

Queries the options included in the instrument. For a list of all available options and their description, refer to the data sheet.

Return values:

<Options> The query returns a list of all installed and activated options, separated by commas, where:
B<number> describes hardware options.
K<number> describes software options.

Usage: Query only

***RST**

Reset

Sets the instrument to a defined default status. The default settings are indicated in the description of commands.

The command is equivalent to `SYSTEM:PRESet`.

Usage: Setting only

***SRE <Contents>**

Service request enable

Sets the service request enable register to the indicated value. This command determines under which conditions a service request is triggered.

Parameters:

<Contents> Contents of the service request enable register in decimal form.
Bit 6 (MSS mask bit) is always 0.
Range: 0 to 255

***STB?**

Status byte query

Reads the contents of the status byte in decimal form.

Usage: Query only

***TRG**

Trigger

Triggers all actions waiting for a trigger event. In particular, *TRG generates a manual trigger signal. This common command complements the commands of the TRIGger subsystem.

*TRG corresponds to the INITiate:IMMediate command.

Usage: Event

***TST?**

Self-test query

Initiates self-tests of the instrument and returns an error code.

Return values:

<ErrorCode> **integer > 0 (in decimal format)**
An error occurred.
0
No errors occurred.

Usage: Query only

***WAI**

Wait to continue

Prevents servicing of the subsequent commands until all preceding commands have been executed and all signals have settled (see also command synchronization and *OPC).

Usage: Event

19.3 Preset

SYSTem:PRESet	206
SYSTem:PRESet:FACTory	206
SYSTem:PRESet:MODE	206
SYSTem:PRESet:USER	207

SYSTem:PRESet

Resets the R&S FPC to its default state.

The R&S FPC supports two different preset modes (default preset or user-defined preset). You can select the preset mode with [SYSTem:PRESet:MODE](#).

Example: //Reset the R&S FPC
 SYST:PRESet

Usage: Event

Manual operation: See "[Preset](#)" on page 355

SYSTem:PRESet:FACTory

This command initiates an instrument reset back to factory settings.

Example: //Reset the R&S FPC to its factory settings
 SYST:PRESet:FACT

Usage: Event

Manual operation: See "[Reset](#)" on page 357

SYSTem:PRESet:MODE <Mode>

This command selects the preset mode.

Parameters:

<Mode>

DEFault

Default preset state.

USER

User-defined preset state.

You can select a custom preset configuration with [SYSTem:PRESet:USER](#).

Example: //Select a user defined preset
 SYST:PRESet:MODE USER

Manual operation: See "[Preset Key](#)" on page 357

SYSTem:PRESet:USER <Preset>

This command selects a dataset whose configuration serves as a user-defined preset state.

Prerequisites for this command

- Select user-defined preset mode (`SYSTem:PRESet:MODE`).

Parameters:

<Preset> String containing the path and name of the file, including the file-name extension (.set).
The path and file name comply with Windows conventions. Note that the folder references in the string are case-sensitive.

Example: //Select user-defined preset state
SYST:PRESet:MODE USER
SYST:PRESet:USER '\Public\funny\result.set'

Manual operation: See "Preset Key" on page 357

19.4 Network Connection

<code>SYSTem:COMMunicate:LAN:ETHernet?</code>	207
<code>SYSTem:COMMunicate:LAN:GATeway</code>	207
<code>SYSTem:COMMunicate:LAN:SUBMask</code>	208
<code>SYSTem:COMMunicate:SOCKet:ADDRess</code>	208
<code>SYSTem:COMMunicate:SOCKet:DHCP[:STATe]</code>	208

SYSTem:COMMunicate:LAN:ETHernet?

This command queries the MAC address of the R&S FPC.

Return values:

<MacAddress> String containing the MAC address.

Example: //Query the MAC address
SYST:COMM:LAN:ETH?

Usage: Query only

Manual operation: See "LAN" on page 356

SYSTem:COMMunicate:LAN:GATeway <Gateway>

This command selects the gateway in a LAN.

Prerequisites for this command

- Turn off DHCP (`SYSTem:COMMunicate:SOCKet:DHCP[:STATe]`).

Parameters:

<Gateway> String containing the identifier of the gateway.

Example:

```
//Select gateway
SYST:COMM:SOCK:DHCP OFF
SYST:COMM:LAN:GAT '0.0.0.0'
```

Manual operation: See "LAN" on page 356

SYSTem:COMMunicate:LAN:SUBMask <SubnetMask>

This command defines the subnet mask of the R&S FPC.

Prerequisites for this command

- Turn off DHCP (`SYSTem:COMMunicate:SOCKet:DHCP[:STATe]`).

Parameters:

<SubnetMask> String containing the subnet mask ('x.x.x.x').
*RST: '255.255.255.0'

Example:

```
//Select subnet mask
SYST:COMM:SOCK:DHCP OFF
SYST:COMM:LAN:SUBM '255.255.255.0'
```

Manual operation: See "LAN" on page 356

SYSTem:COMMunicate:SOCKet:ADDRess <IPAddress>

This command defines the IP address of the R&S FPC.

Prerequisites for this command

- Turn off DHCP (`SYSTem:COMMunicate:SOCKet:DHCP[:STATe]`).

Parameters:

<IPAddress> String containing the IP address ('x.x.x.x').
*RST: '172.76.68.24'

Example:

```
//Define IP address
SYST:COMM:SOCK:DHCP OFF
SYST:COMM:SOCK:ADDR '192.0.2.0'
```

Manual operation: See "LAN" on page 356

SYSTem:COMMunicate:SOCKet:DHCP[:STATe] <State>

This command turns the Dynamic Host Configuration Protocol (DHCP) on and off.

When you turn on DHCP, the network automatically assigns IP address, subnet mask and gateway to the R&S FPC.

Parameters:

<State> ON | OFF | 1 | 0
*RST: ON | 1

Example:

```
//Activate DHCP
SYST:COMM:SOCK:DHCP ON
```

Manual operation: See "LAN" on page 356

19.5 System Configuration

DIAGnostic[:SERvice]:IDENtification:MATerial?	209
DIAGnostic[:SERvice]:IDENtification:SERial?	209
DISPlay:DATE:FORMat	210
SYSTem:BNC:MODE	210
SYSTem:DATE	210
SYSTem:ERRor:ALL?	211
SYSTem:ERRor:CODE:ALL?	211
SYSTem:ERRor:CODE[:NEXT]?	211
SYSTem:ERRor:COUNT?	212
SYSTem:ERRor[:NEXT]?	212
SYSTem:HELP:HEADers?	212
SYSTem:HELP:SYNTax?	212
SYSTem:LANGuage	213
SYSTem:LANGuage:CATalog?	213
SYSTem:MEMory:FREE?	213
SYSTem:MEMory:TOTal?	213
SYSTem:STORe:USED?	213
SYSTem:STORe:FREE?	213
SYSTem:STORe:TOTal?	213
SYSTem:MEMory:USED?	213
SYSTem:TIME	214
SYSTem:TZONee	214
UNIT<n>:LENGth	214

DIAGnostic[:SERvice]:IDENtification:MATerial?

This command queries the material number of the device.

Return values:

<MaterialNumber> String containing the material number of the connected device.

Example:

```
//Query material number
DIAG:IDEN:MAT?
```

Usage:

Query only

DIAGnostic[:SERvice]:IDENtification:SERial?

This command queries the serial number of the device.

Return values:

<SerialNumber> String containing the serial number of the connected device.

Example:

```
//Query serial number
DIAG:IDEN:SER?
```

Usage: Query only

DISPlay:DATE:FORMat <DateFormat>

This command selects the date format.

Parameters:

<DateFormat> DDMMyyyy | MMDDyyyy
 *RST: DDMMyyyy

Example: //Select date format
 DISP:DATE:FORM DDMMyyyy

Manual operation: See "[Regional](#)" on page 356

SYSTem:BNC:MODE <Usage>

This command configures the BNC connector on the rear panel of the R&S FPC.

Parameters:

<Usage> **REFerence**
 Input for external reference signal.
TRIGger
 Input for external trigger.
 *RST: TRIGger

Example: //Configure the BNC connector
 SYST:BNC1:MODE TRIG

Manual operation: See "[Hardware](#)" on page 356

SYSTem:DATE <Year>, <Month>, <Day>

This command defines the date of the system calendar.

Parameters:

<Year> <numeric value> (integer)
 Range: 2000 to 2099
 <Month> <numeric value> (integer)
 Range: 1 to 12
 <Day> <numeric value> (integer)
 Range: 1 to 31

Example: //Change the system date
 SYST:DATE 2020,6,1

Manual operation: See "[Date and Time](#)" on page 356

SYSTem:ERRor:ALL?

This command queries the complete error queue.

The number of values depends on the length of the queue.

If the error queue is empty, the command returns 0, 'No error'.

Return values:

<ErrorNumber> Number that contains information about the error. Negative number: error as defined in the SCPI standard. Positive number: error that is specific to the R&S FPC.

<ErrorDescription> String containing a short error description.

Example: //Query complete error queue
 SYST:ERR:ALL?

Usage: Query only

SYSTem:ERRor:CODE:ALL?

This command queries the complete error queue.

The number of values depends on the length of the queue.

If the error queue is empty, the command returns 0, 'No error'.

Return values:

<ErrorNumber> Number that contains information about the error. Negative number: error as defined in the SCPI standard. Positive number: error that is specific to the R&S FPC.

Example: //Query complete error queue
 SYST:ERR:CODE:ALL?

Usage: Query only

SYSTem:ERRor:CODE[:NEXT]?

This command queries the code of the next error in the error queue.

If the error queue is empty, the command returns 0.

Return values:

<ErrorNumber> Number that contains information about the error. Negative number: error as defined in the SCPI standard. Positive number: error that is specific to the R&S FPC.

Example: //Query the code of the next error
 STAT:ERR:CODE?

Usage: Query only

SYSTem:ERRor:COUNT?

This command queries the number of errors currently in the error queue.

Return values:

<NumErrors> <numeric value>

Example: //Query the number of errors in the error queue
 SYST:ERR:COUN?

Usage: Query only

SYSTem:ERRor[:NEXT]?

This command queries the oldest entry in the error queue and deletes it.

If the error queue is empty, the command returns 0, 'No error'.

Return values:

<ErrorNumber> Number that contains information about the error. Negative number: error as defined in the SCPI standard. Positive number: error that is specific to the R&S FPC.

<ErrorDescription> String containing a short error description.

Example: //Query error queue
 STAT:ERR?

Usage: Query only

SYSTem:HELP:HEADers?

This command returns a list of all available remote control commands.

Return values:

<Commands> String containing all available remote control commands.

Example: //Return the syntax of all available commands
 SYST:HELP:HEAD?

Usage: Query only

SYSTem:HELP:SYNTax?

This command returns the full syntax of the specified command.

Return values:

<Command> String containing the command you want to query.

Example: //Return the full syntax. In this case: 'SYSTem:ERRor[:NEXT]'.
 SYST:HELP:SYNT? 'SYST:ERR?'

Usage: Query only

SYSTem:LANGUage <Language>

This command selects the language of the user interface.

You can query a list of available languages with `SYSTem:LANGUage:CATalog?`

Parameters:

<Language> String containing the language.

Example: //Select the language
 SYST:LANG 'english'

Manual operation: See "[Regional](#)" on page 356

SYSTem:LANGUage:CATalog?

This command queries the available user interface languages.

Return values:

<Languages> All available languages.

Example: //Query all available languages
 SYST:LANG:CAT?

Usage: Query only

Manual operation: See "[Regional](#)" on page 356

SYSTem:MEMory:FREE?**SYSTem:MEMory:TOTal?****SYSTem:STORe:USED?**

These command query the current state of the storage memory.

- `SYSTem:STORe:FREE:` Queries how much memory is available.
- `SYSTem:STORe:TOTal:` Queries the size of the memory.
- `SYSTem:STORe:USED:` Queries how much memory is currently used.

Return values:

<MemorySize> <numeric value>

Example: //Query total size of storage memory
 SYST:STOR:TOT?

Usage: Query only

SYSTem:STORe:FREE?**SYSTem:STORe:TOTal?****SYSTem:MEMory:USED?**

These command query the current state of the RAM.

- `SYSTem:MEMory:FREE:` Queries how much memory is available.
- `SYSTem:MEMory:TOTal:` Queries the size of the memory.

- `SYSTem:MEMory:USED:` Queries how much memory is currently used.

Return values:

<MemorySize> <numeric value>

Example: //Query free RAM
 `SYST:MEM:FREE?`

Usage: Query only

SYSTem:TIME <Hour>, <Minutes>, <Seconds>

This command defines the time of the internal clock.

Parameters:

<Hour> <numeric value> (integer)
 Range: 0 to 23

<Minutes> <numeric value> (integer)
 Range: 0 to 59

<Seconds> <numeric value> (integer)
 Range: 0 to 59

Example: //Change system time
 `SYST:TIME 12,30,30`

Manual operation: See ["Date and Time"](#) on page 356

SYSTem:TZONee <Hour>, <Minutes>

This command defines a shift of the system time to select another time zone.

Parameters:

<Hour> <numeric value> (integer)
 Range: 0 to 23
 *RST: 0

<Minutes> <numeric value> (integer)
 Range: 0 to 59
 *RST: 0

Example: //Shift the time one hour ahead
 `SYST:TZON 01,00`

Manual operation: See ["Date and Time"](#) on page 356

UNIT<n>:LENGth <Unit>

This command selects the unit for distances.

Suffix:

<n> irrelevant

Parameters:
 <Unit> **FEET**
 Length units in feet.
 METers
 Length units in meter.
 *RST: METers

Example: //Select length unit
 UNIT:LENG MET

19.6 Display Settings

DISPlay:BRIGhtness.....	215
SYSTem:DISPlay:UPDate[:STATe].....	215

DISPlay:BRIGhtness <Brightness>

This command defines the brightness of the display backlight.

Parameters:
 <Brightness> <numeric value>
 Range: 0 to 1
 *RST: 1 (100 %)

Example: //Define display brightness
 DISP:BRIG 0.80

Manual operation: See "Display" on page 356

SYSTem:DISPlay:UPDate[:STATe] <State>

This command turns the display during remote operation of the R&S FPC on and off.

Parameters:
 <State> ON | OFF | 1 | 0
 *RST: ON

Example: //Turn off display during remote operation
 SYST:DISP:UPD OFF

19.7 Audio Settings

SYSTem:BEEPer:KEY:VOLume.....	216
SYSTem:BEEPer:POVerload[:STATe].....	216
SYSTem:BEEPer:VOLume.....	216

SYSTem:BEEPer:KEY:VOLume <Volume>

This command defines the volume of the keyboard click sound.

Parameters:

<Volume> <numeric value>
 Range: 0 to 1
 *RST: 0.3 (30%)

Example: //Select the key click volume
 SYST:BEEP:KEY:VOL 0.10

Manual operation: See "Audio" on page 356

SYSTem:BEEPer:POVerload[:STATe] <State>

This command turns an alert on a power overload on and off.

You can define the volume of this sound with [SYSTem:BEEPer:VOLume](#).

Parameters:

<State> **ON | 1**
 An overload situation on one of the inputs produces a sound.
OFF | 0
 An overload produces no sound.
 *RST: OFF

Example: //Turn on audio output in case of overload
 SYST:BEEP:POV ON

Manual operation: See "Audio" on page 356

SYSTem:BEEPer:VOLume <Volume>

This command defines the volume of the system beeper.

Parameters:

<Volume> <numeric value>
 Range: 0 to 1
 *RST: 0.6 (60%)

Example: //Define the volume of the system beeper
 SYST:BEEP:VOL 0.50

Manual operation: See "Audio" on page 356

19.8 Data Management

DISPlay<n>[:WINDow]:FETCh?	217
HCOPy:DEVice:LANGuage	217
HCOPy[:IMMEDIATE]	218

MMEemory:CATalog?.....	218
MMEemory:CATalog:DIRectories?.....	218
MMEemory:CDIRectory.....	219
MMEemory:COpy.....	219
MMEemory:DATA.....	219
MMEemory:DELeTe.....	220
MMEemory:FILE.....	221
MMEemory:FILE:DATE.....	221
MMEemory:FILE:TIME.....	222
MMEemory:LOAD:STATe.....	222
MMEemory:MDIRectory.....	223
MMEemory:MOVE.....	223
MMEemory:NAME.....	224
MMEemory:RDIRectory.....	224
MMEemory:STORe:STATe.....	224
SYSTem:SET?.....	225
SYSTem:SET:DISPlay?.....	225
SYSTem:SET:LOCK.....	225
SYSTem:SET:UNLock.....	225

DISPlay<n>[:WINDow]:FETCh?

This command takes a screenshot of the current screen content and returns it as a jpg in binary format.

Suffix:

<n> irrelevant

Return values:

<Data> <numeric value>
Screenshot in binary data.

Example: //Query screenshot
DISP:FETC?

Usage: Query only

HCOPy:DEVice:LANGUage <Format>

This command selects the file format for screenshots.

Parameters:

<Format> PNG | JPG

Example: //Select the png format for screenshots
HCOP:DEV:LANG PNG

Manual operation: See "[Capture](#)" on page 357

HCOPy[:IMMEDIATE]

This command takes a screenshot of the current display contents and stores it on the R&S FPC internal memory.

Prerequisites for this command

- Define a file name for the screenshot (**MMEMory:NAME**).

Example: //Make and store a screenshot of the current screen in a file 'Test.png'.
 HCOP:DEV:LANG PNG
 MMEM:NAME '\Public\funny\screenshot.png'
 HCOP

Usage: Event

MMEMory:CATalog?

This command queries the files that are in the currently selected directory.

You can select a directory with **MMEMory:CDIRectory**

Return values:

<Files> String containing following information:
 <UsedDiskSpace>,<FreeDiskSpace>,<FileName_1>,<Size-File_1>,<ModificationDateFile_1>,<ModificationTime-File_1>,...,<FileName_n>,<SizeFile_n>,<ModificationDate-File_n>,<ModificationTimeFile_n>

Example: //Open directory 'Limit Lines'
 MMEM:CDIR '\Public\Limit Lines'
 //Return all files in "\Public\Limit Lines"
 MMEM:CAT?

Usage: Query only

Manual operation: See "[File Manager](#)" on page 359

MMEMory:CATalog:DIRectories?

This command queries the directories that are in the currently selected directory.

You can select a directory with **MMEMory:CDIRectory**

Return values:

<Directories> String containing following information:
 <UsedMemory>,<FreeMemory>,<DirName_1>,<ModificationDateDir_1>,<ModificationTimeDir_1>,...,<DirName_n>,<ModificationDateDir_n>,<ModificationTimeDir_n>

Example: //Open directory \Public.
 MMEM:CDIR '\Public'
 //Return all directories in the \Public directory
 MMEM:CAT:DIR?

Usage: Query only
Manual operation: See ["File Manager"](#) on page 359

MMEMory:CDIRectory <PathName>

This command changes the current directory.

Parameters:

<PathName> String containing the path to the destination directory. The path and file name comply with Windows conventions. Note that the folder references in the string are case-sensitive.

Example: //Open directory "\\Public".
 MMEM:CDIR '\\Public'

Manual operation: See ["File Manager"](#) on page 359

MMEMory:COPY <SourceFile>, <Destination>

This command copies a file to another directory.

Setting parameters:

<SourceFile> String containing the path and name of the file, including the file-name extension. The path and file name comply with Windows conventions. Note that the folder and filename references in the string are case-sensitive.

<Destination> String containing the path and name of the file, including the file-name extension. If a file the same name already exists in the destination folder, the command will return an error message. The path and file name comply with Windows conventions. Note that the folder and filename references in the string are case-sensitive.

Example: //Copy a file
 MMEM:COPY '\\Public\\result.set',
 '\\Public\\funny\\result.set'

Usage: Setting only

Manual operation: See ["File Manager"](#) on page 359

MMEMory:DATA <FileName>[, <BlockData>]

This command writes block data into a file. The delimiter must be set to EOI to obtain error-free data transfer.

When you query the contents of a file, you can save them in a file on the remote control computer.

The command is useful for reading stored settings files or trace data from the instrument or for transferring them to the instrument.

Prerequisites for this command

- Create an empty file (`MMEMoRY:NAME`).

Parameters:

<FileName> String containing the path and name of the file, including the file-name extension.
The path and file name comply with Windows conventions. Note that the folder and filename references in the string are case-sensitive.

<BlockData> Data block with the following structure.

#
Hash sign.

<number>
Length of the length information.

<number>
Length information of the binary data (number of bytes).

<data>
Binary data with the indicated <number> of bytes.

Example:

```
//Create a new file called 'Testfile.txt'
MMEM:NAME '\Public\funny\Testfile.txt'
//Write block data
MMEM:DATA
'\Public\User\Testfile.txt',#20Contents of the
file
//Meaning of the parameters:
• '\Public\..' selects the target file
• #2: hash sign and length of the length information (20 bytes = 2
digits)
• 20: indicates the number of subsequent binary data bytes
• Contents of the file: store 20 binary bytes (characters) to the
file
//Transfer the contents of the file 'Testfile.txt' to the control com-
puter.
MMEM:DATA? '\Public\User\Testfile.txt'
```

Manual operation: See "[File Manager](#)" on page 359

MMEMoRY:DELeTe <File>

This command deletes a file.

Setting parameters:

<File> String containing the path and name of the file, including the file-name extension.
The path and file name comply with Windows conventions. Note that the folder and filename references in the string are case-sensitive.

Example: //Delete a file
 MMEM:DEL '\Public\funny\result.set'

Usage: Setting only

Manual operation: See "[File Manager](#)" on page 359

MMEMory:FILE <FileName>[, <BlockData>]

This command creates a file.

If you do not define the block data, the command creates an empty file. You can add block data later with [MMEMory:DATA](#).

Parameters:

<FileName> String containing the path and name of the file, including the file-name extension.
 The path and file name comply with Windows conventions. Note that the folder and filename references in the string are case-sensitive.

<BlockData> Data block with the following structure.

#
 Hash sign.

<number>
 Length of the length information.

<number>
 Length information of the binary data (number of bytes).

<data>
 Binary data with the indicated <number> of bytes.

Example: //Create a test file
 MMEM:FILE '\Public\funny\test.txt',#220Contents
 of the file

Manual operation: See "[File Manager](#)" on page 359

MMEMory:FILE:DATE <FileName>[, <Year>, <Month>, <Day>]

This command defines the date stamp of a file.

Parameters:

<FileName> String containing the path and name of the file, including the file-name extension.
 The path and file name comply with Windows conventions. Note that the folder and filename references in the string are case-sensitive.

<Year> <numeric value> (integer)
 Range: 2000 to 2107

<Month> <numeric value> (integer)

Range: 1 to 12

<Day> <numeric value> (integer)

Range: 1 to 31

Example: //Change date stamp of result.set file
 MMEM:FILE:TIME 1, '\Public\result.set',
 2006,04,01

MMEMory:FILE:TIME <FileName>[, <Hour>, <Minutes>, <Seconds>]

This command defines the time stamp of a file.

Parameters:

<FileName> String containing the path and name of the file, including the file-name extension.
 The path and file name comply with Windows conventions. Note that the folder and filename references in the string are case-sensitive.

<Hour> <numeric value> (integer)

Range: 0 to 23

<Minutes> <numeric value> (integer)

Range: 0 to 59

<Seconds> <numeric value> (integer)

Range: 0 to 59

Example: //Change time stamp of result.set file
 MMEM:FILE:TIME 1, '\Public\result.set',11,04,00

MMEMory:LOAD:STATe <1>, <FileName>

This command restores a dataset containing a previously saved measurement configuration.

Parameters:

<FileName> String containing the path and name of the file, including the file-name extension (.set).
 The path and file name comply with Windows conventions. Note that the folder references in the string are case-sensitive.

Setting parameters:

1 <numeric value>

Example: //Restore measurement configuration
 MMEM:LOAD:STAT 1, '\Public\result.set'

Usage: Setting only

Manual operation: See ["Recall"](#) on page 358
See ["Recall Screenshot"](#) on page 358
See ["File Manager"](#) on page 359

MMEMory:MDIRectory <Directory>

This command creates a directory.

Setting parameters:

<Directory> String containing the path and new directory name.
The path and file name comply with Windows conventions. Note that the folder references in the string are case-sensitive.

Example: //Create a new directory
MMEM:MDIR '\Public\funny'

Usage: Setting only

Manual operation: See ["File Manager"](#) on page 359

MMEMory:MOVE <SourceFile>, <Directory>

This command moves files to another directory.

At the same time, you can rename files with this command.

Parameters:

<Target> String containing the path and name of the destination file (if the path of source and destination folder are the same, but the file name is different, the command only renames the file).
The path and file name comply with Windows conventions. Note that the folder and filename references in the string are case-sensitive.

Setting parameters:

<SourceFile> String containing the path and file name of the source file, including the filename extension.
The path and file name comply with Windows conventions. Note that the folder and filename references in the string are case-sensitive.

Example: //Rename Screen0002.png to Screen0001.png
MMEM:MOVE '\Public\funny\test.png',
'\Public\funny\tested.png'
//Move file Screen0006.png to the 'Test' folder and rename the file Pic1.png
MMEM:MOVE '\Public\Screen
Shots\Screen0001.png', '\Public\Test\Pic1.png'

Usage: Setting only

Manual operation: See ["File Manager"](#) on page 359

MMEMory:NAME <FileName>

This command defines the path and file name of a screenshot.

You can take the actual screenshot with `HCOPY[:IMMEDIATE]`.

Parameters:

<FileName> String containing the path and name of the file, including the file-name extension (.png or .jpg).
The path and file name comply with Windows conventions. Note that the folder and filename references in the string are case-sensitive.

Example:

```
//Take a screenshot
MMEM:NAME 'Public\Screenshots\Test.png'
HCOP
```

Manual operation: See "[Capture](#)" on page 357

MMEMory:RDIRectory <Directory>

This command deletes the indicated directory.

Setting parameters:

<Directory> String containing the path and name of the directory you want to delete.
The path and folder name comply with Windows conventions. Note that the folder references in the string are case-sensitive.

Example:

```
//Delete a directory
MMEM:RDIR '\Public\funny'
```

Usage:

Setting only

Manual operation: See "[File Manager](#)" on page 359

MMEMory:STORe:STATe <1>, <TargetFile>

This command saves the current measurement configuration and results in a dataset.

Parameters:

<TargetFile> String containing the path and name of the destination file, including the filename extension (.set).
The path and file name comply with Windows conventions. Note that the folder and filename references in the string are case-sensitive.

Setting parameters:

1 <numeric value>

Example:

```
//Save the current measurement configuration
MMEM:STOR:STAT 1, '\Public\result.set'
```

Usage:

Setting only

Manual operation: See "Save" on page 358
See "File Manager" on page 359

SYSTem:SET?

This command queries the the contents of the currently active dataset and returns them in binary format.

Return values:

<Data> <block data>
Contents of the dataset in binary format.

Example: //Query current dataset
SYST:SET?

Usage: Query only

SYSTem:SET:DISPlay?

This command queries the the contents of the currently active dataset, including a screenshot of the current display contents, and returns them in binary format.

Return values:

<Data> <block data>
Contents of the dataset and a screenshot in binary format.

Example: //Query current dataset and screenshot
SYST:DISP:SET?

Usage: Query only

SYSTem:SET:LOCK <FileName>

This command adds write-protection to a file.

Parameters:

<FileName> String containing the path and name of the dataset.
The path and file name comply with Windows conventions. Note that the folder and filename references in the string are case-sensitive.

Example: //Write-protect a file
SYST:SET:LOCK '\Public\funny\result.set'

SYSTem:SET:UNLock <FileName>

This command removes write-protection from a dataset.

Parameters:

<FileName> String containing the path and name of the dataset.
The path and file name comply with Windows conventions. Note that the folder and filename references in the string are case-sensitive.

Example:

```
//Remove write-protection from a file
SYST:SET:UNL '\Public\funny\result.set'
```

19.9 Signal Source Configuration

SOURce:TG:AUTO.....	226
SOURce:TG:FREQuency.....	226
SOURce:TG:FREQuency:AUTO.....	227
SOURce:TG:POWer.....	227
SOURce:TG[:STATe].....	228

SOURce:TG:AUTO <State>

This command turns the tracking generator on and off.

Prerequisites for this command

- Turn on signal source (SOURce:TG[:STATe]).
- Select a span > 0.
Using the tracking generator is not possible for time domain measurements (span = 0). For time domain measurements, you have to turn off the tracking generator and either generate a signal whose frequency is fix or is coupled to the center frequency.
 - Fixed frequency: SOURce:TG:FREQuency
 - Coupled to center frequency: SOURce:TG:FREQuency:AUTO

Parameters:

<State>

ON | 1

Turns on the tracking generator. The R&S FPC generates a signal whose frequency depends on the current measurement frequency (signal source mode "Tracking Generator").

OFF | 0

Turns off the tracking generator. You can either generate a signal whose frequency is fix or is coupled to the center frequency.

Example:

```
//Turn on tracking generator
SOUR:TG ON
SOUR:TG:AUTO OFF
```

Manual operation: See "[Tracking Generator](#)" on page 367

SOURce:TG:FREQuency <Frequency>

This command defines the frequency of the signal generated by the signal source.

Prerequisites for this command

- Turn on signal source (`SOURce: TG[:STATe]`).

Parameters:

<Level> <numeric level>
 *RST: 0
 Default unit: dBm

Example: //Define signal source output power
 SOUR: TG ON
 SOUR: TG: POW -10DBM

Manual operation: See "Level" on page 367

SOURce:TG[:STATe] <State>

This command turns the signal source on and off.

Parameters:

<State> ON | OFF | 1 | 0
 Configure the frequency characteristics of the output signal with
 one of the following commands.
 • CW signal: `SOURce: TG: FREQuency: AUTO`
 • Tracking generator: `SOURce: TG: AUTO`
 Configure the output level with `SOURce: TG: POWer`.
 *RST: OFF

Example: //Turn on signal source
 SOUR: TG ON

Manual operation: See "Off" on page 367

19.10 Calibration

<code>CALibration<n>:ABORT</code>	228
<code>CALibration<n>:CONTINUE?</code>	229
<code>CALibration<n>:MODE?</code>	229
<code>CALibration<n>:START?</code>	230
<code>CALibration<n>:STATUS?</code>	231
<code>SYSTem:PRESet:CALibration:DISCard</code>	231

CALibration<n>:ABORT

This command aborts calibration.

Suffix:

<n> irrelevant

Example: //Abort calibration
CAL:STAR? S11C
'Connect Open to Port 1'
CAL:ABOR

Usage: Event

Manual operation: See "[Calibrate](#)" on page 397

CALibration<n>:CONTinue?

This command resumes calibration after a calibration standard has been connected.

Suffix:
<n> irrelevant

Return values:
<Instructions> String containing the instructions for the next calibration step.
You can find a list possible instructions in the table below.

Example: //Resume calibration
CAL:STAR? S11C
'Connect Open to Port 1'
//Connect Open
CAL:CONT?
'Connect Short to Port 1'

Usage: Query only

Manual operation: See "[Calibrate](#)" on page 397

Table 19-6: Return values: Possible instructions for calibration

'Connect Open to Port 1'	Connect the open to port 1 before resuming calibration.
'Connect Short to Port 1'	Connect the short to port 1 before resuming calibration.
'Connect Load to Port 1'	Connect the load to port 1 before resuming calibration.
'Connect Through'	Connect a through to ports 1 and 2.
'Disconnect DUT from port 1'	
'Calibration Done'	Calibration has been finished. No further actions required.

CALibration<n>:MODE?

This command queries the current calibration type.

Suffix:
<n> irrelevant

Return values:
<State> **0**
Not calibrated or default calibration.
1
User calibration.

Example: //Query calibration type
CAL:MODE?

Usage: Query only

Manual operation: See "[Calibrate](#)" on page 397

CALibration<n>:START? <CalibrationMethod>

This command selects a calibration method and initiates calibration.

After the command has been sent, it returns instructions on what to do to continue the calibration process and finish it successfully.

Suffix:
<n> irrelevant

Parameters for setting and query:

<CalibrationMethod> **S11Cal**
Full 1-port calibration.
Unavailable for S21 transmission measurements.

S11easy
Easy 1-port calibration.
Unavailable for S21 transmission measurements.

S21Norm
Normalization for S21.
Available for S21 transmission measurements.

Return values:
<Instructions> String containing the instructions for the next calibration step.
You can find a list possible instructions in the table below.

Example: //Start full 1-port calibration
MEAS:MODE REFL
CAL:STAR? S11C
//would return the instruction
'Connect Open to Port 1'

Usage: Query only

Manual operation: See "[Normalize S21](#)" on page 367
See "[Calibrate](#)" on page 397

Table 19-7: Return values: Possible instructions for calibration

'Connect Open to Port 1'	Connect the open to port 1 before resuming calibration.
'Connect Short to Port 1'	Connect the short to port 1 before resuming calibration.
'Connect Load to Port 1'	Connect the load to port 1 before resuming calibration.
'Connect Through'	Connect a through to ports 1 and 2.
'Disconnect DUT from port 1'	
'Calibration Done'	Calibration has been finished. No further actions required.

CALibration<n>:STATus?

This command queries calibration status for the current measurement.

Suffix:

<n> irrelevant

Return values:

<Status> String containing the calibration status.

NORMalized

Default calibration or user calibration is active.

APPRoximated

Approximate calibration. Measurement uncertainty must be anticipated.

Example:

```
//Query calibration status
CAL:STAT?
```

Usage:

Query only

Manual operation: See "[Calibrate](#)" on page 397

SYSTem:PRESet:CALibration:DISCard <State>

This command turns the mechanism that discards or keeps user calibration after a preset on and off.

Parameters:

<State> ON | OFF | 1 | 0
*RST: ON

Example:

```
//Discard correction values after preset
SYST:PRESet:CAL:DISC ON
```

Manual operation: See "[Preset Key](#)" on page 357

19.11 Applications

[INSTrument\[:SElect\]](#).....231

INSTrument[:SElect] <Application>

This command selects the measurement application.

Parameters:

<Application>

ADEMod

Selects the analog demodulation application.

DDEMod

Selects the digital demodulation application.

NAN

Select the vector network analyzer application.

RECeiver

Selects the receiver application.

SPECtrum

Selects the spectrum application.

Example:

```
//Select spectrum application
INST SAN
```

Manual operation:

See "Spectrum" on page 359

See "Analog Demod" on page 359

See "Digital Demod" on page 359

See "Receiver" on page 359

See "Vector Network Analyzer" on page 360

19.12 Remote Commands of the Spectrum Application

• Measurements and Result Displays	232
• Frequency	245
• Amplitude	252
• Bandwidth	259
• Sweep Control	261
• Trigger	264
• Traces	265
• Marker	271
• Marker Functions	282
• Display Lines	288
• Limit Lines	289

19.12.1 Measurements and Result Displays

The following commands are required for power measurements.

Note that the spectrogram result display does not support remote control.

• Power Measurements	233
• Channel Power	237
• Third Order Intermodulation	238
• Occupied Bandwidth	240
• TDMA Power	241
• Harmonic Distortion	241
• AM Modulation Depth	244

19.12.1.1 Power Measurements

The following commands are available for all power measurements (channel power, occupied bandwidth etc.)

<code>CALCulate<n>:MARKer<m>:FUNction:LEVel:ONCE</code>	233
<code>CALCulate<n>:MARKer<m>:FUNction:POWer:PRESet</code>	233
<code>CALCulate<n>:MARKer<m>:FUNction:POWer:PRESet:CHECK?</code>	234
<code>CALCulate<n>:MARKer<m>:FUNction:POWer:RESult?</code>	234
<code>CALCulate<n>:MARKer<m>:FUNction:POWer:SElect</code>	235
<code>CALCulate<n>:MARKer<m>:FUNction:POWer[:STATe]</code>	236

`CALCulate<n>:MARKer<m>:FUNction:LEVel:ONCE`

This command adjusts the reference level to the measured signal power.

This automatic routine makes sure that the signal power level does not overload the R&S FPC or limit the dynamic range by a too small S/N ratio.

To determine the best reference level, the R&S FPC aborts current measurements and performs a series of test sweeps. After it has finished the test, it continues with the actual measurement.

Prerequisites for this command

- Select and perform a power measurement (`CALCulate<n>:MARKer<m>:FUNction:POWer:SElect`).

Suffix:

<n>, <m> irrelevant

Example:

```
//Adjust the reference level
CALC:MARK:FUNC:LEV:ONCE
```

Usage:

Event

Manual operation:

See "Level Adjust" on page 362
 See "Level Adjust" on page 365
 See "Level Adjust" on page 366

`CALCulate<n>:MARKer<m>:FUNction:POWer:PRESet <Standard>`

This command selects one of the telecommunications standards that you can use for power measurements.

The standard is in line with the specifications and includes parameters like weighting filter, channel bandwidth and spacing, resolution and video bandwidth, as well as detector and sweep time.

Prerequisites for this command

- Select a power measurement (`CALCulate<n>:MARKer<m>:FUNction:POWer:SElect`).

Suffix:

<n>, <m> irrelevant

Setting parameters:

<Standard> String containing the file name of the standard.
Make sure to use the correct file extension (for example `.chpstd` for channel power measurements or `.obwstd` for occupied bandwidth measurements).

Example:

```
//Select the 3GPP WCDMA standard for channel power measurements
CALC:MARK:FUNC:POW:PRES '3GPP WCDMA.chpstd'
```

Usage:

Setting only

Manual operation:

See "[Standard](#)" on page 362
See "[Standard](#)" on page 365
See "[Standard](#)" on page 366

CALCulate<n>:MARKer<m>:FUNction:POWer:PRESet:CHECK?

This command checks if the current power measurement settings comply to the settings defined in the currently selected standard.

Prerequisites for this command

- Select a telecommunications standard for power measurements ([CALCulate<n>:MARKer<m>:FUNction:POWer:PRESet](#)).

Note that the command only checks the parameters that are defined by the standard.

Suffix:

<n>, <m> irrelevant

Return values:

<State> **0**
R&S FPC settings violate a standard configuration.
1
R&S FPC settings comply with the standard.

Example:

```
//Query compliance to the standard currently in use
CALC:MARK:FUNC:POW:PRES '3GPP WCDMA.chpstd'
CALC:MARK:FUNC:POW:PRES:CHEC?
```

Usage:

Query only

CALCulate<n>:MARKer<m>:FUNction:POWer:RESult? <Measurement>

This command queries the results of power measurements.

To get a valid result, you have to perform a complete sweep with synchronization to the sweep end before reading out the result. This is only possible in single sweep mode.

Prerequisites for this command

- Select a power measurement ([CALCulate<n>:MARKer<m>:FUNction:POWer:SElect](#)).

For the harmonic distortion and AM modulation depth measurements, use the following commands to query results:

- `CALCulate<n>:MARKer<m>:FUNction:HARMonics:DISTortion?`
- `CALCulate<n>:MARKer<m>:FUNction:MDEPth:RESult?`

Suffix:

<n>, <m> irrelevant

Query parameters:

<Measurement>

Return values:

<Power> The return values depend on the power measurement.

CPOWer

Returns the results for channel power measurements.
The return value is the power of the channel. The unit depends on the scaling of the vertical axis:

- logarithmic scaling returns the power in the currently selected unit (see `UNIT<n>:POWer`)
- linear scaling returns the power in W

OBANdwidth | OBWidth

Returns the results for measurements of the occupied bandwidth.

The return value is the occupied bandwidth in Hz.

TDMA

Returns the results for TDMA power measurements.
The return value is the power of the signal. The unit depends on the scaling of the vertical axis:

- logarithmic scaling returns the power in the currently selected unit (see `UNIT<n>:POWer`).
- linear scaling returns the power in W.

Example:

```
//Select occupied bandwidth measurement
CALC:MARK:FUNC:POW:SEL OBW
CALC:MARK:FUNC:POW:PRES '3GPP WCDMA.obwstd'
//Turn on single sweep mode, perform a measurement and
query the results.
INIT:CONT OFF
INIT;*WAI
CALC:MARK:FUNC:POW:RES? OBW
```

Usage:

Query only

Manual operation:

See "[Channel Power](#)" on page 361
See "[TDMA Power](#)" on page 361
See "[Occupied Bandwidth](#)" on page 361

CALCulate<n>:MARKer<m>:FUNction:POWer:SElect <Measurement>

This command selects one of the available power measurements.

Note:

- To turn on the harmonic distortion measurement, use `CALCulate<n>:MARKer<m>:FUNCTION:HARMonics[:STATe]`.
- To turn on the AM modulation depth measurement, use `CALCulate<n>:MARKer<m>:FUNCTION:MDEPth[:STATe]`.

Suffix:

<n>, <m> irrelevant

Parameters:

<Measurement> **CPOWER**
Selects the channel power measurement.

OBANdwidth | OBWidth
Selects the occupied bandwidth measurement (OBW).

TDMA
Selects the TDMA power measurement.

Example:

```
//Select the channel power measurement
CALC:MARK:FUNC:POW:SEL CPOW
```

Manual operation:

See "[Channel Power](#)" on page 361
See "[TDMA Power](#)" on page 361
See "[Occupied Bandwidth](#)" on page 361

CALCulate<n>:MARKer<m>:FUNCTION:POWer[:STATe] <State>

This command turns a power measurement on and off.

Suffix:

<n>, <m> irrelevant

Parameters:

<State> **ON | 1**
Turns on the power measurement.

OFF | 0
Performs a basic spectrum measurement.

*RST: OFF | 0

Example:

```
//Turn on OBW measurement
CALC:MARK:FUNC:POW:SEL OBW
CALC:MARK:FUNC:POW ON
//Return to basic spectrum measurement
CALC:MARK:FUNC:POW OFF
```

Manual operation:

See "[Spectrum](#)" on page 360
See "[Channel Power](#)" on page 361
See "[TDMA Power](#)" on page 361
See "[Occupied Bandwidth](#)" on page 361

19.12.1.2 Channel Power

The following remote commands are exclusive to the channel power measurement.

CALCulate<n>:MARKer<m>:FUNction:CPOWER:BANDwidth.....	237
CALCulate<n>:MARKer<m>:FUNction:CPOWER:MODE.....	237
CALCulate<n>:MARKer<m>:FUNction:CPOWER:UNIT.....	238
CALCulate<n>:MARKer<m>:FUNction:POWER:RESult:PHZ.....	238

CALCulate<n>:MARKer<m>:FUNction:CPOWER:BANDwidth <Bandwidth>

This command defines the channel bandwidth for channel power measurements.

Prerequisites for this command

- Select the channel power measurement (`CALCulate<n>:MARKer<m>:FUNction:POWER:SElect`).

Suffix:

<n>, <m> irrelevant

Parameters:

<Bandwidth> <numeric value>
 *RST: 3.84 MHz
 Default unit: Hz

Example:

```
//Define the channel bandwidth
CALC:MARK:FUNC:CPOW:BAND 10MHZ
```

Manual operation: See "[Channel Bandwidth](#)" on page 362

CALCulate<n>:MARKer<m>:FUNction:CPOWER:MODE <DisplayMode>

This command selects the display mode for channel power measurements.

Prerequisites for this command

- Select the channel power measurement (`CALCulate<n>:MARKer<m>:FUNction:POWER:SElect`).

Suffix:

<n>, <m> irrelevant

Parameters:

<DisplayMode> **CLR**
 Display the currently measured value ("Clear / Write").
 MAX
 Display the highest measured value ("Max Hold").
 *RST: CLR

Example:

```
//Select clear/write trace mode
CALC:MARK:FUNC:CPOW:MODE CLR
```

Manual operation: See "[Power Display](#)" on page 362

CALCulate<n>:MARKer<m>:FUNction:CPOWer:UNIT <Unit>

This command selects the unit of the for channel power measurements.

Prerequisites for this command

- Select the channel power measurement (`CALCulate<n>:MARKer<m>:FUNction:POWer:SElect`).

Suffix:

<n> irrelevant

<m> [Marker](#)

Parameters:

<Unit> DBM | DBMV | DBUV | VOLT | WATT | V | W
*RST: DBM

Example: //Select the unit for the channel power
`CALC:MARK:FUNC:CPOW:UNIT DBM`

Manual operation: See "[Power Unit](#)" on page 362

CALCulate<n>:MARKer<m>:FUNction:POWer:RESult:PHZ <State>

This command turns the display of the channel power in a 1 Hz bandwidth on and off.

Prerequisites for this command

- Select the channel power measurement (`CALCulate<n>:MARKer<m>:FUNction:POWer:SElect`).

Suffix:

<n>, <m> irrelevant

Parameters:

<State> ON | OFF | 1 | 0
*RST: OFF | 0

Example: //Display the measured channel power in a 1 Hz bandwidth
`CALC:MARK:FUNC:POW:RES:PHZ ON`

Manual operation: See "[Power Display](#)" on page 362

19.12.1.3 Third Order Intermodulation

The following remote commands are exclusive to the occupied bandwidth measurement.

<code>CALCulate<n>:MARKer<m>:FUNction:TOI:RESult?</code>	238
<code>CALCulate<n>:MARKer<m>:FUNction:TOI:SEARchsignal</code>	239
<code>CALCulate<n>:MARKer<n>:FUNction:TOI[:STATE]</code>	239

CALCulate<n>:MARKer<m>:FUNction:TOI:RESult?

This command queries the result of the third order intermodulation measurement.

Prerequisites for this command

- Turn on TOI measurement (`CALCulate<n>:MARKer<n>:FUNction:TOI[:STATe]`).

Suffix:

<n>, <m> irrelevant

Return values:

<TOI> <numeric value>
 Default unit: dBm

Example:

```
//Query TOI result
CALC:MARK:FUNC:TOI ON
CALC:MARK:FUNC:TOI:SEAR
CALC:MARK:FUNC:TOI:RES?
```

Usage: Query only

Manual operation: See "[Marker <x>](#)" on page 363

CALCulate<n>:MARKer<m>:FUNction:TOI:SEARchsignal <Once>

This command searches for signals to determine the TOI.

Prerequisites for this command

- Turn on TOI measurement (`CALCulate<n>:MARKer<n>:FUNction:TOI[:STATe]`).

Suffix:

<n>, <m> irrelevant

Setting parameters:

<Once> ONCE

Example:

```
//Search for signals
CALC:MARK:FUNC:TOI ON
CALC:MARK:FUNC:TOI:SEAR
```

Usage: Setting only

Manual operation: See "[Search Signals](#)" on page 362

CALCulate<n>:MARKer<n>:FUNction:TOI[:STATe] <State>

This command turns the third order intermodulation measurement on and off.

Suffix:

<n>, <m> irrelevant

Parameters:

<State> **ON | 1**
Turns on the third order intermodulation measurement.

OFF | 0
Performs a basic spectrum measurement.

*RST: OFF

Example:

```
//Measure the TOI
CALC:MARK:FUNC:TOI ON
```

Manual operation: See "Third Order Intermod." on page 361

19.12.1.4 Occupied Bandwidth

The following remote commands are exclusive to the occupied bandwidth measurement.

CALCulate<n>:MARKer<m>:FUNction:OBW:BANDwidth.....	240
CALCulate<n>:MARKer<m>:FUNction:OBAN:BANDwidth.....	240
CALCulate<n>:MARKer<m>:FUNction:OBW:BANDwidth:PCT.....	240
CALCulate<n>:MARKer<m>:FUNction:OBAN:BANDwidth:PCT.....	240

CALCulate<n>:MARKer<m>:FUNction:OBW:BANDwidth <ChannelBW>
CALCulate<n>:MARKer<m>:FUNction:OBAN:BANDwidth <ChannelBW>

This command defines the channel bandwidth for occupied bandwidth measurements.

Prerequisites for this command

- Turn on occupied bandwidth measurement (CALCulate<n>:MARKer<m>:FUNction:POWer:SElect).

Suffix:

<n>, <m> irrelevant

Parameters:

<ChannelBW> <numeric value>

*RST: 3.84 MHz

Default unit: Hz

Example:

```
//Define a channel bandwidth
CALC:MARK:FUNC:OBW:BAND 1 MHZ
```

Manual operation: See "Channel Bandwidth" on page 366

CALCulate<n>:MARKer<m>:FUNction:OBW:BANDwidth:PCT <Percentage>
CALCulate<n>:MARKer<m>:FUNction:OBAN:BANDwidth:PCT <Percentage>

This command defines the percentage of the total power that defines the occupied bandwidth.

Suffix:

<n>, <m> irrelevant

Parameters:

<Percentage> <numeric value>
 Range: 10 to 99.9%
 *RST: 99%

Example:

```
//Define power percentage
CALC:MARK:FUNC:OBW:BAND:PCT 95
```

Manual operation: See "[% Power Bandwidth](#)" on page 367

19.12.1.5 TDMA Power

The following remote commands are exclusive to the TDMA power measurement.

Commands to configure TDMA power measurements described elsewhere.

- Sweep time:

```
[SENSe:]SWEep:TIME
```

[CALCulate<n>:MARKer<m>:FUNctio:n:TDMA:BURSt](#)..... 241

CALCulate<n>:MARKer<m>:FUNctio:n:TDMA:BURSt <BurstLength>

This command defines the burst length of the TDMA signal.

Prerequisites for this command

- Turn on TDMA power measurement ([CALCulate<n>:MARKer<m>:FUNctio:n:POWer:SElect](#)).

Suffix:

<n>, <m> irrelevant

Parameters:

<BurstLength> <numeric value>
 The value range depends on the current sweep time.
 *RST: 470 us
 Default unit: s

Example:

```
//Define the burst length
CALC:MARK:FUNC:TDMA:BURS 80 US
```

Manual operation: See "[Burst Length](#)" on page 365

19.12.1.6 Harmonic Distortion

The following remote commands are exclusive to the harmonic distortion measurement.

[CALCulate<n>:MARKer<m>:FUNctio:n:HARMonics:DISToRtion?](#)..... 242
[CALCulate<n>:MARKer<m>:FUNctio:n:HARMonics:LIST?](#)..... 242
[CALCulate<n>:MARKer<m>:FUNctio:n:HARMonics:NHARmonics](#)..... 243
[CALCulate<n>:MARKer<m>:FUNctio:n:HARMonics:PRESet](#)..... 243
[CALCulate<n>:MARKer<m>:FUNctio:n:HARMonics\[STATE\]](#)..... 244

CALCulate<n>:MARKer<m>:FUNction:HARMonics:DiSTortion? <ResultType>

This command queries the total harmonic distortion of the signal.

To get a valid result, you have to perform a complete sweep with synchronization to the sweep end between activating the delta marker and reading out the result. This is only possible in single sweep mode.

Prerequisites for this command

- Turn on the harmonic distortion measurement ([CALCulate<n>:MARKer<m>:FUNction:HARMonics\[:STATe\]](#) on page 244).

Suffix:

<n>, <m> irrelevant

Query parameters:

<ResultType> TOTal

Return values:

<THD> Pair of values, one showing the THD in %, one in dB.

Example:

See [CALCulate<n>:MARKer<m>:FUNction:HARMonics:PRESet](#)

Usage:

Query only

Manual operation: See "[Harmonics](#)" on page 365

CALCulate<n>:MARKer<m>:FUNction:HARMonics:LiST?

This command queries the position of the harmonics.

To get a valid result, you have to perform a complete sweep with synchronization to the sweep end between activating the delta marker and reading out the result. This is only possible in single sweep mode.

Prerequisites for this command

- Turn on the harmonic distortion measurement ([CALCulate<n>:MARKer<m>:FUNction:HARMonics\[:STATe\]](#) on page 244).

Suffix:

<n>, <m> irrelevant

Return values:

<Position> <numeric value>

Returns one value for every harmonic.

The first value is the absolute power of the first harmonic. The level unit depends on the unit you have set with the [UNIT<n>:POWer](#) command. The other values are power levels relative to the first harmonic. The unit for these is dB.

The total number of return values depends on the number of harmonics you have set with [CALCulate<n>:MARKer<m>:FUNction:HARMonics:NHARmonics](#)

Example: See `CALCulate<n>:MARKer<m>:FUNCTION:HARMonics:PRESet`

Usage: Query only

Manual operation: See "Harmonics" on page 365

CALCulate<n>:MARKer<m>:FUNCTION:HARMonics:NHARmonics <Harmonics>

This command defines the number of harmonics that are analyzed.

Prerequisites for this command

- Turn on the harmonic distortion measurement (`CALCulate<n>:MARKer<m>:FUNCTION:HARMonics[:STATe]` on page 244).

Suffix:

<n>, <m> irrelevant

Parameters:

<Harmonics> <numeric value> (integer)
 Range: 1 to 6
 *RST: 2

Example: See `CALCulate<n>:MARKer<m>:FUNCTION:HARMonics:PRESet`

Manual operation: See "Harmonics" on page 365

CALCulate<n>:MARKer<m>:FUNCTION:HARMonics:PRESet

This command optimizes the settings for the harmonic distortion measurement.

Prerequisites for this command

- Turn on the harmonic distortion measurement (`CALCulate<n>:MARKer<m>:FUNCTION:HARMonics[:STATe]` on page 244).

Suffix:

<n>, <m> irrelevant

Example:

```
//Activate the harmonic distortion measurement.
CALC:MARK:FUNC:HARM ON
//Set the number of harmonics to 4.
CALC:MARK:FUNC:HARM:NHAR 4
//Adjust the settings of the measurement.
CALC:MARK:FUNC:HARM:PRES
//Query the position of the harmonics and the total harmonic distortion.
CALC:MARK:FUNC:HARM:LIST?
CALC:MARK:FUNC:HARM:DIST? TOT
```

Usage: Event

Manual operation: See "Adjust Setting" on page 365

CALCulate<n>:MARKer<m>:FUNCTION:HARMonics[:STATe] <State>

This command turns the harmonic distortion measurement on and off.

Suffix:

<n>, <m> irrelevant

Parameters:

<State> **ON | 1**
Turns on the harmonic distortion measurement.

OFF | 0
Performs a basic spectrum measurement.

*RST: OFF

Example: See [CALCulate<n>:MARKer<m>:FUNCTION:HARMonics:PRESet](#)

Manual operation: See "[Harmonic Distortion](#)" on page 361

19.12.1.7 AM Modulation Depth

The following remote commands are exclusive to the AM Modulation depth measurement.

Commands to configure AM modulation depth measurements described elsewhere.

- Marker position on the x-axis (absolute):

[CALCulate<n>:MARKer<m>:X](#)

[CALCulate<n>:DELTaMarker<m>:X](#)

Notes:

- For the AM modulation depth measurement, 3 markers are automatically positioned on the trace: One marker on the assumed carrier, the other two on the sidebands.
- The position of (delta) marker 2 must be a value larger than the value of marker 1 (to the right of marker 1).
- When you move (delta) marker 2, (delta) marker 3 is automatically positioned on the opposite sideband to the left of marker 1. The distance relative to marker 1 for both (delta) markers 2 and 3 is the same.

- Marker position on the x-axis (relative):

[CALCulate<n>:DELTaMarker<m>:X:RELative](#)

[CALCulate<n>:MARKer<m>:FUNCTION:MDEPth:RESult?](#).....244

[CALCulate<n>:MARKer<m>:FUNCTION:MDEPth\[:STATe\]](#)..... 245

CALCulate<n>:MARKer<m>:FUNCTION:MDEPth:RESult?

This command queries the results of the AM modulation depth measurement.

To get a valid result, you have to perform a complete sweep with synchronization to the sweep end between activating the delta marker and reading out the result. This is only possible in single sweep mode.

Prerequisites for this command

- Turn on modulation depth measurement (`CALCulate<n>:MARKer<m>:FUNction:MDEPth[:STATe]`).

Suffix:

<n>, <m> irrelevant

Return values:

<ModulationDepth> <numeric value>
Modulation depth in %.

Example: //Query the AM modulation depth.
`CALC:MARK:FUNC:MDEP:RES?`

Usage: Query only

Manual operation: See "[Marker <x>](#)" on page 366

CALCulate<n>:MARKer<m>:FUNction:MDEPth[:STATe] <State>

This command turns the AM modulation depth measurement on and off.

Suffix:

<n>, <m> irrelevant

Parameters:

<State> **ON | 1**
Turns on the AM modulation depth measurement.
OFF | 0
Performs a basic spectrum measurement.
***RST: OFF**

Example: //Turn on AM modulation depth measurement
`CALC:MARK:FUNC:MDEP ON`

Manual operation: See "[AM Modulation Depth](#)" on page 361

19.12.2 Frequency

[SENSe:]CHANnel.....	246
[SENSe:]CHANnel:TABLE:SElect:DOWNlink.....	246
[SENSe:]CHANnel:TABLE:SElect:UPLink.....	246
[SENSe:]CHANnel:TABLE:SElect.....	247
[SENSe:]CHANnel:TABLE:SET.....	247
[SENSe:]FREQuency:CENTer.....	248
[SENSe:]FREQuency:CENTer:STEP.....	248
[SENSe:]FREQuency:CENTer:STEP:LINK.....	248
[SENSe:]FREQuency:INPut:MODE.....	249
[SENSe:]FREQuency:MODE.....	249
[SENSe:]FREQuency:OFFSet.....	250
[SENSe:]FREQuency:SPAN.....	250

[SENSe:]FREQuency:SPAN:FULL.....	251
[SENSe:]FREQuency:START.....	251
[SENSe:]FREQuency:STOP.....	251

[SENSe:]CHANnel <ChannelNumber>

This command selects the channel to be analyzed.

Prerequisites for this command

- Select channel table frequency mode ([SENSe:]FREQuency:INPut:MODE).

Parameters:

<ChannelNumber> <numeric value> (integer only)
 *RST: depends on the channel table

Example: See [SENSe:]CHANnel:TABLE:SElect

Manual operation: See "Frequency Mode" on page 368
 See "Frequency Mode" on page 379

[SENSe:]CHANnel:TABLE:SElect:DOWNlink <ChannelTable>

This command selects a channel table configured for downlink signals.

Prerequisites for this command

- Select downlink mode ([SENSe:]CHANnel:TABLE:SET).

Parameters:

<ChannelTable> String containing the name of the channel table.
 *RST: ''

Example: See [SENSe:]CHANnel:TABLE:SElect

Manual operation: See "Frequency Mode" on page 368
 See "Signal Standard" on page 398

[SENSe:]CHANnel:TABLE:SElect:UPLink <ChannelTable>

This command selects a channel table configured for uplink signals.

Prerequisites for this command

- Select uplink mode ([SENSe:]CHANnel:TABLE:SET).

Parameters:

<ChannelTable> String containing the name of the channel table.
 *RST: ''

Example: See [SENSe:]CHANnel:TABLE:SElect

Manual operation: See "Frequency Mode" on page 368
 See "Signal Standard" on page 398

[SENSe:]CHANnel:TABLE:SElect <ChannelTable>

This command selects a channel table configured for the link direction you have selected with `[SENSe:]CHANnel:TABLE:SET`.

Note that if you have previously selected a channel table with `[SENSe:]CHANnel:TABLE:SElect:DOWNlink` or `[SENSe:]CHANnel:TABLE:SElect:UPLink`, this command replaces that file.

Parameters:

<ChannelTable> String containing the file name of the channel table.
*RST: ''

Example:

```
//Select channel table selection for uplink signals.
CHAN:TABL:SET UP
//Load the channel table with the name 'TV China' for the uplink.
CHAN:TABL:SEL '\Public\Channel Tables\TV\TV
China.chntab'
//Both following commands replace the uplink channel table 'TV
China' with 'TV Italy'.
CHAN:TABL:SEL '\Public\Channel Tables\TV\TV
Italy.chntab'
or
CHAN:TABL:SEL:UPL '\Public\Channel Tables\TV\TV
Italy.chntab'
//Downlink channel tables are not affected by the commands
sent so far.
//Select a particular uplink channel (e.g. #10) instead of a (center)
frequency.
FREQ:INP:MODE CHAN
CHAN 10
//To select an additional downlink channel table, use either:
CHAN:TABL:SET DOWN
CHAN:TABL:SEL '\Public\Channel Tables\TV\TV
Italy.chntab'
or
CHAN:TABL:SEL:DOWN '\Public\Channel
Tables\TV\TV Italy.chntab'
```

[SENSe:]CHANnel:TABLE:SET <Direction>

This command selects the link direction for measurements with channel tables.

Parameters:

<Direction> **DOWN**
Selects the downlink.
UP
Selects the uplink.
*RST: UP

Example: See `[SENSe:]CHANnel:TABLE:SElect`

[SENSe:]FREQuency:CENTer <Frequency>

This command defines the center frequency of the R&S FPC.

In the spectrum application, the command also defines the frequency for time domain measurements (span = 0).

Parameters:

<Frequency> <numeric value>

Refer to the datasheet for details on the frequency range of your R&S FPC.

*RST: fmax/2 with fmax = maximum frequency

Default unit: Hz

Example: //Define center frequency
 FREQ:CENT 100MHZ

Manual operation: See "[Center Frequency](#)" on page 368
 See "[Center Frequency](#)" on page 388
 See "[Center Frequency](#)" on page 392
 See "[Center Frequency](#)" on page 398

[SENSe:]FREQuency:CENTer:STEP <StepSize>

This command defines the center frequency step size.

Prerequisites for this command

- Turn off step size coupling ([[SENSe:\]FREQuency:CENTer:STEP:LINK](#)).

Parameters:

<StepSize> <numeric value>

Range: 1 Hz to fmax

*RST: – (AUTO 0.1*SPAN is switched on)

Default unit: Hz

Example: //Define a CF step size
 FREQ:CENT:STEP:LINK OFF
 FREQ:CENT:STEP 10MHZ

Manual operation: See "[Center Freq Step Size](#)" on page 368
 See "[Frequency Step](#)" on page 379
 See "[Center Freq Step Size](#)" on page 388
 See "[Center Freq Step Size](#)" on page 393

[SENSe:]FREQuency:CENTer:STEP:LINK <StepSizeCoupling>

This command selects the center frequency step size mode.

For time domain measurements, the command couples the step size to the resolution bandwidth.

Parameters:**<StepSizeCoupling> CENTER**

Step size equals the current center frequency.

DIVTen

Couple the step size to the span (10 %).

OFF

Turn off the coupling (manual step size).

You can define a manual step size with `[SENSe:]FREQuency:CENTer:STEP`.***RST: DIVTen****Example:**

```
//Couple the step size to the span
FREQ:CENT:STEP:LINK DIVT
```

Manual operation: See "[Center Freq Step Size](#)" on page 368**[SENSe:]FREQuency:INPut:MODE <InputMode>**

This command selects the frequency input mode. Select the channel frequency mode only if you want to work with channel tables. In this case, the input of the center frequency is not a frequency value, but a channel number.

Parameters:**<InputMode>****FREQuency**

Center frequency is defined in terms of a frequency (in Hz).

You can define the frequency with `[SENSe:]FREQuency:CENTer`.**CHANnel**

Center frequency is defined in terms of a channel.

You can select the channel with `[SENSe:]CHANnel`.***RST: FREQ****Example:**

```
//Set the frequency mode to work with channel tables
FREQ:INP:MODE CHAN
```

Manual operation: See "[Frequency Mode](#)" on page 368
 See "[Frequency Mode](#)" on page 379
 See "[Signal Standard](#)" on page 398

[SENSe:]FREQuency:MODE <OperationMode>

This command selects the measurement domain (frequency or time).

In the time domain (CW and FIXed), set the frequency with:

- `[SENSe:]FREQuency:CENTer`

In the frequency domain (SWEep), set it with:

- `[SENSe:]FREQuency:CENTer`
- `[SENSe:]FREQuency:SPAN`

- `[SENSe:]FREQuency:START`
- `[SENSe:]FREQuency:STOP`

Parameters:

<OperationMode> **CW**
 Select the time domain (span = 0)

FIXed
 Select the time domain (span = 0)

SWEep
 Select the frequency domain (span > 0).

*RST: SWEep

Example: //Activate frequency domain measurements
`FREQ:MODE SWE`

Manual operation: See "[Frequency Mode](#)" on page 368

[SENSe:]FREQuency:OFFSet <FrequencyOffset>

This command defines a frequency offset.

Parameters:

<FrequencyOffset> <numeric value>

Range: depends on the start frequency to 100 GHz

*RST: 0 Hz

Default unit: Hz

Example: //Define a frequency offset
`FREQ:OFFS 100MHZ`

Manual operation: See "[Frequency Offset](#)" on page 368
 See "[Frequency Offset](#)" on page 393

**[SENSe:]FREQuency:SPAN **

This command defines the frequency span.

If you define a span of 0 Hz, the R&S FPC starts a measurement in the time domain.

Parameters:

 <numeric value>

Refer to the datasheet for details on the frequency range of your R&S FPC.

*RST: fmax with fmax = maximum frequency

Default unit: Hz

Example: //Define frequency span
`FREQ:SPAN 10MHZ`

Manual operation: See "[Manual Span](#)" on page 369
 See "[Zero Span](#)" on page 369
 See "[Manual Span](#)" on page 399

[SENSe:]FREQuency:SPAN:FULL

This command restores the full span.

Refer to the datasheet for details on the frequency range of your R&S FPC.

Example: //Restore full span
FREQ:SPAN:FULL

Usage: Event

Manual operation: See "[Full Span](#)" on page 369
See "[Full Span](#)" on page 399

[SENSe:]FREQuency:STARt <Frequency>

This command defines the start frequency for measurements in the frequency domain (span > 0).

Parameters:

<Frequency> <numeric value>

Refer to the datasheet for details on the frequency range of your R&S FPC.

*RST: 0 Hz

Default unit: Hz

Example: //Define start frequency
FREQ:STAR 20MHZ

Manual operation: See "[Start Frequency](#)" on page 368
See "[Start Frequency](#)" on page 398

[SENSe:]FREQuency:STOP <Frequency>

This command defines the stop frequency for measurements in the frequency domain (span > 0).

Parameters:

<Frequency> <numeric value>

Refer to the datasheet for details on the frequency range of your R&S FPC.

*RST: fmax

Default unit: Hz

Example: //Define stop frequency
FREQ:STOP 500MHZ

Manual operation: See "[Stop Frequency](#)" on page 368
See "[Stop Frequency](#)" on page 398

19.12.3 Amplitude

DISPlay<n>[:WINDow]:TRACe<t>:Y:SPACing.....	252
DISPlay<n>[:WINDow]:TRACe<t>:Y[:SCALe].....	252
DISPlay<n>[:WINDow]:TRACe<t>:Y[:SCALe]:ADJust.....	253
DISPlay<n>[:WINDow]:TRACe<t>:Y[:SCALe]:RLEVel.....	253
DISPlay<n>[:WINDow]:TRACe<t>:Y[:SCALe]:RLEVel:OFFSet.....	254
DISPlay<n>[:WINDow]:TRACe<t>:Y[:SCALe]:RPOStion.....	254
INPut:ATTenuation.....	255
INPut:ATTenuation:AUTO.....	255
INPut:ATTenuation:MODE.....	256
INPut:GAIN:STATe.....	256
INPut:IMPedance.....	256
INPut:IMPedance:PAD.....	257
[SENSe:]CORRection:TRANsducer<td>:SELect.....	257
[SENSe:]CORRection:TRANsducer<td>:UNIT?.....	258
[SENSe:]CORRection:TRANsducer<td>[:STATe].....	258
UNIT<n>:POWER.....	258

DISPlay<n>[:WINDow]:TRACe<t>:Y:SPACing <Scaling>

This command selects the scale of the y-axis.

Suffix:

<n>	irrelevant
<t>	irrelevant

Parameters:

<Scaling>

LOGarithmic

Select a logarithmic scale.

When you select a logarithmic scale, you can define the display range manually or automatically.

- Manual: `DISPlay<n>[:WINDow]:TRACe<t>:Y[:SCALe]`
- Automatic: `DISPlay<n>[:WINDow]:TRACe<t>:Y[:SCALe]:ADJust`

LINear

Select a linear scale (%).

The display range of a linear scale is fixed (0 % to 100 %).

*RST: LOGarithmic

Example:

```
//Select linear scaling of the y-axis
DISP:TRAC:Y:SPAC LIN
```

Manual operation:

See "Range / Ref Position" on page 370
See "Range / Ref Position" on page 380

DISPlay<n>[:WINDow]:TRACe<t>:Y[:SCALe] <DisplayRange>

This command defines the display range of the y-axis.

Prerequisites for this command

- Select logarithmic scale for the y-axis (`DISPlay<n>[:WINDow]:TRACe<t>:Y:SPACing`).
For a linear scale, you cannot modify the display range as it is fixed.

Suffix:

<n> irrelevant
<t> irrelevant

Parameters:

<DisplayRange> <numeric value>
Range: 1 to 150 dB
*RST: 100 dB
Default unit: dB

Example:

```
//Define display range
DISP:TRAC:Y:SPAC LOG
DISP:TRAC:Y 110dB
```

Manual operation: See "[Range / Ref Position](#)" on page 370
See "[Range / Ref Position](#)" on page 380

DISPlay<n>[:WINDow]:TRACe<t>:Y[:SCALe]:ADJust

This command automatically scales the y-axis.

Suffix:

<n> irrelevant
<t> irrelevant

Example:

```
//Adjust the y-axis
DISP:TRAC:Y:ADJ
```

Usage:

Event

Manual operation: See "[Range / Ref Position](#)" on page 370
See "[Auto Range](#)" on page 370
See "[Range / Ref Position](#)" on page 380
See "[Auto Range](#)" on page 380
See "[Auto Range](#)" on page 400

DISPlay<n>[:WINDow]:TRACe<t>:Y[:SCALe]:RLEVel <ReferenceLevel>

This command defines the reference level.

Suffix:

<n> irrelevant
<t> irrelevant

Parameters:

<ReferenceLevel> <numeric value>

The unit depends on `UNIT<n>:POWer`.

The available value range is specified in the data sheet.

*RST: -20 dBm

Example:

```
//Define reference level
UNIT:POW DBM
DISP:TRAC:Y:RLEV -60
```

Manual operation:

See "Reference Level" on page 370

See "Reference Level" on page 380

See "Reference Level" on page 388

See "Reference Level" on page 393

DISPlay<n>[:WINDow]:TRACe<t>:Y[:SCALe]:RLEVel:OFFSet <Offset>

This command defines a reference level offset.

Suffix:

<n> irrelevant

<t> irrelevant

Parameters:

<Offset> <numeric value>

Range: -100 to 100 dB

*RST: 0 dB

Default unit: dB

Example:

```
//Define a level offset
DISP:TRAC:Y:RLEV:OFFS -10dB
```

Manual operation:

See "Range / Ref Position" on page 370

See "Range / Ref Position" on page 380

DISPlay<n>[:WINDow]:TRACe<t>:Y[:SCALe]:RPOStion <Position>

This command defines the position of the reference level on the display grid.

Prerequisites for this command

- Select logarithmic scale for the y-axis (`DISPlay<n>[:WINDow]:TRACe<t>:Y:SPACing`).
For a linear scale, you cannot modify the reference position.

Suffix:

<n> irrelevant

<t> irrelevant

Parameters:

<Position> <numeric value> (integer)
 Range: 0 to 10
 *RST: 10

Example:

```
//Set the reference position to the 5th grid line
DISP:TRAC:Y:SPAC LOG
DISP:TRAC:Y:RPOS 5
```

Manual operation:

See ["Range / Ref Position"](#) on page 370
 See ["Range / Ref Position"](#) on page 380

INPut:ATTenuation <Attenuation>

This command selects the RF attenuation.

Effects of this command

- Turns off automatic selection of the attenuation and therefore the coupling to the reference level (`INPut:ATTenuation:AUTO`).
- Reference level will be adjusted if the currently defined reference level is not compatible to the selected attenuation.

Parameters:

<Attenuation> <numeric value>
 Range: 0 to 40
 Increment: 5
 *RST: 0 (AUTO is ON)
 Default unit: dB

Example:

```
//Select attenuation
INP:ATT 30dB
```

Manual operation:

See ["Attenuator"](#) on page 370
 See ["Attenuator"](#) on page 381
 See ["Attenuator"](#) on page 389
 See ["Attenuator"](#) on page 393

INPut:ATTenuation:AUTO <State>

This command turns automatic selection of the attenuation level on and off.

Parameters:

<State> ON | OFF | 1 | 0
 *RST: ON | 1

Example:

```
//Turn on automatic attenuation selection
INP:ATT:AUTO ON
```

Manual operation:

See ["Attenuator"](#) on page 370
 See ["Attenuator"](#) on page 381
 See ["Attenuator"](#) on page 389
 See ["Attenuator"](#) on page 393

INPut:ATTenuation:MODE <AttenuationMode>

This command selects the attenuation mode.

Prerequisites for this command

- Select attenuation automatically ([INPut:ATTenuation:AUTO](#)).

Parameters:

<AttenuationMode> **LDISortion**
 Select "Auto Low Distortion" mode.

LNOise
 Select "Auto Low Noise" mode.

*RST: LNOise

Example: //Select auto low noise attenuation
 INP:ATT:AUTO ON
 INP:ATT:MODE LNO

Manual operation: See ["Attenuator"](#) on page 370
 See ["Attenuator"](#) on page 381
 See ["Attenuator"](#) on page 389
 See ["Attenuator"](#) on page 393

INPut:GAIN:STATE <State>

This command turns the preamplifier on and off.

Parameters:

<State> ON | OFF | 1 | 0
 *RST: OFF | 0

Example: //Turn on preamplifier
 INP:GAIN:STAT ON

Manual operation: See ["Preamplifier"](#) on page 370
 See ["Preamplifier"](#) on page 381
 See ["Preamplifier"](#) on page 389
 See ["Preamplifier"](#) on page 393

INPut:IMPedance <Impedance>

This command selects the nominal input impedance.

The selected impedance is taken into account in all level indications of results.

When you need to select a 75 Ω impedance, the 50 Ω impedance is transformed to a higher impedance. A 75 Ω matching pad is required for this transformation. The correction value in that case is 1.76 dB = 10log(75Ω/50Ω).

Prerequisites for this command

- Select a matching pad ([INPut:IMPedance:PAD](#)).

Parameters:

<Impedance> 50 | 75
 *RST: 50
 Default unit: Ω

Example:

```
//Select input impedance
INP:IMP:PAD RAZ
INP:IMP 75
```

Manual operation:

See "[Impedance](#)" on page 370
 See "[Impedance](#)" on page 381
 See "[Impedance](#)" on page 389

INPut:IMPedance:PAD <PadType>

This command selects a matching pad required for a 75 Ω input impedance.

Parameters:

<PadType> RAM | RAZ | HZTE
HZTE
 75 Ω FSH-Z38
RAM
 75 Ω RAM
RAZ
 75 Ω RAZ

Example:

```
//Select 75  $\Omega$  input impedance and the R&S RAZ as the matching pad.
INPut:IMP 75;PAD RAZ
```

Manual operation:

See "[Impedance](#)" on page 370
 See "[Impedance](#)" on page 381
 See "[Impedance](#)" on page 389

[SENSe:]CORRection:TRANsducer<td>:SELEct <TransducerFactor>

This command selects a transducer factor.

Suffix:

<td> [Transducer](#)

Parameters:

<TransducerFactor> String containing the file name of the transducer factor. If the file does not exist, the R&S FPC creates a new transducer factor.

Example:

```
//Select primary transducer
CORR:TRAN1:SEL 'HE200A-20-200.pritrd'
//Select secondary transducer
CORR:TRAN2:SEL 'PreAmp.sectrd'
```

Manual operation:

See "[Transducer](#)" on page 371
 See "[Transducer](#)" on page 381

[SENSe:]CORRection:TRANsducer<td>:UNIT?

This command queries the unit of the current transducer factor.

Prerequisites for this command

- Select a transducer (`[SENSe:]CORRection:TRANsducer<td>:SElect`).

Suffix:

<td> [Transducer](#)

Return values:

<Unit>

Example:

```
//Query the unit of the primary transducer
CORR:TRAN1:SEL 'HE200A-20-200.pritrd'
CORR:TRAN1:UNIT?
```

Usage:

Query only

Manual operation: See "[Transducer](#)" on page 371

[SENSe:]CORRection:TRANsducer<td>[:STATE] <State>

This command turns a transducer factor on and off.

Prerequisites for this command

- Select a transducer (`[SENSe:]CORRection:TRANsducer<td>:SElect`).

Suffix:

<td> [Transducer](#)

Parameters:

<State> ON | OFF | 1 | 0
*RST: OFF | 0

Example:

```
//Turn on primary transducer
CORR:TRAN1:SEL 'HE200A-20-200.pritrd'
CORR:TRAN1 ON
//Turn on secondary transducer
CORR:TRAN2:SEL 'PreAmp.sectrd'
CORR:TRAN2 ON
```

Manual operation: See "[Transducer](#)" on page 371
See "[Transducer](#)" on page 381

UNIT<n>:POWer <Unit>

This command selects the unit displayed on the y-axis.

Suffix:

<n> irrelevant

Parameters:

<Unit> DBM | DBUV | DBMV | V | W | DUVM | DUAM | V_M | W_M2

Note that the availability of units depends on the operating mode.

*RST: dBm

Example:

```
//Select displayed unit
UNIT:POW DBUV
```

Manual operation: See "Unit" on page 370
See "Unit" on page 381

19.12.4 Bandwidth

[SENSe:]BWIDth[:RESolution].....	259
[SENSe:]BANDwidth[:RESolution].....	259
[SENSe:]BWIDth[:RESolution]:AUTO.....	260
[SENSe:]BANDwidth[:RESolution]:AUTO.....	260
[SENSe:]BWIDth:VIDeo.....	260
[SENSe:]BANDwidth:VIDeo.....	260
[SENSe:]BWIDth:VIDeo:AUTO.....	260
[SENSe:]BANDwidth:VIDeo:AUTO.....	260

[SENSe:]BWIDth[:RESolution] <Bandwidth>

[SENSe:]BANDwidth[:RESolution] <Bandwidth>

This command selects the resolution bandwidth (or measurement bandwidth).

Effects of this command

- Turns off automatic selection of resolution bandwidth ([SENSe:]BANDwidth[:RESolution]:AUTO).

Parameters:

<Bandwidth> <numeric value> (integer)

Value adjustable in 1 - 3 steps (1 Hz, 3 Hz, 10 Hz, etc.).

In addition, you can select a 200 kHz bandwidth.

Range: 1 Hz to 3 MHz

*RST: - (AUTO is set to ON)

Default unit: Hz

Example:

```
//Define resolution bandwidth
BAND 100KHZ
```

Manual operation: See "RBW: Manual" on page 371
See "RBW: Manual" on page 381
See "RBW: Manual" on page 400

[SENSe:]BWIDth[:RESolution]:AUTO <Bandwidth>

[SENSe:]BANDwidth[:RESolution]:AUTO <State>

This command turns automatic selection of the resolution bandwidth (or measurement bandwidth) on and off.

Effects of this command

- Turn on automatic RBW selection to couple the RBW to the span.

When you turn off automatic selection of the resolution bandwidth, you can select one manually with `[SENSe:]BANDwidth[:RESolution]`.

Parameters:

<State> ON | OFF | 1 | 0
 *RST: ON | 1

Example: //Turn on automatic RBW selection
 BAND:AUTO OFF

Manual operation: See "RBW: Auto" on page 371
 See "RBW: Auto" on page 400

[SENSe:]BWIDth:VIDeo <Bandwidth>

[SENSe:]BANDwidth:VIDeo <Bandwidth>

This command selects the video bandwidth.

Effects of this command

- Turns off automatic selection of video bandwidth (`[SENSe:]BANDwidth:VIDeo:AUTO`).

Parameters:

<Bandwidth> <numeric value> (integer)
 Value adjustable in 1 - 3 steps (1 Hz, 3 Hz, 10 Hz, etc.).
 Range: 1 Hz to 3 MHz
 *RST: - (AUTO is set to ON)
 Default unit: Hz

Example: //Select video bandwidth
 BAND:VID 10KHZ

Manual operation: See "VBW: Manual" on page 371

[SENSe:]BWIDth:VIDeo:AUTO <State>

[SENSe:]BANDwidth:VIDeo:AUTO <State>

This command turns automatic selection of the resolution bandwidth on and off.

Effects of this command

- Turn on automatic VBW selection to couple the VBW to the RBW.

When you turn off automatic selection of the video bandwidth, you can select one manually with `[SENSe:]BANDwidth:VIDeo`.

Parameters:

<State> ON | OFF | 1 | 0
 *RST: ON | 1

Example:

```
//Select VBW manually
BAND:VID:AUTO OFF
BAND:VID 10HZ
```

Manual operation: See "[VBW: Auto](#)" on page 371

19.12.5 Sweep Control

ABORt.....	261
[SENSe:]SWEep:TIME.....	261
[SENSe:]SWEep:TIME:AUTO.....	262
INITiate:CONTinuous.....	262
INITiate[:IMMEDIATE].....	263

ABORt

This command aborts a measurement and resets the trigger system.

To prevent overlapping execution of the subsequent command before the measurement has been aborted successfully, use the *OPC? or *WAI command after ABORt and before the next command.

Note on blocked remote control programs

If a sequential command cannot be completed, for example because a triggered sweep never receives a trigger, the remote control program will never finish and the remote channel to the R&S FPC is blocked for further commands. In this case, you must interrupt processing on the remote channel first in order to abort the measurement.

To do so, send a "Device Clear" command from the control instrument to the R&S FPC on a parallel channel to clear all currently active remote channels. Depending on the used interface and protocol, send the following commands

- **Visa:**viClear()

Now you can send the ABORt command on the remote channel performing the measurement.

Example:

```
//Abort measurement and start a new one once abort is complete
ABOR; *WAI
INIT: IMM
```

Usage:

Event

[SENSe:]SWEep:TIME <SweepTime>

This command defines the sweep time.

Effects of this command

- Turns off automatic selection of the sweep time (`[SENSe:]BANDwidth[:RESolution]:AUTO`).

Parameters:

<SweepTime> <numeric value>

The available value range is specified in the datasheet.

*RST: - (AUTO is set to ON)

Default unit: s

Example:

//Define sweep time

SWE:TIME 10s

Manual operation:

See "[Sweep Time](#)" on page 365

See "[Sweep Time: Manual](#)" on page 372

See "[Measurement Time](#)" on page 382

[SENSe:]SWEep:TIME:AUTO <State>

This command couples and decouples the sweep time to the span and the resolution and video bandwidths.

Effects of this command

- Turn on automatic sweep time selection to couple the sweep time to the span and the RBW.

When you turn off automatic selection of the sweep time, you can select one manually with `[SENSe:]SWEep:TIME`.

Parameters:

<State> ON | OFF | 1 | 0

*RST: ON | 1

Example:

//Turn on automatic selection of the sweep time

SWE:TIME:AUTO ON

Manual operation:

See "[Sweep Time: Auto](#)" on page 372

INITiate:CONTinuous <State>

This command selects the sweep mode.

To actually start the measurement, use `INITiate[:IMMediate]`.

Parameters:

<State> **ON | 1**

Select continuous sweep mode.

OFF | 0

Select single sweep mode.

Example:

//Turn on single sweep mode.

INIT:CONT OFF

- Manual operation:** See ["Continuous Measurement"](#) on page 168
 See ["Single Measurement"](#) on page 169
 See ["Continuous Sweep"](#) on page 372
 See ["Single Sweep"](#) on page 372
 See ["Continuous Scan"](#) on page 382
 See ["Single Scan"](#) on page 382
 See ["Continuous Measurement"](#) on page 390
 See ["Single Measurement"](#) on page 390
 See ["Continuous Measurement"](#) on page 394
 See ["Single Measurement"](#) on page 394
 See ["Continuous Sweep"](#) on page 400
 See ["Single Sweep"](#) on page 401

INITiate[:IMMEDIATE]

The command initiates a new measurement sequence.

Effects of this command

- In single sweep mode, with an average count > 0, the command restarts the measurement.
- When you have selected the maxhold, minhold or average trace mode the command resets the trace.

in single sweep mode, you can synchronize to the end of the measurement with *OPC, *OPC? or *WAI. In continuous sweep mode, synchronization to the end of the measurement is not possible. Thus, it is not recommended that you use continuous sweep mode in remote control, as results like trace data or markers are only valid after a single sweep end synchronization.

Example: //Start a single sweep and wait to end of sweep
 INIT:CONT OFF
 INIT; *WAI

Usage: Event

- Manual operation:** See ["Continuous Measurement"](#) on page 168
 See ["Single Measurement"](#) on page 169
 See ["Continuous Sweep"](#) on page 372
 See ["Single Sweep"](#) on page 372
 See ["Continuous Scan"](#) on page 382
 See ["Single Scan"](#) on page 382
 See ["Continuous Measurement"](#) on page 390
 See ["Single Measurement"](#) on page 390
 See ["Continuous Measurement"](#) on page 394
 See ["Single Measurement"](#) on page 394
 See ["Continuous Sweep"](#) on page 400
 See ["Single Sweep"](#) on page 401

19.12.6 Trigger

TRIGger[:SEquence]:HOLDoff[:TIME].....	264
TRIGger[:SEquence]:LEVel:VIDeo.....	264
TRIGger[:SEquence]:SLOPe.....	264
TRIGger[:SEquence]:SOURce.....	265

TRIGger[:SEquence]:HOLDoff[:TIME] <TriggerDelay>

This command defines the length of the trigger delay.

Prerequisites for this command

- Select external trigger (TRIGger[:SEquence]:SOURce).

Parameters:

<TriggerDelay> <numeric value>
 Range: 0 to 100 s
 *RST: 0 s
 Default unit: s

Example: //Define a trigger delay
 TRIG:SOUR EXT
 TRIG:SLOP POS
 TRIG:HOLD 500US

Manual operation: See "Trigger" on page 372
 See "Trigger" on page 394

TRIGger[:SEquence]:LEVel:VIDeo <TriggerLevel>

This command defines the level of the video trigger.

Prerequisites for this command

- Select span = 0 ([SENSe:]FREQuency:SPAN).
- Select video trigger source (TRIGger[:SEquence]:SOURce).

Parameters:

<TriggerLevel> <numeric value> (integer)
 Range: 0 to 100 %
 *RST: 50 %

Example: //Define video trigger condition
 FREQ:SPAN 0
 TRIG:SOUR VID
 TRIG:LEV:VID 50

Manual operation: See "Trigger" on page 372

TRIGger[:SEquence]:SLOPe <TriggerSlope>

This command selects the slope of the trigger signal.

Prerequisites for this command

- Select an external trigger source (`TRIGger [: SEQuence] : SOURce`).

Parameters:

<TriggerSlope> POSitive | NEGative
*RST: POSitive

Example:

```
//Select external trigger with a rising edge
TRIG:SOUR EXT
TRIG:SLOP NEG
```

Manual operation:

See "Trigger" on page 372
See "Trigger" on page 394

TRIGger[:SEQuence]:SOURce <TriggerSource>

This command selects the trigger source.

Parameters:

<TriggerSource> **IMMediate**
No trigger is applied.

EXTernal
Select an external trigger.

VIDeo
Select the video trigger.
The video trigger is only available if span = 0 (`[SENSe :] FREQuency : SPAN`).

*RST: IMMediate

Example:

```
//Select external trigger
TRIG:SOUR EXT
```

Manual operation:

See "Trigger" on page 372

19.12.7 Traces

<code>CALCulate<n>:MATH<t>:COPY:MEMory</code>	266
<code>CALCulate<n>:MATH<t>[:EXPRession][:DEFine]</code>	266
<code>CALCulate<n>:MATH<t>:STATe</code>	267
<code>DISPlay<n>[:WINDow]:TRACe<t>:MEMory[:STATe]</code>	267
<code>DISPlay<n>[:WINDow]:TRACe<t>:MODE</code>	267
<code>DISPlay<n>[:WINDow]:TRACe<t>[:STATe]</code>	268
<code>FORMat[:DATA]</code>	269
<code>[SENSe:]DETEctor<t>[:FUNCTion]</code>	269
<code>[SENSe:]DETEctor<t>[:FUNCTion]:AUTO</code>	270
<code>[SENSe:]SWEep:COUNT</code>	270
<code>TRACe<n>[:DATA]?</code>	270

CALCulate<n>:MATH<t>:COPY:MEMory [<MemorySlot>]

This command copies a trace into the memory of the R&S FPC.

Prerequisites for this command

- Turn on a trace with a trace mode other than "Blank" (`DISPlay<n>[:WINDow]:TRACe<t>:MODE`).

Suffix:

<n> irrelevant

<t> [Trace](#)

Setting parameters:

[<MemorySlot>] not supported

Example:

```
//Copy the trace into the memory
DISP:TRAC2 ON
DISP:TRAC2:MODE AVER
CALC:MATH2:COPY:MEM
```

Usage:

Setting only

Manual operation:

See "[Memory Traces](#)" on page 373
 See "[Memory](#)" on page 383
 See "[Memory](#)" on page 394
 See "[Memory](#)" on page 401

CALCulate<n>:MATH<t>[:EXPRession][:DEFine] <Expression>

This command defines the mathematical operation for the trace mathematics.

Prerequisites for this command

- Save a trace to the memory (`CALCulate<n>:MATH<t>:COPY:MEMory`).
- Turn on trace mathematics (`CALCulate<n>:MATH<t>:STATe`).

Suffix:

<n> irrelevant

<t> irrelevant

Parameters:

<Expression> **(IMPLIED - MEMORY)**
 Subtracts the memory trace from trace 1.
(MEMORY - IMPLIED)
 Subtracts trace 1 from the memory trace.

Example:

```
//Define trace mathematics for trace 1
DISP:TRAC ON
DISP:TRAC:MODE AVER
CALC:MATH:COPY:MEM
CALC:MATH:STAT ON
CALC:MATH (IMPLIED - MEMORY)
```

Manual operation: See "Trace Math" on page 373
See "Trace Math" on page 402

CALCulate<n>:MATH<t>:STATe <State>

This command turns trace mathematics on and off.

Suffix:

<n> irrelevant

<t> irrelevant

Parameters:

<State> ON | OFF | 1 | 0
*RST: OFF | 0

Example: //Turn on trace mathematics
CALC:MATH:STAT ON

Manual operation: See "Trace Math" on page 373
See "Trace Math" on page 402

DISPlay<n>[:WINDow]:TRACe<t>:MEMory[:STATe] <State>

This command turns the memory trace on and off.

Prerequisites for this command

- Add a trace to the memory (CALCulate<n>:MATH<t>:COPY:MEMory).

Suffix:

<n> irrelevant

<t> Trace

Parameters:

<State> ON | OFF | 1 | 0
*RST: OFF | 0

Example: //Store trace 1 into memory and turn on memory trace
DISP:TRAC1 ON
DISP:TRAC1:MODE AVER
CALC:MATH1:COPY:MEM
DISP:TRAC:MEM ON

Manual operation: See "Memory Traces" on page 373
See "Trace ► Memory" on page 383
See "Trace ► Memory" on page 395
See "Trace ► Memory" on page 401

DISPlay<n>[:WINDow]:TRACe<t>:MODE <TraceMode>

This command selects the trace mode.

If you are using the average trace mode, you can set the number of measurements with `[SENSe:]SWEep:COUNT`. Note that synchronization to the end of the average count is possible only in single sweep mode.

Suffix:

<n> irrelevant

<t> [Trace](#)

Parameters:

<TraceMode> You can turn off the trace with `DISPlay<n>[:WINDow]:TRACe<t>[:STATe]` (trace mode "Blank").

For more information about the trace modes, see "[Selecting the trace mode](#)" on page 116.

AVERage

"Average" trace mode.

BLANK

"Blank" trace mode.

MAXHold

"Max Hold" trace mode.

MINHold

"Min Hold" trace mode.

VIEW

"View" trace mode.

WRITe

"Clear / Write" trace mode.

*RST: WRITe

Example:

```
//Select trace mode
DISP:TRAC:MODE AVER
```

Manual operation:

See "[Trace Mode](#)" on page 373

See "[Trace Mode](#)" on page 383

See "[Trace Mode](#)" on page 401

DISPlay<n>[:WINDow]:TRACe<t>[:STATe] <State>

This command turns a trace on and off.

Suffix:

<n> irrelevant

<t> [Trace](#)

Parameters:

<State> ON | OFF | 1 | 0

*RST: OFF | 0

Example:

```
//Turn on trace 2
DISP:TRAC2 ON
```

Manual operation: See ["Select Trace"](#) on page 373
 See ["Show Bargraph 2"](#) on page 378
 See ["Show Trace 2"](#) on page 378
 See ["Select Trace"](#) on page 382

FORMat[:DATA] <DataFormat>

This command selects the data format that is used for transmission of trace data from the R&S FPC to the controlling computer.

Note that the command has no effect for data that you send to the R&S FPC. The R&S FPC automatically recognizes the data it receives, regardless of the format.

Parameters:

<DataFormat>

AScii

Returns the data in ASCII format, separated by commas.

REAL,32

Returns the data as 32-bit IEEE 754 floating point numbers in the "definite length block format".

*RST: AScii

In REAL,32 format, a string of return values would look like:

#42524<value 1><value 2>...<value n>

with:

- #4: Number of digits of the following number of data bytes (= 4 in this example).
- 2524: Number of following data bytes (2524, corresponds to the 631 sweep points of the R&S FPC).
- <value>: 4-byte floating point value.

Example:

```
//Select the AScii data format
FORM ASC
```

[SENSe:]DETEctor<t>[:FUNction] <Detector>

This command selects the detector.

Suffix:

<t> Trace

Parameters:

<Detector>

POSitive | NEGative | SAMPlE | RMS | AVERAge | APEak

For more information about the detectors, see [Chapter 14.8.2, "Detector"](#), on page 116.

*RST: APEak

Example:

```
//Select detector
DET POS
```

Manual operation: See ["Detector"](#) on page 373

[SENSe:]DETEctor<t>[:FUNCTion]:AUTO <State>

This command couples and decouples the detector to the trace mode.

Suffix:

<t> Trace

Parameters:

<State> ON | OFF | 1 | 0
*RST: ON | 1

Example: //Turn off automatic detector selection
DET:AUTO OFF

Manual operation: See "Detector" on page 373

[SENSe:]SWEep:COUNT <SweepCount>

This command defines the number of averages for the average trace mode.

The R&S FPC performs one sweep for sweep count 0 or 1.

Prerequisites for this command

- Select average trace mode (`DISPlay<n>[:WINDow]:TRACe<t>:MODE`).

Parameters:

<SweepCount> <numeric value> (integer)
Range: 0 to 999
*RST: 1

Example: //Average over 64 sweeps
DISP:TRAC:MODE AVER
SWE:COUN 64
//Turn on single sweep mode, start the sweep and wait for its
end
INIT:CONT OFF
INIT;*WAI

Manual operation: See "Trace Mode" on page 373
See "Trace Mode" on page 383
See "Trace Mode" on page 401

TRACe<n>[:DATA]? <ResultType>

This command queries the trace data of the current measurement.

It also transfers data from a file to a certain trace.

With the command `FORMat[:DATA]`, you can set the data format.

Suffix:

<n> irrelevant

Query parameters:

<ResultType> **TRACE1**
Query the data of trace 1.

TRACE2
Query the data of trace 2.

Return values:

<Data> <numeric value>

The R&S FPC returns 1183 values. Each value corresponds to one pixel of a trace.
The unit depends on the measurement and the unit you have set with `UNIT<n>:POWer`

Note: If you use the auto peak detector, the command reads out positive peak values only.

Example: //Read out the data for trace 1.
 TRAC:DATA? TRACE1

Usage: Query only

19.12.8 Marker

<code>CALCulate<n>:DELTaMarker<m>:AOFF</code>	271
<code>CALCulate<n>:DELTaMarker<m>:MAXimum:NEXT</code>	272
<code>CALCulate<n>:DELTaMarker<m>:MAXimum[:PEAK]</code>	272
<code>CALCulate<n>:DELTaMarker<m>:MINimum[:PEAK]</code>	273
<code>CALCulate<n>:DELTaMarker<m>[:STATE]</code>	273
<code>CALCulate<n>:DELTaMarker<m>:X</code>	273
<code>CALCulate<n>:DELTaMarker<m>:X:RELative</code>	274
<code>CALCulate<n>:DELTaMarker<m>:Y?</code>	275
<code>CALCulate<n>:MARKer<m>:AOFF</code>	275
<code>CALCulate<n>:MARKer<m>:FREQuency:MODE</code>	276
<code>CALCulate<n>:MARKer<m>:FUNCTion:CENTer</code>	276
<code>CALCulate<n>:MARKer<m>:FUNCTion:REFerence</code>	276
<code>CALCulate<n>:MARKer<m>:FUNCTion:STRack[:STATE]</code>	277
<code>CALCulate<n>:MARKer<m>:MAXimum:NEXT</code>	277
<code>CALCulate<n>:MARKer<m>:MAXimum[:PEAK]</code>	277
<code>CALCulate<n>:MARKer<m>:MINimum[:PEAK]</code>	278
<code>CALCulate<n>:MARKer<m>[:STATE]</code>	278
<code>CALCulate<n>:MARKer<m>:X</code>	279
<code>CALCulate<n>:MARKer<m>:X:SLIMits<slim>:LEFT</code>	279
<code>CALCulate<n>:MARKer<m>:X:SLIMits<slim>:RIGHT</code>	280
<code>CALCulate<n>:MARKer<m>:X:SLIMits<slim>[:STATE]</code>	280
<code>CALCulate<n>:MARKer<m>:Y?</code>	281

CALCulate<n>:DELTaMarker<m>:AOFF

This command turns off all active delta markers.

Suffix:	
<n>	irrelevant
<m>	irrelevant
Example:	//Turn off all delta markers CALC:DELT:AOFF
Usage:	Event
Manual operation:	See "All Markers Off" on page 376 See "All Markers Off" on page 385 See "All Markers Off" on page 395 See "All Markers Off" on page 403

CALCulate<n>:DELTamarker<m>:MAXimum:NEXT

This command moves a delta marker to the next higher trace maximum.

If the delta marker is not active yet, the command also turns on that delta marker.

Suffix:	
<n>	irrelevant
<m>	Marker
Example:	//Move delta marker 2 to the next higher value CALC:DELT2:MAX:NEXT
Usage:	Event
Manual operation:	See "Set To Next Peak" on page 376 See "Set To Next Peak" on page 386 See "Set To Next Peak" on page 404

CALCulate<n>:DELTamarker<m>:MAXimum[:PEAK]

This command positions a delta marker on the current trace maximum.

If the delta marker is not active yet, the command also turns on that delta marker.

Suffix:	
<n>	irrelevant
<m>	Marker
Example:	//Move delta marker 3 to the peak level CALC:DELT3:MAX
Usage:	Event
Manual operation:	See "Set To Peak" on page 376 See "Set To Peak" on page 386 See "Set To Peak" on page 404

CALCulate<n>:DELTamarker<m>:MINimum[:PEAK]

This command positions a delta marker on the current trace minimum.

If the delta marker is not active yet, the command also turns on that delta marker.

Suffix:

<n> irrelevant

<m> [Marker](#)

Example: //Move delta marker 3 to the trace minimum
CALC:DELT3:MIN

Usage: Event

Manual operation: See ["Set To Minimum"](#) on page 376
See ["Set To Minimum"](#) on page 386
See ["Set To Minimum"](#) on page 404

CALCulate<n>:DELTamarker<m>[:STATe] <State>

This command turns delta markers on and off.

Suffix:

<n> irrelevant

<m> [Marker](#)

If you set the suffix at DELTmarker to 1, or use no suffix, the R&S FPC interprets this as delta marker 2 because the first marker has to be a normal marker. If more than one normal marker (2 to 6) is already active, the command turns these markers into delta markers. If no delta marker is active yet, the command activates the delta marker and positions it on the trace maximum.

Parameters:

<State> ON | OFF | 1 | 0
*RST: OFF | 0

Example: //Turn on delta marker 3 or turn marker 3 into a delta marker.
CALC:DELT3 ON

Manual operation: See ["Marker <x>"](#) on page 374
See ["Marker <x>"](#) on page 384
See ["Marker <x>"](#) on page 395
See ["Marker <x>"](#) on page 403

CALCulate<n>:DELTamarker<m>:X <Position>

This command positions a delta marker on a certain coordinate on the x-axis.

Note that it is possible to place the marker outside the visible trace. In that case, this value is invalid.

If necessary, the corresponding delta marker is activated first.

Suffix:

<n> irrelevant

<m> [Marker](#)

Parameters:

<Position> <numeric value>

The unit depends on the measurement and marker input mode.
Hz for measurements in the frequency domain.

s for measurements in the time domain.

No unit for channel input mode ([CALCulate<n>:MARKer<m>:FREQuency:MODE](#)).

Example:

```
//Delta marker positions are relative to marker 1.
CALC:DELT:MOD REL
//Position delta marker 2 10.7 MHz to the right of marker 1.
CALC:DELT2:X 10.7MHz
//Query the absolute and relative position of delta marker 2.
CALC:DELT2:X?
CALC:DELT2:X:REL?
```

Manual operation:

See "[Marker <x>](#)" on page 374
See "[Marker <x>](#)" on page 384
See "[Marker <x>](#)" on page 395
See "[Marker <x>](#)" on page 403

CALCulate<n>:DELTamarker<m>:X:RELative <Position>

This command positions a delta marker on a position relative to the reference marker.

If necessary, the corresponding delta marker is activated first.

Suffix:

<n> irrelevant

<m> [Marker](#)

Parameters:

<Position> <numeric value>

The unit depends on the measurement and marker input mode.
Hz for measurements in the frequency domain.

s for measurements in the time domain.

No unit for channel input mode ([CALCulate<n>:MARKer<m>:FREQuency:MODE](#)).

Example:

```
//Set the delta marker at a distance of 5 kHz to the reference
position.
CALC:DELT3:X:REL 5 kHz
```

Manual operation: See "Marker <x>" on page 374
 See "Marker <x>" on page 384
 See "Marker <x>" on page 395
 See "Marker <x>" on page 403

CALCulate<n>:DELTaMarker<m>:Y?

This command queries the position of a delta marker on the y-axis.

The result is always a relative value in relation to marker 1.

If necessary, the corresponding delta marker is activated first.

To get a valid result, you have to perform a complete sweep with synchronization to the sweep end between activating the delta marker and reading out the result. This is only possible in single sweep mode.

Suffix:

<n> irrelevant

<m> [Marker](#)

Return values:

<Position> In spectrum analyzer mode, the unit depends on the unit you have set and the scaling of the vertical axis.

- dB (lin/log) for units DBM | DBPW | DBUV | DBMV | DBUA
- dB (lin), % (log) for units WATT | VOLT | AMPere

Example:

```
//Turn on single sweep mode and delta marker 2
INIT:CONT OFF
CALC:DELT2 ON
//Start a sweep and wait for its end
INIT;*WAI
//Query the position of delta marker 2
CALC:DELT2:X?
CALC:DELT2:Y?
```

Usage: Query only

Manual operation: See "Marker <x>" on page 374
 See "Marker <x>" on page 384
 See "Marker <x>" on page 395
 See "Marker <x>" on page 403

CALCulate<n>:MARKer<m>:AOFF

This command turns off all active markers, delta markers and active marker measurement functions.

This command is an event and therefore has no query and no *RST value.

Suffix:

<n> irrelevant

<m> [Marker](#)

Example:	//Turn off all markers CALC:MARK:AOFF
Usage:	Event
Manual operation:	See "All Markers Off" on page 376 See "All Markers Off" on page 385 See "All Markers Off" on page 395 See "All Markers Off" on page 403

CALCulate<n>:MARKer<m>:FREQuency:MODE <Mode>

This command selects the marker frequency display mode.

Suffix:

<n> irrelevant

<m> [Marker](#)

Parameters:

<Mode> **FREQuency**
Set the marker frequency mode to frequency input (in Hz).

CHANnel
Set the marker frequency mode to channel input (as a channel number).

Example: //Select the frequency display mode.
CALC:MARK:FREQ:MODE FREQ

Manual operation: See "Marker Display" on page 375
See "Marker Display" on page 385

CALCulate<n>:MARKer<m>:FUNCTion:CENTer

This command matches the center frequency to the frequency of a marker.

Suffix:

<n> irrelevant

<m> [Marker](#)

Example: //Match the center frequency to the frequency of marker 1
CALC:MARK1:FUNC:CENT

Manual operation: See "Center = Marker / Level = Marker" on page 376
See "Center = Marker / Level = Marker" on page 386
See "Center = Marker / Level = Marker" on page 404

CALCulate<n>:MARKer<m>:FUNCTion:REFerence

This command matches the reference level to the power level of a marker.

Suffix:

<n> irrelevant

<m>	Marker
Example:	//Match the reference level to the level of marker 1 CALC:MARK1:FUNC:REF
Usage:	Event
Manual operation:	See "Center = Marker / Level = Marker" on page 376 See "Center = Marker / Level = Marker" on page 386 See "Center = Marker / Level = Marker" on page 404

CALCulate<n>:MARKer<m>:FUNcTion:STRack[:STATe] <State>

This command turns marker tracking on and off.

Suffix:	
<n>	irrelevant
<m>	irrelevant
Parameters:	
<State>	ON OFF 1 0 *RST: OFF
Example:	//Turn on marker tracking CALC:MARK:FUNC:STR ON
Manual operation:	See "Marker Tracking" on page 377 See "Marker Tracking" on page 386 See "Marker Tracking" on page 404

CALCulate<n>:MARKer<m>:MAXimum:NEXT

This command moves a marker to the next higher trace maximum.

If the marker is not active yet, the command also turns on that marker.

Suffix:	
<n>	irrelevant
<m>	Marker
Example:	//Move marker 2 to the next higher value CALC:MARK2:MAX:NEXT
Usage:	Event
Manual operation:	See "Set To Next Peak" on page 376 See "Set To Next Peak" on page 386 See "Set To Next Peak" on page 404

CALCulate<n>:MARKer<m>:MAXimum[:PEAK]

This command positions a marker on the current trace maximum.

If the marker is not active yet, the command also turns on that marker.

Suffix:	
<n>	irrelevant
<m>	Marker
Example:	//Move marker 2 to the maximum peak CALC:MARK2:MAX
Usage:	Event
Manual operation:	See "Set To Peak" on page 376 See "Set To Peak" on page 386 See "Set To Peak" on page 404

CALCulate<n>:MARKer<m>:MINimum[:PEAK]

This command positions a marker on the current trace minimum.

If the marker is not active yet, the command also turns on that marker.

Suffix:	
<n>	irrelevant
<m>	Marker
Example:	//Move marker 2 to the trace minimum CALC:MARK2:MIN
Usage:	Event
Manual operation:	See "Set To Minimum" on page 376 See "Set To Minimum" on page 386 See "Set To Minimum" on page 404

CALCulate<n>:MARKer<m>[:STATe] <State>

This command turns markers on and off.

If you do not use a suffix at MARKer, marker 1 is turned on. If one or more delta markers (2 to 6) are already active, the command turns these delta markers into normal markers.

Suffix:	
<n>	irrelevant
<m>	Marker
Parameters:	
<State>	ON OFF 1 0 *RST: OFF 0
Example:	//Turn on marker 3 CALC:MARK3 ON

Manual operation: See "Marker <x>" on page 374
 See "Marker <x>" on page 384
 See "Marker <x>" on page 395
 See "Marker <x>" on page 403

CALCulate<n>:MARKer<m>:X <Position>

This command positions a marker on a certain coordinate on the x-axis.

If one or more delta markers (2 to 6) are already active, the command turns these delta markers into normal markers.

Note that it is possible to place the marker outside the visible trace. In that case, this value is invalid.

If necessary, the corresponding delta marker is activated first.

Suffix:

<n> irrelevant

<m> Marker

Parameters:

<Position> <numeric value>

The unit depends on the measurement and marker input mode.
 Hz for measurements in the frequency domain.

s for measurements in the time domain.

No unit for channel input mode (CALCulate<n>:MARKer<m>:FREQuency:MODE).

Example: //Position marker 2 to frequency 10.7 MHz
 CALC:MARK2:X 10.7MHz

Manual operation: See "Marker <x>" on page 374
 See "Marker <x>" on page 384
 See "Marker <x>" on page 395
 See "Marker <x>" on page 403

CALCulate<n>:MARKer<m>:X:SLIMits<slim>:LEFT <SearchLimit>

This command defines the left limit of the marker search range.

Prerequisites for this command

- Turn on marker search limits (CALCulate<n>:MARKer<m>:X:SLIMits<slim>[:STATE]).

If you perform a measurement in zero span, this command limits the evaluation range on the trace.

Suffix:

<n>, <m>, <slim> irrelevant

Parameters:

<SearchLimit>	<numeric value>
	The unit depends on the measurement: Hz for frequency domain, seconds for time domain.
Range:	The value range corresponds to the maximum span.
*RST:	- (is set to the left diagram border when switching on search limits)

Example:

See `CALCulate<n>:MARKer<m>:X:SLIMits<slim>:RIGHT`

Manual operation:

See "Search Range" on page 377
 See "Search Range" on page 387
 See "Search Range" on page 405

CALCulate<n>:MARKer<m>:X:SLIMits<slim>:RIGHT <SearchLimit>

This command defines the right limit of the marker search range.

Prerequisites for this command

- Turn on marker search limits (`CALCulate<n>:MARKer<m>:X:SLIMits<slim>[:STATe]`).

If you perform a measurement in zero span, this command limits the evaluation range on the trace.

Suffix:

<n>, <m>, <slim> irrelevant

Parameters:

<SearchLimit>	<numeric value>
	The unit depends on the measurement: Hz for frequency domain, seconds for time domain.
Range:	The value range corresponds to the maximum span.
*RST:	- (is set to the left diagram border when switching on search limits)

Example:

```
//Turn search limits on and define a search range from 10 MHz
to 100 MHz.
CALC:MARK:X:SLIM ON
CALC:MARK:X:SLIM:LEFT 10MHz
CALC:MARK:X:SLIM:RIGH 100MHz
```

Manual operation:

See "Search Range" on page 377
 See "Search Range" on page 387
 See "Search Range" on page 405

CALCulate<n>:MARKer<m>:X:SLIMits<slim>[:STATe] <State>

This command turns marker search limits on and off.

If you perform a measurement in zero span, this command limits the evaluation range on the trace.

Suffix:

<n>, <m>, <slim> irrelevant

Parameters:

<State> ON | OFF | 1 | 0
*RST: OFF | 0

Example:

See `CALCulate<n>:MARKer<m>:X:SLIMits<slim>:RIGHT`

Manual operation:

See "Search Range" on page 377
See "Search Range" on page 387
See "Search Range" on page 405

CALCulate<n>:MARKer<m>:Y?

This command queries the absolute position of a marker on the y-axis.

If necessary, the corresponding marker is activated first.

To get a valid result, you have to perform a complete sweep with synchronization to the sweep end between activating the delta marker and reading out the result. This is only possible in single sweep mode.

Suffix:

<n> irrelevant

<m> [Marker](#)

Return values:

<Position> <numeric value>
The unit depends on `UNIT<n>:POWer`

Example:

```
//Turn on single sweep mode and marker 2
INIT:CONT OFF
CALC:MARK2 ON
//Start a sweep and wait for the end
INIT;*WAI
//Query the position of marker 2
CALC:MARK2:X?
CALC:MARK2:Y?
```

Usage:

Query only

Manual operation:

See "Marker <x>" on page 374
See "Marker <x>" on page 384
See "Marker <x>" on page 395

19.12.9 Marker Functions

CALCulate<n>:MARKer<m>:COUNT:FREQUENCY?	282
CALCulate<n>:MARKer<m>:COUNT[:STATe]	282
CALCulate<n>:MARKer<m>:FUNCTION:DEModulation:HOLD	283
CALCulate<n>:MARKer<m>:FUNCTION:DEModulation:SElect	283
CALCulate<n>:MARKer<m>:FUNCTION:DEModulation[:STATe]	284
CALCulate<n>:MARKer<m>:FUNCTION:NDBDown	284
CALCulate<n>:MARKer<m>:FUNCTION:NDBDown:FREQUENCY?	285
CALCulate<n>:MARKer<m>:FUNCTION:NDBDown:RESult?	285
CALCulate<n>:MARKer<m>:FUNCTION:NDBDown:STATe	286
CALCulate<n>:MARKer<m>:FUNCTION:NOISe:RESult?	286
CALCulate<n>:MARKer<m>:FUNCTION:NOISe[:STATe]	287
SYSTem:AUDio:VOLume	287

CALCulate<n>:MARKer<m>:COUNT:FREQUENCY?

This command measures the frequency at the marker position and returns the result.

To get a valid result, you have to perform a complete sweep with synchronization to the sweep end to make sure that the R&S FPC actually reaches the frequency you want to measure. This is only possible in single sweep mode.

Prerequisites for this command

- Turn on the frequency counter (`CALCulate<n>:MARKer<m>:COUNT[:STATe]`).

Suffix:

<n>	irrelevant
<m>	irrelevant

Return values:

<Frequency>	<numeric value>
	Default unit: Hz

Example: See `CALCulate<n>:MARKer<m>:COUNT[:STATe]`

Usage: Query only

Manual operation: See "Marker Mode" on page 375

CALCulate<n>:MARKer<m>:COUNT[:STATe] <State>

This command turns the frequency counter at the marker position on and off.

You can read out the result with `CALCulate<n>:MARKer<m>:COUNT:FREQUENCY?`

To get a valid result, you have to perform a complete sweep with synchronization to the sweep end to make sure that the R&S FPC actually reaches the frequency you want to measure. This is only possible in single sweep mode.

Suffix:

<n>	irrelevant
<m>	irrelevant

Parameters:

<State> ON | OFF | 1 | 0
 *RST: OFF | 0

Example:

```
//Turn on single sweep mode and marker 1.
INIT:CONT OFF
CALC:MARK ON
//Turn on the frequency counter for marker 1.
CALC:MARK:COUN ON
//Perform a measurement and query the results of the frequency
counter.
INIT;*WAI
CALC:MARK:COUN:FREQ?
```

Manual operation: See "[Marker Mode](#)" on page 375

CALCulate<n>:MARKer<m>:FUNction:DEModulation:HOLD <Time>

This command defines the demodulation time at the marker position.

Prerequisites for this command

- Turn on a marker ([CALCulate<n>:MARKer<m>\[:STATe\]](#)).
- Turn on marker demodulation ([CALCulate<n>:MARKer<m>:FUNction:DEModulation\[:STATe\]](#)).
- Select a frequency span > 0 ([\[SENSe:\]FREQuency:SPAN](#)).
 For measurement in the time domain (span = 0), the command has no effect, because demodulation is continuous.

Suffix:

<n>, <m> irrelevant

Parameters:

<Time> <numeric value>
 Range: 100 ms to 500 s
 *RST: 500 ms
 Default unit: s

Example:

```
//Configure marker demodulation
FREQ:SPAN 100MHZ
CALC:MARK ON
CALC:MARK:X 100MHZ
CALC:MARK:FUNC:DEM ON
CALC:MARK:FUNC:DEM:SEL FM
CALC:MARK:FUNC:DEM:HOLD 3s
```

Manual operation: See "[Marker Demodulation](#)" on page 375
 See "[Marker Demodulation](#)" on page 385

CALCulate<n>:MARKer<m>:FUNction:DEModulation:SElect <Demodulation>

This command selects the demodulation type for marker demodulation.

Prerequisites for this command

- Turn on a marker (`CALCulate<n>:MARKer<m>[:STATe]`).
- Turn on marker demodulation (`CALCulate<n>:MARKer<m>:FUNction:DEModulation[:STATe]`).

Suffix:

<n>, <m> irrelevant

Parameters:

<Demodulation> AM | FM
*RST: -

Example: See `CALCulate<n>:MARKer<m>:FUNction:DEModulation:HOLD`.

Manual operation: See "Marker Demodulation" on page 375
See "Marker Demodulation" on page 385

CALCulate<n>:MARKer<m>:FUNction:DEModulation[:STATe] <State>

This command turns marker demodulation on and off.

Prerequisites for this command

- Turn on a marker (`CALCulate<n>:MARKer<m>[:STATe]`).

Suffix:

<n>, <m> irrelevant

Parameters:

<State> ON | OFF | 1 | 0
*RST: OFF | 0

Example: See `CALCulate<n>:MARKer<m>:FUNction:DEModulation:HOLD`.

Manual operation: See "Marker Demodulation" on page 375
See "Marker Demodulation" on page 385

CALCulate<n>:MARKer<m>:FUNction:NDBDown <MarkerDistance>

This command defines the distance of the n dB down markers to the reference marker.

Prerequisites for this command

- Turn on n dB down measurement (`CALCulate<n>:MARKer<m>:FUNction:NDBDown:STATe`).

Suffix:

<n> irrelevant

<m> irrelevant (the n dB down marker function always uses marker 1)

Parameters:

<MarkerDistance> <numeric value>
 Distance of the temporary markers to the reference marker in dB.
 *RST: 3 dB
 Default unit: dB

Example:

See [CALCulate<n>:MARKer<m>:FUNction:NDBDown:STATe](#)

Manual operation: See "[Marker Mode](#)" on page 375

CALCulate<n>:MARKer<m>:FUNction:NDBDown:FREquency?

This command queries the position of the n dB down markers on the x-axis.

Prerequisites for this command

- Turn on n dB down measurement ([CALCulate<n>:MARKer<m>:FUNction:NDBDown:STATe](#)).

Suffix:

<n> irrelevant
 <m> irrelevant (the n dB down marker function always uses marker 1)

Return values:

<Frequency> <frequency1>
 Absolute frequency of the n dB marker to the left of the reference marker in Hz.
 <frequency2>
 Absolute frequency of the n dB marker to the right of the reference marker in Hz.

Example:

See [CALCulate<n>:MARKer<m>:FUNction:NDBDown:STATe](#)

Usage:

Query only

Manual operation: See "[Marker Mode](#)" on page 375

CALCulate<n>:MARKer<m>:FUNction:NDBDown:RESult?

This command queries the frequency spacing or bandwidth of the n dB down markers.

Prerequisites for this command

- Turn on n dB down measurement ([CALCulate<n>:MARKer<m>:FUNction:NDBDown:STATe](#)).

Suffix:

<n> irrelevant
 <m> irrelevant (the n dB down marker function always uses marker 1)

Return values:

<Bandwidth> Default unit: Hz

Example:

See [CALCulate<n>:MARKer<m>:FUNCTion:NDBDown:STATe](#)

Usage:

Query only

Manual operation: See "[Marker Mode](#)" on page 375

CALCulate<n>:MARKer<m>:FUNCTion:NDBDown:STATe <State>

This command turns the n dB down marker function on and off.

Suffix:

<n> irrelevant

<m> irrelevant (the n dB down marker function always uses marker 1)

Parameters:

<State> ON | OFF | 1 | 0

*RST: OFF | 0

Example:

//Turn on the n dB marker function.
CALC:MARK:FUNC:NDBD:STAT ON

//Position two temporary markers 3 dB below a reference marker.
CALC:MARK:FUNC:NDBD 3

//Query the frequency position of the n dB down markers; would return e.g. 100000000,200000000
CALC:MARK:FUNC:NDBD:FREQ?

//Query the measurement result; would return e.g. 100000000
CALC:MARK:FUNC:NDBD:RES?

Manual operation: See "[Marker Mode](#)" on page 375

CALCulate<n>:MARKer<m>:FUNCTion:NOISe:RESult?

This command queries the result of the noise measurement.

To get a valid result, you have to perform a complete sweep with synchronization to the sweep end before reading out the result. This is only possible in single sweep mode.

Prerequisites for this command

- Turn on noise measurement ([CALCulate<n>:MARKer<m>:FUNCTion:NOISe\[:STATe\]](#)).

Suffix:

<n> irrelevant

<m>	Marker (Only marker 1 (M1) or delta marker 2 (D2) are possible to select.)
Return values:	
<NoiseLevel>	The unit depends on <code>UNIT<n>:POWer</code>
Example:	<pre>//Turn on single sweep mode. INIT:CONT OFF //Turn on marker and assign the noise measurement to that marker. CALC:MARK ON CALC:MARK:FUNC:NOIS ON //Perform the measurement and query the noise marker results. INIT;*WAI CALC:MARK:NOIS:RES?</pre>
Usage:	Query only
Manual operation:	See " Marker Mode " on page 375

CALCulate<n>:MARKer<m>:FUNCTion:NOISe[:STATe] <State>

This command turns the noise measurement marker function on and off.

You can query the results of the noise power density at the marker position with `CALCulate<n>:MARKer<m>:FUNCTion:NOISe:RESult?`

Suffix:

<n>	irrelevant
<m>	Marker (Only marker 1 (M1) or delta marker 2 (D2) are possible to select.)

Parameters:

<State>	ON OFF 1 0
*RST:	OFF 0

Example: See `CALCulate<n>:MARKer<m>:FUNCTion:NOISe:RESult?`

Manual operation: See "[Marker Mode](#)" on page 375

SYSTem:AUDio:VOLume <Volume>

This command sets the volume of the internal speaker.

Parameters:

<Volume>	<numeric value>
Range:	0 to 1
*RST:	0.3 (30%)

- Example:** //Set the volume to 40%.
SYST:AUD:VOL 0.40
- Manual operation:** See "Marker Demodulation" on page 375
See "Marker Demodulation" on page 385

19.12.10 Display Lines

CALCulate<n>:DLINe.....	288
CALCulate<n>:DLINe:STATe.....	288

CALCulate<n>:DLINe <LinePosition>

This command defines the position of a display line.

Prerequisites for this command

- Turn on a display line (CALCulate<n>:DLINe:STATe).

Suffix:

<n> irrelevant

Parameters:

<LinePosition> <numeric value>

You can use any unit you want, the R&S FPC then converts the unit to the currently selected unit. If you omit a unit, the R&S FPC uses the currently selected unit.

*RST: - (STATe to OFF)

Default unit: -

Example: //Position display line
CALC:DLIN:STAT ON
CALC:DLIN -20dBm

Manual operation: See "Display Line" on page 373
See "Display Line" on page 402

CALCulate<n>:DLINe:STATe <State>

This command turns display lines on and off.

Suffix:

<n> irrelevant

Parameters:

<State> ON | OFF | 1 | 0

*RST: OFF | 0

Example: //Turn on display line
CALC:DLIN:STAT ON

Manual operation: See "Display Line" on page 373
See "Display Line" on page 402

19.12.11 Limit Lines

CALCulate<n>:LIMit<k>:BEEP[:STATe].....	289
CALCulate<n>:LIMit<k>:COMMeNt?.....	289
CALCulate<n>:LIMit<k>:DEFine.....	290
CALCulate<n>:LIMit<k>:DELete.....	291
CALCulate<n>:LIMit<k>:FAIL?.....	291
CALCulate<n>:LIMit<k>:LOWer:SELect.....	292
CALCulate<n>:LIMit<k>:LOWer:THReShold.....	292
CALCulate<n>:LIMit<k>:STATe.....	293
CALCulate<n>:LIMit<k>:UNIT:X?.....	293
CALCulate<n>:LIMit<k>:UNIT[:Y]?.....	294
CALCulate<n>:LIMit<k>:UPPer:SELect.....	294
CALCulate<n>:LIMit<k>:UPPer:THReShold.....	295

CALCulate<n>:LIMit<k>:BEEP[:STATe] <State>

This command turns the beeper that beeps if a limit line is violated on and off.

Suffix:

<n>	irrelevant
<k>	Limit line

Parameters:

<State>	ON OFF 1 0
*RST:	OFF 0

Example:

```
//Activate the audio beep
CALC:LIM:BEEP ON
```

Manual operation:

See "Audio Beep" on page 374
 See "Audio Beep" on page 384
 See "Audio Beep" on page 391
 See "Audio Beep" on page 402

CALCulate<n>:LIMit<k>:COMMeNt?

This command queries the description of a limit line.

Prerequisites for this command

- Select a limit line or define a threshold limit with one of the following commands:
 - CALCulate<n>:LIMit<k>:LOWer:SELect
 - CALCulate<n>:LIMit<k>:LOWer:THReShold
 - CALCulate<n>:LIMit<k>:UPPer:SELect
 - CALCulate<n>:LIMit<k>:UPPer:THReShold

Suffix:

<n>	irrelevant
<k>	Limit line

Return values:

<Comment> String containing the description of the limit line.

Example:

```
//Query the description of limit line 1.
FREQ:SPAN 0HZ
CALC:LIM:LOW:SEL 'GSM_Lower.rellim'
CALC:LIM:COMM?
```

Usage:

Query only

CALCulate<n>:LIMit<k>:DEFine <Name>, <Description>, <X-unit>, <X-scale>, <Y-unit>, <X0>, <Y0>, <X1>, <Y1>[, <Xn>, <Yn>]

This command defines the shape of a limit line.

- After you have defined the shape of the limit line, you still have to select it with one of the following commands.
 - `CALCulate<n>:LIMit<k>:LOWer:SElect`
 - `CALCulate<n>:LIMit<k>:LOWer:THReshold`
 - `CALCulate<n>:LIMit<k>:UPPer:SElect`
 - `CALCulate<n>:LIMit<k>:UPPer:THReshold`

Suffix:

<n> irrelevant

<k> [Limit line](#)

Parameters:

<Name> String containing the name of the limit line.
Note: If a limit line with the same name already exists, it will be overwritten.

<Description> String containing a description of the limit line.

<X-unit> Hz | s

<X-scale> ABSolute | RELative

<Y-unit> DB | DBM | DBUV | DBMV | DBUVM | DBUAM | VSWR | V | W

<X_n> <numeric value>
 Data points on the x-axis.
 The first two data point are mandatory.
Note: A limit line can consist of up to 100 horizontal data points.

<Y_n> <numeric value>
 Data points on the y-axis.
 The first two data point are mandatory.

Example:

```
//Minimum requirement of two data points
CALC:LIM:DEF 'Limit', 'Empty
comment', HZ, ABS, DBM, 0, -70, 100000000000, -70
CALC:LIM:UPP:SEL 'limit.abslim'
```

Example: //More complex limit line
 CALC:LIM:DEF 'Limit', 'Empty
 comment', HZ, ABS, DBM,
 0, -70, 1000000000, -70, 1000000000, -80, 1000000000,
 -80, 1000000000, -70, 2000000000, -70
 CALC:LIM:UPP:SEL 'limit.abslim'

Usage: Setting only

CALCulate<n>:LIMit<k>:DELeTe

This command removes a limit line from the evaluation.

Removing a limit line also ends the limit check.

Prerequisites for this command

- Select a limit line or define a threshold limit with one of the following commands:
 - CALCulate<n>:LIMit<k>:LOWer:SElect
 - CALCulate<n>:LIMit<k>:LOWer:THReshold
 - CALCulate<n>:LIMit<k>:UPPer:SElect
 - CALCulate<n>:LIMit<k>:UPPer:THReshold

Suffix:

<n> irrelevant

<k> [Limit line](#)

Example: //Remove limit line
 CALC:LIM2:DEL

Manual operation: See "[Upper Limit](#)" on page 374
 See "[Lower Limit](#)" on page 374
 See "[Upper Limit](#)" on page 384
 See "[Lower Limit](#)" on page 384
 See "[Upper Limit](#)" on page 402
 See "[Lower Limit](#)" on page 402

CALCulate<n>:LIMit<k>:FAIL?

This command queries the result of a limit check.

To get a valid result, you have to perform a complete sweep with synchronization to the sweep end before reading out the result. This is only possible in single sweep mode.

Prerequisites for this command

- Select a limit line or define a threshold limit with one of the following commands:
 - CALCulate<n>:LIMit<k>:LOWer:SElect
 - CALCulate<n>:LIMit<k>:LOWer:THReshold
 - CALCulate<n>:LIMit<k>:UPPer:SElect
 - CALCulate<n>:LIMit<k>:UPPer:THReshold

Suffix:

<n> irrelevant

<k> [Limit line](#)

Return values:

<Status>

- 0 for PASS
- 1 for FAIL

Example:

//Perform a measurement and query the result of the check for limit line 1.

```
CALC:LIM:UPP:THR -70
```

```
INIT;*WAI
```

```
CALC:LIM1:FAIL?
```

Usage:

Query only

Manual operation:

See "[Upper Limit](#)" on page 374

See "[Lower Limit](#)" on page 374

See "[Upper Limit](#)" on page 384

See "[Lower Limit](#)" on page 384

See "[Upper Limit](#)" on page 402

See "[Lower Limit](#)" on page 402

CALCulate<n>:LIMit<k>:LOWer:SELEct <LimitLine>

This command selects the lower limit line.

You can either select a limit line that is already stored on the internal memory or create a new one with [CALCulate<n>:LIMit<k>:DEFine](#).

Suffix:

<n> irrelevant

<k> [Limit line](#)

Setting parameters:

<LimitLine> String containing the file name of the lower limit line.

Example:

//Select the lower limit line

```
FREQ:SPAN 0HZ
```

```
CALC:LIM:LOW:SEL 'GSM_Lower.rellim'
```

Usage:

Setting only

Manual operation:

See "[Lower Limit](#)" on page 374

See "[Lower Limit](#)" on page 384

See "[Lower Limit](#)" on page 402

CALCulate<n>:LIMit<k>:LOWer:THREshold <Level>

This command defines the level of a lower threshold limit line.

Suffix:

<n> irrelevant

<k> [Limit line](#)

Parameters:

<Level> <numeric value>

Unit depends on the unit you have currently selected for the vertical axis.

Example: //Turn on threshold limit line
CALC:LIM:LOW:THR -40DBM

Manual operation: See "[Lower Limit](#)" on page 374
See "[Lower Limit](#)" on page 384
See "[Lower Limit](#)" on page 402

CALCulate<n>:LIMit<k>:STATe <State>

This command turns a limit check on and off.

You can query the result of the limit check with `CALCulate<n>:LIMit<k>:FAIL?`

Prerequisites for this command

- Select a limit line or define a threshold limit with one of the following commands:
 - `CALCulate<n>:LIMit<k>:LOWer:SElect`
 - `CALCulate<n>:LIMit<k>:LOWer:THReshold`
 - `CALCulate<n>:LIMit<k>:UPPer:SElect`
 - `CALCulate<n>:LIMit<k>:UPPer:THReshold`

Suffix:

<n> irrelevant

<k> [Limit line](#)

Parameters:

<State> ON | OFF | 1 | 0
*RST: OFF | 0

Example: //Activate limit check
CALC:LIM:UPP:THR -70
CALC:LIM:STAT ON

Manual operation: See "[Show Limit Lines](#)" on page 374

CALCulate<n>:LIMit<k>:UNIT:X?

This command queries the unit of a limit line on the x-axis.

Prerequisites for this command

- Select a limit line or define a threshold limit with one of the following commands:
 - `CALCulate<n>:LIMit<k>:LOWer:SElect`
 - `CALCulate<n>:LIMit<k>:LOWer:THReshold`
 - `CALCulate<n>:LIMit<k>:UPPer:SElect`

– `CALCulate<n>:LIMit<k>:UPPer:THReshold`

Suffix:

<n> irrelevant

<k> [Limit line](#)

Return values:

<Unit>

Example:

```
//Query the x-unit of the first limit line.
CALC:LIM:UPP:THR -70
CALC:LIM:UNIT:X?
```

Usage:

Query only

CALCulate<n>:LIMit<k>:UNIT[:Y]?

This command queries the level unit of a limit line.

Prerequisites for this command

- Select a limit line or define a threshold limit with one of the following commands:

– `CALCulate<n>:LIMit<k>:LOWer:SElect`

– `CALCulate<n>:LIMit<k>:LOWer:THReshold`

– `CALCulate<n>:LIMit<k>:UPPer:SElect`

– `CALCulate<n>:LIMit<k>:UPPer:THReshold`

Suffix:

<n> irrelevant

<k> [Limit line](#)

Return values:

<Unit> Level unit of the limit line.

Example:

```
//Query the level unit of a limit line
CALC:LIM:UPP:THR -70
CALC:LIM:UNIT?
```

Usage:

Query only

CALCulate<n>:LIMit<k>:UPPer:SElect <LimitLine>

This command selects the upper limit line.

You can either select a limit line that is already stored on the internal memory or create a new one with `CALCulate<n>:LIMit<k>:DEFine`.

Suffix:

<n> irrelevant

<k> [Limit line](#)

Setting parameters:

<LimitLine> String containing the file name of the upper limit line

Example:	//Select the upper limit line. FREQ:SPAN 0HZ CALC:LIM:UPP:SEL 'GSM_Upper.rellim'
Usage:	Setting only
Manual operation:	See " Upper Limit " on page 374 See " Upper Limit " on page 384 See " Upper Limit " on page 402

CALCulate<n>:LIMit<k>:UPPer:THReshold <Level>

This command defines the level of an upper threshold limit line.

Suffix:

<n> irrelevant

<k> [Limit line](#)

Parameters:

<Level> <numeric value>

Unit depends on the unit you have currently selected for the vertical axis.

Example: //Turn on threshold limit line
CALC:LIM:UPP:THR -10DBM

Manual operation: See "[Upper Limit](#)" on page 374
See "[Upper Limit](#)" on page 384
See "[Upper Limit](#)" on page 402

19.13 Remote Commands of the Receiver Application

- [Measurement Configuration](#).....295
- [Frequency](#).....296
- [Amplitude](#).....299
- [Bandwidth](#).....299
- [Sweep Control](#).....300
- [Traces](#).....300
- [Marker](#).....302

19.13.1 Measurement Configuration

- [DISPlay:BARGraph:PHOLd:RESet](#).....296
- [\[SENSe:\]FREQuency:MODE](#).....296
- [TRACe\[:DATA\]?](#).....296

DISPlay:BARGraph:PHOLd:RESet

This command resets the maxhold information in the fixed frequency measurement and the frequency scan.

Example: //Reset maxhold information
 DISP: BARG: PHOL: RES

Usage: Event

Manual operation: See "[Refresh Max Hold](#)" on page 378

[SENSe:]FREQuency:MODE <Mode>

This command select the receiver measurement mode.

Parameters:
<Mode> **FIXed | CW**
 Selects bargraph measurements.
 SCAN
 Selects frequency scan measurements.
 *RST: FIXed

Example: //Select frequency scan
 FREQ: MODE SCAN

Manual operation: See "[Bargraph](#)" on page 378
 See "[Frequency Scan](#)" on page 378

TRACe[:DATA]?

This command queries the trace data (measurement results in graphical result displays).

Prerequisites for this command

- Select graphical result display ([CALCulate<n>:FEED](#)).

Return values:
<Results> Returns one value for each measurement point.
 The type of value depends on the measurement (Hz for FM,
 PCT for AM).

Example: //Query FM results
 CALC: FEED 'XTIME: FM'
 TRAC?

Usage: Query only

19.13.2 Frequency

Commands to configure the frequency described elsewhere.

- Frequency stepsize:

[SENSe:]FREQuency:CENTer:STEP

- Frequency mode (frequency / channel):

[SENSe:]FREQuency:INPut:MODE

- Channel selection:

[SENSe:]CHANnel

[SENSe:]FREQuency:CENTer.....	297
[SENSe:]SCAN:START.....	297
[SENSe:]SCAN:STEP.....	297
[SENSe:]SCAN:STOP.....	298
[SENSe:]SWEep:SPACing.....	298

[SENSe:]FREQuency:CENTer <Frequency>

This command defines the receiver frequency.

Prerequisites for this command

- Select bargraph measurement ([SENSe:]FREQuency:MODE).

Parameters:

<Frequency> <numeric value>
 Default unit: Hz

Example: //Define a receiver frequency for bargraph measurement
 FREQ:MODE FIX
 FREQ:CENT 100MHZ

Manual operation: See "Frequency" on page 379

[SENSe:]SCAN:START <Frequency>

This command defines the start frequency for a frequency scan.

Prerequisites for this command

- Select frequency scan ([SENSe:]FREQuency:MODE).

Parameters:

<Frequency> <numeric value>
 Default unit: Hz

Example: //Define scan range with measurement every 10 MHz
 FREQ:MODE SCAN
 SCAN:STAR 30MHZ
 SCAN:STOP 100MHZ
 SCAN:STEP 10MHZ

Manual operation: See "Start Frequency" on page 379

[SENSe:]SCAN:STEP <StepSize>

This command defines the frequency step size for a frequency scan.

Prerequisites for this command

- Select frequency scan ([SENSe:]FREQuency:MODE).

Parameters:

<StepSize> <numeric value>
 Default unit: Hz

Example: //Define scan range with measurement every 10 MHz
 FREQ:MODE SCAN
 SCAN:STAR 30MHZ
 SCAN:STOP 100MHZ
 SCAN:STEP 10MHZ

Manual operation: See "[Scan Step](#)" on page 379

[SENSe:]SCAN:STOP <Frequency>

This command defines the stop frequency for a frequency scan.

Prerequisites for this command

- Select frequency scan ([SENSe:]FREQuency:MODE).

Parameters:

<Frequency> <numeric value>
 Default unit: Hz

Example: //Define scan range with measurement every 10 MHz
 FREQ:MODE SCAN
 SCAN:STAR 30MHZ
 SCAN:STOP 100MHZ
 SCAN:STEP 10MHZ

Manual operation: See "[Stop Frequency](#)" on page 379

[SENSe:]SWEp:SPACing <Scale>

This command selects the scale of the x-axis.

Parameters:

<Scale> **LINear**
 Linear scaling of the x-axis.
 LOGarithmic
 Logarithmic scaling of the x-axis.
 *RST: LINear

Example: //Select scaling of the x-axis
 SWE:SPAC LOG

Manual operation: See "[Linear Scale](#)" on page 379
 See "[Log Scale](#)" on page 380

19.13.3 Amplitude

Commands to configure amplitude described elsewhere.

- Reference level:
`DISPlay<n>[:WINDow]:TRACe<t>:Y[:SCALe]:RLEVEL`
- Level range:
`DISPlay<n>[:WINDow]:TRACe<t>:Y:SPACing`
`DISPlay<n>[:WINDow]:TRACe<t>:Y[:SCALe]`
`DISPlay<n>[:WINDow]:TRACe<t>:Y[:SCALe]:ADJust`
- Reference position:
`DISPlay<n>[:WINDow]:TRACe<t>:Y[:SCALe]:RPOSITION`
- Reference offset:
`DISPlay<n>[:WINDow]:TRACe<t>:Y[:SCALe]:RLEVEL:OFFSet`
- Unit:
`UNIT<n>:POWER`
- Preamplifier:
`INPut:GAIN:STATE`
- Attenuation:
`INPut:ATTenuation`
`INPut:ATTenuation:AUTO`
`INPut:ATTenuation:MODE`
- Impedance:
`INPut:IMPedance`
`INPut:IMPedance:PAD`
- Transducer:
`[SENSe:]CORRection:TRANsducer<td>:SElect`
`[SENSe:]CORRection:TRANsducer<td>:UNIT?`
`[SENSe:]CORRection:TRANsducer<td>[:STATE]`

19.13.4 Bandwidth

Commands to configure the bandwidth described elsewhere.

- Resolution bandwidth (3 dB):
`[SENSe:]BANDwidth[:RESolution]`

`[SENSe:]BANDwidth[:RESolution]:CISPr..... 299`
`[SENSe:]BANDwidth[:RESolution]:CISPr:AUTO..... 300`

[SENSe:]BANDwidth[:RESolution]:CISPr <Bandwidth>

This command selects the CISPR (6 dB) bandwidth for CISPR conform measurements.

Parameters:

<Bandwidth> 200HZ | 9KHZ | 120KHZ | 1MHZ
Default unit: Hz

Example: //Select CISPT bandwidth
BAND:CISP 9KHZ

Manual operation: See "[CISPR BW: Manual](#)" on page 381

[SENSe:]BANDwidth[:RESolution]:CISPr:AUTO <State>

This command turns automatic selection of the CISPR measurement bandwidth on and off.

Parameters:

<State> ON | OFF | 1 | 0
*RST: OFF

Example: //Select CISPR bandwidth manually
BAND:CISP:AUTO OFF
BAND:CISP 120KHZ

Manual operation: See "[CISPR BW: Auto](#)" on page 382

19.13.5 Sweep Control

Commands to control the measurement described elsewhere.

- Measurement control:
`INITiate[:IMMediate]`
- Measurement type (single / continuous):
`INITiate:CONTinuous`
- Measurement time:
`[SENSe:]SWEep:TIME`

19.13.6 Traces

Commands to configure traces described elsewhere.

- Trace mode:
`DISPlay<n>[:WINDow]:TRACe<t>:MODE`
- Memory trace:
`DISPlay<n>[:WINDow]:TRACe<t>:MEMory[:STATE]`
- Data format of trace export:
`FORMat[:DATA]`

<code>[SENSe:]DETEctor<t>[:FUNCTion]</code>	300
<code>DISPlay[:WINDow]:TRACe:STYLE</code>	301
<code>TRACe[:DATA]?</code>	301

[SENSe:]DETEctor<t>[:FUNCTion] <Detector>

This command selects the detector.

Suffix:	<t>	Trace
Parameters:	<Detector>	AVERAge POSitive QPEak RMS *RST: POSitive
Example:		//Select quasipeak detector DET QPE
Manual operation:		See "Detector" on page 378 See "Detector" on page 383

DISPlay[:WINDow]:TRACe:STYLe <Style>

This command selects the style of the trace display.

Prerequisites for this command

- Select frequency scan ([SENSe:]FREQuency:MODE).

Parameters:	<TraceStyle>	LINEs Shows the results in form of a line trace with interpolation between the receiver frequencies.
		POLYgon Shows the results in form of vertical lines at each receiver frequency.
		*RST: POLYgon
Example:		//Display a line trace FREQ:MODE SCAN DISP:TRAC:STYL LIN
Manual operation:		See "Trace Style: Lines" on page 383 See "Trace Style: Polygon" on page 383

TRACe[:DATA]?

This command queries the trace data (measurement results in graphical result displays).

Query parameters:

<ResultType> If you do not specify a parameter, the command queries the latest measurement results.

PHOLd

Queries the maxhold information of the bargraph or frequency scan.

Return values:

<Result> When you query the fixed frequency measurement result, the command returns one value: the level for the current receiver frequency.
 When you query frequency scan results, the command returns several level values. The number of return values depends on the number of measurement frequencies.

Example:

```
//Query measurement results
TRAC?
//Query maxhold information
TRAC? PHOL
```

Usage:

Query only

19.13.7 Marker

Note that markers are only available for the frequency scan.

Commands to configure markers described elsewhere.

- Marker state (on / off):
`CALCulate<n>:MARKer<m>[:STATe]`
`CALCulate<n>:MARKer<m>:AOFF`
- Marker input mode:
`CALCulate<n>:MARKer<m>:FREQuency:MODE`
- Marker position:
`CALCulate<n>:MARKer<m>:X`
`CALCulate<n>:MARKer<m>:Y?`
- Marker position: set to peak:
`CALCulate<n>:MARKer<m>:MAXimum[:PEAK]`
- Marker position: set to next peak:
`CALCulate<n>:MARKer<m>:MAXimum:NEXT`
- Marker position: set to minimum:
`CALCulate<n>:MARKer<m>:MINimum[:PEAK]`
- Marker search range:
`CALCulate<n>:MARKer<m>:X:SLIMits<slim>:LEFT`
`CALCulate<n>:MARKer<m>:X:SLIMits<slim>:RIGHT`
`CALCulate<n>:MARKer<m>:X:SLIMits<slim>[:STATe]`

Commands to configure delta markers described elsewhere.

- Delta marker state (on / off):
`CALCulate<n>:DELTamarker<m>[:STATe]`
`CALCulate<n>:DELTamarker<m>:AOFF`
- Delta marker position:
`CALCulate<n>:DELTamarker<m>:X`
- `CALCulate<n>:DELTamarker<m>:X:RELative`

- `CALCulate<n>:DELTaMarker<m>:Y?`
- Delta marker position: set to peak:
`CALCulate<n>:DELTaMarker<m>:MAXimum[:PEAK]`
- Delta marker position: set to next peak:
`CALCulate<n>:DELTaMarker<m>:MAXimum:NEXT`
- Delta marker position: set to minimum:
`CALCulate<n>:DELTaMarker<m>:MINimum[:PEAK]`

Commands to configure marker demodulation described elsewhere.

- Demodulation state:
`CALCulate<n>:MARKer<m>:FUNction:DEModulation[:STATe]`
- Demodulation domain:
`CALCulate<n>:MARKer<m>:FUNction:DEModulation:SElect`
- Demodulation time:
`CALCulate<n>:MARKer<m>:FUNction:DEModulation:HOLD`

`CALCulate<n>:MARKer<m>:FUNction:FIXed`.....303

CALCulate<n>:MARKer<m>:FUNction:FIXed

This command synchronizes the bargraph frequency to one of the marker frequencies in the frequency scan.

At the same, the command switches to the fixed frequency measurement.

Suffix:

<n>, <m> irrelevant

Usage: Event

Manual operation: See "Marker To Fixed Freq" on page 385

19.14 Remote Commands of the Analog Demodulation

• Measurements and Result Displays	303
• Frequency	308
• Amplitude	309
• Bandwidth	309
• Sweep Control	311
• Limits	312

19.14.1 Measurements and Result Displays

<code>CALCulate<n>:FEED</code>	304
<code>CALCulate<n>:MARKer:FUNction:ADEMod:AFRequency[:RESult]?</code>	304
<code>CALCulate<n>:MARKer:FUNction:ADEMod:AM[:RESult]?</code>	305
<code>CALCulate<n>:MARKer:FUNction:ADEMod:CARRier[:RESult]?</code>	305

CALCulate<n>:MARKer:FUNCTION:ADEMod:FERRor[:RESult]?	305
CALCulate<n>:MARKer:FUNCTION:ADEMod:FM[:RESult]?	306
CALCulate<n>:MARKer:FUNCTION:ADEMod:MINdex[:RESult]?	306
CALCulate<n>:MARKer:FUNCTION:ADEMod:MRAT[:RESult]?	307
CALCulate<n>:MARKer:FUNCTION:ADEMod:SINad[:RESult]?	307
CALCulate<n>:MARKer:FUNCTION:ADEMod:THD[:RESult]?	307
[SENSe:]ADEMod:FM:OFFSet?	308
TRACe[:DATA]?	308

CALCulate<n>:FEED <ResultDisplay>

This command selects the result display.

Suffix:

<n> irrelevant

Parameters:

<ResultDisplay> **'XTime:AM'**
Graphical AM results.
'XTime:AMS'
Numerical AM results.
'XTime:FM'
Graphical FM results.
'XTime:FMS'
Numerical FM results.
*RST: 'XTime:FMS'

Example: //Select graphical AM results
CALC:FEED 'XTime:AM'

Manual operation: See "AM Domain" on page 387
See "FM Domain" on page 387
See "Mod. Trace" on page 388
See "Mod. Summary" on page 388

CALCulate<n>:MARKer:FUNCTION:ADEMod:AFRequency[:RESult]?

This command queries the modulation frequency.

Suffix:

<n> irrelevant

Return values:

<Frequency> <numeric value>
Default unit: Hz

Example: //Query modulation frequency
CALC:MARK:FUNC:ADEM:AFR?

Usage: Query only

CALCulate<n>:MARKer:FUNCTION:ADEMod:AM[:RESult]? <MeasType>

This command queries the modulation characteristics of an AM signal.

Prerequisites for this command

- Measure an AM signal (**CALCulate<n>:FEED**).

Suffix:

<n> irrelevant

Query parameters:

<MeasType>

MIDDLE

Queries the average modulation index.

MPEak

Queries the minimum modulation index.

PPEak

Queries the maximum modulation index.

RMS

Queries the RMS value of the modulation index.

Return values:

<Result> <numeric value>
Default unit: PCT

Example:

```
//Query average modulation index
CALC:FEED 'XTIM:AMS'
CALC:MARK:FUNC:ADEM:AM? MIDD
```

Usage:

Query only

CALCulate<n>:MARKer:FUNCTION:ADEMod:CARRier[:RESult]?

This command queries the power of the signal carrier.

Suffix:

<n> irrelevant

Return values:

<Power> <numeric value>
Default unit: dBm

Example:

```
//Query carrier power
CALC:MARK:FUNC:ADEM:CARR?
```

Usage:

Query only

CALCulate<n>:MARKer:FUNCTION:ADEMod:FERRor[:RESult]?

This command queries the carrier frequency offset.

Suffix:

<n> irrelevant

Return values:

<FrequencyError> <numeric value>
Default unit: Hz

Example:

```
//Query carrier frequency offset
CALC:MARK:FUNC:ADEM:FERR?
```

Usage:

Query only

CALCulate<n>:MARKer:FUNCTION:ADEMod:FM[:RESult]? <MeasType>

This command queries the modulation characteristics of an FM signal.

Prerequisites for this command

- Measure an FM signal (`CALCulate<n>:FEED`).

Suffix:

<n> irrelevant

Query parameters:

<MeasType> **MIDDLE**
Queries the average frequency deviation.
MPEak
Queries the minimum frequency deviation.
PPEak
Queries the maximum frequency deviation.
RMS
Queries the RMS value of the frequency deviation.

Return values:

<Result> Default unit: Hz

Example:

```
//Query average frequency deviation
CALC:FEED 'XTIM:FMS'
CALC:MARK:FUNC:ADEM:FM? MIDD
```

Usage:

Query only

CALCulate<n>:MARKer:FUNCTION:ADEMod:MINdex[:RESult]?

This command queries the modulation index.

Prerequisites for this command

- Measure an AM signal (`CALCulate<n>:FEED`).

Suffix:

<n> irrelevant

Return values:

<ModIndex> <numeric value>
Default unit: PCT

Example: //Query modulation index
 CALC:FEED 'XTIM:AMS'
 CALC:MARK:FUNC:ADEM:MIND?

Usage: Query only

CALCulate<n>:MARKer:FUNCtion:ADEMod:MRAT[:RESult]?

This command queries the modulation rate.

Prerequisites for this command

- Measure a FM signal (CALCulate<n>:FEED).

Suffix:
 <n> irrelevant

Return values:
 <numeric value> Default unit: PCT

Example: //Query modulation rate
 CALC:FEED 'XTIM:FMS'
 CALC:MARK:FUNC:ADEM:MRAT?

Usage: Query only

CALCulate<n>:MARKer:FUNCtion:ADEMod:SINad[:RESult]?

This command queries the SINAD result.

Suffix:
 <n> irrelevant

Return values:
 <SINAD> <numeric value>
 Default unit: dB

Example: //Query SINAD result
 CALC:MARK:FUNC:SIN?

Usage: Query only

CALCulate<n>:MARKer:FUNCtion:ADEMod:THD[:RESult]?

This command queries the THD result.

Suffix:
 <n> irrelevant

Return values:
 <THD> <numeric value>
 Default unit: dB

Example: //Query THD result
 CALC:MARK:FUNC:ADEM:THD?

Usage: Query only

[SENSe:]ADEMod:FM:OFFSet?

This command queries the frequency deviation.

Prerequisites for this command

- Measure an FM signal (`CALCulate<n>:FEED`).

Return values:

<Frequency> <numeric value>
 Default unit: Hz

Example: //Query frequency deviation
`CALC:FEED 'XTIM:FMS'`
`ADEM:FM:OFFS?`

Usage: Query only

TRACe[:DATA]?

This command queries the trace data (measurement results in graphical result displays).

Prerequisites for this command

- Select graphical result display (`CALCulate<n>:FEED`).

Return values:

<Results> Returns one value for each measurement point.
 The type of value depends on the measurement (Hz for FM,
 PCT for AM).

Example: //Query FM results
`CALC:FEED 'XTIME:FM'`
`TRAC?`

Usage: Query only

19.14.2 Frequency

Commands to configure the frequency described elsewhere.

- Center frequency:
`[SENSe:]FREQuency:CENTer`
- Frequency stepsize:
`[SENSe:]FREQuency:CENTer:STEP`

19.14.3 Amplitude

Commands to configure amplitude described elsewhere.

- Reference level:
`DISPlay<n>[:WINDow]:TRACe<t>:Y[:SCALe]:RLEVel`
- Preamplifier:
`INPut:GAIN:STATe`
- Attenuation:
`INPut:ATTenuation`
`INPut:ATTenuation:AUTO`
`INPut:ATTenuation:MODE`
- Impedance:
`INPut:IMPedance`
`INPut:IMPedance:PAD`

`DISPlay<n>[:WINDow]:TRACe<t>:Y[:SCALe]:PDIVision`..... 309

`DISPlay<n>[:WINDow]:TRACe<t>:Y[:SCALe]:PDIVision <Scale>`

This command defines the range of the y-axis for the graphical results.

Suffix:

<n> irrelevant
<t> irrelevant

Parameters:

<Scale> <numeric value> (integer only)
The unit depends on the result.

- PCT for AM results (0.1 to 100 % per grid division).
- Hz for FM results (1 kHz to 1 MHz per grid division).

Example: //Define grid scale of AM results (50 percent per grid)
`CALC:FEED 'XTIM:AM'`
`DISP:TRAC:Y:PDIV 50`

Manual operation: See "[Deviation per Division](#)" on page 389

19.14.4 Bandwidth

`[SENSe:]ADEMod:BWIDth:DEModulation`..... 310
`[SENSe:]ADEMod:BANDwidth:DEModulation`..... 310
`[SENSe:]ADEMod:BWIDth:RDEViation`..... 310
`[SENSe:]ADEMod:BANDwidth:RDEViation`..... 310
`[SENSe:]FILTer:DEMPHasis[:STATe]`..... 310
`[SENSe:]FILTer:DEMPHasis:TCONstant`..... 311
`[SENSe:]FILTer:LPASs`..... 311

[SENSe:]ADEMod:BWIDth:DEModulation <Bandwidth>

[SENSe:]ADEMod:BANDwidth:DEModulation <Bandwidth>

This command selects the demodulation bandwidth.

Parameters:

<Bandwidth> <numeric value> (integer only)
 Refer to the datasheet for a list of supported bandwidths.
 *RST: 200 kHz
 Default unit: Hz

Example: //Select demodulation bandwidth
 ADEM:BAND:DEM 50KHZ

Manual operation: See "[Manual DBW](#)" on page 389

[SENSe:]ADEMod:BWIDth:RDEVIation <Deviation>

[SENSe:]ADEMod:BANDwidth:RDEVIation <Deviation>

This command defines the reference deviation for FM signals.

Prerequisites for this command

- Select FM measurements ([CALCulate<n>:FEED](#)).

Parameters:

<Deviation> <numeric value>
 *RST: 100 kHz
 Default unit: Hz

Example: //Define reference deviation
 CALC:FEED 'XTIM:FMS '
 ADEM:BAND:RDEV 75KHZ

Manual operation: See "[Reference Deviation](#)" on page 390

[SENSe:]FILTer:DEMPHasis[:STATe] <State>

This command turns the deemphasis filter on and off.

You can select the time constant of the filter with [\[SENSe:\]FILTer:DEMPHasis:TCOnstant](#).

Prerequisites for this command

- Select 200 kHz or 300 kHz demodulation bandwidth ([\[SENSe:\]ADEMod:BANDwidth:DEModulation](#)).

Parameters:

<State> ON | OFF | 1 | 0
 *RST: OFF

Example: //Turn on deemphasis filter
 ADEM:BAND:DEM 300KHZ
 FILT:DEMP ON

Manual operation: See "FM Broadcast" on page 389

[SENSe:]FILTer:DEMPHasis:TCONstant <Time>

This command selects the time constant of the deemphasis filter.

Prerequisites for this command

- Select 200 kHz or 300 kHz demodulation bandwidth ([SENSe:]ADEMod: BANDwidth:DEModulation).
- Turn on deemphasis filter ([SENSe:]FILTer:DEMPHasis[:STATe]).

Parameters:

<Time> <numeric value>: 50us | 75us
 *RST: Deemphasis = OFF
 Default unit: s

Example: //Select 75 us time constant
 ADEM:BAND:DEM 300KHZ
 FILT:DEMP ON
 FILT:DEMP:TCON 75US

Manual operation: See "FM Broadcast" on page 389

[SENSe:]FILTer:LPASs <Filter>

This command selects the audio lowpass filter.

Parameters:

<Filter> DBW1 | DBW10 | DBW30 | DBW100

Example: //Select audio lowpass filter
 FILT:LPAS DBW10

Manual operation: See "Audio Lowpass" on page 387

19.14.5 Sweep Control

Commands to control the measurement described elsewhere.

- Measurement control:
 INITiate[:IMMediate]
- Measurement type (single / continuous):
 INITiate:CONTinuous

[SENSe:]ADEMod:MTIME?..... 311

[SENSe:]ADEMod:MTIME?

This command queries the measurement time.

Return values:

<Time> <numeric value>
 Default unit: s

Example: //Query measurement time
 ADEM:MTIM?

Usage: Query only

19.14.6 Limits

Commands to configure limits described elsewhere.

- Beeper:

`CALCulate<n>:LIMit<k>:BEEP[:STATe]`

<code>CALCulate<n>:ADEMod:LIMit:DELeTe</code>	312
<code>CALCulate<n>:ADEMod:LIMit:FAIL?</code>	312
<code>CALCulate<n>:ADEMod:LIMit:SELeCt</code>	313

CALCulate<n>:ADEMod:LIMit:DELeTe

This command removes a set of limit values from the measurement. Limit check is no longer possible.

Prerequisites for this command

- Load a set of limit values (`CALCulate<n>:ADEMod:LIMit:SELeCt`).

Suffix:

<n> irrelevant

Example: //Delete limit values
 CALC:ADEM:LIM:DEL

Usage: Event

Manual operation: See "Clear Limits" on page 390

CALCulate<n>:ADEMod:LIMit:FAIL?

This command queries the results of the limit check.

Prerequisites for this command

- Load a set of limit values (`CALCulate<n>:ADEMod:LIMit:SELeCt`).

Suffix:

<n> irrelevant

Example: //Query limit check results
 CALC:ADEM:LIM:FAIL?

Usage: Query only

CALCulate<n>:ADEMod:LIMit:SElect <Filename>

This command selects a set of limit values for AM and FM measurements.

Selecting a set of limit values automatically initiates a limit check of the numerical results.

Suffix:

<n> irrelevant

Parameters:

<Filename> String containing the file name of the limits definition file.
The file extension is either `.amlim` (AM limits) or `.fmlim` (FM limits).

Example:

```
//Load limit values for AM measurement
CALC:ADEM:LIM:SEL 'limits.amlim'
```

Manual operation: See "[Select Limits](#)" on page 390

19.15 Remote Commands of the Digital Demodulation

• Measurements and Result Displays	313
• Measurement Configuration	318
• Frequency	320
• Amplitude	320
• Sweep Control	322
• Trigger	322
• Marker	323

19.15.1 Measurements and Result Displays

CALCulate<n>:FEED	313
CALCulate<n>:MARKer:FUNCTion:DDEMod:CARRier[:RESult]?	314
CALCulate<n>:MARKer:FUNCTion:DDEMod:CFDRift[:RESult]?	314
CALCulate<n>:MARKer:FUNCTion:DDEMod:CFERror[:RESult]?	315
CALCulate<n>:MARKer:FUNCTion:DDEMod:MDEPth[:RESult]?	315
CALCulate<n>:MARKer:FUNCTion:DDEMod:MDEViation[:RESult]?	315
CALCulate<n>:MARKer:FUNCTion:DDEMod:MERRor[:RESult]?	316
CALCulate<n>:MARKer:FUNCTion:DDEMod:MINDEX[:RESult]?	316
CALCulate<n>:MARKer:FUNCTion:DDEMod:MOERror[:RESult]?	316
CALCulate<n>:MARKer:FUNCTion:DDEMod:MPower[:RESult]?	317
[SENSe:]DDEMod	317
[SENSe:]DDEMod:FSK:OFFSet?	317
TRACe[:DATA]?	318

CALCulate<n>:FEED <ResultDisplay>

This command selects the result display.

Suffix:

<n> irrelevant

Parameters:

<ResultDisplay> **'XTIM:DDEM:ERR:MPH'**
 Selects the modulation error result display.

'XTIM:DDEM:EYE'
 Selects the eye diagram.

'XTIM:DDEM:MEAS'
 Selects the modulation depth (ASK) or modulation deviation (FSK) result display.

'XTIM:DDEM:SYMB'
 Selects the symbol stream result display.

*RST: 'XTIM:DDEM:MEAS'

Example:

```
//Select eye diagram
CALC:FEED 'XTIM:DDEM:EYE'
```

Manual operation:

See ["Eye Diagram"](#) on page 392
 See ["Symbols"](#) on page 392
 See ["Modulation Depth / Modulation Deviation"](#) on page 392
 See ["Modulation Error"](#) on page 392

CALCulate<n>:MARKer:FUNctio:n:DDEMod:CARRier[:RESult]?

This command queries the carrier power of the measured signal.

Suffix:

<n> irrelevant

Return values:

<Power> <numeric value>
 Default unit: dBm

Example:

```
//Query carrier power
CALC:MARK:FUNC:DDEM:CARR?
```

Usage:

Query only

CALCulate<n>:MARKer:FUNctio:n:DDEMod:CFDRift[:RESult]?

This command queries the carrier frequency drift of the measured signal.

Prerequisites for this command

- Select FSK demodulation ([\[SENSe:\]DDEMod](#)).

Suffix:

<n> irrelevant

Return values:

<Frequency> <numeric value>
 Default unit: Hz/symbol

Example: //Query carrier frequency drift
CALC:MARK:FUNC:DDEM:CFDR?

Usage: Query only

CALCulate<n>:MARKer:FUNCTION:DDEMod:CFERror[:RESult]?

This command queries the carrier frequency error of the measured signal.

Suffix:
<n> irrelevant

Return values:
<Frequency> <numeric value>
Default unit: Hz

Example: //Query carrier frequency error
CALC:MARK:FUNC:DDEM:CFER?

Usage: Query only

CALCulate<n>:MARKer:FUNCTION:DDEMod:MDEPth[:RESult]?

This command queries the modulation depth of the measured signal.

Prerequisites for this command

- Select ASK demodulation ([SENSe:] DDEMod).

Suffix:
<n> irrelevant

Return values:
<ModIndex> <numeric value>
Default unit: PCT

Example: //Query modulation depth
CALC:MARK:FUNC:DDEM:MDEP?

Usage: Query only

CALCulate<n>:MARKer:FUNCTION:DDEMod:MDEViation[:RESult]?

This command queries the frequency deviation of the measured signal.

Prerequisites for this command

- Select FSK demodulation ([SENSe:] DDEMod).

Suffix:
<n> irrelevant

Return values:
<Frequency> <numeric value>
Default unit: Hz

Example: //Query frequency deviation
CALC:MARK:FUNC:DDEM:MDEV?

Usage: Query only

CALCulate<n>:MARKer:FUNCtion:DDEMod:MERRor[:RESult]?

This command queries the magnitude error of the measured signal.

Prerequisites for this command

- Select FSK demodulation ([SENSe:] DDEMod).

Suffix:

<n> irrelevant

Return values:

<MagnitudeError> <numeric value>
Default unit: PCT

Example: //Query magnitude error
CALC:MARK:FUNC:DDEM:MERR?

Usage: Query only

CALCulate<n>:MARKer:FUNCtion:DDEMod:MINDEX[:RESult]?

This command queries the modulation index of the measured signal.

Prerequisites for this command

- Select ASK demodulation ([SENSe:] DDEMod).

Suffix:

<n> irrelevant

Return values:

<ModIndex> <numeric value>
Default unit: PCT

Example: //Query modulation index
CALC:MARK:FUNC:DDEM:MIND?

Usage: Query only

CALCulate<n>:MARKer:FUNCtion:DDEMod:MOERror[:RESult]?

This command queries the modulation error.

Suffix:

<n> irrelevant

Return values:

<ModError> <numeric value>
Default unit: PCT

Example: //Query modulation error
CALC:MARK:FUNC:DDEM:MOER?

Usage: Query only

CALCulate<n>:MARKer:FUNCTION:DDEMod:MPOWER[:RESult]?

This command queries the power of the carrier signal.

Suffix:
<n> irrelevant

Return values:
<Power> <numeric value>
Default unit: dBm

Example: //Query carrier power
CALC:MARK:FUNC:DDEM:MPOW?

Usage: Query only

[SENSe:]DDEMod <Measurement>

This command selects the demodulation scheme of the signal you are measuring.

Parameters:
<Measurement> **ASK**
Selects ASK modulation.
FSK
Selects FSK modulation.
*RST: FSK

Example: //Select measurement
DDEM ASK

Manual operation: See "ASK" on page 391
See "FSK" on page 391

[SENSe:]DDEMod:FSK:OFFSet?

This command queries the measured frequency deviation of an FSK signal.

Prerequisites for this command

- Select FSK demodulation ([SENSe:]DDEMod).

Return values:
<Frequency> <numeric value>
Default unit: Hz

Example: //Query frequency deviation
DDEM:FSK:OFFS?

Usage: Query only

TRACe[:DATA]?

This command queries the trace data (measurement results in graphical result displays).

Return values:

<Results> Returns one value for each measurement point.
The type of value depends on the measurement and result display.
"Symbols": returns the symbol stream.
"Modulation Deviation": returns one value (frequency deviation) for each symbol in Hz.
"Modulation Depth": returns one value (modulation depth) for each symbol in PCT.
"Modulation Error": returns one value for each symbol. The unit is either Hz (FSK) or PCT (ASK).

Example: //Query results
TRAC?

Usage: Query only

19.15.2 Measurement Configuration

[SENSe:]DDEMod:BURSt[:STATe].....	318
[SENSe:]DDEMod:FILTer:ALPHa.....	318
[SENSe:]DDEMod:FILTer:NAME.....	319
[SENSe:]DDEMod:FILTer[:STATe].....	319
[SENSe:]DDEMod:SRATe.....	320
[SENSe:]DDEMod:TIME.....	320

[SENSe:]DDEMod:BURSt[:STATe] <State>

This command turns burst processing on and off.

Parameters:

<State> ON | OFF | 1 | 0
*RST: OFF

Example: //Turn on burst processing
DDEM: BURS ON

Manual operation: See "[Demod Parameters](#)" on page 391

[SENSe:]DDEMod:FILTer:ALPHa <Alpha>

This command defines the roll-off factor of the measurement filter (alpha or BT value).

Parameters:

<Alpha> <numeric value>
 Range: 0 to 1
 *RST: 1

Example:

```
//Define roll-off factor
DDEM:FILT:ALPH 0.35
```

Manual operation: See ["Demod Parameters"](#) on page 391

[SENSe:]DDEMod:FILT:NAME <FilterType>

This command selects the measurement filter.

You can define the filter shape with [\[SENSe:\]DDEMod:FILT:ALPHa](#).

Parameters:

<FilterType> If you want to use no filter (unfiltered measurements), use [\[SENSe:\]DDEMod:FILT\[:STATe\]](#).

GAUS

Select a Gaussian filter.

RC

Select a raised cosine filter.

RRC

Selects a root raised cosine filter.

*RST: GAUS

Example:

```
//Select RRC filter
DDEM:FILT:NAME RRC
```

Manual operation: See ["Demod Parameters"](#) on page 391

[SENSe:]DDEMod:FILT[:STATe] <State>

This command turns the measurement filter on and off.

Parameters:

<State> **OFF | 0**
 Turns off the measurement filter for unfiltered measurements.

ON | 1
 Turns on the measurement filter selected with [\[SENSe:\]DDEMod:FILT:NAME](#).

*RST: ON

Example:

```
//Perform unfiltered measurement
DDEM:FILT OFF
```

Manual operation: See ["Demod Parameters"](#) on page 391

- Impedance:

INPut : IMPedance

INPut : IMPedance : PAD

DISPlay<n>[:WINDow]:TRACe<t>:Y[:SCALe]:PDIVision..... 321

DISPlay<n>[:WINDow]:TRACe<t>:Y[:SCALe]:RPOSition..... 321

DISPlay<n>[:WINDow]:TRACe<t>:Y[:SCALe]:PDIVision <Scale>

This command defines the range of the y-axis for the graphical results.

Suffix:

<n> irrelevant

<t> irrelevant

Parameters:

<Scale> <numeric value> (integer only)

The unit depends on the result.

- PCT for ASK results (1 % to 100 % per grid division).
- Hz for FSK results (1 kHz to 1 MHz per grid division).

Example: //Define grid scale of AM results (50 percent per grid)

```
CALC:FEED 'XTIM:DDEM:MEAS'
```

```
DISP:TRAC:Y:PDIV 50
```

Manual operation: See "[Deviation per Division](#)" on page 393

DISPlay<n>[:WINDow]:TRACe<t>:Y[:SCALe]:RPOSition <Position>

This command defines the position of the reference level on the display grid.

Prerequisites for this command

- Select ASK demodulation ([\[SENSe:\]DDEMod](#)).

Suffix:

<n> irrelevant

<t> irrelevant

Parameters:

<Position> <numeric value> (integer)

Range: 1 to 100

*RST: 100

Default unit: PCT

Example: //Define position of reference level

```
DDEM ASK
```

```
CALC:FEED 'XTIM:DDEM:MEAS'
```

```
DISP:TRAC:Y:RPOS 80
```

Manual operation: See "[Ref Position](#)" on page 393

19.15.5 Sweep Control

Commands to control the measurement described elsewhere.

- Measurement control:
`INITiate[:IMMEDIATE]`
- Measurement type (single / continuous):
`INITiate:CONTinuous`

19.15.6 Trigger

Commands to configure trigger described elsewhere.

- Trigger slope:
`TRIGger[:SEquence]:SLOPe`

<code>TRIGger[:SEquence]:LEVel:IQPower</code>	322
<code>TRIGger[:SEquence]:SOURce</code>	322

`TRIGger[:SEquence]:LEVel:IQPower` <Level>

This command defines the trigger level of the I/Q power trigger.

Prerequisites for this command

- Select I/Q power trigger (`TRIGger[:SEquence]:SOURce`).

Parameters:

<Level> <numeric value>
 *RST: -20
 Default unit: dBm

Example: //Configure I/Q power trigger
 TRIG:SOUR IQP
 TRIG:LEV:IQP -10

Manual operation: See "Trigger" on page 394

`TRIGger[:SEquence]:SOURce` <TriggerSource>

This command selects the trigger source.

Parameters:

<TriggerSource> **IMMEDIATE**
 No trigger is applied.

EXTERNAL
 Select an external trigger.

IQPower
 Select the I/Q power trigger.
 Define the trigger level with `TRIGger[:SEquence]:LEVel:IQPower`.

 *RST: IMMEDIATE

Example: //Select trigger source
TRIG:SOUR IMM

Manual operation: See "Trigger" on page 394

19.15.7 Marker

Commands to configure markers described elsewhere.

- Marker state (on / off):
CALCulate<n>:MARKer<m>[:STATe]
CALCulate<n>:MARKer<m>:AOFF
- Marker position:
CALCulate<n>:MARKer<m>:X
CALCulate<n>:MARKer<m>:Y?

Commands to configure delta markers described elsewhere.

- Delta marker state (on / off):
CALCulate<n>:DELTamarker<m>[:STATe]
CALCulate<n>:DELTamarker<m>:AOFF
- Delta marker position:
CALCulate<n>:DELTamarker<m>:X
- CALCulate<n>:DELTamarker<m>:X:RELative
- CALCulate<n>:DELTamarker<m>:Y?

19.16 Remote Commands of the VNA Application

• Measurement Configuration.....	323
• Amplitude.....	328
• Frequency.....	335
• Bandwidth.....	336
• Sweep.....	336
• Trace.....	337
• Marker.....	337
• Limit Lines.....	340

19.16.1 Measurement Configuration

• Measurements and Result Display.....	324
• DTF Configuration.....	325

Parameters:

<Format>

LOSS

Selects the cable loss format.

Available for cable loss measurements.

MAGNitude

Selects the return loss format.

Available for reflection and DTF measurements.

PHASe

Select the phase format.

Available for reflection measurements.

SMITH

Select the Smith chart format.

Available for reflection measurements.

VSWR

Selects the SWR format.

Available for reflection and DTF measurements.

Example:

//Select measurement format

MEAS:MODE REFL

MEAS:FORM VSWR

Manual operation: See "[Format](#)" on page 396**19.16.1.2 DTF Configuration**

CALCulate<n>:DTF:CABLE:PRESet.....	325
CALCulate<n>:DTF:DISTance:START.....	326
CALCulate<n>:DTF:DISTance:STOP.....	326
CALCulate<n>:TRANSform:DTFault:PEAK:COUNT?.....	326
CALCulate<n>:TRANSform:DTFault:PEAK:DATA<peak>?.....	327
CALCulate<n>:TRANSform:DTFault:PEAK[:STATe].....	327
CALCulate<n>:TRANSform:DTFault:PEAK:THReshold.....	328

CALCulate<n>:DTF:CABLE:PRESet <CableModel>

This command selects a cable model.

Prerequisites for this command

- Select the DTF measurement ([MEASurement<n>:MODE](#)).

Suffix:

<n> irrelevant

Parameters:

<CableModel> String containing the file name of the cable model.

Example:

//Select cable model

MEAS:MODE DTF

CALC:DTF:CAB:PRES '5088-HLFR.CBLMOD'

Manual operation: See "[Select Cable Model](#)" on page 397See "[Clear Cable Model](#)" on page 397

CALCulate<n>:DTF:DISTance:START <StartDistance>

This command defines the starting point (distance) of the DTF measurement.

Prerequisites for this command

- Select the DTF measurement ([MEASurement<n>:MODE](#)).

Suffix:

<n> irrelevant

Parameters:

<StartDistance> <numeric value>

The unit depends on your selection ([UNIT<n>:LENGTH](#)).

*RST: 0 m

Default unit: m or ft

Example:

//Define start distance for DTF measurement

UNIT:LENG MET

MEAS:MODE DTF

CALC:DTF:DIST:STAR 10

Manual operation: See ["Start Distance"](#) on page 398

CALCulate<n>:DTF:DISTance:STOP <StopDistance>

This command defines the end point (distance) of the DTF measurement.

Prerequisites for this command

- Select the DTF measurement ([MEASurement<n>:MODE](#)).

Suffix:

<n> irrelevant

Parameters:

<StopDistance> <numeric value>

The unit depends on your selection ([UNIT<n>:LENGTH](#)).

*RST: 50 m

Default unit: m or ft

Example:

//Define stop distance for DTF measurement

UNIT:LENG MET

MEAS:MODE DTF

CALC:DTF:DIST:STOP 100

Manual operation: See ["Stop Distance"](#) on page 398

CALCulate<n>:TRANSform:DTFault:PEAK:COUNt? <State>

This command queries the number of entries in the DTF list.

Prerequisites for this command

- Select the DTF measurement ([MEASurement<n>:MODE](#)).

Suffix:	
<n>	irrelevant
Return values:	
<Peaks>	<numeric value>
Example:	//Query number of entries in the DTF list MEAS:MODE DTF CALC:TRAN:DTF:PEAK:COUN?
Usage:	Query only

CALCulate<n>:TRANSform:DTFault:PEAK:DATA<peak>?

This command queries the DTF list.

Prerequisites for this command

- Select the DTF measurement ([MEASurement<n>:MODE](#)).

Suffix:	
<n>	irrelevant
<peak>	Selects an entry in the DTF list. The range depends on the number of DTF list entries. You can query the number of entries with CALCulate<n>:TRANSform:DTFault:PEAK:COUNt? .

Return values:	
<Distance>, <ReturnLoss>	<numeric value> The first value represents the distance to the fault, the second value the return loss measured at that distance.

Example: //Query second DTF list entry
MEAS:MODE DTF
CALC:TRAN:DTF:PEAK:DATA2?

Usage: Query only

CALCulate<n>:TRANSform:DTFault:PEAK[:STATe] <State>

This command turns the display of the DTF list on and off.

Prerequisites for this command

- Select the DTF measurement ([MEASurement<n>:MODE](#)).

Suffix:	
<n>	irrelevant
Parameters:	
<State>	ON OFF 1 0 *RST: OFF

Example: //Activate DTF list
 MEAS:MODE DTF
 CALC:TRAN:DTF:PEAK ON

Manual operation: See "DTF List" on page 397

CALCulate<n>:TRANSform:DTFault:PEAK:THReshold <Threshold>

This command defines a threshold for the DTF list. Only peaks above that threshold will appear in the DTF list.

Prerequisites for this command

- Select the DTF measurement ([MEASurement<n>:MODE](#)).

Suffix:

<n> irrelevant

Parameters:

<Threshold> <numeric value>

The unit depends on the measurement format (dB for return loss, no unit for SWR).

*RST: 0

Example: //Define threshold for DTF list
 MEAS:MODE DTF
 CALC:TRAN:DTF:PEAK:THR -10

Manual operation: See "DTF List Threshold" on page 397

19.16.2 Amplitude

Commands to configure amplitude described elsewhere.

- Auto Range:
[DISPlay<n>\[:WINDow\]:TRACe<t>:Y\[:SCALe\]:ADJust](#)

DISPlay<n>:LOSS:REFerence	329
DISPlay<n>:LOSS:REFerence:POSition	329
DISPlay<n>:LOSS:Y:SCALe	329
DISPlay<n>:MAGNitude:REFerence	330
DISPlay<n>:MAGNitude:REFerence:POSition	330
DISPlay<n>:MAGNitude:Y:SCALe	331
DISPlay<n>:MAGNitude:Y:SPACing	331
DISPlay<n>:PHASe:REFerence	332
DISPlay<n>:PHASe:REFerence:POSition	332
DISPlay<n>:PHASe:UNWRap	333
DISPlay<n>:PHASe:Y:SCALe	333
DISPlay<n>:VSWR:Y:SCALe	334
DISPlay<n>:VSWR:Y:SCALe:MAXimum	334
DISPlay<n>:VSWR:Y:SCALe:MINimum	335

DISPlay<n>:LOSS:REfERENCE <RefValue>

This command defines the reference value for the cable loss measurement format.

Prerequisites for this command

- Select cable loss measurement (`MEASurement<n>:MODE`).
- Select cable loss format (`MEASurement<n>:FORMat`).

Suffix:

<n> irrelevant

Parameters:

<RefValue> <numeric value>
 *RST: 0
 Default unit: dB

Example:

```
//Define reference value for cable loss
MEAS:MODE LOSS
MEAS:FORM LOSS
DISP:LOSS:REF 50
```

Manual operation: See ["Reference Level"](#) on page 399

DISPlay<n>:LOSS:REfERENCE:POSition <RefPosition>

This command defines the position of the reference value for the cable loss measurement format.

Each step shifts the reference position one grid line up or down.

Prerequisites for this command

- Select cable loss measurement (`MEASurement<n>:MODE`).
- Select cable loss format (`MEASurement<n>:FORMat`).

Suffix:

<n> irrelevant

Parameters:

<RefPosition> <numeric value> (integer only)
 *RST: 8

Example:

```
//Define 5th grid line as the reference position for cable loss
MEAS:MODE LOSS
MEAS:FORM LOSS
DISP:LOSS:REF:POS 5
```

Manual operation: See ["Range / Ref Position"](#) on page 399

DISPlay<n>:LOSS:Y:SCALE <DisplayRange>

This command defines the range of the y-axis for the cable loss measurement format.

Prerequisites for this command

- Select cable loss measurement ([MEASurement<n>:MODE](#)).
- Select cable loss format ([MEASurement<n>:FORMat](#)).

Suffix:

<n> irrelevant

Parameters:

<DisplayRange> <numeric value>
 *RST: 100
 Default unit: dB

Example: //Define display range for cable loss
 MEAS:MODE LOSS
 MEAS:FORM LOSS
 DISP:LOSS:Y:SCAL 50

Manual operation: See "[Range / Ref Position](#)" on page 399

DISPlay<n>:MAGNitude:REFerence <RefValue>

This command defines the reference value for the return loss measurement format.

Prerequisites for this command

- Select reflection, transmission or DTF measurement ([MEASurement<n>:MODE](#)).
- Select return loss format ([MEASurement<n>:FORMat](#)).

Suffix:

<n> irrelevant

Parameters:

<RefValue> <numeric value>
 *RST: 0
 Default unit: dB or %

Example: //Define reference value for return loss
 MEAS:MODE REFL
 MEAS:FORM MAGN
 DISP:MAGN:REF 50

Manual operation: See "[Reference Level](#)" on page 399

DISPlay<n>:MAGNitude:REFerence:POSition <RefPosition>

This command defines the position of the reference value for the return loss measurement format.

Each step shifts the reference position one grid line up or down.

Prerequisites for this command

- Select reflection, transmission or DTF measurement ([MEASurement<n>:MODE](#)).
- Select return loss format ([MEASurement<n>:FORMat](#)).

Suffix:

<n> irrelevant

Parameters:

<RefPosition> <numeric value> (integer only)

*RST: 8

Example:

```
//Define 5th grid line as the reference position for return loss
MEAS:MODE REFL
MEAS:FORM MAGN
DISP:MAGN:REF:POS 5
```

Manual operation: See "[Range / Ref Position](#)" on page 399

DISPlay<n>:MAGNitude:Y:SCALe <DisplayRange>

This command defines the range of the y-axis for the return loss measurement format.

Prerequisites for this command

- Select reflection, transmission or DTF measurement ([MEASurement<n>:MODE](#)).
- Select return loss format ([MEASurement<n>:FORMat](#)).
- Select a logarithmic scale ([DISPlay<n>:MAGNitude:Y:SPACing](#)).
(For a linear scale, the range is always 100 %.)

Suffix:

<n> irrelevant

Parameters:

<DisplayRange> <numeric value>

*RST: 100

Default unit: dB

Example:

```
//Define display range for return loss
MEAS:MODE REFL
MEAS:FORM MAGN
DISP:MAGN:Y:SPAC LOG
DISP:MAGN:Y:SCAL 50
```

Manual operation: See "[Range / Ref Position](#)" on page 399

DISPlay<n>:MAGNitude:Y:SPACing <Scaling>

This command selects scaling of the y-axis for the return loss measurement format.

Prerequisites for this command

- Select reflection, transmission or DTF measurement ([MEASurement<n>:MODE](#)).
- Select return loss format ([MEASurement<n>:FORMat](#)).

Suffix:

<n> irrelevant

Parameters:

<Scaling>

LINear

Selects a linear scale (in %).

LOGarithmic

Selects a logarithmic scale (in dB).

*RST: LOGarithmic

Example:

```
//Select scaling of the y-axis
MEAS:MODE REFL
MEAS:FORM MAGN
DISP:MAGN:Y:SPAC LIN
```

Manual operation: See "[Range / Ref Position](#)" on page 399**DISPlay<n>:PHASe:REFerence <RefValue>**

This command defines the reference value for the phase measurement format.

Prerequisites for this command

- Select reflection measurement ([MEASurement<n>:MODE](#)).
- Select phase format ([MEASurement<n>:FORMat](#)).

Suffix:

<n> irrelevant

Parameters:

<RefValue> <numeric value>

Range: -100000 to 100000

*RST: 0

Default unit: deg

Example:

```
//Define reference value for phase
MEAS:MODE REFL
MEAS:FORM PHAS
DISP:PHAS:REF 360
```

Manual operation: See "[Reference Level](#)" on page 399**DISPlay<n>:PHASe:REFerence:POSition <RefPosition>**

This command defines the position of the reference value for the phase measurement format.

Each step shifts the reference position one grid line up or down.

Prerequisites for this command

- Select reflection measurement ([MEASurement<n>:MODE](#)).
- Select phase format ([MEASurement<n>:FORMat](#)).

Suffix:

<n> irrelevant

Parameters:

<RefPosition> <numeric value> (integer only)

Range: 0 to 10

*RST: 8

Example:

```
//Define 5th grid line as the reference position for phase format
MEAS:MODE REFL
MEAS:FORM PHAS
DISP:PHAS:REF:POS 5
```

Manual operation: See "[Range / Ref Position](#)" on page 399

DISPlay<n>:PHASe:UNWRap <State>

This command removes the restriction limiting the value range to +/- 180°.

Suffix:

<n> irrelevant

Parameters:

<State> ON | OFF | 1 | 0

*RST: OFF

Example:

```
//Unwrap phase
DISP:PHAS:UNWR ON
```

Manual operation: See "[Phase](#)" on page 397

DISPlay<n>:PHASe:Y:SCALe <DisplayRange>

This command defines the range of the y-axis for the phase measurement format.

Prerequisites for this command

- Select reflection measurement ([MEASurement<n>:MODE](#)).
- Select phase format ([MEASurement<n>:FORMat](#)).

Suffix:

<n> irrelevant

Parameters:

<DisplayRange> <numeric value>

The number you enter is rounded up to the next possible display range. For example, if you enter 300°, the R&S FPC automatically sets the display range to 360°.

Range: 90 to 100000

*RST: 360

Default unit: deg

Example:

```
//Define display range for phase
MEAS:MODE REFL
MEAS:FORM PHAS
DISP:PHAS:Y:SCAL 180
```

Manual operation: See "[Range / Ref Position](#)" on page 399

DISPlay<n>:VSWR:Y:SCALe <DisplayRange>

This command defines the range of the y-axis for the SWR measurement format.

Prerequisites for this command

- Select reflection or DTF measurement (`MEASurement<n>:MODE`).
- Select SWR format (`MEASurement<n>:FORMat`).

Suffix:

<n> irrelevant

Parameters:

<DisplayRange> <numeric value>

The number you enter is rounded up to the next possible display range. For example, if you enter 5, the R&S FPC selects a display range 1...6.

Range: 1.1 to 71

*RST: 1...21

Default unit: dB

Example: //Define display range for SWR (1...71)

```
MEAS:MODE DTF
```

```
MEAS:FORM VSWR
```

```
DISP:VSWR:Y:SCAL 50
```

Manual operation: See "[Range / Ref Position](#)" on page 399

DISPlay<n>:VSWR:Y:SCALE:MAXimum <TopValue>

This command defines the top value of the vertical axis for the SWR measurement format.

Prerequisites for this command

- Select reflection or DTF measurement (`MEASurement<n>:MODE`).
- Select SWR format (`MEASurement<n>:FORMat`).

Suffix:

<n> irrelevant

Parameters:

<TopValue> <numeric value>

Range: 1.1 to 71

Example: //Define upper value of the y-axis in SWR

```
MEAS:MODE DTF
```

```
MEAS:FORM VSWR
```

```
DISP:VSWR:Y:SCALE:MAX 25
```

Manual operation: See "[Range / Ref Position](#)" on page 399

DISPlay<n>:VSWR:Y:SCALe:MINimum <BottomValue>

This command defines the top value of the vertical axis for the SWR measurement format.

Prerequisites for this command

- Select reflection or DTF measurement (`MEASurement<n>:MODE`).
- Select SWR format (`MEASurement<n>:FORMat`).

Suffix:

<n> irrelevant

Parameters:

<BottomValue> <numeric value>
Range: 1.1 to 71

Example:

```
//Define lower value of the y-axis in SWR
MEAS:MODE DTF
MEAS:FORM VSWR
DISP:VSWR:Y:SCAL:MIN 1
```

Manual operation: See "[Range / Ref Position](#)" on page 399

19.16.3 Frequency

Commands to configure the frequency described elsewhere.

- Center frequency:
`[SENSe:]FREQuency:CENTer`
- Span:
`[SENSe:]FREQuency:SPAN`
- Start frequency:
`[SENSe:]FREQuency:START`
- Stop frequency:
`[SENSe:]FREQuency:STOP`
- Frequency mode (frequency / channel):
`[SENSe:]FREQuency:INPut:MODE`
- Channel selection:
`[SENSe:]CHANnel`

`[SENSe:]FREQuency:SETTings:COUPling:ENABLE`..... 335
`[SENSe:]FREQuency:SPAN:AUTO`..... 336

[SENSe:]FREQuency:SETTings:COUPling:ENABLE <State>

This command couples or decouples the frequency settings of the DTF measurement to the other VNA measurements.

Parameters:

<State>

ON | 1

Frequency settings are coupled. When you change the frequency or span in the DTF measurement, they also change in the other VNA measurements (reflection, transmission and cable loss).

OFF | 0

Frequency settings of the DTF measurement are independent. When you change the frequency or span in the DTF measurement, they do not change in the other VNA measurements (reflection, transmission and cable loss).

*RST: ON

Example:

```
//Decouple frequency and span
FREQ:SETT:COUP:ENAB OFF
```

Manual operation: See "[Coupled Span](#)" on page 399

[SENSe:]FREQuency:SPAN:AUTO <State>

This command turns the automatic calculation of the ideal span on and off.

Parameters:

<State>

ON | OFF | 1 | 0

*RST: OFF | 0

Example:

```
//Turn on automatic span
FREQ:SPAN:AUTO ON
```

Manual operation: See "[Manual Span](#)" on page 369
See "[Manual Span](#)" on page 399

19.16.4 Bandwidth

Commands to configure the bandwidth described elsewhere.

- Resolution bandwidth:

```
[SENSe:]BANDwidth[:RESolution]
[SENSe:]BANDwidth[:RESolution]:AUTO
```

19.16.5 Sweep

Commands to configure the sweep described elsewhere.

- Sweep mode:

```
INITiate:CONTinuous
```
- Initiate measurement:

```
INITiate[:IMMediate]
```

[SENSe:]SWEep:POINts.....337

[SENSe:]SWEep:POINts <SweepPoints>

This command defines the number of measurement points.

Parameters:

<SweepPoints> <numeric value> (integer only)
 Range: 101 to 2501
 *RST: 201

Example: //Define number of measurement points
 SWE:POIN 1001

Manual operation: See "Number of Points" on page 401

19.16.6 Trace

Commands to configure traces described elsewhere.

- Trace mode:
`DISPlay<n>[:WINDow]:TRACe<t>:MODE`
 Note: Only "Clear/Write" and "Average" are supported by the VNA application.
- Memory trace:
`CALCulate<n>:MATH<t>:COPY:MEMory`
`DISPlay<n>[:WINDow]:TRACe<t>:MEMory[:STATe]`
- Data format of trace export:
`FORMat[:DATA]`

`TRACe[:DATA]?`..... 337

TRACe[:DATA]?

This command queries the trace data (measurement results in graphical result displays).

Return values:

<Result> The number of values depends on the number of measurement points.
 The unit depends on the measurement and the measurement format.

Example: //Query measurement results
 TRAC?

Usage: Query only

19.16.7 Marker

Commands to configure markers described elsewhere.

- Marker state (on / off):
`CALCulate<n>:MARKer<m>[:STATe]`
`CALCulate<n>:MARKer<m>:AOFF`

- Marker position:
CALCulate<n>:MARKer<m>:X
CALCulate<n>:MARKer<m>:Y?
- Marker position: set to peak:
CALCulate<n>:MARKer<m>:MAXimum[:PEAK]
- Marker position: set to next peak:
CALCulate<n>:MARKer<m>:MAXimum:NEXT
- Marker position: set to minimum:
CALCulate<n>:MARKer<m>:MINimum[:PEAK]

Commands to configure delta markers described elsewhere.

- Delta marker state (on / off):
CALCulate<n>:DELTamarker<m>[:STATE]
CALCulate<n>:DELTamarker<m>:AOFF
- Delta marker position:
CALCulate<n>:DELTamarker<m>:X
- CALCulate<n>:DELTamarker<m>:X:RELative
- CALCulate<n>:DELTamarker<m>:Y?
- Delta marker position: set to peak:
CALCulate<n>:DELTamarker<m>:MAXimum[:PEAK]
- Delta marker position: set to next peak:
CALCulate<n>:DELTamarker<m>:MAXimum:NEXT
- Delta marker position: set to minimum:
CALCulate<n>:DELTamarker<m>:MINimum[:PEAK]

CALCulate<n>:MARKer<m>:MODE.....338
 CALCulate<n>:MARKer<m>:Y?.....339
 DISPLAY<n>:IMPedance:REFerence:POSition.....340

CALCulate<n>:MARKer<m>:MODE <MarkerMode>

This command selects the type of information a marker shows.

Suffix:

- <n> irrelevant
- <m> irrelevant

Parameters:

- <MarkerMode> See table below for supported parameters.
*RST: NORMal

Manual operation: See "Marker Mode" on page 403

ADMittance	admittance in complex format (real + imaginary)
IMPedance	impedance in complex format (real + imaginary)

NADMittance	standardized admittance in complex format (real + imaginary)
NIMPedance	standardized impedance in complex format (real + imaginary)
NORMal	normal marker
RPDB	reflection coefficient in complex format (magnitude (dB) + phase)
RPL	reflection coefficient in complex format (magnitude (lin) + phase)
RSCalar	reflection coefficient in complex format (real + imaginary)

CALCulate<n>:MARKer<m>:Y?

This command queries the measurement results at the marker position.

If necessary, the corresponding marker is activated first.

To get a valid result, you have to perform a complete sweep with synchronization to the sweep end between activating the delta marker and reading out the result. This is only possible in single sweep mode.

Suffix:

<n> irrelevant

<m> [Marker](#)

Return values:

<Position> <numeric value>

The unit of the return value depends on the measurement mode and format you have selected.

In the Smith chart, the return value also depends on the marker format you have selected with [CALCulate<n>:MARKer<m>:MODE](#).

Example:

```
//Turn on single sweep mode and marker 2
INIT:CONT OFF
CALC:MARK2 ON
//Start a sweep and wait for the end
INIT;*WAI
//Query the position of marker 2
CALC:MARK2:X?
CALC:MARK2:Y?
```

Usage: Query only

Manual operation: See "[Marker <x>](#)" on page 403

DISPlay<n>:IMPedance:REfERENCE:POSition <Impedance>

This command defines the reference impedance for the Smith chart measurement format. The impedance can be between 1mΩ and 10 kΩ.

Prerequisites for this command

- Select reflection measurement (`MEASurement<n>:MODE`).
- Select Smith chart format (`MEASurement<n>:FORMat`).

Suffix:

<n> irrelevant

Parameters:

<Impedance> <numeric value>
 Range: 1 mOhm to 10 kOhm
 *RST: 50 Ohm
 Default unit: Ohm

Example: //Define reference impedance
 MEAS:MODE REFL
 MEAS:FORM SMIT
 DISP:IMP:REF:POS

Manual operation: See "[Marker Mode](#)" on page 403

19.16.8 Limit Lines

Commands to configure limit lines described elsewhere.

- Display lines:
`CALCulate<n>:DLINe`
`CALCulate<n>:DLINe:STATe`
- Limit line management:
`CALCulate<n>:LIMit<k>:COMMeNt?`
`CALCulate<n>:LIMit<k>:DEFine`
`CALCulate<n>:LIMit<k>:DELete`
`CALCulate<n>:LIMit<k>:UNIT:X?`
`CALCulate<n>:LIMit<k>:UNIT[:Y]?`
- Limit checks:
`CALCulate<n>:LIMit<k>:BEEP[:STATe]`
`CALCulate<n>:LIMit<k>:FAIL?`
`CALCulate<n>:LIMit<k>:LOWer:SElect`
`CALCulate<n>:LIMit<k>:STATe`
`CALCulate<n>:LIMit<k>:UPPer:SElect`
- Threshold lines:
`CALCulate<n>:LIMit<k>:LOWer:THReshold`
`CALCulate<n>:LIMit<k>:UPPer:THReshold`

19.17 Status Reporting System

The status reporting system stores all information about the present operating state of the instrument, including errors that have occurred. The R&S FPC stores this information in the status registers and in the error queue. You can query the contents of the status registers and the error queue via a remote control connection.

The information is of a hierarchical structure.

The status byte register (STB), defined in IEEE 488.2, and its associated service request enable (SRE) mask register represent the highest level.

The STB receives its information from the next higher level. This level contains the standard event status register (ESR), also defined in IEEE 488.2, and its associated standard event status enable (ESE) mask register. The STB also receives information from the `STATUS:OPERation` and `STATUS:QUESTionable` registers. The latter contain detailed information about the instrument state and are defined in the SCPI standard.

The output buffer contains the messages the instrument returns to the controller. It is not part of the status reporting system but determines the value of the MAV bit in the STB.

• Structure of a SCPI Status Register	341
• Overview of the Status Registers	344
• Status Byte (STB) and Service Request Enable Register (SRE)	344
• Event Status Register (ESR) and Event Status Enable Register (ESE)	345
• STATUS:OPERation Register	346
• STATUS:QUESTionable Register	346
• STATUS:QUESTionable:FREQuency Register	347
• STATUS:QUESTionable:LIMit Register	347
• STATUS:QUESTionable:POWer Register	348
• Application of the Status Reporting Systems	348
• Reset Values of the Status Reporting System	349
• Remote Commands of the Status Reporting System	350

19.17.1 Structure of a SCPI Status Register

Each standard SCPI register contains 5 parts each of which have a width of 16 bits and have different functions. The individual bits are independent of each other, that means each hardware status is assigned a bit number that applies to all five parts. For example, bit 9 of the `STATUS:QUESTionable` register is assigned to the power characteristics of the R&S FPC. Bit 15 (the most significant bit) is set to zero for all parts. Thus the contents of the register parts can be processed by the controller as positive integer.

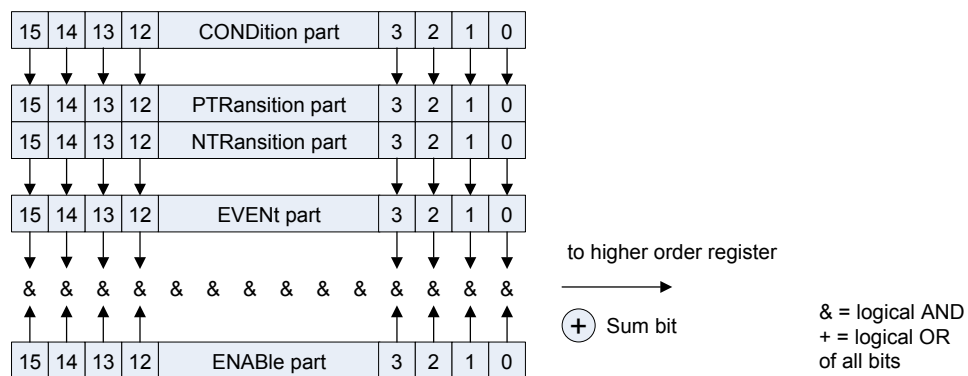

Figure 19-5: Model of the status register

CONDition part

The CONDition part is directly written into by the hardware or the sum bit of the next lower register. Its contents reflects the current instrument status. This register part can only be read, but not written into or cleared. Its contents is not affected by reading.

PTRansition part

The Positive-Transition (PTR) part acts as an edge detector. When a bit of the CONDition part is changed from 0 to 1, the associated PTR bit decides whether the EVENT bit is set to 1.

PTR bit = 1: the EVENT bit is set.

PTR bit = 0: the EVENT bit is not set.

This part can be written into and read at will. Its contents is not affected by reading.

NTRansition part

The Negative-Transition (NTR) part also acts as an edge detector. When a bit of the CONDition part is changed from 1 to 0, the associated NTR bit decides whether the EVENT bit is set to 1.

NTR-Bit = 1: the EVENT bit is set.

NTR-Bit = 0: the EVENT bit is not set.

This part can be written into and read at will. Its contents is not affected by reading.

With these two edge register parts the user can define which state transition of the condition part (none, 0 to 1, 1 to 0 or both) is stored in the EVENT part.

EVENT part

The EVENT part indicates whether an event has occurred since the last reading, it is the "memory" of the condition part. It only indicates events passed on by the edge filters. It is permanently updated by the instrument. This part can only be read by the user. Reading the register clears it. This part is often equated with the entire register.

ENABLE part

The `ENABLE` part determines whether the associated `EVENT` bit contributes to the sum bit (see below). Each bit of the `EVENT` part is `ANDed` with the associated `ENABLE` bit (symbol '&'). The results of all logical operations of this part are passed on to the sum bit via an `OR` function (symbol '+').

ENABLE-Bit = 0: the associated `EVENT` bit does not contribute to the sum bit.

ENABLE-Bit = 1: if the associated `EVENT` bit is "1", the sum bit is set to "1" as well.

This part can be written into and read by the user at will. Its contents is not affected by reading.

Sum bit

As indicated above, the sum bit is obtained from the `EVENT` and `ENABLE` part for each register. The result is then entered into a bit of the `CONDition` part of the higher-order register.

The instrument automatically generates the sum bit for each register. Thus an event, e.g. a PLL that has not locked, can lead to a service request throughout all levels of the hierarchy.



The service request enable register `SRE` defined in IEEE 488.2 can be taken as `ENABLE` part of the `STB` if the `STB` is structured according to SCPI. Analogous, the `ESE` can be taken as the `ENABLE` part of the `ESR`.

19.17.2 Overview of the Status Registers

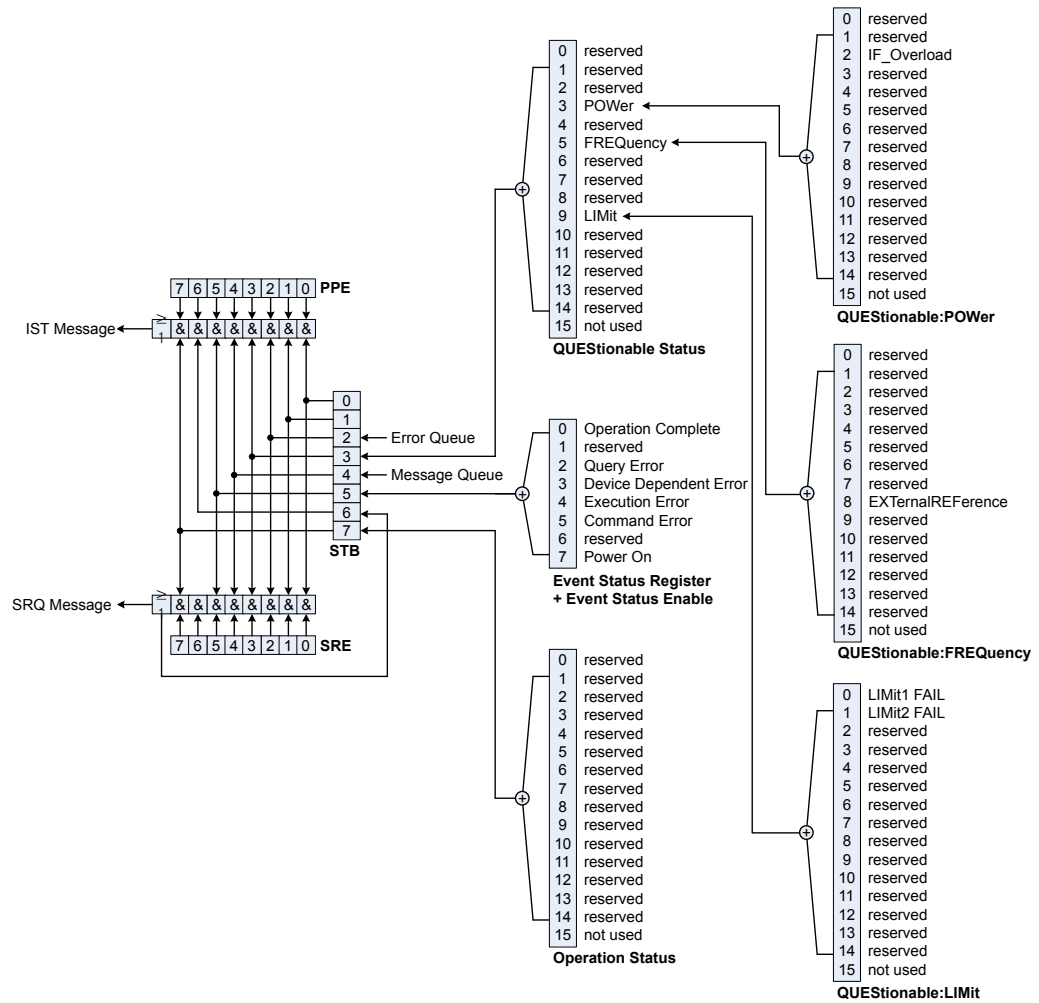

Figure 19-6: Overview of the status registers

19.17.3 Status Byte (STB) and Service Request Enable Register (SRE)

The `STB` is already defined in IEEE 488.2. It provides a rough overview of the instrument status by collecting the pieces of information of the lower registers. It can thus be compared with the `CONDition` part of an SCPI register and assumes the highest level within the SCPI hierarchy. A special feature is that bit 6 acts as the sum bit of the remaining bits of the status byte.

The `STATUS BYTE` is read using the command `*STB?` or a serial poll.

The `STB` is linked to the `SRE`. The latter corresponds to the `ENABLE` part of the SCPI registers in its function. Each bit of the `STB` is assigned a bit in the `SRE`. Bit 6 of the `SRE` is ignored. If a bit is set in the `SRE` and the associated bit in the `STB` changes from 0 to 1, a service request (SRQ) is generated, which triggers an interrupt in the control-

ler if this is appropriately configured and can be further processed there. The `SRE` can be set using the command `*SRE` and read using the command `*SRE?`.

Table 19-8: Meaning of the bits used in the status byte

Bit number	Meaning
0 to 1	Unused
2	<p>Error Queue not empty</p> <p>The bit is set when an entry is made in the error queue. If this bit is enabled by the <code>SRE</code>, each entry of the error queue generates a service request. Thus an error can be recognized and specified in greater detail by polling the error queue. The poll provides an informative error message. This procedure is to be recommended since it considerably reduces the problems involved with remote control.</p>
3	<p>QUESTIONable status sum bit</p> <p>The bit is set if an <code>EVENT</code> bit is set in the <code>QUESTIONable</code> status register and the associated <code>ENABLE</code> bit is set to 1.</p> <p>A set bit indicates a questionable instrument status, which can be specified in greater detail by polling the <code>QUESTIONable</code> status register.</p>
4	<p>MAV bit (message available)</p> <p>The bit is set if a message is available in the output buffer which can be read. This bit can be used to enable data to be automatically read from the instrument to the controller.</p>
5	<p>ESB bit</p> <p>Sum bit of the event status register. It is set if one of the bits in the event status register is set and enabled in the event status enable register.</p> <p>Setting of this bit indicates a serious error which can be specified in greater detail by polling the event status register.</p>
6	<p>MSS bit (master status summary bit)</p> <p>The bit is set if the instrument triggers a service request. This is the case if one of the other bits of this register is set together with its mask bit in the service request enable register <code>SRE</code>.</p>
7	<p>OPERation status register sum bit</p> <p>The bit is set if an <code>EVENT</code> bit is set in the <code>OPERation</code> status register and the associated <code>ENABLE</code> bit is set to 1.</p> <p>A set bit indicates that the instrument is just performing an action. The type of action can be determined by polling the <code>OPERation</code> status register.</p>

19.17.4 Event Status Register (ESR) and Event Status Enable Register (ESE)

The `ESR` is defined in IEEE 488.2. It can be compared with the `EVENT` part of a SCPI register. The event status register can be read out using command `*ESR?`.

The `ESE` is the associated `ENABLE` part. It can be set using the command `*ESE` and read using the command `*ESE?`.

Table 19-9: Meaning of the bits in the event status register

Bit number	Meaning
0	Operation Complete This bit is set on receipt of the command *OPC exactly when all previous commands have been executed.
1	Unused
2	Query Error This bit is set if either the controller wants to read data from the instrument without having sent a query, or if it does not fetch requested data and sends new instructions to the instrument instead. The cause is often a query which is faulty and hence cannot be executed.
3	Device-dependent Error This bit is set if a device-dependent error occurs. An error message with a number between -300 and -399 or a positive error number, which denotes the error in greater detail, is entered into the error queue.
4	Execution Error This bit is set if a received command is syntactically correct but cannot be performed for other reasons. An error message with a number between -200 and -300, which denotes the error in greater detail, is entered into the error queue.
5	Command Error This bit is set if a command is received, which is undefined or syntactically incorrect. An error message with a number between -100 and -200, which denotes the error in greater detail, is entered into the error queue.
6	Unused
7	Power On (supply voltage on) This bit is set on switching on the instrument.

19.17.5 STATus:OPERation Register

In the CONDition part, this register contains information on which actions the instrument is being executing or, in the EVENT part, information on which actions the instrument has executed since the last reading. It can be read using the commands STATus:OPERation:CONDition? or STATus:OPERation[:EVENT]?

Table 19-10: Meaning of the bits in the STATus:OPERation register

Bit number	Meaning
0 to 14	Unused
15	This bit is always 0.

19.17.6 STATus:QUEStionable Register

This register contains information about indefinite states which may occur if the unit is operated without meeting the specifications. It can be read using the commands STATus:QUEStionable:CONDition? and STATus:QUEStionable[:EVENT]?

Table 19-11: Meaning of bits in `STATUS:QUESTIONable` register

Bit number	Meaning
0 to 2	Unused
3	POWER This bit is set if the measured power level in any of the active channels is questionable.
4	Unused
5	FREQUENCY This bit is set if there is anything wrong with the frequency of the local oscillator or the reference frequency in any of the active channels.
6 to 8	Unused
9	LIMIT (device-specific) This bit is set if a limit value is violated.
10 to 14	Unused
15	This bit is always 0.

19.17.7 `STATUS:QUESTIONable:FREQUENCY` Register

This register contains information about the reference frequency. It can be read using the commands `STATUS:QUESTIONable:LIMIT:FREQUENCY?` and `STATUS:QUESTIONable:FREQUENCY[:EVENT]?`.

Table 19-12: Meaning of bits in `STATUS:QUESTIONable:FREQUENCY` register

Bit number	Meaning
0 to 7	Unused
8	EXTERNAL REFERENCE This bit is set if an external reference is used.
9 to 14	Unused
15	This bit is always 0.

19.17.8 `STATUS:QUESTIONable:LIMIT` Register

This register contains information about the observance of limit lines. It can be read using the commands `STATUS:QUESTIONable:LIMIT:CONDITION?` and `STATUS:QUESTIONable:LIMIT[:EVENT]?`.

Table 19-13: Meaning of bits in `STATUS:QUESTIONable:LIMIT` register

Bit number	Meaning
0	LIMIT 1 FAIL This bit is set if limit line 1 is violated.
1	LIMIT 2 FAIL This bit is set if limit line 2 is violated.

Bit number	Meaning
2 to 14	Unused
15	This bit is always 0.

19.17.9 STATUS:QUESTIONABLE:POWER Register

This register contains information about possible overload states. It can be read using the commands `STATUS:QUESTIONABLE:POWER:CONDITION?` and `STATUS:QUESTIONABLE:POWER[:EVENT]?`.

Table 19-14: Meaning of bits in STATUS:QUESTIONABLE:POWER register

Bit number	Meaning
0 to 1	Unused
2	IF_Overload This bit is set if the IF path is overloaded. 'IFOVL' is displayed.
3 to 14	Unused
15	This bit is always 0.

19.17.10 Application of the Status Reporting Systems

In order to be able to effectively use the status reporting system, the information contained there must be transmitted to the controller and further processed there. There are several methods which are represented in the following.

Service request

Under certain circumstances, the instrument can send a service request (SRQ) to the controller. Usually this service request initiates an interrupt at the controller, to which the control program can react appropriately. As evident from Fig. 1-4, an SRQ is always initiated if one or several of bits 2, 3, 4, 5 or 7 of the status byte are set and enabled in the SRE. Each of these bits combines the information of a further register, the error queue or the output buffer. The ENABLE parts of the status registers can be set so that arbitrary bits in an arbitrary status register initiate an SRQ. In order to make use of the possibilities of the service request effectively, all bits should be set to "1" in enable registers SRE and ESE.

Example:

Use of the command `*OPC` to generate an SRQ at the end of a sweep.

```
//Set bit 0 in the ESE (Operation Complete)
CALL InstrWrite(analyzer, "*ESE 1")
//Set bit 5 in the SRE (ESB)
CALL InstrWrite(analyzer, "*SRE 32")
```

After its settings have been completed, the instrument generates an SRQ.

The SRQ is the only possibility for the instrument to become active on its own. Each controller program should set the instrument in a way that a service request is initiated in the case of malfunction. The program should react appropriately to the service request.

Serial poll

In a serial poll, just as with command `*STB`, the status byte of an instrument is queried. However, the query is realized via interface messages and is thus clearly faster. The serial-poll method has already been defined in IEEE 488.1 and used to be the only standard possibility for different instruments to poll the status byte. The method also works with instruments which do not adhere to SCPI or IEEE 488.2.

Serial poll is mainly used to obtain a fast overview of the state of several instruments connected to the controller.

Query by means of commands

Each part of any status register can be read by means of queries. The individual commands are listed in the description of the STATUS Subsystem. The returned value is always a number that represents the bit pattern of the queried register. This number is evaluated by the controller program.

Queries are usually used after an SRQ in order to obtain more detailed information on the cause of the SRQ.

Error queue query

Each error state in the instrument leads to an entry in the error queue. The entries of the error queue are detailed plain-text error messages that can be displayed via manual operation using the setup menu or queried via remote control using the command `SYSTEM:ERROR?`. Each call of `SYSTEM:ERROR?` provides one entry from the error queue. If no error messages are stored there any more, the instrument responds with 0, "No error".

The error queue should be queried after every SRQ in the controller program as the entries describe the cause of an error more precisely than the status registers. Especially in the test phase of a controller program the error queue should be queried regularly since faulty commands from the controller to the instrument are recorded there as well.

19.17.11 Reset Values of the Status Reporting System

Various commands and events initiate a reset of the status reporting system. None of the commands, except `*RST` and `SYSTEM:PRESet`, influence the functional instrument settings. In particular, `DCL` does not change the instrument settings.

Table 19-15: Resetting the status reporting system

Event	Switching on supply voltage		DCL, SDC (Device Clear, Selected Device Clear)	*RST or SYS-Tem:PRE Set	STA-Tus:PRE-Set	*CLS
	Power-On-Status-Clear					
Effect	0	1				
Clear STB, ESR	-	yes	-	-	-	yes
Clear SRE, ESE	-	yes	-	-	-	-
Clear PPE	-	yes	-	-	-	-
Clear EVENT parts of the registers	-	yes	-	-	-	yes
Clear ENABLE parts of all OPERATION and QUESTIONABLE registers; Fill ENABLE parts of all other registers with "1".	-	yes	-	-	yes	-
Fill PTRansition parts with "1"; Clear NTRansition parts	-	yes	-	-	yes	-
Clear error queue	yes	yes	-	-	-	yes
Clear output buffer	yes	yes	yes	1)	1)	1)
Clear command processing and input buffer	yes	yes	yes	-	-	-

1) The first command in a command line that immediately follows a <PROGRAM MESSAGE TERMINATOR> clears the output buffer.

19.17.12 Remote Commands of the Status Reporting System

The following commands control the status-reporting system. *RST does not influence the status registers.

The OPERATION status register contains information about the calibration status of the instrument.

The QUESTIONABLE status register contains information about the status of the reference and local oscillator, possible overloads of the instrument and the status of limit checks and limit margins.

The commands are independent from the measurement application.

FORMat:SREGister.....	351
STATus:PRESet.....	351
STATus:QUEue[:NEXT]?	352
STATus:OPERation[:EVENT]?	352
STATus:OPERation:ENABLE.....	352
STATus:OPERation:NTRansition.....	352
STATus:OPERation:PTRansition.....	353

STATus:QUESTionable:FREQuency[:EVENT]?	353
STATus:QUESTionable:LIMit[:EVENT]?	353
STATus:QUESTionable:POWer[:EVENT]?	353
STATus:QUESTionable[:EVENT]?	353
STATus:QUESTionable:FREQuency:CONDition?	353
STATus:QUESTionable:LIMit:CONDition?	353
STATus:QUESTionable:POWer:CONDition?	353
STATus:QUESTionable:CONDition?	353
STATus:QUESTionable:FREQuency:ENABle	353
STATus:QUESTionable:LIMit:ENABle	353
STATus:QUESTionable:POWer:ENABle	353
STATus:QUESTionable:ENABle	353
STATus:QUESTionable:FREQuency:NTRansition	354
STATus:QUESTionable:LIMit:NTRansition	354
STATus:QUESTionable:POWer:NTRansition	354
STATus:QUESTionable:NTRansition	354
STATus:QUESTionable:FREQuency:PTRansition	354
STATus:QUESTionable:LIMit:PTRansition	354
STATus:QUESTionable:POWer:PTRansition	354
STATus:QUESTionable:PTRansition	354

FORMat:SREGister <Format>

This command selects the data format for all queries of the status register.

Parameters:

<Format>	ASCIi Returns the data as ASCII bytes in <NR1> format.
	BINary Returns the data in binary format, preceded by '#B'.
	HEXadecimal Returns the data in hexadecimal format, preceded by '#H'.
	OCTal Returns the data in octal format, preceded by '#Q'.
*RST:	ASCIi

Example: //Select data format for status register queries
FORM:SREG BIN

STATus:PRESet

This command resets the edge detectors and ENABLE parts of all registers to a defined value. All PTRansition parts are set to FFFFh, i.e. all transitions from 0 to 1 are detected. All NTRansition parts are set to 0, i.e. a transition from 1 to 0 in a CONDition bit is not detected. The ENABle part of the STATus:OPERation and STATus:QUESTionable registers are set to 0, i.e. all events in these registers are not passed on.

Example: //Reset edge detectors and ENABLE parts of all registers
STAT:PRES

Usage: Event

STATus:QUEue[:NEXT]?

This command returns the earliest entry of the error queue and deletes it.

Positive error numbers indicate device-specific errors, negative error numbers are error messages defined by SCPI. If the error queue is empty, the error number 0, "No error", is returned.

This command is identical to the command `SYSTem:ERRor[:NEXT]?`.

Return values:

<Error>

Example: //Query error queue
 STAT:QUE?

Usage: Query only

STATus:OPERation[:EVENT]?

This command reads out the EVENT section of the OPERATION register.

The command at the same time deletes the contents of the EVENT section.

Return values:

<Event>

Usage: Query only

STATus:OPERation:ENABLE <SumBit>

This command controls the ENABLE part of the OPERATION register.

The ENABLE part allows true conditions in the EVENT part of the status register to be reported in the summary bit. If a bit is 1 in the enable register and its associated event bit transitions to true, a positive transition will occur in the summary bit reported to the next higher level.

Parameters:

<SumBit> <numeric value> (integer)
 Range: 0 to 65535

STATus:OPERation:NTRansition <SumBit>

This command controls the Negative TRansition part of the OPERATION register.

Setting a bit causes a 1 to 0 transition in the corresponding bit of the associated register. The transition also writes a 1 into the associated bit of the corresponding EVENT register.

Parameters:

<SumBit> <numeric value> (integer)
 Range: 0 to 65535

STATus:OPERation:PTRansition <SumBit>

This command controls the Positive TRansition part of the OPERation register.

Setting a bit causes a 0 to 1 transition in the corresponding bit of the associated register. The transition also writes a 1 into the associated bit of the corresponding EVENT register.

Parameters:

<SumBit> <numeric value> (integer)
 Range: 0 to 65535

STATus:QUESTionable:FREQuency[:EVENT]?
STATus:QUESTionable:LIMit[:EVENT]?
STATus:QUESTionable:POWEr[:EVENT]?
STATus:QUESTionable[:EVENT]?

This command reads out the EVENT section of the QUESTionable register.

The command at the same time deletes the contents of the EVENT section.

Return values:

<Condition>

Usage: Query only

STATus:QUESTionable:FREQuency:CONDition?
STATus:QUESTionable:LIMit:CONDition?
STATus:QUESTionable:POWEr:CONDition?
STATus:QUESTionable:CONDition?

This command reads out the CONDition section of the QUESTionable register.

The command does not delete the contents of the EVENT section.

Return values:

<Condition>

Usage: Query only

STATus:QUESTionable:FREQuency:ENABLE <SumBit>
STATus:QUESTionable:LIMit:ENABLE <SumBit>
STATus:QUESTionable:POWEr:ENABLE <SumBit>
STATus:QUESTionable:ENABLE <SumBit>

This command controls the ENABLE part of the QUESTionable register.

The ENABLE part allows true conditions in the EVENT part of the status register to be reported in the summary bit. If a bit is 1 in the enable register and its associated event bit transitions to true, a positive transition will occur in the summary bit reported to the next higher level.

Parameters:

<SumBit> <numeric value> (integer)
Range: 0 to 65535

STATus:QUESTIONable:FREQuency:NTRansition <SumBit>

STATus:QUESTIONable:LIMit:NTRansition <SumBit>

STATus:QUESTIONable:POWer:NTRansition <SumBit>

STATus:QUESTIONable:NTRansition <SumBit>

This command controls the Negative TRansition part of the QUESTIONable register.

Setting a bit causes a 1 to 0 transition in the corresponding bit of the associated register. The transition also writes a 1 into the associated bit of the corresponding EVENT register.

Parameters:

<SumBit> <numeric value> (integer)
Range: 0 to 65535

STATus:QUESTIONable:FREQuency:PTRansition <SumBit>

STATus:QUESTIONable:LIMit:PTRansition <SumBit>

STATus:QUESTIONable:POWer:PTRansition <SumBit>

STATus:QUESTIONable:PTRansition <SumBit>

This command control the Positive TRansition part of the QUESTIONable register.

Setting a bit causes a 0 to 1 transition in the corresponding bit of the associated register. The transition also writes a 1 into the associated bit of the corresponding EVENT register.

Parameters:

<SumBit> <numeric value> (integer)
Range: 0 to 65535

20 Function Reference

Find a list of all menus below.

• Function Reference: Setup	355
• Function Reference: Data Management	358
• Function Reference: Mode Selection	359
• Function Reference: Spectrum Application	360
• Function Reference: Receiver Application	377
• Function Reference: Analog Demodulation	387
• Function Reference: Digital Demodulation	391
• Function Reference: Vector Network Analyzer	395

20.1 Function Reference: Setup

Access: [Setup]

• Preset	355
• Instrument Setup	355
• User Preference	357

20.1.1 Preset

Access: [Preset]

Preset	355
------------------------------	-----

Preset

See "[Presetting the system](#)" on page 37.

Remote command:

`SYSTem:PRESet` on page 206

20.1.2 Instrument Setup

Access: [Setup] > "Instrument Setup"

Hardware	356
LAN	356
WiFi	356
Date and Time	356
Regional	356
Display	356
Audio	356
Power	356
Default Calibration	357
Reset	357

Hardware

See ["Selecting the BNC connector usage"](#) on page 39.

Remote command:

BNC connector: `SYSTem:BNC:MODE` on page 210

LAN

See ["Connecting the R&S FPC to a LAN"](#) on page 40.

Remote command:

MAC address: `SYSTem:COMMunicate:LAN:ETHernet?` on page 207

Gateway: `SYSTem:COMMunicate:LAN:GATeway` on page 207

Subnet mask: `SYSTem:COMMunicate:LAN:SUBMask` on page 208

IP address: `SYSTem:COMMunicate:SOCKet:ADDRess` on page 208

DHCP: `SYSTem:COMMunicate:SOCKet:DHCP[:STATE]` on page 208

WiFi

See ["Connecting the R&S FPC to a WLAN"](#) on page 41.

Remote command:

not supported

Date and Time

See [Chapter 9.3, "Date and Time"](#), on page 41.

Remote command:

Date: `SYSTem:DATE` on page 210

Time: `SYSTem:TIME` on page 214

Time zone: `SYSTem:TZONee` on page 214

Regional

See [Chapter 9.4, "Regional Settings"](#), on page 42.

Remote command:

Language: `SYSTem:LANGUage` on page 213

Language list: `SYSTem:LANGUage:CATalog?` on page 213

Date format: `DISPlay:DATE:FORMat` on page 210

Display

See [Chapter 9.5, "Display Settings"](#), on page 43.

Remote command:

`DISPlay:BRIGHtness` on page 215

Audio

See [Chapter 9.6, "Audio Settings"](#), on page 43.

Remote command:

Key click: `SYSTem:BEEPer:KEY:VOLume` on page 216

System beeper: `SYSTem:BEEPer:VOLume` on page 216

Beep on power overload: `SYSTem:BEEPer:POVerload[:STATE]` on page 216

Power

See [Chapter 9.7, "Power Settings"](#), on page 44.

not supported

Default Calibration

See ["Performing a default calibration"](#) on page 56.

Remote command:
not supported

Reset

See ["Resetting the system"](#) on page 37.

Remote command:
[SYSTem:PRESet:FACTory](#) on page 206

20.1.3 User Preference

Access: [Setup] > "User Preferences"

Site	357
Preset Key	357
Working Directory	357
Capture	357
Dataset	358
Spectrum	358
Documentation	358

Site

See ["Defining meta information for datasets"](#) on page 49.

Remote command:
not supported

Preset Key

See [Chapter 8, "Preset"](#), on page 37.

Remote command:
Preset mode: [SYSTem:PRESet:MODE](#) on page 206
Preset dataset: [SYSTem:PRESet:USER](#) on page 207
Discard calibration data: [SYSTem:PRESet:CALibration:DISCard](#) on page 231

Working Directory

See ["Changing the default directory to store data"](#) on page 49.

Remote command:
not supported

Capture

See ["Taking screenshots"](#) on page 51.

Remote command:
File name: [MMEMory:NAME](#) on page 224
File format: [HCOPY:DEVice:LANGUage](#) on page 217

Dataset

See ["Changing the default file name for datasets"](#) on page 50.

Remote command:
not supported

Spectrum

See ["Selecting the sweep type"](#) on page 111.

Remote command:
not supported

Documentation

See [Chapter 1, "Documentation Overview"](#), on page 7.

Remote command:
not supported

20.2 Function Reference: Data Management

Access: "Save Recall"

Save	358
Recall	358
Recall Screenshot	358
Wizard	358
File Manager	359

Save

See ["Saving datasets"](#) on page 48.

Remote command:
[MMEMoRY:STORe:STATe](#) on page 224

Recall

See ["Restoring datasets"](#) on page 50.

Remote command:
[MMEMoRY:LOAD:STATe](#) on page 222

Recall Screenshot

See ["Previewing screenshots"](#) on page 51.

Remote command:
[MMEMoRY:LOAD:STATe](#) on page 222

Wizard

See [Chapter 13, "Measurement Wizard"](#), on page 59.

Remote command:
not supported

File Manager

See ["Using in the file manager"](#) on page 47.

Remote command:

Save dataset: [MMEMory:STORe:STATe](#) on page 224

Restore dataset: [MMEMory:LOAD:STATe](#) on page 222

Query files: [MMEMory:CATalog?](#) on page 218

Query folder structure: [MMEMory:CATalog:DIRectories?](#) on page 218

Change directory: [MMEMory:CDIRectory](#) on page 219

Copy file: [MMEMory:COpy](#) on page 219

Write content to file: [MMEMory:DATA](#) on page 219

Delete file: [MMEMory:DELeTe](#) on page 220

Create file: [MMEMory:FILE](#) on page 221

Create directory: [MMEMory:MDIRectory](#) on page 223

Move file: [MMEMory:MOVE](#) on page 223

Delete directory: [MMEMory:RDIRectory](#) on page 224

20.3 Function Reference: Mode Selection

Access: [Mode]

Spectrum	359
Analog Demod	359
Digital Demod	359
Receiver	359
Vector Network Analyzer	360

Spectrum

See ["Selecting the spectrum application"](#) on page 66.

Remote command:

[INSTrument\[:SELeCt\]](#) on page 231

Analog Demod

See ["Selecting the analog demodulation measurement application"](#) on page 147.

Remote command:

[INSTrument\[:SELeCt\]](#) on page 231

Digital Demod

See ["Selecting the digital demodulation measurement application"](#) on page 158.

Remote command:

[INSTrument\[:SELeCt\]](#) on page 231

Receiver

See ["Selecting the receiver application"](#) on page 134.

Remote command:

[INSTrument\[:SELeCt\]](#) on page 231

Vector Network Analyzer

See ["Selecting the VNA application"](#) on page 170.

Remote command:

[INSTrument \[:SElect\]](#) on page 231

20.4 Function Reference: Spectrum Application

Access: [Mode] > "Spectrum"

• Measurement Menu: Measurement Mode	360
• Measurement Menu: Channel Power	362
• Measurement Menu: TOI	362
• Measurement Menu: Spectrogram	363
• Measurement Menu: Spectrogram Playback	364
• Measurement Menu: TDMA Power	364
• Measurement Menu: Harmonic Distortion	365
• Measurement Menu: AM Modulation Depth	366
• Measurement Menu: Occupied Bandwidth	366
• Measurement Menu: Signal Source	367
• Frequency Menu	368
• Span Menu	369
• Amplitude Menu	369
• Bandwidth Menu	371
• Sweep Menu	371
• Trace Menu	372
• Lines Menu	373
• Marker Menu	374
• Marker To Menu	376

20.4.1 Measurement Menu: Measurement Mode

Access: [Meas] > "Measurement Mode"

Spectrum	360
Channel Power	361
Third Order Intermod	361
Spectrogram	361
Spectrogram Playback	361
TDMA Power	361
Harmonic Distortion	361
AM Modulation Depth	361
Occupied Bandwidth	361

Spectrum

See ["Measuring basic spectrum characteristics"](#) on page 68.

Remote command:

[CALCulate<n>:MARKer<m>:FUNCTION:POWER\[:STATE\]](#) on page 236

Channel Power

See ["Selecting the channel power measurement"](#) on page 70.

Remote command:

Selection: `CALCulate<n>:MARKer<m>:FUNCTION:POWER:SElect` on page 235

State: `CALCulate<n>:MARKer<m>:FUNCTION:POWER[:STATe]` on page 236

Result: `CALCulate<n>:MARKer<m>:FUNCTION:POWER:RESult?` on page 234

Third Order Intermod.

See ["Selecting the TOI measurement"](#) on page 75.

Remote command:

`CALCulate<n>:MARKer<n>:FUNCTION:TOI[:STATe]` on page 239

Spectrogram

See [Chapter 14.2.7, "Working with the Spectrogram Result Display"](#), on page 84.

Remote command:

not supported

Spectrogram Playback

See [Chapter 14.2.7, "Working with the Spectrogram Result Display"](#), on page 84.

Remote command:

not supported

TDMA Power

See ["Selecting the TDMA power measurement"](#) on page 76.

Remote command:

Selection: `CALCulate<n>:MARKer<m>:FUNCTION:POWER:SElect` on page 235

State: `CALCulate<n>:MARKer<m>:FUNCTION:POWER[:STATe]` on page 236

Result: `CALCulate<n>:MARKer<m>:FUNCTION:POWER:RESult?` on page 234

Harmonic Distortion

See ["Selecting the harmonic distortion measurement"](#) on page 78.

Remote command:

`CALCulate<n>:MARKer<m>:FUNCTION:HARMonics[:STATe]` on page 244

AM Modulation Depth

See ["Selecting the AM modulation depth measurement"](#) on page 80.

Remote command:

`CALCulate<n>:MARKer<m>:FUNCTION:MDEPth[:STATe]` on page 245

Occupied Bandwidth

See ["Selecting the OBW measurement"](#) on page 81.

Remote command:

Selection: `CALCulate<n>:MARKer<m>:FUNCTION:POWER:SElect` on page 235

State: `CALCulate<n>:MARKer<m>:FUNCTION:POWER[:STATe]` on page 236

Result: `CALCulate<n>:MARKer<m>:FUNCTION:POWER:RESult?` on page 234

20.4.2 Measurement Menu: Channel Power

Access: [Meas] > "Measurement Mode" > "Channel Power"

Standard.....	362
Level Adjust.....	362
Channel Bandwidth.....	362
Power Unit.....	362
Power Display.....	362

Standard

See "Selecting a standard" on page 72.

Remote command:

`CALCulate<n>:MARKer<m>:FUNCTION:POWER:PRESet` on page 233

Level Adjust

See "Defining the reference level" on page 73.

Remote command:

`CALCulate<n>:MARKer<m>:FUNCTION:LEVEL:ONCE` on page 233

Channel Bandwidth

See "Defining the channel bandwidth" on page 71.

Remote command:

`CALCulate<n>:MARKer<m>:FUNCTION:CPOWER:BANDwidth` on page 237

Power Unit

See "Selecting the unit for power display" on page 72.

Remote command:

`CALCulate<n>:MARKer<m>:FUNCTION:CPOWER:UNIT` on page 238

Power Display

See "Measuring the maximum channel power" on page 71 and "Measuring the channel power density" on page 72.

Remote command:

Maximum: `CALCulate<n>:MARKer<m>:FUNCTION:CPOWER:MODE` on page 237

Density: `CALCulate<n>:MARKer<m>:FUNCTION:POWER:RESult:PHZ` on page 238

20.4.3 Measurement Menu: TOI

Access: [Meas] > "Measurement Mode" > "Third Order Intermod."

Search Signals.....	362
Marker <x>.....	363

Search Signals

See "Searching for signals" on page 75.

Remote command:

`CALCulate<n>:MARKer<m>:FUNCTION:TOI:SEARChsignal` on page 239

Marker <x>

See ["Selecting the TOI measurement"](#) on page 75.

For manual marker control, see [Chapter 14.9.1, "Marker Positioning"](#), on page 120.

Remote command:

[CALCulate<n>:MARKer<m>:FUNction:TOI:RESult?](#) on page 238

20.4.4 Measurement Menu: Spectrogram

Access: [Meas] > "Measurement Mode" > "Spectrogram"

Settings	363
Playback	363
Full Screen	363
Save	363
Clear	363
Hold	363

Settings

See [Chapter 14.2.7.2, "Color Definition"](#), on page 87.

Remote command:

not supported

Playback

See [Chapter 14.2.7.3, "Spectrogram Playback"](#), on page 90.

Remote command:

not supported

Full Screen

See ["Displaying the spectrogram in full screen"](#) on page 86.

Remote command:

not supported

Save

See ["Saving spectrogram data"](#) on page 90.

Remote command:

not supported

Clear

See ["Resetting the spectrogram"](#) on page 86.

Remote command:

not supported

Hold

See ["Controlling the spectrogram update"](#) on page 85.

Remote command:

not supported

20.4.5 Measurement Menu: Spectrogram Playback

Access: [Meas] > "Measurement Mode" > "Spectrogram Playback"

Settings.....	364
Live Update.....	364
Full Screen.....	364
Save.....	364
Recall.....	364
Time Line <x>.....	364

Settings

See [Chapter 14.2.7.2, "Color Definition"](#), on page 87.

Remote command:
not supported

Live Update

See ["Switching back to active spectrogram recording"](#) on page 93.

Remote command:
not supported

Full Screen

See ["Displaying the spectrogram in full screen"](#) on page 86.

Remote command:
not supported

Save

See ["Saving spectrogram data"](#) on page 90.

Remote command:
not supported

Recall

See ["Restoring a spectrogram"](#) on page 91.

Remote command:
not supported

Time Line <x>

See ["Working with time lines in playback mode"](#) on page 91.

Remote command:
not supported

20.4.6 Measurement Menu: TDMA Power

Access: [Meas] > "Measurement Mode" > "TDMA Power"

Standard.....	365
Level Adjust.....	365
Sweep Time.....	365
Burst Length.....	365

Standard

See "Selecting a standard" on page 76.

Remote command:

`CALCulate<n>:MARKer<m>:FUNCTION:POWer:PRESet` on page 233

Level Adjust

See "Defining the reference level" on page 77.

Remote command:

`CALCulate<n>:MARKer<m>:FUNCTION:LEVel:ONCE` on page 233

Sweep Time

See "Defining the sweep time" on page 110.

Remote command:

`[SENSe:]SWEep:TIME` on page 261

Burst Length

See "Defining the burst length" on page 77.

Remote command:

`CALCulate<n>:MARKer<m>:FUNCTION:TDMA:BURSt` on page 241

20.4.7 Measurement Menu: Harmonic Distortion

Access: [Meas] > "Measurement Mode" > "Harmonic Distortion"

Adjust Setting.....	365
Harmonics.....	365

Adjust Setting

See "Optimizing measurement settings" on page 79.

Remote command:

`CALCulate<n>:MARKer<m>:FUNCTION:HARMonics:PRESet` on page 243

Harmonics

See "Defining the number of harmonics" on page 79.

Remote command:

Harmonics: `CALCulate<n>:MARKer<m>:FUNCTION:HARMonics:NHARmonics`
on page 243

Distortion: `CALCulate<n>:MARKer<m>:FUNCTION:HARMonics:DISToTion?`
on page 242

Position of harmonics: `CALCulate<n>:MARKer<m>:FUNCTION:HARMonics:LIST?`
on page 242

20.4.8 Measurement Menu: AM Modulation Depth

Access: [Meas] > "Measurement Mode" > "AM Modulation Depth"

Adjust Setting.....	366
Threshold.....	366
Marker <x>.....	366

Adjust Setting

See "Optimizing the measurement settings" on page 80.

Remote command:
not supported

Threshold

See "Defining a threshold" on page 80.

Remote command:
not supported

Marker <x>

See "Moving the markers" on page 80.

For manual marker control, also see [Chapter 14.9.1, "Marker Positioning"](#), on page 120.

Remote command:

`CALCulate<n>:MARKer<m>:FUNCTION:MDEPth:RESult?` on page 244

20.4.9 Measurement Menu: Occupied Bandwidth

Access: [Meas] > "Measurement Mode" > "Occupied Bandwidth"

Standard.....	366
Level Adjust.....	366
Channel Bandwidth.....	366
% Power Bandwidth.....	367

Standard

See "Selecting a standard" on page 83.

Remote command:

`CALCulate<n>:MARKer<m>:FUNCTION:POWer:PRESet` on page 233

Level Adjust

See "Defining the reference level" on page 83.

Remote command:

`CALCulate<n>:MARKer<m>:FUNCTION:LEVel:ONCE` on page 233

Channel Bandwidth

See "Defining the channel bandwidth" on page 82.

Remote command:

`CALCulate<n>:MARKer<m>:FUNCTION:OBAN:BANDwidth` on page 240

% Power Bandwidth

See "Defining the percentage of the occupied bandwidth" on page 82.

Remote command:

`CALCulate<n>:MARKer<m>:FUNCTION:OBAN:BANDwidth:PCT` on page 240

20.4.10 Measurement Menu: Signal Source

Access: [Meas] > "Source"

Off.....	367
CW.....	367
Coupled CW.....	367
Tracking Generator.....	367
Level.....	367
Normalize S21.....	367
Normalization S21.....	368

Off

See "Selecting the output frequency" on page 52.

Remote command:

`SOURCE:TG[:STATe]` on page 228

CW

See "Selecting the output frequency" on page 52.

Remote command:

`SOURCE:TG:FREQuency` on page 226

Coupled CW

See "Selecting the output frequency" on page 52.

Remote command:

`SOURCE:TG:FREQuency:AUTO` on page 227

Tracking Generator

See "Selecting the output frequency" on page 52.

Remote command:

`SOURCE:TG:AUTO` on page 226

Level

See "Defining the output level" on page 53.

Remote command:

`SOURCE:TG:POWer` on page 227

Normalize S21

See "Calibrating a measurement" on page 56.

Remote command:
[CALibration<n>:START?](#) on page 230

Normalization S21

See "[Activating correction](#)" on page 57.

Remote command:
 not supported

20.4.11 Frequency Menu

Access: [Freq]

Center Frequency	368
Center Freq Step Size	368
Start Frequency	368
Stop Frequency	368
Frequency Offset	368
Frequency Mode	368

Center Frequency

See "[Defining a center frequency](#)" on page 94.

Remote command:
[\[SENSe:\] FREQuency:CENTer](#) on page 248

Center Freq Step Size

See "[Defining a frequency step size](#)" on page 94.

Remote command:
 Mode: [\[SENSe:\] FREQuency:CENTer:STEP:LINK](#) on page 248
 Manual step size: [\[SENSe:\] FREQuency:CENTer:STEP](#) on page 248

Start Frequency

See "[Defining a start and stop frequency](#)" on page 97.

Remote command:
[\[SENSe:\] FREQuency:START](#) on page 251

Stop Frequency

See "[Defining a start and stop frequency](#)" on page 97.

Remote command:
[\[SENSe:\] FREQuency:STOP](#) on page 251

Frequency Offset

See "[Defining a frequency offset](#)" on page 95.

Remote command:
[\[SENSe:\] FREQuency:OFFSet](#) on page 250

Frequency Mode

See "[Working with channel tables](#)" on page 97.

Remote command:

Mode: [SENSe:] FREQuency:MODE on page 249

Input mode: [SENSe:] FREQuency: INPut:MODE on page 249

Channel table (DL): [SENSe:] CHANnel: TABLE: SElect: DOWNlink on page 246

Channel table (UL): [SENSe:] CHANnel: TABLE: SElect: UPLink on page 246

Channel selection: [SENSe:] CHANnel on page 246

20.4.12 Span Menu

Access: [Span]

Manual Span.....	369
Full Span.....	369
Zero Span.....	369
Last Span.....	369

Manual Span

See "Defining the frequency span" on page 96.

Remote command:

State: [SENSe:] FREQuency: SPAN: AUTO on page 336

Span: [SENSe:] FREQuency: SPAN on page 250

Full Span

See "Defining the frequency span" on page 96.

Remote command:

[SENSe:] FREQuency: SPAN: FULL on page 251

Zero Span

See "Defining the frequency span" on page 96.

Remote command:

[SENSe:] FREQuency: SPAN on page 250

Last Span

See "Defining the frequency span" on page 96.

Remote command:

not supported

20.4.13 Amplitude Menu

Access: [Ampt]

Reference Level.....	370
Range / Ref Position.....	370
Auto Range.....	370
Unit.....	370
Preamplifier.....	370

Attenuator.....	370
Impedance.....	370
Transducer.....	371

Reference Level

See "Defining a reference level" on page 99.

Remote command:

`DISPlay<n>[:WINDow]:TRACe<t>:Y[:SCALe]:RLEVel` on page 253

Range / Ref Position

See "Defining a display range" on page 104, "Defining the position of the reference level" on page 100 and "Defining a reference offset" on page 100.

Remote command:

Scale (y-axis): `DISPlay<n>[:WINDow]:TRACe<t>:Y:SPACing` on page 252

Range (y-axis): `DISPlay<n>[:WINDow]:TRACe<t>:Y[:SCALe]` on page 252

Range (automatic): `DISPlay<n>[:WINDow]:TRACe<t>:Y[:SCALe]:ADJust` on page 253

Reference position: `DISPlay<n>[:WINDow]:TRACe<t>:Y[:SCALe]:RPOSition` on page 254

Reference offset: `DISPlay<n>[:WINDow]:TRACe<t>:Y[:SCALe]:RLEVel:OFFSet` on page 254

Auto Range

See "Defining a display range" on page 104.

Remote command:

`DISPlay<n>[:WINDow]:TRACe<t>:Y[:SCALe]:ADJust` on page 253

Unit

See "Selecting the display unit" on page 103.

Remote command:

`UNIT<n>:POWer` on page 258

Preamplifier

See "Turning the preamplifier on and off" on page 103.

Remote command:

`INPut:GAIN:STATe` on page 256

Attenuator

See "Defining RF attenuation" on page 101.

Remote command:

Attenuation: `INPut:ATTenuation` on page 255

Automatic attenuation: `INPut:ATTenuation:AUTO` on page 255

Attenuation mode: `INPut:ATTenuation:MODE` on page 256

Impedance

See "Selecting the input impedance" on page 98.

Remote command:

Impedance: `INPut:IMPedance` on page 256

Matching pad: `INPut:IMPedance:PAD` on page 257

Transducer

See "Selecting transducer factors" on page 105.

Remote command:

Selection: `[SENSe:]CORRection:TRANsducer<td>:SELEct` on page 257

State: `[SENSe:]CORRection:TRANsducer<td>[:STATe]` on page 258

Query unit: `[SENSe:]CORRection:TRANsducer<td>:UNIT?` on page 258

20.4.14 Bandwidth Menu

Access: [BW]

<code>RBW: Manual</code>	371
<code>RBW: Auto</code>	371
<code>VBW: Manual</code>	371
<code>VBW: Auto</code>	371

RBW: Manual

See "Setting the resolution bandwidth" on page 107.

Remote command:

`[SENSe:]BANDwidth[:RESolution]` on page 259

RBW: Auto

See "Setting the resolution bandwidth" on page 107.

Remote command:

`[SENSe:]BANDwidth[:RESolution]:AUTO` on page 260

VBW: Manual

See "Setting the video bandwidth" on page 109.

Remote command:

`[SENSe:]BANDwidth:VIDeo` on page 260

VBW: Auto

See "Setting the video bandwidth" on page 109.

Remote command:

`[SENSe:]BANDwidth:VIDeo:AUTO` on page 260

20.4.15 Sweep Menu

Access: [Sweep]

Continuous Sweep.....	372
Single Sweep.....	372
Sweep Time: Auto.....	372
Sweep Time: Manual.....	372
Trigger.....	372

Continuous Sweep

See "Selecting the sweep mode" on page 111.

Remote command:

Sweep mode: `INITiate:CONTinuous` on page 262

Start sweep: `INITiate[:IMMediate]` on page 263

Single Sweep

See "Selecting the sweep mode" on page 111.

Remote command:

Sweep mode: `INITiate:CONTinuous` on page 262

Start sweep: `INITiate[:IMMediate]` on page 263

Sweep Time: Auto

See "Defining the sweep time" on page 110.

Remote command:

`[SENSe:]SWEep:TIME:AUTO` on page 262

Sweep Time: Manual

See "Defining the sweep time" on page 110.

Remote command:

`[SENSe:]SWEep:TIME` on page 261

Trigger

See "Selecting the trigger source" on page 112 and "Defining a trigger delay" on page 113.

Remote command:

Trigger source: `TRIGger[:SEquence]:SOURce` on page 265

Trigger level (video): `TRIGger[:SEquence]:LEVel:VIDeo` on page 264

Trigger slope (external): `TRIGger[:SEquence]:SLOPe` on page 264

Delay (external): `TRIGger[:SEquence]:HOLDoff[:TIME]` on page 264

20.4.16 Trace Menu

Access: [Trace]

Select Trace.....	373
Trace Mode.....	373
Detector.....	373
Memory Traces.....	373
Trace Math.....	373

Select Trace

See ["Selecting a trace"](#) on page 114 and ["Selecting a second trace"](#) on page 114.

Remote command:

`DISPlay<n>[:WINDow]:TRACe<t>[:STATe]` on page 268

Trace Mode

See ["Selecting the trace mode"](#) on page 116.

Remote command:

Trace mode: `DISPlay<n>[:WINDow]:TRACe<t>:MODE` on page 267

of averages: `[SENSe:]SWEep:COUNT` on page 270

Detector

See ["Selecting the detector"](#) on page 117.

Remote command:

Detector: `[SENSe:]DETEctor<t>[:FUNction]` on page 269

Auto detector: `[SENSe:]DETEctor<t>[:FUNction]:AUTO` on page 270

Memory Traces

See ["Working with memory traces"](#) on page 117.

Remote command:

Copy trace: `CALCulate<n>:MATH<t>:COPY:MEMory` on page 266

Memory trace state: `DISPlay<n>[:WINDow]:TRACe<t>:MEMory[:STATe]`
on page 267

Trace Math

See ["Using trace mathematics"](#) on page 118.

Remote command:

State: `CALCulate<n>:MATH<t>:STATe` on page 267

Operation: `CALCulate<n>:MATH<t>[:EXPRession][:DEFine]` on page 266

20.4.17 Lines Menu

Access: [Lines]

Display Line	373
Show Limit Lines	374
Upper Limit	374
Lower Limit	374
Audio Beep	374

Display Line

See ["Using a display line"](#) on page 129.

Remote command:

State: `CALCulate<n>:DLINe:STATe` on page 288

Position: `CALCulate<n>:DLINe` on page 288

Show Limit Lines

See "Hiding a limit line" on page 132.

Remote command:

`CALCulate<n>:LIMit<k>:STATe` on page 293

Upper Limit

See "Selecting a limit line" on page 131, "Using a threshold line" on page 131 and "Removing limit lines" on page 132.

Remote command:

Threshold line: `CALCulate<n>:LIMit<k>:UPPer:THReshold` on page 295

Custom line: `CALCulate<n>:LIMit<k>:UPPer:SElect` on page 294

Removal: `CALCulate<n>:LIMit<k>:DElete` on page 291

Limit check: `CALCulate<n>:LIMit<k>:FAIL?` on page 291

Lower Limit

See "Selecting a limit line" on page 131, "Using a threshold line" on page 131 and "Removing limit lines" on page 132.

Remote command:

Threshold line: `CALCulate<n>:LIMit<k>:LOWer:THReshold` on page 292

Custom line: `CALCulate<n>:LIMit<k>:LOWer:SElect` on page 292

Removal: `CALCulate<n>:LIMit<k>:DElete` on page 291

Limit check: `CALCulate<n>:LIMit<k>:FAIL?` on page 291

Audio Beep

See "Performing limit checks" on page 132.

Remote command:

`CALCulate<n>:LIMit<k>:BEEP[:STATe]` on page 289

20.4.18 Marker Menu

Access: [Mkr]

<code>Marker <x></code>	374
<code>Marker Type</code>	375
<code>Marker Mode</code>	375
<code>Marker Demodulation</code>	375
<code>All Markers On</code>	375
<code>Marker Display</code>	375
<code>All Markers Off</code>	376

Marker <x>

See "Positioning a marker" on page 121 and "Adding additional markers" on page 121.

Remote command:

Marker state: `CALCulate<n>:MARKer<m>[:STATe]` on page 278

Marker position (x-axis): `CALCulate<n>:MARKer<m>:X` on page 279

Marker position (y-axis): `CALCulate<n>:MARKer<m>:Y?` on page 281

Delta marker state: `CALCulate<n>:DELTaMarker<m>[:STATe]` on page 273

Delta marker position (x-axis): `CALCulate<n>:DELTaMarker<m>:X` on page 273

Delta marker position (relative): `CALCulate<n>:DELTaMarker<m>:X:RELative` on page 274

Delta marker position (y-axis): `CALCulate<n>:DELTaMarker<m>:Y?` on page 275

Marker Type

See ["Selecting the marker type"](#) on page 122.

Remote command:

With corresponding syntax `MARKer` or `DELTaMarker`

Marker Mode

See [Chapter 14.10, "Marker Functions"](#), on page 125.

Remote command:

Noise: `CALCulate<n>:MARKer<m>:FUNction:NOISE[:STATe]` on page 287

Noise result: `CALCulate<n>:MARKer<m>:FUNction:NOISE:RESult?` on page 286

Frequency count: `CALCulate<n>:MARKer<m>:COUNT[:STATe]` on page 282

Frequency count: `CALCulate<n>:MARKer<m>:COUNT:FREQuency?` on page 282

n dB down: `CALCulate<n>:MARKer<m>:FUNction:NDBDown:STATe` on page 286

n dB: `CALCulate<n>:MARKer<m>:FUNction:NDBDown` on page 284

n dB down frequency: `CALCulate<n>:MARKer<m>:FUNction:NDBDown:FREQuency?` on page 285

n dB down result: `CALCulate<n>:MARKer<m>:FUNction:NDBDown:RESult?` on page 285

Marker Demodulation

See [Chapter 14.10.4, "Marker Demodulation"](#), on page 128.

Remote command:

State: `CALCulate<n>:MARKer<m>:FUNction:DEModulation[:STATe]` on page 284

Modulation: `CALCulate<n>:MARKer<m>:FUNction:DEModulation:SELect` on page 283

Demodulation time: `CALCulate<n>:MARKer<m>:FUNction:DEModulation:HOLD` on page 283

Volume: `SYSTem:AUDio:VOLume` on page 287

All Markers On

See ["Adding additional markers"](#) on page 121.

Remote command:

not supported

Marker Display

See ["Selecting the marker display type"](#) on page 122.

Remote command:

`CALCulate<n>:MARKer<m>:FREQuency:MODE` on page 276

All Markers Off

See ["Removing markers or delta markers"](#) on page 122.

Remote command:

Markers: `CALCulate<n>:MARKer<m>:AOFF` on page 275

Delta markers: `CALCulate<n>:DELTamarker<m>:AOFF` on page 271

20.4.19 Marker To Menu

Access: [Mkr →]

Set To Peak	376
Set To Next Peak	376
Set To Minimum	376
All Markers To Peak	376
Center = Marker / Level = Marker	376
Marker Tracking	377
Select Marker	377
Search Range	377

Set To Peak

See ["Positioning markers automatically"](#) on page 123.

Remote command:

Marker: `CALCulate<n>:MARKer<m>:MAXimum[:PEAK]` on page 277

Delta marker: `CALCulate<n>:DELTamarker<m>:MAXimum[:PEAK]` on page 272

Set To Next Peak

See ["Positioning markers automatically"](#) on page 123.

Remote command:

Marker: `CALCulate<n>:MARKer<m>:MAXimum:NEXT` on page 277

Delta marker: `CALCulate<n>:DELTamarker<m>:MAXimum:NEXT` on page 272

Set To Minimum

See ["Positioning markers automatically"](#) on page 123.

Remote command:

Marker: `CALCulate<n>:MARKer<m>:MINimum[:PEAK]` on page 278

Delta marker: `CALCulate<n>:DELTamarker<m>:MINimum[:PEAK]` on page 273

All Markers To Peak

See ["Positioning markers automatically"](#) on page 123.

Remote command:

not supported

Center = Marker / Level = Marker

See ["Positioning markers automatically"](#) on page 123.

Remote command:

Center = marker frequency: `CALCulate<n>:MARKer<m>:FUNCTION:CENTer`
on page 276

Ref level = marker level: `CALCulate<n>:MARKer<m>:FUNCTION:REFerence`
on page 276

Marker Tracking

See "Keeping the marker on the peak" on page 124.

Remote command:

`CALCulate<n>:MARKer<m>:FUNCTION:STRack[:STATe]` on page 277

Select Marker

See "Selecting a marker" on page 123.

Remote command:

With suffix at `MARKer` or `DELTaMarker`

Search Range

See "Defining marker search range" on page 124.

Remote command:

Search range: `CALCulate<n>:MARKer<m>:X:SLIMits<slim>[:STATe]`
on page 280

Left limit: `CALCulate<n>:MARKer<m>:X:SLIMits<slim>:LEFT` on page 279

Right limit: `CALCulate<n>:MARKer<m>:X:SLIMits<slim>:RIGHT` on page 280

20.5 Function Reference: Receiver Application

Access: [Mode] > "Receiver"

• Measurement Menu	377
• Frequency Menu	378
• Amplitude Menu	380
• Bandwidth Menu	381
• Sweep Menu	382
• Trace Menu	382
• Lines Menu	383
• Marker Menu	384
• Marker To Menu	386

20.5.1 Measurement Menu

Access: [Meas]

Bargraph	378
Frequency Scan	378
Show Bargraph 2	378
Show Trace 2	378

Detector.....	378
Refresh Max Hold.....	378
View Peak List.....	378

Bargraph

See "Selecting bargraph measurements" on page 135.

Remote command:

[SENSe:] FREQuency:MODE on page 296

Frequency Scan

See "Selecting frequency scans" on page 136.

Remote command:

[SENSe:] FREQuency:MODE on page 296

Show Bargraph 2

See "Displaying a second bargraph" on page 135.

(Only for bargraph measurements.)

Remote command:

DISPlay<n>[:WINDow]:TRACe<t>[:STATe] on page 268

Show Trace 2

See "Displaying a second trace" on page 137.

(Only for frequency scans.)

Remote command:

DISPlay<n>[:WINDow]:TRACe<t>[:STATe] on page 268

Detector

See Chapter 15.6, "Trace Configuration", on page 144.

Remote command:

[SENSe:] DETector<t>[:FUNction] on page 300

Refresh Max Hold

See "Resetting the max hold " on page 138.

Remote command:

DISPlay:BARGraph:PHOLd:RESet on page 296

View Peak List

See "Displaying the peak list" on page 137.

(Only for frequency scans.)

Remote command:

not supported

20.5.2 Frequency Menu

Access: [Freq]

Frequency

See ["Defining the receiver frequency"](#) on page 139.

(Bargraph measurements only.)

Remote command:

[SENSe:] FREQuency: CENTer on page 297

Frequency Step

See ["Defining a frequency step size"](#) on page 139.

(Bargraph measurements only.)

Remote command:

[SENSe:] FREQuency: CENTer: STEP on page 248

Scan Step

See ["Defining a scan range"](#) on page 140.

(Frequency scans only.)

Remote command:

[SENSe:] SCAN: STEP on page 297

Start Frequency

See ["Defining a scan range"](#) on page 140.

Remote command:

[SENSe:] SCAN: START on page 297

Stop Frequency

See ["Defining a scan range"](#) on page 140.

Remote command:

[SENSe:] SCAN: STOP on page 298

Full Scan

See ["Defining a scan range"](#) on page 140.

Remote command:

not supported

Frequency Mode

See ["Using channel tables"](#) on page 139 and ["Performing a channel scan"](#) on page 140.

Remote command:

Mode: [SENSe:] FREQuency: INPut: MODE on page 249

Channel selection: [SENSe:] CHANnel on page 246

Linear Scale

See ["Selecting the scale of the x-axis"](#) on page 141.

Remote command:

[SENSe:] SWEEp: SPACing on page 298

Log Scale

See ["Selecting the scale of the x-axis"](#) on page 141.

Remote command:

[\[SENSe:\] SWEEp:SPACing](#) on page 298

20.5.3 Amplitude Menu

Access: [Ampt]

Reference Level	380
Range / Ref Position	380
Auto Range	380
Unit	381
Preamplifier	381
Attenuator	381
Impedance	381
Transducer	381

Reference Level

See ["Defining a reference level"](#) on page 99.

Remote command:

[DISPlay<n>\[:WINDow\]:TRACe<t>:Y\[:SCALe\]:RLEVel](#) on page 253

Range / Ref Position

Bargraph:

- ["Defining the bargraph scale"](#) on page 142

Frequency scan:

- ["Defining a display range"](#) on page 104
- ["Defining the position of the reference level"](#) on page 100
- ["Defining a reference offset"](#) on page 100

Remote command:

Scale (y-axis): [DISPlay<n>\[:WINDow\]:TRACe<t>:Y:SPACing](#) on page 252

Range (y-axis): [DISPlay<n>\[:WINDow\]:TRACe<t>:Y\[:SCALe\]](#) on page 252

Range (automatic): [DISPlay<n>\[:WINDow\]:TRACe<t>:Y\[:SCALe\]:ADJust](#) on page 253

Reference position: [DISPlay<n>\[:WINDow\]:TRACe<t>:Y\[:SCALe\]:RPOStion](#) on page 254

Reference offset: [DISPlay<n>\[:WINDow\]:TRACe<t>:Y\[:SCALe\]:RLEVel:OFFSet](#) on page 254

Auto Range

Bargraph: ["Defining the bargraph scale"](#) on page 142

Frequency scan: ["Defining a display range"](#) on page 104.

Remote command:

[DISPlay<n>\[:WINDow\]:TRACe<t>:Y\[:SCALe\]:ADJust](#) on page 253

Unit

See "Selecting the display unit" on page 103.

Remote command:

`UNIT<n>:POWer` on page 258

Preamplifier

See "Turning the preamplifier on and off" on page 103.

Remote command:

`INPut:GAIN:STATe` on page 256

Attenuator

See "Defining RF attenuation" on page 101.

Remote command:

Attenuation: `INPut:ATTenuation` on page 255

Automatic attenuation: `INPut:ATTenuation:AUTO` on page 255

Attenuation mode: `INPut:ATTenuation:MODE` on page 256

Impedance

See "Selecting the input impedance" on page 98.

Remote command:

Impedance: `INPut:IMPedance` on page 256

Matching pad: `INPut:IMPedance:PAD` on page 257

Transducer

See "Selecting transducer factors" on page 105.

Remote command:

Selection: `[SENSe:]CORRection:TRANsducer<td>:SElect` on page 257

State: `[SENSe:]CORRection:TRANsducer<td>[:STATe]` on page 258

20.5.4 Bandwidth Menu

Access: [BW]

`RBW: Manual`..... 381

`CISPR BW: Manual`..... 381

`CISPR BW: Auto`..... 382

RBW: Manual

See "Selecting the bandwidth" on page 143.

Remote command:

`[SENSe:]BANDwidth[:RESolution]` on page 259

CISPR BW: Manual

See "Selecting the bandwidth" on page 143.

Remote command:

`[SENSe:]BANDwidth[:RESolution]:CISPr` on page 299

CISPR BW: Auto

See "Selecting the bandwidth" on page 143.

Remote command:

[SENSe:]BANDwidth[:RESolution]:CISPr:AUTO on page 300

20.5.5 Sweep Menu

Access: [Sweep]

Measurement Time.....	382
Continuous Scan.....	382
Single Scan.....	382

Measurement Time

See "Defining the measurement time" on page 144.

Remote command:

[SENSe:]SWEep:TIME on page 261

Continuous Scan

See "Selecting the measurement mode" on page 144.

Remote command:

Scan mode: INITiate:CONTinuous on page 262

Start scan: INITiate[:IMMediate] on page 263

Single Scan

See "Selecting the measurement mode" on page 144.

Remote command:

Scan mode: INITiate:CONTinuous on page 262

Start scan: INITiate[:IMMediate] on page 263

20.5.6 Trace Menu

Access: [Trace]

Select Trace.....	382
Trace Mode.....	383
Detector.....	383
Memory.....	383
Trace ► Memory.....	383
Trace Style: Lines.....	383
Trace Style: Polygon.....	383

Select Trace

See "Selecting a trace" on page 114 and "Selecting a second trace" on page 114.

Remote command:

DISPlay<n>[:WINDow]:TRACe<t>[:STATe] on page 268

Trace Mode

See "Selecting the trace mode" on page 116.

(Supported trace modes: clear / Write, max hold, min hold and average.)

Remote command:

Trace mode: `DISPlay<n>[:WINDow]:TRACe<t>:MODE` on page 267

of averages: `[SENSe:]SWEep:COUNT` on page 270

Detector

See Chapter 15.6, "Trace Configuration", on page 144.

(Supported detectors: max peak, quasi peak, average and RMS.)

Remote command:

Detector: `[SENSe:]DETECTOR<t>[:FUNCTion]` on page 300

Memory

See "Working with memory traces" on page 117.

Remote command:

`CALCulate<n>:MATH<t>:COPY:MEMory` on page 266

Trace ► Memory

See "Working with memory traces" on page 117.

Remote command:

`DISPlay<n>[:WINDow]:TRACe<t>:MEMory[:STATe]` on page 267

Trace Style: Lines

See "Selecting the trace style" on page 137.

Remote command:

`DISPlay[:WINDow]:TRACe:STYLE` on page 301

Trace Style: Polygon

See "Selecting the trace style" on page 137.

Remote command:

`DISPlay[:WINDow]:TRACe:STYLE` on page 301

20.5.7 Lines Menu

Access: [Lines]

Show Limit Lines.....	383
Upper Limit.....	384
Lower Limit.....	384
Select Trace <x>.....	384
Audio Beep.....	384

Show Limit Lines

See "Hiding a limit line" on page 132.

Remote command:
not supported

Upper Limit

See ["Selecting a limit line"](#) on page 131, ["Using a threshold line"](#) on page 131 and ["Removing limit lines"](#) on page 132.

Remote command:

Threshold line: `CALCulate<n>:LIMit<k>:UPPer:THReshold` on page 295

Custom line: `CALCulate<n>:LIMit<k>:UPPer:SElect` on page 294

Removal: `CALCulate<n>:LIMit<k>:DElete` on page 291

Limit check: `CALCulate<n>:LIMit<k>:FAIL?` on page 291

Lower Limit

See ["Selecting a limit line"](#) on page 131, ["Using a threshold line"](#) on page 131 and ["Removing limit lines"](#) on page 132.

Remote command:

Threshold line: `CALCulate<n>:LIMit<k>:LOWer:THReshold` on page 292

Custom line: `CALCulate<n>:LIMit<k>:LOWer:SElect` on page 292

Removal: `CALCulate<n>:LIMit<k>:DElete` on page 291

Limit check: `CALCulate<n>:LIMit<k>:FAIL?` on page 291

Select Trace <x>

["Selecting a trace for the limit check"](#) on page 145

Remote command:
not supported

Audio Beep

See ["Performing limit checks"](#) on page 132.

Remote command:

`CALCulate<n>:LIMit<k>:BEEP[:STATE]` on page 289

20.5.8 Marker Menu

Access: [Mkr]

Marker <x>	384
Marker Type	385
Marker To Fixed Freq	385
Marker Demodulation	385
Marker Display	385
All Markers Off	385

Marker <x>

See ["Positioning a marker"](#) on page 121 and ["Adding additional markers"](#) on page 121.

(Only for frequency scan.)

Remote command:

Marker state: `CALCulate<n>:MARKer<m>[:STATe]` on page 278

Marker position (x-axis): `CALCulate<n>:MARKer<m>:X` on page 279

Marker position (y-axis): `CALCulate<n>:MARKer<m>:Y?` on page 281

Delta marker state: `CALCulate<n>:DELTamarker<m>[:STATe]` on page 273

Delta marker position (x-axis): `CALCulate<n>:DELTamarker<m>:X` on page 273

Delta marker position (relative): `CALCulate<n>:DELTamarker<m>:X:RELative` on page 274

Delta marker position (y-axis): `CALCulate<n>:DELTamarker<m>:Y?` on page 275

Marker Type

See "Selecting the marker type" on page 122.

(Only for frequency scan.)

Remote command:

With corresponding syntax `MARKer` or `DELTamarker`

Marker To Fixed Freq

See "Synchronizing the bargraph frequency and marker position" on page 146.

(Only for frequency scan.)

Remote command:

`CALCulate<n>:MARKer<m>:FUNction:FIXed` on page 303

Marker Demodulation

See Chapter 14.10.4, "Marker Demodulation", on page 128.

Remote command:

State: `CALCulate<n>:MARKer<m>:FUNction:DEModulation[:STATe]` on page 284

Modulation: `CALCulate<n>:MARKer<m>:FUNction:DEModulation:SElect` on page 283

Demodulation time: `CALCulate<n>:MARKer<m>:FUNction:DEModulation:HOLD` on page 283

Volume: `SYSTem:AUDio:VOLume` on page 287

Marker Display

See "Selecting the marker display type" on page 122.

Remote command:

`CALCulate<n>:MARKer<m>:FREQuency:MODE` on page 276

All Markers Off

See "Removing markers or delta markers" on page 122.

Remote command:

Markers: `CALCulate<n>:MARKer<m>:AOFF` on page 275

Delta markers: `CALCulate<n>:DELTamarker<m>:AOFF` on page 271

20.5.9 Marker To Menu

Access: [Mkr →]

Set To Peak.....	386
Set To Next Peak.....	386
Set To Minimum.....	386
All Markers To Peak.....	386
Center = Marker / Level = Marker.....	386
Marker Tracking.....	386
Select Marker.....	387
Search Range.....	387

Set To Peak

See "Positioning markers automatically" on page 123.

Remote command:

Marker: `CALCulate<n>:MARKer<m>:MAXimum[:PEAK]` on page 277

Delta marker: `CALCulate<n>:DELTamarker<m>:MAXimum[:PEAK]` on page 272

Set To Next Peak

See "Positioning markers automatically" on page 123.

Remote command:

Marker: `CALCulate<n>:MARKer<m>:MAXimum:NEXT` on page 277

Delta marker: `CALCulate<n>:DELTamarker<m>:MAXimum:NEXT` on page 272

Set To Minimum

See "Positioning markers automatically" on page 123.

Remote command:

Marker: `CALCulate<n>:MARKer<m>:MINimum[:PEAK]` on page 278

Delta marker: `CALCulate<n>:DELTamarker<m>:MINimum[:PEAK]` on page 273

All Markers To Peak

See "Positioning markers automatically" on page 123.

Remote command:

not supported

Center = Marker / Level = Marker

See "Positioning markers automatically" on page 123.

Remote command:

Center = marker frequency: `CALCulate<n>:MARKer<m>:FUNction:CENTer`
on page 276

Ref level = marker level: `CALCulate<n>:MARKer<m>:FUNction:REFerence`
on page 276

Marker Tracking

See "Keeping the marker on the peak" on page 124.

Remote command:

`CALCulate<n>:MARKer<m>:FUNction:STRack[:STATe]` on page 277

Select Marker

See ["Selecting a marker"](#) on page 123.

Remote command:

With suffix at `MARKer` or `DELTAmarker`

Search Range

See ["Defining marker search range"](#) on page 124.

Remote command:

Search range: `CALCulate<n>:MARKer<m>:X:SLIMits<slim>[:STATe]`
on page 280

Left limit: `CALCulate<n>:MARKer<m>:X:SLIMits<slim>:LEFT` on page 279

Right limit: `CALCulate<n>:MARKer<m>:X:SLIMits<slim>:RIGHT` on page 280

20.6 Function Reference: Analog Demodulation

Access: [Mode] > "Analog Demod"

- [Measurement Menu](#)..... 387
- [Frequency Menu](#)..... 388
- [Amplitude Menu](#)..... 388
- [Bandwidth Menu](#)..... 389
- [Sweep Menu](#)..... 390
- [Lines Menu](#)..... 390

20.6.1 Measurement Menu

Access: [Meas]

- [AM Domain](#)..... 387
- [FM Domain](#)..... 387
- [Audio Lowpass](#)..... 387
- [Mod. Trace](#)..... 388
- [Mod. Summary](#)..... 388

AM Domain

See ["Selecting the measurement"](#) on page 147.

Remote command:

`CALCulate<n>:FEED` on page 304

FM Domain

See ["Selecting the measurement"](#) on page 147.

Remote command:

`CALCulate<n>:FEED` on page 304

Audio Lowpass

["Selecting the audio lowpass filter"](#) on page 152

Remote command:

[SENSe:] FILTER:LPASs on page 311

Mod. Trace

See "Selecting the result display" on page 148.

Remote command:

CALCulate<n>:FEED on page 304

Mod. Summary

See "Selecting the result display" on page 148.

Remote command:

CALCulate<n>:FEED on page 304

20.6.2 Frequency Menu

Access: [Freq]

Center Frequency.....	388
Center Freq Step Size.....	388

Center Frequency

See "Defining a center frequency" on page 94.

Remote command:

[SENSe:] FREQuency:CENTer on page 248

Center Freq Step Size

See "Defining a frequency step size" on page 94.

Remote command:

[SENSe:] FREQuency:CENTer:STEP on page 248

20.6.3 Amplitude Menu

Access: [Ampt]

Reference Level.....	388
Deviation per Division.....	389
Scale Adjust.....	389
Preamplifier.....	389
Attenuator.....	389
Impedance.....	389

Reference Level

See "Defining a reference level" on page 99.

Remote command:

DISPlay<n>[:WINDow]:TRACe<t>:Y[:SCALE]:RLEVEL on page 253

Deviation per Division

See ["Adjusting the scale of the y-axis \(AM signals\)"](#) on page 151 and ["Adjusting the scale of the y-axis \(FM signals\)"](#) on page 151.

Remote command:

`DISPlay<n>[:WINDow]:TRACe<t>:Y[:SCALe]:PDIVision` on page 309

Scale Adjust

See ["Adjusting the scale of the y-axis \(FM signals\)"](#) on page 151.

(Only for measurements on FM signals.)

Remote command:

not supported

Preamplifier

See ["Turning the preamplifier on and off"](#) on page 103.

Remote command:

`INPut:GAIN:STATe` on page 256

Attenuator

See ["Defining RF attenuation"](#) on page 101.

Remote command:

Attenuation: `INPut:ATTenuation` on page 255

Automatic attenuation: `INPut:ATTenuation:AUTO` on page 255

Attenuation mode: `INPut:ATTenuation:MODE` on page 256

Impedance

See ["Selecting the input impedance"](#) on page 98.

Remote command:

Impedance: `INPut:IMPedance` on page 256

Matching pad: `INPut:IMPedance:PAD` on page 257

20.6.4 Bandwidth Menu

Access: [BW]

Manual DBW	389
FM Broadcast	389
Reference Deviation	390

Manual DBW

See ["Selecting the demodulation bandwidth"](#) on page 152.

Remote command:

`[SENSe:]ADEMod:BANDwidth:DEModulation` on page 310

FM Broadcast

See ["Selecting the FM broadcast time"](#) on page 153.

Remote command:

Filter: [\[SENSe:\]FILTer:DEMPHasis\[:STATE\]](#) on page 310

Time constant: [\[SENSe:\]FILTer:DEMPHasis:TCONstant](#) on page 311

Reference Deviation

See ["Defining the FM frequency deviation"](#) on page 153.

Remote command:

[\[SENSe:\]ADEMod:BANDwidth:RDEVIation](#) on page 310

20.6.5 Sweep Menu

Access: [Sweep]

Continuous Measurement	390
Single Measurement	390

Continuous Measurement

See ["Selecting the measurement mode"](#) on page 156.

Remote command:

Measurement mode: [INITiate:CONTInuous](#) on page 262

Start measurement: [INITiate\[:IMMediate\]](#) on page 263

Single Measurement

See ["Selecting the measurement mode"](#) on page 156.

Remote command:

Sweep measurement: [INITiate:CONTInuous](#) on page 262

Start measurement: [INITiate\[:IMMediate\]](#) on page 263

20.6.6 Lines Menu

Access: [Lines]

Select Limits	390
Clear Limits	390
Audio Beep	391

Select Limits

See ["Selecting and evaluating limits"](#) on page 156.

Remote command:

[CALCulate<n>:ADEMod:LIMit:SElect](#) on page 313

Clear Limits

See ["Removing limits"](#) on page 157.

Remote command:

[CALCulate<n>:ADEMod:LIMit:DElete](#) on page 312

Audio Beep

See ["Turning an audio signal in case of limit violation on and off"](#) on page 157.

Remote command:

[CALCulate<n>:LIMit<k>:BEEP\[:STATe\]](#) on page 289

20.7 Function Reference: Digital Demodulation

Access: [Mode] > "Digital Demod"

• Measurement Menu	391
• Frequency Menu	392
• Amplitude Menu	393
• Sweep Menu	394
• Trace Menu	394
• Marker Menu	395

20.7.1 Measurement Menu

Access: [Meas]

ASK	391
FSK	391
Demod Parameters	391
Standard	392
Eye Diagram	392
Symbols	392
Modulation Depth / Modulation Deviation	392
Modulation Error	392

ASK

See ["Selecting the measurement"](#) on page 159.

Remote command:

[\[SENSe:\] DDEMod](#) on page 317

FSK

See ["Selecting the measurement"](#) on page 159.

Remote command:

[\[SENSe:\] DDEMod](#) on page 317

Demod Parameters

- ["Selecting the filter type"](#) on page 164
- ["Defining the symbol rate"](#) on page 165
- ["Defining the roll-off factor of the measurement filter"](#) on page 164
- ["Defining the number of signal symbols"](#) on page 165
- ["Turning burst processing on and off"](#) on page 165

Remote command:

Filter state: [\[SENSe:\] DDEMod: FILTER\[:STATE\]](#) on page 319

Filter type: [\[SENSe:\] DDEMod: FILTER:NAME](#) on page 319

Symbol rate: [\[SENSe:\] DDEMod: SRATE](#) on page 320

Alpha / BT: [\[SENSe:\] DDEMod: FILTER:ALPHA](#) on page 318

Number of symbols: [\[SENSe:\] DDEMod: TIME](#) on page 320

Burst processing: [\[SENSe:\] DDEMod: BURSt\[:STATE\]](#) on page 318

Standard

See ["Selecting a standard"](#) on page 166.

Remote command:

not supported

Eye Diagram

See ["Selecting the result display"](#) on page 160.

Remote command:

[CALCulate<n>:FEED](#) on page 313

Symbols

See ["Selecting the result display"](#) on page 160.

Remote command:

[CALCulate<n>:FEED](#) on page 313

Modulation Depth / Modulation Deviation

See ["Selecting the result display"](#) on page 160.

Remote command:

[CALCulate<n>:FEED](#) on page 313

Modulation Error

See ["Selecting the result display"](#) on page 160.

Remote command:

[CALCulate<n>:FEED](#) on page 313

20.7.2 Frequency Menu

Access: [Freq]

Center Frequency	392
Center Freq Step Size	393
Frequency Offset	393

Center Frequency

See ["Defining a center frequency"](#) on page 94.

Remote command:

[\[SENSe:\] FREquency: CENTer](#) on page 248

Center Freq Step Size

See "Defining a frequency step size" on page 94.

Remote command:

[SENSe:] FREQuency:CENTer:STEP on page 248

Frequency Offset

See "Defining a frequency offset" on page 95.

Remote command:

[SENSe:] FREQuency:OFFSet on page 250

20.7.3 Amplitude Menu

Access: [Ampt]

Reference Level.....	393
Deviation per Division.....	393
Ref Position.....	393
Preamplifier.....	393
Attenuator.....	393

Reference Level

See "Defining a reference level" on page 99.

Remote command:

DISPlay<n>[:WINDow]:TRACe<t>:Y[:SCALe]:RLEVel on page 253

Deviation per Division

See "Adjusting the scale of the y-axis" on page 167.

Remote command:

DISPlay<n>[:WINDow]:TRACe<t>:Y[:SCALe]:PDIVision on page 321

Ref Position

See "Defining the position of the reference (ASK signals)" on page 167.

(Only for ASK measurements.)

Remote command:

DISPlay<n>[:WINDow]:TRACe<t>:Y[:SCALe]:RPOSition on page 321

Preamplifier

See "Turning the preamplifier on and off" on page 103.

Remote command:

INPut:GAIN:STATe on page 256

Attenuator

See "Defining RF attenuation" on page 101.

Remote command:

Attenuation: `INPut:ATTenuation` on page 255

Automatic attenuation: `INPut:ATTenuation:AUTO` on page 255

Attenuation mode: `INPut:ATTenuation:MODE` on page 256

20.7.4 Sweep Menu

Access: [Sweep]

Continuous Measurement	394
Single Measurement	394
Trigger	394

Continuous Measurement

See "[Selecting the measurement mode](#)" on page 156.

Remote command:

Measurement mode: `INITiate:CONTInuous` on page 262

Start measurement: `INITiate[:IMMediate]` on page 263

Single Measurement

See "[Selecting the measurement mode](#)" on page 156.

Remote command:

Sweep measurement: `INITiate:CONTInuous` on page 262

Start measurement: `INITiate[:IMMediate]` on page 263

Trigger

See "[Selecting the trigger source](#)" on page 112, "[Defining a trigger delay](#)" on page 113 and "[Using the I/Q power trigger](#)" on page 169.

Remote command:

Trigger source: `TRIGger[:SEQuence]:SOURce` on page 322

I/Q power: `TRIGger[:SEQuence]:LEVel:IQPower` on page 322

Trigger slope (external): `TRIGger[:SEQuence]:SLOPe` on page 264

Delay (external): `TRIGger[:SEQuence]:HOLDoff[:TIME]` on page 264

20.7.5 Trace Menu

Access: [Trace]

Memory	394
Trace ► Memory	395

Memory

See "[Working with memory traces](#)" on page 117.

(Only one trace available in digital demodulation.)

Remote command:

`CALCulate<n>:MATH<t>:COPY:MEMory` on page 266

Trace ► Memory

See ["Working with memory traces"](#) on page 117.

(Only one trace available in digital demodulation.)

Remote command:

`DISPlay<n>[:WINDow]:TRACe<t>:MEMory[:STATe]` on page 267

20.7.6 Marker Menu

Access: [Mkr]

Marker <x>	395
Marker Type	395
All Markers Off	395

Marker <x>

See ["Positioning a marker"](#) on page 121 and ["Adding additional markers"](#) on page 121.

Remote command:

Marker state: `CALCulate<n>:MARKer<m>[:STATe]` on page 278

Marker position (x-axis): `CALCulate<n>:MARKer<m>:X` on page 279

Marker position (y-axis): `CALCulate<n>:MARKer<m>:Y?` on page 281

Delta marker state: `CALCulate<n>:DELTamarker<m>[:STATe]` on page 273

Delta marker position (x-axis): `CALCulate<n>:DELTamarker<m>:X` on page 273

Delta marker position (relative): `CALCulate<n>:DELTamarker<m>:X:RELative` on page 274

Delta marker position (y-axis): `CALCulate<n>:DELTamarker<m>:Y?` on page 275

Marker Type

See ["Selecting the marker type"](#) on page 122.

Remote command:

With corresponding syntax `MARKer` or `DELTamarker`

All Markers Off

See ["Removing markers or delta markers"](#) on page 122.

Remote command:

Markers: `CALCulate<n>:MARKer<m>:AOFF` on page 275

Delta markers: `CALCulate<n>:DELTamarker<m>:AOFF` on page 271

20.8 Function Reference: Vector Network Analyzer

Access: [Mode] > "VNA"

• Measurement Menu	396
• Frequency Menu	398
• Span Menu	399
• Amplitude Menu	399
• Bandwidth Menu	400

• Sweep Menu.....	400
• Trace Menu.....	401
• Lines Menu.....	402
• Marker Menu.....	403
• Marker To Menu.....	403

20.8.1 Measurement Menu

Access: [Meas]

Reflection S11.....	396
Transmission S21.....	396
1-Port Cable Loss.....	396
Distance To Fault.....	396
Format.....	396
Phase.....	397
Calibrate.....	397
DTF Config.....	397
L Select Cable Model.....	397
L Clear Cable Model.....	397
L Define User Model.....	397
L DTF List.....	397
L DTF List Threshold.....	397

Reflection S11

See "[Measuring the reflection](#)" on page 172.

Remote command:

`MEASurement<n>:MODE` on page 324

Transmission S21

See "[Measuring the transmission](#)" on page 171.

Remote command:

`MEASurement<n>:MODE` on page 324

1-Port Cable Loss

See "[Measuring the cable loss](#)" on page 173.

Remote command:

`MEASurement<n>:MODE` on page 324

Distance To Fault

See "[Measuring the distance to fault](#)" on page 174.

Remote command:

`MEASurement<n>:MODE` on page 324

Format

See "[Selecting the measurement format](#)" on page 175.

Remote command:

`MEASurement<n>:FORMat` on page 324

Phase

See ["Unwrapping the phase"](#) on page 176 and ["Displaying the electrical length of the DUT"](#) on page 176.

Remote command:

Phase unwrapping: `DISPlay<n>:PHASe:UNWRap` on page 333

Calibrate

See [Chapter 12, "Calibration"](#), on page 54.

Remote command:

Start calibration: `CALibration<n>:START?` on page 230

Continue: `CALibration<n>:CONTINUE?` on page 229

Abort calibration: `CALibration<n>:ABORT` on page 228

Query state: `CALibration<n>:STATus?` on page 231

Query type: `CALibration<n>:MODE?` on page 229

DTF Config

See [Chapter 18.1.6, "DTF Configuration"](#), on page 177

(Distance to fault measurements only.)

Select Cable Model ← DTF Config

See ["Selecting a predefined cable model"](#) on page 177.

Remote command:

`CALCulate<n>:DTF:CABLE:PRESet` on page 325

Clear Cable Model ← DTF Config

See ["Selecting a predefined cable model"](#) on page 177.

Remote command:

`CALCulate<n>:DTF:CABLE:PRESet` on page 325

Define User Model ← DTF Config

See ["Creating a custom cable model"](#) on page 178.

Remote command:

not supported

DTF List ← DTF Config

See ["Displaying the DTF list"](#) on page 174.

Remote command:

`CALCulate<n>:TRANSform:DTFault:PEAK[:STATE]` on page 327

DTF List Threshold ← DTF Config

See ["Displaying the DTF list"](#) on page 174.

Remote command:

`CALCulate<n>:TRANSform:DTFault:PEAK:THReshold` on page 328

20.8.2 Frequency Menu

Access: [Freq]

Start Distance.....	398
Stop Distance.....	398
Center Frequency.....	398
Start Frequency.....	398
Stop Frequency.....	398
Signal Standard.....	398

Start Distance

See "Defining the cable length" on page 179.

(Distance to fault measurements only.)

Remote command:

`CALCulate<n>:DTF:DISTance:START` on page 326

Stop Distance

See "Defining the cable length" on page 179.

(DTF measurements only.)

Remote command:

`CALCulate<n>:DTF:DISTance:STOP` on page 326

Center Frequency

See "Defining a center frequency" on page 94.

Remote command:

`[SENSe:]FREQuency:CENTer` on page 248

Start Frequency

See "Defining a start and stop frequency" on page 97.

Remote command:

`[SENSe:]FREQuency:START` on page 251

Stop Frequency

See "Defining a start and stop frequency" on page 97.

Remote command:

`[SENSe:]FREQuency:STOP` on page 251

Signal Standard

See "Working with channel tables" on page 97.

(Not for distance to fault measurements.)

Remote command:

Input mode: `[SENSe:]FREQuency:INPut:MODE` on page 249

Channel table (DL): `[SENSe:]CHANnel:TABLE:SElect:DOWNlink` on page 246

Channel table (UL): `[SENSe:]CHANnel:TABLE:SElect:UPLink` on page 246

20.8.3 Span Menu

Access: [Span]

Manual Span

See "Defining the frequency span" on page 96.

Remote command:

State: [SENSe:] FREQuency: SPAN: AUTO on page 336

Span: [SENSe:] FREQuency: SPAN on page 250

Full Span

See "Defining the frequency span" on page 96.

(Not for distance to fault measurements.)

Remote command:

[SENSe:] FREQuency: SPAN: FULL on page 251

Coupled Span

See "Coupling frequency and span settings across measurements" on page 180.

(Distance to fault measurements only.)

Remote command:

[SENSe:] FREQuency: SETTings: COUPling: ENABle on page 335

20.8.4 Amplitude Menu

Access: [Ampt]

Reference Level.....	399
Range / Ref Position.....	399
Auto Range.....	400
Full Scale	400

Reference Level

See "Defining the reference value" on page 181.

Remote command:

Cable loss format: DISPlay<n>: LOSS: REFerence on page 329

Return loss format: DISPlay<n>: MAGNitude: REFerence on page 330

Phase format: DISPlay<n>: PHASe: REFerence on page 332

Range / Ref Position

See "Defining the position of the reference line" on page 181 and "Defining the display range" on page 182.

Remote command:

Ref position (cable loss): DISPlay<n>: LOSS: REFerence: POSition on page 329

Ref position (return loss): DISPlay<n>: MAGNitude: REFerence: POSition
on page 330

Ref position (phase): DISPlay<n>: PHASe: REFerence: POSition on page 332

Range (cable loss): DISPlay<n>: LOSS: Y: SCALe on page 329

Range (return loss): [DISPlay<n>:MAGNitude:Y:SCALe](#) on page 331
 Range (phase): [DISPlay<n>:PHASe:Y:SCALe](#) on page 333
 Range (SWR): [DISPlay<n>:VSWR:Y:SCALe](#) on page 334
 Range (SWR): [DISPlay<n>:VSWR:Y:SCALe:MINimum](#) on page 335
 Range (SWR): [DISPlay<n>:VSWR:Y:SCALe:MAXimum](#) on page 334
 Y-axis scale (return loss): [DISPlay<n>:MAGNitude:Y:SPACing](#) on page 331

Auto Range

See ["Defining the display range"](#) on page 182.

Remote command:

[DISPlay<n>\[:WINDow\]:TRACe<t>:Y\[:SCALe\]:ADJusT](#) on page 253

Full Scale

See ["Defining the display range"](#) on page 182.

Remote command:

not supported

20.8.5 Bandwidth Menu

Access: [BW]

[RBW: Manual](#)..... 400
[RBW: Auto](#)..... 400

RBW: Manual

See ["Defining the measurement bandwidth"](#) on page 182.

Remote command:

[\[SENSe:\]BANDwidth\[:RESolution\]](#) on page 259

RBW: Auto

See ["Defining the measurement bandwidth"](#) on page 182.

Remote command:

[\[SENSe:\]BANDwidth\[:RESolution\]:AUTO](#) on page 260

20.8.6 Sweep Menu

Access: [Sweep]

[Continuous Sweep](#)..... 400
[Single Sweep](#)..... 401
[Hold](#)..... 401
[Number of Points](#)..... 401

Continuous Sweep

See ["Selecting the measurement mode"](#) on page 183.

Remote command:

Sweep mode: `INITiate:CONTinuous` on page 262

Start sweep: `INITiate[:IMMediate]` on page 263

Single Sweep

See "Selecting the measurement mode" on page 183.

Remote command:

Sweep mode: `INITiate:CONTinuous` on page 262

Start sweep: `INITiate[:IMMediate]` on page 263

Hold

See "Selecting the measurement mode" on page 183.

Remote command:

not supported

Number of Points

See "Defining the number of measurement points" on page 184.

Remote command:

`[SENSe:]SWEep:POINTs` on page 337

20.8.7 Trace Menu

Access: [Trace]

Trace Mode.....	401
Memory.....	401
Trace ► Memory.....	401
Trace Math.....	402

Trace Mode

See "Selecting the trace mode" on page 116.

Remote command:

Trace mode: `DISPlay<n>[:WINDow]:TRACe<t>:MODE` on page 267

of averages: `[SENSe:]SWEep:COUNT` on page 270

Memory

See "Working with memory traces" on page 117.

(Only one trace available in VNA.)

Remote command:

`CALCulate<n>:MATH<t>:COPY:MEMory` on page 266

Trace ► Memory

See "Working with memory traces" on page 117.

(Only one trace available in VNA.)

Remote command:

`DISPlay<n>[:WINDow]:TRACe<t>:MEMory[:STATe]` on page 267

Trace Math

See ["Using trace mathematics"](#) on page 118.

Remote command:

State: `CALCulate<n>:MATH<t>:STATe` on page 267

Operation: `CALCulate<n>:MATH<t>[:EXPRession] [:DEFine]` on page 266

20.8.8 Lines Menu

Access: [Lines]

Display Line	402
Show Limit Lines	402
Upper Limit	402
Lower Limit	402
Audio Beep	402

Display Line

See ["Using a display line"](#) on page 129.

Remote command:

State: `CALCulate<n>:DLINe:STATe` on page 288

Position: `CALCulate<n>:DLINe` on page 288

Show Limit Lines

See ["Hiding a limit line"](#) on page 132.

Remote command:

not supported

Upper Limit

See ["Selecting a limit line"](#) on page 131, ["Using a threshold line"](#) on page 131 and ["Removing limit lines"](#) on page 132.

Remote command:

Threshold line: `CALCulate<n>:LIMit<k>:UPPer:THReshold` on page 295

Custom line: `CALCulate<n>:LIMit<k>:UPPer:SElect` on page 294

Removal: `CALCulate<n>:LIMit<k>:DElete` on page 291

Limit check: `CALCulate<n>:LIMit<k>:FAIL?` on page 291

Lower Limit

See ["Selecting a limit line"](#) on page 131, ["Using a threshold line"](#) on page 131 and ["Removing limit lines"](#) on page 132.

Remote command:

Threshold line: `CALCulate<n>:LIMit<k>:LOWer:THReshold` on page 292

Custom line: `CALCulate<n>:LIMit<k>:LOWer:SElect` on page 292

Removal: `CALCulate<n>:LIMit<k>:DElete` on page 291

Limit check: `CALCulate<n>:LIMit<k>:FAIL?` on page 291

Audio Beep

See ["Performing limit checks"](#) on page 132.

Remote command:

`CALCulate<n>:LIMit<k>:BEEP[:STATe]` on page 289

20.8.9 Marker Menu

Access: [Mkr]

Marker <x>.....	403
Marker Type.....	403
Marker Mode.....	403
All Markers Off.....	403

Marker <x>

See ["Positioning a marker"](#) on page 121 and ["Adding additional markers"](#) on page 121.

Remote command:

Marker state: `CALCulate<n>:MARKer<m>[:STATe]` on page 278

Marker position (x-axis): `CALCulate<n>:MARKer<m>:X` on page 279

Marker position (y-axis): `CALCulate<n>:MARKer<m>:Y?` on page 339

Delta marker state: `CALCulate<n>:DELTamarker<m>[:STATe]` on page 273

Delta marker position (x-axis): `CALCulate<n>:DELTamarker<m>:X` on page 273

Delta marker position (relative): `CALCulate<n>:DELTamarker<m>:X:RELative` on page 274

Delta marker position (y-axis): `CALCulate<n>:DELTamarker<m>:Y?` on page 275

Marker Type

See ["Selecting the marker type"](#) on page 122.

Remote command:

With corresponding syntax `MARKer` or `DELTamarker`

Marker Mode

See ["Using markers in the Smith diagram"](#) on page 185.

(Only in Smith diagrams.)

Remote command:

Mode: `CALCulate<n>:MARKer<m>:MODE` on page 338

Reference impedance: `DISPlay<n>:IMPedance:REFerence:POSition` on page 340

All Markers Off

See ["Removing markers or delta markers"](#) on page 122.

Remote command:

Markers: `CALCulate<n>:MARKer<m>:AOFF` on page 275

Delta markers: `CALCulate<n>:DELTamarker<m>:AOFF` on page 271

20.8.10 Marker To Menu

Access: [Mkr →]

Set To Peak.....	404
Set To Next Peak.....	404
Set To Minimum.....	404
All Markers To Peak.....	404
Center = Marker / Level = Marker.....	404
Marker Tracking.....	404
Select Marker.....	404
Search Range.....	405

Set To Peak

See "Positioning markers automatically" on page 123.

Remote command:

Marker: `CALCulate<n>:MARKer<m>:MAXimum[:PEAK]` on page 277

Delta marker: `CALCulate<n>:DELTamarker<m>:MAXimum[:PEAK]` on page 272

Set To Next Peak

See "Positioning markers automatically" on page 123.

Remote command:

Marker: `CALCulate<n>:MARKer<m>:MAXimum:NEXT` on page 277

Delta marker: `CALCulate<n>:DELTamarker<m>:MAXimum:NEXT` on page 272

Set To Minimum

See "Positioning markers automatically" on page 123.

Remote command:

Marker: `CALCulate<n>:MARKer<m>:MINimum[:PEAK]` on page 278

Delta marker: `CALCulate<n>:DELTamarker<m>:MINimum[:PEAK]` on page 273

All Markers To Peak

See "Positioning markers automatically" on page 123.

Remote command:

not supported

Center = Marker / Level = Marker

See "Positioning markers automatically" on page 123.

Remote command:

Center = marker frequency: `CALCulate<n>:MARKer<m>:FUNCTION:CENTer`
on page 276

Ref level = marker level: `CALCulate<n>:MARKer<m>:FUNCTION:REFerence`
on page 276

Marker Tracking

See "Keeping the marker on the peak" on page 124.

Remote command:

`CALCulate<n>:MARKer<m>:FUNCTION:STRack[:STATE]` on page 277

Select Marker

See "Selecting a marker" on page 123.

Remote command:

With suffix at `MARKer` or `DELtmarker`

Search Range

See "[Defining marker search range](#)" on page 124.

Remote command:

Search range: `CALCulate<n>:MARKer<m>:X:SLIMits<slim>[:STATe]`
on page 280

Left limit: `CALCulate<n>:MARKer<m>:X:SLIMits<slim>:LEFT` on page 279

Right limit: `CALCulate<n>:MARKer<m>:X:SLIMits<slim>:RIGHT` on page 280

List of Commands

[SENSe:]ADEMod:BANDwidth:DEModulation.....	310
[SENSe:]ADEMod:BANDwidth:RDEVIation.....	310
[SENSe:]ADEMod:BWIDth:DEModulation.....	310
[SENSe:]ADEMod:BWIDth:RDEVIation.....	310
[SENSe:]ADEMod:FM:OFFSet?.....	308
[SENSe:]ADEMod:MTIME?.....	311
[SENSe:]BANDwidth:VIDeo.....	260
[SENSe:]BANDwidth:VIDeo:AUTO.....	260
[SENSe:]BANDwidth[:RESolution].....	259
[SENSe:]BANDwidth[:RESolution]:AUTO.....	260
[SENSe:]BANDwidth[:RESolution]:CISPr.....	299
[SENSe:]BANDwidth[:RESolution]:CISPr:AUTO.....	300
[SENSe:]BWIDth:VIDeo.....	260
[SENSe:]BWIDth:VIDeo:AUTO.....	260
[SENSe:]BWIDth[:RESolution].....	259
[SENSe:]BWIDth[:RESolution]:AUTO.....	260
[SENSe:]CHANnel.....	246
[SENSe:]CHANnel:TABLE:SElect.....	247
[SENSe:]CHANnel:TABLE:SElect:DOWNlink.....	246
[SENSe:]CHANnel:TABLE:SElect:UPLink.....	246
[SENSe:]CHANnel:TABLE:SET.....	247
[SENSe:]CORRection:TRANsdUcer<td>:SElect.....	257
[SENSe:]CORRection:TRANsdUcer<td>:UNIT?.....	258
[SENSe:]CORRection:TRANsdUcer<td>[:STATE].....	258
[SENSe:]DDEMod.....	317
[SENSe:]DDEMod:BURSt[:STATE].....	318
[SENSe:]DDEMod:FILTer:ALPHa.....	318
[SENSe:]DDEMod:FILTer:NAME.....	319
[SENSe:]DDEMod:FILTer[:STATE].....	319
[SENSe:]DDEMod:FSK:OFFSet?.....	317
[SENSe:]DDEMod:SRATE.....	320
[SENSe:]DDEMod:TIME.....	320
[SENSe:]DETEctor<t>[:FUNction].....	269
[SENSe:]DETEctor<t>[:FUNction].....	300
[SENSe:]DETEctor<t>[:FUNction]:AUTO.....	270
[SENSe:]FILTer:DEMPHasis:TCONstant.....	311
[SENSe:]FILTer:DEMPHasis[:STATE].....	310
[SENSe:]FILTer:LPASs.....	311
[SENSe:]FREQuency:CENTer.....	248
[SENSe:]FREQuency:CENTer.....	297
[SENSe:]FREQuency:CENTer:STEP.....	248
[SENSe:]FREQuency:CENTer:STEP:LINK.....	248
[SENSe:]FREQuency:INPut:MODE.....	249
[SENSe:]FREQuency:MODE.....	249
[SENSe:]FREQuency:MODE.....	296
[SENSe:]FREQuency:OFFSet.....	250
[SENSe:]FREQuency:SETTings:COUPLing:ENABLE.....	335

[SENSe:]FREQuency:SPAN.....	250
[SENSe:]FREQuency:SPAN:AUTO.....	336
[SENSe:]FREQuency:SPAN:FULL.....	251
[SENSe:]FREQuency:StARt.....	251
[SENSe:]FREQuency:StOP.....	251
[SENSe:]SCAN:StARt.....	297
[SENSe:]SCAN:StEP.....	297
[SENSe:]SCAN:StOP.....	298
[SENSe:]SWEep:COUnT.....	270
[SENSe:]SWEep:POINts.....	337
[SENSe:]SWEep:SPACing.....	298
[SENSe:]SWEep:TIME.....	261
[SENSe:]SWEep:TIME:AUTO.....	262
*CLS.....	203
*ESE.....	203
*ESR?.....	203
*IDN?.....	203
*IST?.....	204
*OPC.....	204
*OPT?.....	204
*RST.....	204
*SRE.....	204
*STB?.....	205
*TRG.....	205
*TST?.....	205
*WAI.....	205
ABORt.....	261
CALCulate<n>:ADEMod:LIMit:DELeTe.....	312
CALCulate<n>:ADEMod:LIMit:FAIL?.....	312
CALCulate<n>:ADEMod:LIMit:SELeCt.....	313
CALCulate<n>:DELtAmarker<m>:AOFF.....	271
CALCulate<n>:DELtAmarker<m>:MAXimum:NEXt.....	272
CALCulate<n>:DELtAmarker<m>:MAXimum[:PEAK].....	272
CALCulate<n>:DELtAmarker<m>:MINimum[:PEAK].....	273
CALCulate<n>:DELtAmarker<m>:X.....	273
CALCulate<n>:DELtAmarker<m>:X:RELative.....	274
CALCulate<n>:DELtAmarker<m>:Y?.....	275
CALCulate<n>:DELtAmarker<m>[:STATe].....	273
CALCulate<n>:DLINe.....	288
CALCulate<n>:DLINe:STATe.....	288
CALCulate<n>:DTF:CABLe:PRESet.....	325
CALCulate<n>:DTF:DIStAnce:StARt.....	326
CALCulate<n>:DTF:DIStAnce:StOP.....	326
CALCulate<n>:FEED.....	304
CALCulate<n>:FEED.....	313
CALCulate<n>:LIMit<k>:BEEP[:STATe].....	289
CALCulate<n>:LIMit<k>:COMMeNt?.....	289
CALCulate<n>:LIMit<k>:DEFine.....	290
CALCulate<n>:LIMit<k>:DELeTe.....	291
CALCulate<n>:LIMit<k>:FAIL?.....	291

CALCulate<n>:LIMit<k>:LOWer:SElect.....	292
CALCulate<n>:LIMit<k>:LOWer:THReshold.....	292
CALCulate<n>:LIMit<k>:STATe.....	293
CALCulate<n>:LIMit<k>:UNIT:X?.....	293
CALCulate<n>:LIMit<k>:UNIT[:Y]?.....	294
CALCulate<n>:LIMit<k>:UPPer:SElect.....	294
CALCulate<n>:LIMit<k>:UPPer:THReshold.....	295
CALCulate<n>:MARKer:FUNCTion:ADEMod:AFRequency[:RESult]?.....	304
CALCulate<n>:MARKer:FUNCTion:ADEMod:AM[:RESult]?.....	305
CALCulate<n>:MARKer:FUNCTion:ADEMod:CARRier[:RESult]?.....	305
CALCulate<n>:MARKer:FUNCTion:ADEMod:FERRor[:RESult]?.....	305
CALCulate<n>:MARKer:FUNCTion:ADEMod:FM[:RESult]?.....	306
CALCulate<n>:MARKer:FUNCTion:ADEMod:MINDex[:RESult]?.....	306
CALCulate<n>:MARKer:FUNCTion:ADEMod:MRAT[:RESult]?.....	307
CALCulate<n>:MARKer:FUNCTion:ADEMod:SINad[:RESult]?.....	307
CALCulate<n>:MARKer:FUNCTion:ADEMod:THD[:RESult]?.....	307
CALCulate<n>:MARKer:FUNCTion:DDEMod:CARRier[:RESult]?.....	314
CALCulate<n>:MARKer:FUNCTion:DDEMod:CFDRift[:RESult]?.....	314
CALCulate<n>:MARKer:FUNCTion:DDEMod:CFERRor[:RESult]?.....	315
CALCulate<n>:MARKer:FUNCTion:DDEMod:MDEPth[:RESult]?.....	315
CALCulate<n>:MARKer:FUNCTion:DDEMod:MDEViation[:RESult]?.....	315
CALCulate<n>:MARKer:FUNCTion:DDEMod:MERRor[:RESult]?.....	316
CALCulate<n>:MARKer:FUNCTion:DDEMod:MINDex[:RESult]?.....	316
CALCulate<n>:MARKer:FUNCTion:DDEMod:MOERRor[:RESult]?.....	316
CALCulate<n>:MARKer:FUNCTion:DDEMod:MPOWer[:RESult]?.....	317
CALCulate<n>:MARKer<m>:AOFF.....	275
CALCulate<n>:MARKer<m>:COUNT:FREQuency?.....	282
CALCulate<n>:MARKer<m>:COUNT[:STATe].....	282
CALCulate<n>:MARKer<m>:FREQuency:MODE.....	276
CALCulate<n>:MARKer<m>:FUNCTion:CENTer.....	276
CALCulate<n>:MARKer<m>:FUNCTion:CPOWer:BANDwidth.....	237
CALCulate<n>:MARKer<m>:FUNCTion:CPOWer:MODE.....	237
CALCulate<n>:MARKer<m>:FUNCTion:CPOWer:UNIT.....	238
CALCulate<n>:MARKer<m>:FUNCTion:DEModulation:HOLD.....	283
CALCulate<n>:MARKer<m>:FUNCTion:DEModulation:SElect.....	283
CALCulate<n>:MARKer<m>:FUNCTion:DEModulation[:STATe].....	284
CALCulate<n>:MARKer<m>:FUNCTion:FIXed.....	303
CALCulate<n>:MARKer<m>:FUNCTion:HARMonics:DISTortion?.....	242
CALCulate<n>:MARKer<m>:FUNCTion:HARMonics:LIST?.....	242
CALCulate<n>:MARKer<m>:FUNCTion:HARMonics:NHARmonics.....	243
CALCulate<n>:MARKer<m>:FUNCTion:HARMonics:PRESet.....	243
CALCulate<n>:MARKer<m>:FUNCTion:HARMonics[:STATe].....	244
CALCulate<n>:MARKer<m>:FUNCTion:LEVel:ONCE.....	233
CALCulate<n>:MARKer<m>:FUNCTion:MDEPth:RESult?.....	244
CALCulate<n>:MARKer<m>:FUNCTion:MDEPth[:STATe].....	245
CALCulate<n>:MARKer<m>:FUNCTion:NDBDown.....	284
CALCulate<n>:MARKer<m>:FUNCTion:NDBDown:FREQuency?.....	285
CALCulate<n>:MARKer<m>:FUNCTion:NDBDown:RESult?.....	285
CALCulate<n>:MARKer<m>:FUNCTion:NDBDown:STATe.....	286
CALCulate<n>:MARKer<m>:FUNCTion:NOISe:RESult?.....	286

CALCulate<n>:MARKer<m>:FUNCTION:NOISe[:STATe]	287
CALCulate<n>:MARKer<m>:FUNCTION:OBAN:BANDwidth	240
CALCulate<n>:MARKer<m>:FUNCTION:OBAN:BANDwidth:PCT	240
CALCulate<n>:MARKer<m>:FUNCTION:OBW:BANDwidth	240
CALCulate<n>:MARKer<m>:FUNCTION:OBW:BANDwidth:PCT	240
CALCulate<n>:MARKer<m>:FUNCTION:POWer:PRESet	233
CALCulate<n>:MARKer<m>:FUNCTION:POWer:PRESet:CHECK?	234
CALCulate<n>:MARKer<m>:FUNCTION:POWer:RESult:PHZ	238
CALCulate<n>:MARKer<m>:FUNCTION:POWer:RESult?	234
CALCulate<n>:MARKer<m>:FUNCTION:POWer:SELEct	235
CALCulate<n>:MARKer<m>:FUNCTION:POWer[:STATe]	236
CALCulate<n>:MARKer<m>:FUNCTION:REFerence	276
CALCulate<n>:MARKer<m>:FUNCTION:STRack[:STATe]	277
CALCulate<n>:MARKer<m>:FUNCTION:TDMA:BURSt	241
CALCulate<n>:MARKer<m>:FUNCTION:TOI:RESult?	238
CALCulate<n>:MARKer<m>:FUNCTION:TOI:SEARChsignal	239
CALCulate<n>:MARKer<m>:MAXimum:NEXt	277
CALCulate<n>:MARKer<m>:MAXimum[:PEAK]	277
CALCulate<n>:MARKer<m>:MINimum[:PEAK]	278
CALCulate<n>:MARKer<m>:MODE	338
CALCulate<n>:MARKer<m>:X	279
CALCulate<n>:MARKer<m>:X:SLIMits<slim>:LEFT	279
CALCulate<n>:MARKer<m>:X:SLIMits<slim>:RIGHT	280
CALCulate<n>:MARKer<m>:X:SLIMits<slim>[:STATe]	280
CALCulate<n>:MARKer<m>:Y?	281
CALCulate<n>:MARKer<m>:Y?	339
CALCulate<n>:MARKer<m>[:STATe]	278
CALCulate<n>:MARKer<n>:FUNCTION:TOI[:STATe]	239
CALCulate<n>:MATH<t>:COPY:MEMory	266
CALCulate<n>:MATH<t>:STATe	267
CALCulate<n>:MATH<t>[:EXPRession][:DEFine]	266
CALCulate<n>:TRANSform:DTFault:PEAK:COUNT?	326
CALCulate<n>:TRANSform:DTFault:PEAK:DATA<peak>?	327
CALCulate<n>:TRANSform:DTFault:PEAK:THReshold	328
CALCulate<n>:TRANSform:DTFault:PEAK[:STATe]	327
CALibration<n>:ABORt	228
CALibration<n>:CONTInue?	229
CALibration<n>:MODE?	229
CALibration<n>:STARt?	230
CALibration<n>:STATus?	231
DIAGnostic[:SERVice]:IDENtification:MATerial?	209
DIAGnostic[:SERVice]:IDENtification:SERial?	209
DISPlay:BARGraph:PHOLd:RESet	296
DISPlay:BRIGhtness	215
DISPlay:DATE:FORMat	210
DISPlay[:WINDow]:TRACe:STYLe	301
DISPlay<n>:IMPedance:REFerence:POSition	340
DISPlay<n>:LOSS:REFerence	329
DISPlay<n>:LOSS:REFerence:POSition	329
DISPlay<n>:LOSS:Y:SCALe	329

DISPlay<n>:MAGNitude:REFerence.....	330
DISPlay<n>:MAGNitude:REFerence:POSition.....	330
DISPlay<n>:MAGNitude:Y:SCALe.....	331
DISPlay<n>:MAGNitude:Y:SPACing.....	331
DISPlay<n>:PHASe:REFerence.....	332
DISPlay<n>:PHASe:REFerence:POSition.....	332
DISPlay<n>:PHASe:UNWRap.....	333
DISPlay<n>:PHASe:Y:SCALe.....	333
DISPlay<n>:VSWR:Y:SCALe.....	334
DISPlay<n>:VSWR:Y:SCALe:MAXimum.....	334
DISPlay<n>:VSWR:Y:SCALe:MINimum.....	335
DISPlay<n>[:WINDow]:FETCh?.....	217
DISPlay<n>[:WINDow]:TRACe<t>:MEMory[:STATe].....	267
DISPlay<n>[:WINDow]:TRACe<t>:MODE.....	267
DISPlay<n>[:WINDow]:TRACe<t>:Y:SPACing.....	252
DISPlay<n>[:WINDow]:TRACe<t>:Y[:SCALe].....	252
DISPlay<n>[:WINDow]:TRACe<t>:Y[:SCALe]:ADJust.....	253
DISPlay<n>[:WINDow]:TRACe<t>:Y[:SCALe]:PDIVision.....	309
DISPlay<n>[:WINDow]:TRACe<t>:Y[:SCALe]:PDIVision.....	321
DISPlay<n>[:WINDow]:TRACe<t>:Y[:SCALe]:RLEVel.....	253
DISPlay<n>[:WINDow]:TRACe<t>:Y[:SCALe]:RLEVel:OFFSet.....	254
DISPlay<n>[:WINDow]:TRACe<t>:Y[:SCALe]:RPOSITION.....	254
DISPlay<n>[:WINDow]:TRACe<t>:Y[:SCALe]:RPOSITION.....	321
DISPlay<n>[:WINDow]:TRACe<t>[:STATe].....	268
FORMat:SREGister.....	351
FORMat[:DATA].....	269
HCOPY:DEVice:LANGUage.....	217
HCOPY[:IMMEDIATE].....	218
INITiate:CONTInuous.....	262
INITiate[:IMMEDIATE].....	263
INPut:ATTenuation.....	255
INPut:ATTenuation:AUTO.....	255
INPut:ATTenuation:MODE.....	256
INPut:GAIN:STATe.....	256
INPut:IMPedance.....	256
INPut:IMPedance:PAD.....	257
INSTrument[:SElect].....	231
MEASurement<n>:FORMat.....	324
MEASurement<n>:MODE.....	324
MMEMory:CATalog:DIRectories?.....	218
MMEMory:CATalog?.....	218
MMEMory:CDIRectory.....	219
MMEMory:CoPY.....	219
MMEMory:DATA.....	219
MMEMory:DELeTe.....	220
MMEMory:FILE.....	221
MMEMory:FILE:DATE.....	221
MMEMory:FILE:TIME.....	222
MMEMory:LOAD:STATe.....	222
MMEMory:MDIRectory.....	223

MMEMory:MOVE.....	223
MMEMory:NAME.....	224
MMEMory:RDIRECTory.....	224
MMEMory:STORE:STATe.....	224
SOURce:TG:AUTO.....	226
SOURce:TG:FREQuency.....	226
SOURce:TG:FREQuency:AUTO.....	227
SOURce:TG:POWer.....	227
SOURce:TG[:STATe].....	228
STATus:OPERation:ENABle.....	352
STATus:OPERation:NTRansition.....	352
STATus:OPERation:PTRansition.....	353
STATus:OPERation[:EVENT]?	352
STATus:PRESet.....	351
STATus:QUEStionable:CONDition?	353
STATus:QUEStionable:ENABle.....	353
STATus:QUEStionable:FREQuency:CONDition?	353
STATus:QUEStionable:FREQuency:ENABle.....	353
STATus:QUEStionable:FREQuency:NTRansition.....	354
STATus:QUEStionable:FREQuency:PTRansition.....	354
STATus:QUEStionable:FREQuency[:EVENT]?	353
STATus:QUEStionable:LIMit:CONDition?	353
STATus:QUEStionable:LIMit:ENABle.....	353
STATus:QUEStionable:LIMit:NTRansition.....	354
STATus:QUEStionable:LIMit:PTRansition.....	354
STATus:QUEStionable:LIMit[:EVENT]?	353
STATus:QUEStionable:NTRansition.....	354
STATus:QUEStionable:POWer:CONDition?	353
STATus:QUEStionable:POWer:ENABle.....	353
STATus:QUEStionable:POWer:NTRansition.....	354
STATus:QUEStionable:POWer:PTRansition.....	354
STATus:QUEStionable:POWer[:EVENT]?	353
STATus:QUEStionable:PTRansition.....	354
STATus:QUEStionable[:EVENT]?	353
STATus:QUEue[:NEXT]?	352
SYSTem:AUDio:VOLume.....	287
SYSTem:BEEPer:KEY:VOLume.....	216
SYSTem:BEEPer:POVerload[:STATe].....	216
SYSTem:BEEPer:VOLume.....	216
SYSTem:BNC:MODE.....	210
SYSTem:COMMunicate:LAN:ETHernet?	207
SYSTem:COMMunicate:LAN:GATeway.....	207
SYSTem:COMMunicate:LAN:SUBMask.....	208
SYSTem:COMMunicate:SOCKet:ADDReSS.....	208
SYSTem:COMMunicate:SOCKet:DHCP[:STATe].....	208
SYSTem:DATE.....	210
SYSTem:DISPlay:UPDate[:STATe].....	215
SYSTem:ERRor:ALL?	211
SYSTem:ERRor:CODE:ALL?	211
SYSTem:ERRor:CODE[:NEXT]?	211

SYSTem:ERRor:COUNT?	212
SYSTem:ERRor[:NEXT]?	212
SYSTem:HELP:HEADers?	212
SYSTem:HELP:SYNTax?	212
SYSTem:LANGuage	213
SYSTem:LANGuage:CATalog?	213
SYSTem:MEMory:FREE?	213
SYSTem:MEMory:TOTal?	213
SYSTem:MEMory:USED?	213
SYSTem:PRESet	206
SYSTem:PRESet:CALibration:DISCard	231
SYSTem:PRESet:FACTory	206
SYSTem:PRESet:MODE	206
SYSTem:PRESet:USER	207
SYSTem:SET:DISPlay?	225
SYSTem:SET:LOCK	225
SYSTem:SET:UNLock	225
SYSTem:SET?	225
SYSTem:STORe:FREE?	213
SYSTem:STORe:TOTal?	213
SYSTem:STORe:USED?	213
SYSTem:TIME	214
SYSTem:TZONee	214
TRACe[:DATA]?	296
TRACe[:DATA]?	301
TRACe[:DATA]?	308
TRACe[:DATA]?	318
TRACe[:DATA]?	337
TRACe<n>[:DATA]?	270
TRIGger[:SEQuence]:HOLDoff[:TIME]	264
TRIGger[:SEQuence]:LEVel:IQPower	322
TRIGger[:SEQuence]:LEVel:VIDeo	264
TRIGger[:SEQuence]:SLOPe	264
TRIGger[:SEQuence]:SOURce	265
TRIGger[:SEQuence]:SOURce	322
UNIT<n>:LENGth	214
UNIT<n>:POWer	258

Index

Symbols

*OPC	201
*OPC?	201
*WAI	201
1-port cable loss	172
9.91E37 Remote control	200

A

Alpha factor	164
AM demodulation	128
AM modulation depth	79
Amplitude configuration	98, 150, 167
Analog demodulation	147, 158
Application cards	8
Application notes	8
ASK	158
Attenuation	101
Audio	43
Audio lowpass filter	152
Automatic system boot	44

B

Backlight	43
Bandwidth	182
Demodulation	151
Resolution	107
Resolution (CISPR)	143
Video	108
Beeper volume	43
Block data	197
BNC connector	39
Boolean parameters	196
Brackets	197
Brightness (display)	43
Brochure	7
BT factor	164
Burst length	77

C

Cable loss	172
Cable model	177
Case-sensitivity SCPI	193
Center frequency	94, 98
Channel bandwidth Channel power	71
OBW	82
Channel power	70
Channel power density	72
Channel scan	140
Channel selection	98
Channel table Receiver	139, 140
Spectrum analyzer	97
CISPR (detector)	145
CISPR bandwidth	143
Clear status Remote	203
Colon	197

Color scheme	43
Colors (spectrogram)	87
Comma	197
Command sequence Remote	205
Commands Brackets	197
Colon	197
Comma	197
Command line structure	199
Double dagger	197
Overlapping	200
Question mark	197
Quotation mark	197
Sequential	200
Syntax elements	197
Vertical stroke	197
White space	197
Common commands Syntax	193
Continuous measurement Analog demodulation	156
Digital demodulation	168
Receiver	144
Spectrum analyzer	110
VNA	183
Custom cable model	178

D

Data sheet	7
Dataset	46
Date	41
Date format	42
DBW	151
Deemphasis filter	153
DEF	196
Default values Remote	204
Delta marker	119
Demodulation Digital	158
Demodulation bandwidth	151
Demodulation filter	164
Demodulation time	128
Density (channel power)	72
Detector (CISPR)	145
DHCP	39
Digital modulation	158
Disk space	47
Display	43
Display range	104
Distance-to-Fault	173
Documents	7
Double dagger	197
DOWN	196
Downlink	97
DTF	173

E

Electrostatic discharge	10
ESD	10

- Event status enable register (ESE)
 Remote 203
- Event status register (ESR)
 Remote 203
- Eye diagram 160
- ## F
- File manager 47
- Firmware options 34
- Firmware update 32
- Flash memory 47
- FM broadcast 153
- FM demodulation 128
- Format 175
- Frequency 93, 94, 139, 150, 166, 179
- Frequency counter 126
- Frequency deviation 153
- Frequency mode 97
- Frequency offset 95
- Frequency span 96
- Frequency step size 94, 139
- FSK 158
- Full span 96
- ## G
- Gateway 39
- Getting started 7
- ## H
- Harmonic distortion 78
- ## I
- Identification
 Remote 203
- IF filter 107
- Impedance 98
- INF 196
- Input impedance 98
- InstrumentView 25
- Intermodulation 74
- Invalid results
 Remote control 200
- IP address 39
- IP3 74
- IST flag
 Remote 204
- ## K
- Key click volume 43
- Keywords
 see Mnemonics 192
- ## L
- LAN 39
- Language 42
- Last span 96
- Level range (spectrogram) 87
- Limit line 130, 145
- Limits 156
- Lines 130, 145
- ## M
- Manual step size 94, 139
- Marker 119
- Marker demodulation 128
- Marker display mode 146
- Marker function
 Demodulation 128
 Frequency counter 126
 n dB down 127
 Noise measurement 126
- Marker list 119
- Marker position 120, 123
- Marker search 124
- Marker tracking 124
- Marker type 122
- Matching pads 98
- MAX 196
- Max hold 138
- Measurement
 AM modulation depth 79
 Bargraph 134
 Channel power 70
 Frequency scan 136
 Harmonic distortion 78
 OBW 81
 TDMA power 75
 Third order intermodulation 74
- Measurement bandwidth 182
- Measurement frequency 94, 139
- Measurement mode
 Analog demodulation 156
 Digital demodulation 168
 Receiver 144
 Spectrum analyzer 110
 VNA 183
- Measurement sensitivity 101, 103
- Measurement time 110, 144
 TDMA power 77
- Memory stick 47
- MIN 196
- Mnemonics 192
 Optional 194
- MobileView 26
- Modulation depth 79, 161
- Modulation deviation 161
- Modulation error 162
- Modulation index 161
- ## N
- n dB down 127
- NAN 196
- NAN (not a number)
 Remote control 200
- Network configuration 39
- NINF 196
- Noise measurement 126
- Numeric parameters 195
- Numeric values
 Special 196
- ## O
- OBW 81
- Occupied bandwidth 81

- Offset
 - Frequency 95
 - Reference level 100
- Operation
 - InstrumentView 25
 - MobileView 26
 - SCPI 27
- Operation complete
 - Remote 204
- Optional applications 34
- Options
 - Identification (remote) 204
- Overlapping commands 200
 - Preventing 201
- P**
- Parameters
 - Block data 197
 - Boolean 196
 - Numeric values 195
 - SCPI 195
 - Special numeric values 196
 - String 197
 - Text 197
- Playback (spectrogram) 90
- Power overload 43
- Power unit 72
- Preamplifier 103
- Preset 37
- Q**
- Queries 199
- Question mark 197, 199
- Quotation mark 197
- R**
- Rack 12
- RBW 107
- Receiver 134
- Receiver frequency 139
- Receiver frequency (scan) 140
- Reference input 39
- Reference level 99
 - Channel power 73
 - OBW 83
 - TDMA power 77
- Reference level (spectrogram) 87
- Reference level position 100, 167
- Reference offset 100
- Reflection 171
- Release notes 8
- Remote control 27
- Reset values
 - Remote 204
- Resolution bandwidth 107, 110
- Resolution bandwidth (CISPR) 143
- Resolution filter 107
- RF attenuation 101
- Roll-off factor 164
- S**
- S11 171
- S21 171
- Safety instructions 7
- Scan range 140
- SCPI
 - Parameters 195
 - Syntax 193
- SCPI remote control 27
- Search range 124
- Self-test
 - Remote 205
- Sensitivity 101
- Sequential commands 200
- Service manual 7
- Service request enable register (SRE)
 - Remote 204
- Signal bandwidth measurement 127
- Signal source 52
- Single measurement
 - Analog demodulation 156
 - Digital demodulation 168
 - Receiver 144
 - Spectrum analyzer 110
 - VNA 183
- Span 96, 110
- Spectrogram colors 87
- Spectrogram playback 90
- Standard
 - Channel power 72
 - OBW 76, 83
- Start frequency 97, 140
- Status byte
 - Remote 203, 205
- Step size 94, 139
- Stop frequency 97, 140
- Storage 47
- String in remote commands 197
- Subnet mask 39
- Suffixes 194
- Sweep mode 110
- Sweep time 110
- Symbol rate 165
- Symbols 160, 165
- Syntax elements
 - SCPI 197
- System date 41
- System time 41
- T**
- TDMA power 75
- Template 46
- Text paramters in remote commands 197
- THD 78
- Third order intermodulation 74
- Threshold line 130, 145
- Time 41
- Time zone 41
- TOI 74
- Tracking generator 52
- Tracking markers 124
- Transmission 171
- Trigger
 - Event (remote) 205
- Trigger input 39
- Tune to marker frequency 146

U

Unit	103
UP	196
Update firmware	32
Uplink	97
User manual	7

V

VBW	108
Vector network analysis	170
Vertical stroke	197
Video bandwidth	108
Video filter	108
VNA	170
VNA formats	175
Volume	43
Volume (marker demodulation)	128

W

Wait	
Remote	205
White papers	8
White space	197
Wi-Fi	39
WLAN	39

Y

Y-axis scale	104
--------------------	-----

Z

Zero span	96
-----------------	----