

R&S® FPL1000

Spectrum Analyzer

User Manual



This manual applies to the following R&S®FPL1000 models with firmware version 1.30 and higher:

- R&S®FPL1003 (1304.0004K03) - FPL1000 with maximum frequency 3 GHz
- R&S®FPL1007 (1304.0004K07) - FPL1000 with maximum frequency 7.5 GHz

In addition to the base unit, the following options are described:

- R&S FPL1-B4, OCXO (1323.1902.02)
- R&S FPL1-B5, Additional Interfaces (1323.1883.02)
- R&S FPL1-B10, GPIB interface (1323.1890.02)
- R&S FPL1-B22, preamplifier (1323.1719.02)
- R&S FPL1-B25, electronic attenuator (1323.1990.02)
- R&S FPL1-B30, DC power supply (1323.1877.02)
- R&S FPL1-B31, Li-Ion battery pack and charger (1323.1725.02)
- R&S FPL1-K9, Power sensor support (1323.1754.02)
- R&S FPL1-K54, EMI measurements (1323.1783.02)

© 2019 Rohde & Schwarz GmbH & Co. KG

Mühlhofstr. 15, 81671 München, Germany

Phone: +49 89 41 29 - 0

Fax: +49 89 41 29 12 164

Email: info@rohde-schwarz.com

Internet: www.rohde-schwarz.com

Subject to change – Data without tolerance limits is not binding.

R&S® is a registered trademark of Rohde & Schwarz GmbH & Co. KG.

Trade names are trademarks of the owners.

1178.3370.02 | Version 06 | R&S®FPL1000

Throughout this manual, products from Rohde & Schwarz are indicated without the ® symbol, e.g. R&S®FPL1000 is indicated as R&S FPL1000.

Contents

1	Preface	7
1.1	Conventions Used in the Documentation.....	7
2	Safety Information	9
3	Documentation Overview	10
3.1	Getting Started Manual.....	10
3.2	User Manuals and Help.....	10
3.3	Service Manual.....	10
3.4	Instrument Security Procedures.....	11
3.5	Basic Safety Instructions.....	11
3.6	Data Sheets and Brochures.....	11
3.7	Release Notes and Open Source Acknowledgment (OSA).....	11
3.8	Application Notes, Application Cards, White Papers, etc.....	11
3.9	Calibration Certificate.....	12
4	Welcome to the R&S FPL1000	13
5	Getting Started	14
5.1	Preparing for Use.....	14
5.2	Instrument Tour.....	36
5.3	Trying Out the Instrument.....	48
5.4	Operating the Instrument.....	66
6	Applications, Measurement Channels, and Result Displays	85
6.1	Available Applications.....	85
6.2	R&S MultiView.....	86
6.3	Defining Channel Setups.....	87
6.4	Running a Sequence of Measurements.....	89
6.5	Channel Setup Overview.....	93
6.6	Configuring Result Displays.....	94
7	Common Instrument Functions	100
7.1	Toolbar Functions.....	100
7.2	Data Management.....	101

7.3	General Instrument Setup.....	130
7.4	Network and Remote Operation.....	167
8	The Spectrum Application (RF Measurements).....	237
8.1	Configuration Overview.....	237
8.2	Measurements and Results.....	239
8.3	Receiving Data Input and Providing Data Output.....	409
8.4	Frequency and Span Configuration.....	418
8.5	Amplitude and Vertical Axis Configuration.....	426
8.6	Bandwidth, Filter and Sweep Configuration.....	434
8.7	Trigger and Gate Configuration.....	449
8.8	Adjusting Settings Automatically.....	461
8.9	Marker Usage.....	463
8.10	Trace Configuration.....	503
8.11	Display and Limit Lines.....	535
8.12	Zoomed Displays.....	554
8.13	Importing and Exporting Measurement Results for Evaluation.....	560
8.14	Optimizing Measurements.....	571
9	Remote Commands.....	573
9.1	Conventions Used in SCPI Command Descriptions.....	573
9.2	Common Suffixes.....	574
9.3	Common Commands.....	574
9.4	Commands for Remote Instrument Operation.....	578
9.5	Selecting the Operating Mode and Application.....	579
9.6	Configuring and Performing Measurements.....	587
9.7	Remote Commands for Result Displays.....	702
9.8	Setting Basic Spectrum RF Measurement Parameters.....	711
9.9	Managing Settings and Results.....	861
9.10	Configuring the R&S FPL1000.....	890
9.11	Emulating Other Instruments' Commands.....	914
9.12	Using the Status Register.....	947
9.13	Deprecated Commands.....	959
10	Maintenance.....	961

10.1	Cleaning.....	961
11	Troubleshooting.....	963
11.1	Error Information.....	963
11.2	Error Messages in Remote Control Mode.....	964
11.3	Troubleshooting Remote Operation.....	965
11.4	Miscellaneous Troubleshooting Hints.....	966
11.5	Collecting Information for Support.....	968
	List of Commands (Spectrum mode).....	970
	Index.....	987

1 Preface

This chapter provides safety-related information, an overview of the user documentation and the conventions used in the documentation.

1.1 Conventions Used in the Documentation

1.1.1 Typographical Conventions

The following text markers are used throughout this documentation:

Convention	Description
"Graphical user interface elements"	All names of graphical user interface elements on the screen, such as dialog boxes, menus, options, buttons, and softkeys are enclosed by quotation marks.
[Keys]	Key and knob names are enclosed by square brackets.
Filenames, commands, program code	Filenames, commands, coding samples and screen output are distinguished by their font.
<i>Input</i>	Input to be entered by the user is displayed in italics.
Links	Links that you can click are displayed in blue font.
"References"	References to other parts of the documentation are enclosed by quotation marks.

1.1.2 Conventions for Procedure Descriptions

When operating the instrument, several alternative methods may be available to perform the same task. In this case, the procedure using the touchscreen is described. Any elements that can be activated by touching can also be clicked using an additionally connected mouse. The alternative procedure using the keys on the instrument or the on-screen keyboard is only described if it deviates from the standard operating procedures.

The term "select" may refer to any of the described methods, i.e. using a finger on the touchscreen, a mouse pointer in the display, or a key on the instrument or on a keyboard.

1.1.3 Notes on Screenshots

When describing the functions of the product, we use sample screenshots. These screenshots are meant to illustrate as many as possible of the provided functions and

possible interdependencies between parameters. The shown values may not represent realistic usage scenarios.

The screenshots usually show a fully equipped product, that is: with all options installed. Thus, some functions shown in the screenshots may not be available in your particular product configuration.

2 Safety Information

The product documentation helps you to use the R&S FPL1000 safely and efficiently. Follow the instructions provided here and in the printed "Basic Safety Instructions". Keep the product documentation nearby and offer it to other users.

Intended use

The R&S FPL1000 is designated for the development, production and verification of electronic components and devices in industrial, administrative, and laboratory environments. Use the R&S FPL1000 only for its designated purpose. Observe the operating conditions and performance limits stated in the data sheet.

Where do I find safety information?

Safety information is part of the product documentation. It warns you about the potential dangers and gives instructions how to prevent personal injuries or damage caused by dangerous situations. Safety information is provided as follows:

- The printed "Basic Safety Instructions" provide safety information in many languages and are delivered with the R&S FPL1000.
- Throughout the documentation, safety instructions are provided when you need to take care during setup or operation.

3 Documentation Overview

This section provides an overview of the R&S FPL1000 user documentation. Unless specified otherwise, you find the documents on the R&S FPL1000 product page at:

www.rohde-schwarz.com/manual/FPL1000

3.1 Getting Started Manual

Introduces the R&S FPL1000 and describes how to set up and start working with the product. Includes basic operations, typical measurement examples, and general information, e.g. safety instructions, etc.

A printed version is delivered with the instrument. A PDF version is available for download on the Internet.

3.2 User Manuals and Help

Separate user manuals are provided for the base unit and the firmware applications:

- Base unit manual
Contains the description of all instrument modes and functions. It also provides an introduction to remote control, a complete description of the remote control commands with programming examples, and information on maintenance, instrument interfaces and error messages. Includes the contents of the getting started manual.
- Firmware application manual
Contains the description of the specific functions of a firmware application, including remote control commands. Basic information on operating the R&S FPL1000 is not included.

The contents of the user manuals are available as help in the R&S FPL1000. The help offers quick, context-sensitive access to the complete information for the base unit and the firmware applications.

All user manuals are also available for download or for immediate display on the Internet.

3.3 Service Manual

Describes the performance test for checking the rated specifications, module replacement and repair, firmware update, troubleshooting and fault elimination, and contains mechanical drawings and spare part lists.

The service manual is available for registered users on the global Rohde & Schwarz information system (GLORIS):

<https://gloris.rohde-schwarz.com>

3.4 Instrument Security Procedures

Deals with security issues when working with the R&S FPL1000 in secure areas. It is available for download on the Internet.

3.5 Basic Safety Instructions

Contains safety instructions, operating conditions and further important information. The printed document is delivered with the instrument.

3.6 Data Sheets and Brochures

The data sheet contains the technical specifications of the R&S FPL1000. It also lists the firmware applications and their order numbers, and optional accessories.

The brochure provides an overview of the instrument and deals with the specific characteristics.

See www.rohde-schwarz.com/brochure-datasheet/FPL1000

3.7 Release Notes and Open Source Acknowledgment (OSA)

The release notes list new features, improvements and known issues of the current firmware version, and describe the firmware installation.

The open source acknowledgment document provides verbatim license texts of the used open source software.

See www.rohde-schwarz.com/firmware/FPL1000

3.8 Application Notes, Application Cards, White Papers, etc.

These documents deal with special applications or background information on particular topics.

See www.rohde-schwarz.com/application/FPL1000

3.9 Calibration Certificate

The document is available on <https://gloris.rohde-schwarz.com/calcert>. You need the device ID of your instrument, which you can find on a label on the rear panel.

4 Welcome to the R&S FPL1000

The R&S FPL1000 is a new Rohde & Schwarz signal and spectrum analyzer developed to meet demanding customer requirements. Offering low phase noise, wide analysis bandwidth and straightforward and intuitive operation, the analyzer makes measurements fast and easy.

This user manual contains a description of the functionality that the instrument provides, including remote control operation. The latest version is available for download at the product homepage (<http://www.rohde-schwarz.com/product/FPL1000>).

5 Getting Started

5.1 Preparing for Use

- [Putting into Operation](#)..... 14
- [Windows Operating System](#).....23
- [Connecting USB Devices](#).....27
- [Connecting an External Monitor](#).....28
- [Setting Up a Network \(LAN\) Connection](#).....30
- [Configuring the Initial Instrument Settings](#)..... 35

5.1.1 Putting into Operation

This section describes the basic steps to be taken when setting up the R&S FPL1000 for the first time.

⚠ WARNING

Risk of injury due to disregarding safety information

Observe the information on appropriate operating conditions provided in the data sheet to prevent personal injury or damage to the instrument. Read and observe the basic safety instructions provided with the instrument, in addition to the safety instructions in the following sections. In particular:

- Do not open the instrument casing.
-

NOTICE

Risk of instrument damage due to inappropriate operating conditions

Specific operating conditions are required to ensure accurate measurements and to avoid damage to the instrument. Observe the information on appropriate operating conditions provided in the basic safety instructions and the instrument's data sheet.

NOTICE

Instrument damage caused by electrostatic discharge

Electrostatic discharge (ESD) can damage the electronic components of the instrument and the device under test (DUT). Electrostatic discharge is most likely to occur when you connect or disconnect a DUT or test fixture to the instrument's test ports. To prevent electrostatic discharge, use a wrist strap and cord and connect yourself to the ground, or use a conductive floor mat and heel strap combination.

NOTICE**Risk of instrument damage due to inappropriate operating conditions**

An unsuitable operating site or test setup can damage the instrument and connected devices. Before switching on the instrument, observe the information on appropriate operating conditions provided in the data sheet. In particular, ensure the following:

- All fan openings are unobstructed and the airflow perforations are unimpeded. A minimum distance of 10 cm to other objects is recommended.
- The instrument is dry and shows no sign of condensation.
- The instrument is positioned as described in the following sections.
- The ambient temperature does not exceed the range specified in the data sheet.
- Signal levels at the input connectors are all within the specified ranges.
- Signal outputs are connected correctly and are not overloaded.

**EMI impact on measurement results**

Electromagnetic interference (EMI) may affect the measurement results.

To suppress generated electromagnetic interference (EMI):

- Use suitable shielded cables of high quality. For example, use double-shielded RF and LAN cables.
- Always terminate open cable ends.
- Note the EMC classification in the data sheet.

• Unpacking and Checking the Instrument	15
• Accessory List	16
• Placing or Mounting the Instrument	16
• Connecting the AC Power	18
• Changing the AC Supply Fuse	19
• Connecting an Optional DC Power Supply (R&S FPL1-B30)	19
• Connecting an Optional Battery Pack (R&S FPL1-B31)	20
• Switching the Instrument On and Off	21
• Performing a Self-Alignment	22
• Checking the Supplied Options	22

5.1.1.1 Unpacking and Checking the Instrument

Check the equipment for completeness using the delivery note and the accessory lists for the various items. Check the instrument for any damage. If there is damage, immediately contact the carrier who delivered the instrument. Make sure not to discard the box and packing material.

**Packing material**

Retain the original packing material. If the instrument needs to be transported or shipped later, you can use the material to protect the control elements and connectors.

NOTICE**Risk of instrument damage during transportation and shipment**

Insufficient protection against mechanical and electrostatic effects during transportation and shipment can damage the instrument.

- Always make sure that sufficient mechanical and electrostatic protection is provided.
- When shipping an instrument, use the original packaging. If it is not available, allow for sufficient padding to prevent the instrument from moving around inside the box. Pack the instrument in antistatic wrap to protect it from electrostatic charging.
- Secure the instrument to prevent any movement and other mechanical effects during transportation.

The **carrying handles** are designed to lift or carry the instrument. Do not apply excessive external force to the handles.

5.1.1.2 Accessory List

The instrument comes with the following accessories:

- Power cable
- Printed Getting Started manual

5.1.1.3 Placing or Mounting the Instrument

The R&S FPL1000 is designed for use either on a bench top or in a rack, or as a portable instrument (with optional battery operation) in a transport bag in the field.

Bench Top Operation

If the R&S FPL1000 is operated on a bench top, the surface should be flat. The instrument can be used in horizontal position, standing on its feet, or with the support feet on the bottom extended.

⚠ CAUTION**Risk of injury if feet are folded out**

The feet can fold in if they are not folded out completely or if the instrument is shifted. This can cause damage or injury.

- Fold the feet completely in or out to ensure stability of the instrument. Never shift the instrument when the feet are folded out.
- When the feet are folded out, do not work under the instrument or place anything underneath.
- The feet can break if they are overloaded. The overall load on the folded-out feet must not exceed 200 N.

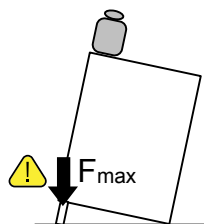
**⚠ CAUTION****Risk of injury when stacking instruments insecurely**

Never stack instruments on top of each other. The instrument's top surface area is too small to stack multiple instruments. Stacked instruments can tilt over and cause injury or damage the instrument.

If you need to stack instruments, install them in a rack.

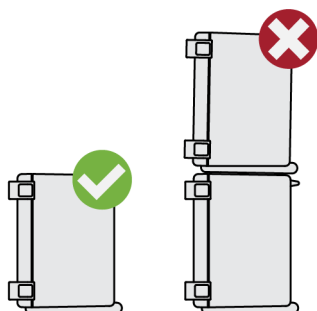
**Rackmounting**

The R&S FPL1000 can be installed in a rack using a rack adapter kit (order no. see data sheet). The installation instructions are part of the adapter kit.

NOTICE**Risk of instrument damage due to insufficient airflow in a rack**

If you mount several instruments in a rack, you need an efficient ventilation concept to ensure that the instruments do not overheat. Insufficient airflow for a longer period can disturb the operation and even cause damage.

Portable operation

An optional carrying bag designed specifically for the R&S FPL1000 allows you to protect the instrument while working in the field. The bag includes ventilation areas at the position of the ventilation outlets in the casing to ensure air circulation. The transparent cover allows you to operate the instrument without removing it from the bag. With the help of the optional vest holster you can carry the R&S FPL1000 in its bag and keep your hands free. Together with the optional battery pack (see [Chapter 5.1.1.7, "Connecting an Optional Battery Pack \(R&S FPL1-B31\)"](#), on page 20), and packed in the dedicated carrying bag, the R&S FPL1000 is ideally suited for operation directly in the field, even in rough environments.



For details on optional accessories see the R&S FPL1000 data sheet.

5.1.1.4 Connecting the AC Power

The R&S FPL1000 is equipped with an AC power supply connector. The R&S FPL1000 can be used with different AC power voltages and adapts itself automatically to it. Refer to the datasheet for the requirements of voltage and frequency. The AC power connector is located on the rear panel of the instrument.

For details on the connector, refer to [Chapter 5.2.2.2, "AC Power Supply Connection and Main Power Switch"](#), on page 44.



- ▶ Connect the R&S FPL1000 to the AC power supply using the supplied power cable.
Since the instrument is assembled in line with the specifications for safety class EN61010, it must only be connected to an outlet that has a ground contact.

5.1.1.5 Changing the AC Supply Fuse

If the battery option R&S FPL1-B31 is installed, an AC supply fuse is built into the AC power supply connector. Only use fuses of the type 5A T IEC60127-2/V (order no. 0099.6735.00). Such fuses are used for all of the specified nominal AC supply voltages.

To change the AC supply fuses

1. Disconnect the power cable.
2. Open the flap covering the fuse holder using a small screwdriver (or similar).
3. Remove the fuse holder.
4. Remove the fuse and install the new one.
5. Reinsert the fuse holder.
6. Close the flap.

5.1.1.6 Connecting an Optional DC Power Supply (R&S FPL1-B30)

The R&S FPL1000 can also be equipped with an optional (internal) DC power supply (R&S FPL1-B30). If installed, the R&S FPL1000 can be operated by a DC voltage of 10.4 V to 28 V.

⚠ WARNING

Risk of electric shock

Insufficient insulation and exceeding the current limitation of external power supplies for safety extra-low DC voltage (SELV) can lead to electric shock.

Be sure to meet the requirements for reinforced/double insulation in accordance with DIN/EN/IEC 61010 (UL 3111, CSA C22.2 No. 1010.1) or DIN/EN/IEC 60950 (UL 1950, CSA C22.2 No. 950). Provide current limitation in accordance with DIN EN 61010-1 Appendix F2.1.



DC Connection

- ▶ Connect the DC power supply on the rear panel of the R&S FPL1000 to the power source using the supplied power cable.

5.1.1.7 Connecting an Optional Battery Pack (R&S FPL1-B31)

As an alternative to the fixed AC or DC power supply, the R&S FPL1000 can be operated by a battery pack if the option R&S FPL1-B31 is installed. If the battery pack is installed and neither DC nor AC power is supplied, the R&S FPL1000 automatically switches to battery operation (during operation).

The R&S FPL1000 comes with the battery pack already installed if the battery option was ordered together with the instrument. Otherwise, insert the battery packs in the slots at the top of the rear panel.

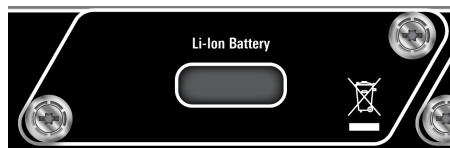

The battery pack is charged directly in the R&S FPL1000 via the common AC or DC power supply. The battery pack can be charged at an ambient temperature between +0 °C and +45 °C. If the temperature is above or below these values, charging is interrupted. If the battery temperature rises above +53 °C, charging is stopped.

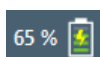

When the battery is being charged in standby mode, the [Power] LED blinks. During operation, the status bar indicates that the battery is being charged.

Remote command to determine the battery charge state:

[DIAGnostic:SERvice:BATTery:LEVel?](#) on page 908



The battery pack is not charged in the factory. The battery pack must be charged before it is used the first time. A new battery pack or a battery pack which has not been used for a longer time attains full capacity after several charge/ discharge cycles.

Charging should be performed at a constant ambient temperature as temperature variations may cause the charger to be switched off too early.

Additional battery packs (R&S FPL1-Z4)

In addition to the internal battery pack option (R&S FPL1-B30), spare battery packs are available for the R&S FPL1000 (R&S FPL1-Z4). You can exchange the batteries while

the R&S FPL1000 is running, as long as one battery remains in the instrument. However, it is not recommended that you operate the R&S FPL1000 with only one battery for a longer period. Additional battery packs can also be charged using the external battery charger option R&S FSV-B34.

5.1.1.8 Switching the Instrument On and Off

Switching on the instrument

1. Press the AC power switch on the rear panel to position "I".
2. Press the [Power] key on the front panel of the instrument.

The instrument operates on DC or AC power, whichever is supplied. After booting, the instrument is ready for operation. The green [POWER] LED indicates this. A steady orange LED indicates the instrument is in standby mode.



Warm-up time for OCXO (option R&S FPL1-B4)

When the instrument is switched on, the OCXO requires an extended warm-up time (see data sheet).

Switching off the instrument

1. Press the [Power] key on the front panel.
The R&S FPL1000 switches to standby mode (not in battery operation).
2. For AC power operation, set the AC power switch on the rear panel to position "O".
For DC power operation, disconnect the DC power supply cable.
The R&S FPL1000 changes into off mode.

NOTICE

Risk of losing data

If you switch off the running instrument using the rear panel switch or by disconnecting the power cord, and no (charged) battery is available, the instrument loses its current settings. Furthermore, program data may be lost.

Press the Power key first to shut down the application properly.

5.1.1.9 Performing a Self-Alignment



During instrument start, the installed hardware is checked against the current firmware version to ensure the hardware is supported. If not, an error message is displayed ("Wrong Firmware Version") and you are asked to update the firmware. Until the firmware version is updated, self-alignment fails.

(For details refer to the R&S FPL1000 User Manual).

When strong temperature changes occur, you may have to perform a self-alignment to align the data to a reference source.



Operating temperature

Before performing this functional test, make sure that the instrument has reached its operating temperature (for details, refer to the data sheet).

A message in the status bar ("Instrument warming up...") indicates that the operating temperature has not yet been reached.

Depending on the installation settings, an automatic self-alignment is performed each time the instrument is switched on, and a dialog is displayed indicating how much warm-up time is still required before self-alignment can be performed.

Performing a self-alignment

1. Press the [SETUP] key.
2. Press the "Alignment" softkey.
3. Select the "Start Self Alignment" button in the "Alignment" dialog box.

Once the system correction values have been calculated successfully, a message is displayed.



To display the alignment results again later

- Press the [SETUP] key.
- Press the "Alignment" softkey.

5.1.1.10 Checking the Supplied Options

The instrument may be equipped with both hardware and firmware options. To check whether the installed options correspond to the options indicated on the delivery note, proceed as follows.

1. Press the [SETUP] key.
2. Press the "System Config" softkey.
3. Switch to the "Versions + Options" tab in the "System Configuration" dialog.

A list with hardware and firmware information is displayed.

4. Check the availability of the hardware options as indicated in the delivery note.

5.1.2 Windows Operating System

The instrument contains the Windows operating system which has been configured according to the instrument's features and needs. Changes in the system setup are only required when peripherals like keyboard or a printer are installed or if the network configuration does not comply with the default settings. After the R&S FPL1000 is started, the operating system boots and the instrument firmware is started automatically.

To ensure that the instrument software functions properly, certain rules must be adhered to concerning the operating system.

NOTICE

Risk of rendering instrument unusable

The instrument is equipped with the Windows operating system. You can install additional software on the instrument, however, additional software can impair instrument function. Thus, run only programs that Rohde & Schwarz has tested for compatibility with the instrument software.

The drivers and programs used on the instrument under Windows are adapted to the instrument. Only install update software released by Rohde & Schwarz to modify existing instrument software.

The following program packages have been tested:

- Symantec Endpoint Security – virus-protection software
- FileShredder - for reliable deletion of files on the hard disk

5.1.2.1 Virus Protection

Take appropriate steps to protect your instruments from infection. Use strong firewall settings and scan any removable storage device used with a Rohde & Schwarz instrument regularly. It is also recommended that you install anti-virus software on the instrument. Rohde & Schwarz does NOT recommend running anti-virus software in the background ("on-access" mode) on Windows-based instruments, due to potentially degrading instrument performance. However, Rohde & Schwarz does recommend running it during non-critical hours.

For details and recommendations, see the following Rohde & Schwarz white paper:

- [1EF96: Malware Protection Windows 10](#)

5.1.2.2 Service Packs and Updates

Microsoft regularly creates security updates and other patches to protect Windows-based operating systems. These are released through the Microsoft Update website

and associated update server. Instruments using Windows, especially those that connect to a network, should be updated regularly.

For details and recommendations, see the following Rohde & Schwarz white paper:

- [1EF96: Malware Protection Windows 10](#)

5.1.2.3 Login

Windows requires that users identify themselves by entering a user name and password in a login window. By default, the R&S FPL1000 provides two user accounts:

- **"Instrument"**: a standard user account with limited access
- **"Administrator"**: an administrator account with unrestricted access to the computer/domain

Some administrative tasks require administrator rights (e.g. the configuration of a LAN network). Refer to the description of the basic instrument setup ([SETUP] menu) to find out which functions are affected.

Automatic login

For the standard instrument account, an automatic login function is active by default. If activated, login is carried out automatically in the background when the R&S FPL1000 is started, without having to enter a password. This function is active until an administrator explicitly deactivates it or changes the password.

For information on how to deactivate or reactivate the automatic login, refer to ["Automatic Login Function"](#) on page 24.

Passwords

For all default user accounts, the initial password is *894129*. Note that this password is very weak, and it is recommended that you change the password for both users after initial login. An administrator can change the password in Windows for any user at any time via "Start > Settings > Account > SignIn Options > Password > Change".



Changing the password and use of auto-login function

Note that when you change the default passwords, the default auto-login function no longer works! Reactivate it manually as described in ["Reactivating the automatic login function"](#) on page 26.

Automatic Login Function

When shipped, the instrument automatically logs on the default "Instrument" user to Windows using the default password.

Switching users when using the automatic login function

Which user account is used is defined during login. If automatic login is active, the login window is not displayed. However, you can also switch the user account to be used when the automatic login function is active.



1. Select the "Windows" icon in the toolbar to access the operating system of the R&S FPL1000 (see also [Chapter 5.1.2.4, "Accessing the Start Menu"](#), on page 26).

2. Press [CTRL + ALT + DEL], then select "Sign out".

The "Login" dialog box is displayed, in which you can enter the different user account name and password.

Deactivating the automatic login function

To deactivate the automatic login function, perform the following steps:

1. Log in to the R&S FPL1000 operating system using an administrator account (see ["Switching users when using the automatic login function"](#) on page 25).



2. Select the "Windows" icon in the toolbar to access the operating system of the R&S FPL1000 (see also [Chapter 5.1.2.4, "Accessing the Start Menu"](#), on page 26).

3. In the "Start" menu, select "Run".

The "Run" dialog box is displayed.

4. Enter the command

```
C:\Users\Public\Documents\Rohde-Schwarz\Analyzer\user\  
NO_AUTOLOGIN.REG.
```

5. Press the [ENTER] key to confirm.

This command deactivates the automatic login function. The next time you switch on the instrument, the operating system prompts you to enter your user name and password before it starts the firmware.

Adapting the automatic login function to a new password

If you change the "Instrument" user's password, which is used during automatic login, this function no longer works. Adapt the settings for the command that activates the auto login function first.

1. Open the

```
C:\Users\Public\Documents\Rohde-Schwarz\Analyzer\user\  
NO_AUTOLOGIN.REG file in any text editor (e.g. Notepad).
```

2. In the line "DefaultPassword"="894129", replace the default password (894129) by the new password for automatic login.

3. Save the changes to the file.

Reactivating the automatic login function

1. Log in to the R&S FPL1000 operating system using an administrator account (see ["Switching users when using the automatic login function"](#) on page 25).
2.  Select the "Windows" icon in the toolbar to access the operating system of the R&S FPL1000 (see also [Chapter 5.1.2.4, "Accessing the Start Menu"](#), on page 26).
3. In the "Start" menu, select "Run".
The "Run" dialog box is displayed.
4. Enter the command
`C:\Users\Public\Documents\Rohde-Schwarz\Analyzer\user\AUTOLOGIN.REG.`
5. Press the [ENTER] key to confirm.
This command reactivates automatic login function. It is active the next time the instrument reboots.

5.1.2.4 Accessing the Start Menu

The Windows "Start" menu provides access to the Windows functionality and installed programs.

To open the "Start" menu:



- ▶ Select the "Windows" icon in the toolbar, or press the "Windows" key or the [CTRL + ESC] key combination on the (external) keyboard.

All necessary system settings can be defined in the "Start > Settings" menu.

(For required settings refer to the Windows documentation and to the hardware description).

5.1.2.5 Accessing the Windows Taskbar

The Windows taskbar also provides quick access to commonly used programs, for example Paint or WordPad. IECWIN, the auxiliary remote control tool provided free of charge and installed by Rohde & Schwarz, is also available from the taskbar.



For details on the IECWIN tool, see the "Network and Remote Control" chapter of the R&S FPL1000 user manual.



5.1.3 Connecting USB Devices

The USB interfaces of the R&S FPL1000 allow you to connect USB devices directly to the instrument. Increase the number of possible connections using USB hubs. Due to the large number of available USB devices, there is almost no limit to the expansions that are possible with the R&S FPL1000.

The following list shows various USB devices that can be useful:

- Memory stick for easy transfer of data to/from a computer (e.g. firmware updates)
- CD-ROM drives for easy installation of firmware applications
- Keyboard or mouse to simplify the entry of data, comments, filenames, etc.
- Printer for printing measurement results
- Power sensors, e.g. of the NRP Zxy family

Installing USB devices is easy under Windows, because all USB devices are plug&play. After a device is connected to the USB interface, the operating system automatically searches for a suitable device driver.

If Windows does not find a suitable driver, it prompts you to specify a directory that contains the driver software. If the driver software is on a CD, connect a USB CD-ROM drive to the instrument before proceeding.

When a USB device is then disconnected from the R&S FPL1000, Windows immediately detects the change in hardware configuration and deactivates the corresponding driver.

All USB devices can be connected to or disconnected from the instrument during operation.

Connecting a memory stick or CD-ROM drive

If installation of a memory stick or CD-ROM drive is successful, Windows informs you that the device is ready to use. The device is made available as a new drive and is displayed in Windows Explorer. The name of the drive depends on the manufacturer.

Connecting a keyboard

The keyboard is detected automatically when it is connected. The default input language is English – US.

However, you can also connect foreign language keyboards; currently the following languages are supported for the R&S FPL1000:

- German
- Swiss
- French
- Russian

To configure the keyboard language

1. To access the Windows operating system, press the Windows key on the external keyboard.

2. Select "Start > Settings > Time & language > Region & language > Add a language" .

Connecting a mouse

The mouse is detected automatically when it is connected.

To configure the mouse properties

1. To access the Windows operating system, press the Windows key on the external keyboard.
2. Select "Start > Settings > Devices > Mouse & touchpad".

Connecting a printer

When printing a file, the instrument checks whether a printer is connected and turned on and whether the appropriate printer driver is installed. If necessary, printer driver installation is initiated. You only have to install a printer driver once.

To install a printer

1. To access the Windows operating system, press the Windows key on the external keyboard.
2. Select "Start > Settings > Devices > Add a printer or scanner".

You can load updated and improved driver versions or new drivers from an installation disk, USB memory stick or another external storage medium. If the instrument is integrated in a network, you can also install driver data stored in a network directory.

To install the driver

- ▶ Select "Start > Settings > Devices > Device Manager > Update Device drivers" .

5.1.4 Connecting an External Monitor

You can connect an external monitor (or projector) to the "DVI" connector on the rear panel of the R&S FPL1000 (see also [Chapter 5.2.2.6, "DVI"](#), on page 45).



Screen resolution and format

The touchscreen of the R&S FPL1000 is calibrated for a 16:10 format. If you connect a monitor or projector using a different format (e.g. 4:3), the calibration will not be correct and the screen will not react to your touch actions properly.

The touchscreen has a screen resolution of 1280x800 pixels. Most external monitors have a higher screen resolution. If the screen resolution of the monitor is set higher than the instrument's resolution, the application window uses an area of 1280x800 pixels on the monitor display. For full screen display, adjust the monitor's screen resolution.

The R&S FPL1000 supports a minimum resolution of 1280x768 pixels.

1. Connect the external monitor to the R&S FPL1000.
2. Press the [SETUP] key.
3. Press the "Display" softkey.
4. Select the "Configure Monitor" tab in the "Display" dialog box.
The standard Windows "Screen Resolution" dialog box is displayed.

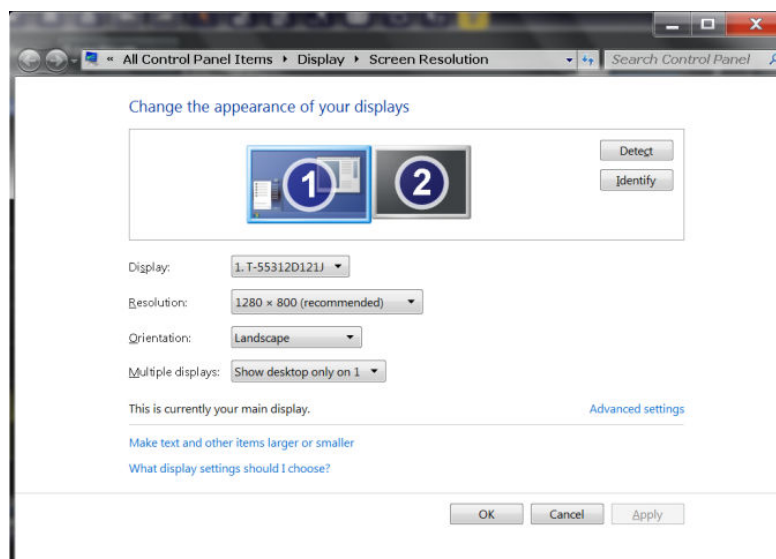

5. If necessary, change the screen resolution to be used. Consider the information in the note above.
6. Select the instrument to be used for display:
 - "Display 1" : internal monitor only
 - "Display 2" : external monitor only
 - "Duplicate" : both internal and external monitor
7. Tap "Apply" to try out the settings before they are accepted permanently, then you can easily return to the previous settings, if necessary.
8. Select "OK" if the settings are suitable.

Fixing a wrong touchscreen mapping

If an external monitor is connected, the touchscreen function is erroneously mapped to the external monitor by default. This mismatch is particularly cumbersome in extended display mode, where touch gestures on the instrument screen actually operate on the external screen. Also in duplicate mode, touch screen operation is malfunctioning if the resolutions of internal and external display do not coincide.

To fix the mapping between touchscreen and display, connect an external monitor to the R&S FPL1000 and proceed as follows:

1. Select [Setup] > "Display" > "Configure Monitor" > "Display Switch" to bring up the Windows 10 "PROJECT" notification window.

Or press [Win]+[P] on a connected keyboard.

2. Select "Extend".
3. In the Windows task bar, search for "tablet" and select "Tablet PC Settings"
4. In the "Tablet PC Settings" dialog, select "Setup...". Enter the administrator password to proceed.

Observe the message "Touch this screen to identify it as the touchscreen" on the **internal** touch screen.

5. Tap on the internal touch screen.
6. Press [ENTER].

Observe the message "Touch this screen to identify it as the touchscreen" on the **external** screen.

7. If the external monitor is also a touchscreen, tap on it.
8. Press [ENTER].

Touch screen operation functions correctly now. Use the "PROJECT" flyout again to select the appropriate display mode.

5.1.5 Setting Up a Network (LAN) Connection

A LAN connection is the prerequisite for all network operations. The LAN connection settings can be configured directly in the Windows operating system.

The R&S FPL1000 is equipped with a network interface and can be connected to an Ethernet LAN (local area network). Provided the network administrator has assigned you the appropriate rights and adapted the Windows firewall configuration, you can use the interface, for example:

- To transfer data between a controlling device and the test device, e.g. to run a remote control program.
See chapter "Remote Control".
- To access or control the measurement from a remote computer using the "Remote Desktop" application (or a similar tool)
- To connect external network devices (e.g. printers)
- To transfer data from a remote computer and back, e.g. using network folders

This section describes how to configure the LAN interface. It includes the following topics:

- [Chapter 5.1.5.1, "Connecting the Instrument to the Network"](#), on page 31
- [Chapter 5.1.5.2, "Assigning the IP Address"](#), on page 32

Note that only user accounts with administrator rights can configure LAN networks.

**LXI**

The R&S FPL1000 supports the LXI core features. LXI gives you direct access to the LAN settings described below.

For further information on the LXI interface, refer to [Chapter 7.4.3.4, "LXI Settings"](#), on page 213.

5.1.5.1 Connecting the Instrument to the Network

There are two methods to establish a LAN connection to the instrument:

- A non-dedicated network (Ethernet) connection from the instrument to an existing network made with an ordinary RJ-45 network cable. The instrument is assigned an IP address and can coexist with a computer and with other hosts on the same network.
- A dedicated network connection (Point-to-point connection) between the instrument and a single computer made with a (crossover) RJ-45 network cable. The computer must be equipped with a network adapter and is directly connected to the instrument. The use of hubs, switches, or gateways is not required, however, data transfer is still performed using the TCP/IP protocol. You must assign an IP address to the instrument and the computer, see [Chapter 5.1.5.2, "Assigning the IP Address"](#), on page 32.

Note: As the R&S FPL1000 uses a 1 GBit LAN, a crossover cable is not necessary (due to Auto-MDI(X) functionality).

NOTICE

Risk of network failure

Consult your network administrator before performing the following tasks:

- Connecting the instrument to the network
- Configuring the network
- Changing IP addresses
- Exchanging hardware

Errors can affect the entire network.

- ▶ To establish a non-dedicated network connection, connect a commercial RJ-45 cable to one of the LAN ports.
To establish a dedicated connection, connect a (crossover) RJ-45 cable between the instrument and a single PC.

If the instrument is connected to the LAN, Windows automatically detects the network connection and activates the required drivers.

The network card can be operated with a 1 GBit Ethernet IEEE 802.3u interface.

5.1.5.2 Assigning the IP Address

Depending on the network capacities, the TCP/IP address information for the instrument can be obtained in different ways.

- If the network supports dynamic TCP/IP configuration using the Dynamic Host Configuration Protocol (DHCP), all address information can be assigned automatically.
- If the network does not support DHCP, or if the instrument is set to use alternate TCP/IP configuration, the addresses must be set manually.

By default, the instrument is configured to use dynamic TCP/IP configuration and obtain all address information automatically. This means that it is safe to establish a physical connection to the LAN without any previous instrument configuration.

NOTICE

Risk of network errors

Connection errors can affect the entire network. If your network does not support DHCP, or if you choose to disable dynamic TCP/IP configuration, you must assign valid address information before connecting the instrument to the LAN. Contact your network administrator to obtain a valid IP address.

Assigning the IP address on the instrument

1. Press the [SETUP] key.
2. Press the "Network + Remote" softkey.
3. Select the "Network" tab.
4. In the "Network + Remote" dialog, toggle the "DHCP On/Off" setting to the required mode.

If DHCP is "Off", you must enter the IP address manually, as described in the following steps.

Note: When DHCP is changed from "On" to "Off", the previously set IP address and subnet mask are retrieved.

If DHCP is "On", the IP address of the DHCP server is obtained automatically. The configuration is saved, and you are prompted to restart the instrument. You can skip the remaining steps.

Note: When a DHCP server is used, a new IP address may be assigned each time the instrument is restarted. This address must first be determined on the instrument itself. Thus, when using a DHCP server, it is recommended that you use the permanent computer name, which determines the address via the DNS server (See ["Using a DNS server to determine the IP address"](#) on page 33 and [Chapter 5.1.5.3, "Using Computer Names"](#), on page 34).

5. Enter the "IP Address", for example *192.0.2.0*. The IP address consists of four number blocks separated by dots. Every block contains a maximum of 3 numbers.

6. Enter the "Subnet Mask", for example *255.255.255.0*. The subnet mask consists of four number blocks separated by dots. Every block contains a maximum of 3 numbers.
7. Select "Configure Network".
If you have entered an invalid IP address or subnet mask, the message "out of range" is displayed in the status line. If the settings are correct, the configuration is saved, and you are prompted to restart the instrument.
8. Confirm the displayed message ("Yes" button) to restart the instrument.

Using a DNS server to determine the IP address

If a DNS server is configured on the R&S FPL1000, the server can determine the current IP address for the connection using the permanent computer name.

1. Obtain the name of your DNS domain and the IP addresses of the DNS and WINS servers on your network.
2. Press the "Windows" key on the external keyboard or the [CTRL + ESC] key combination on your keyboard to access the operating system.
3. Select "Start > Settings > Network & Internet > Ethernet > Network and Sharing Center > Connections: Ethernet".

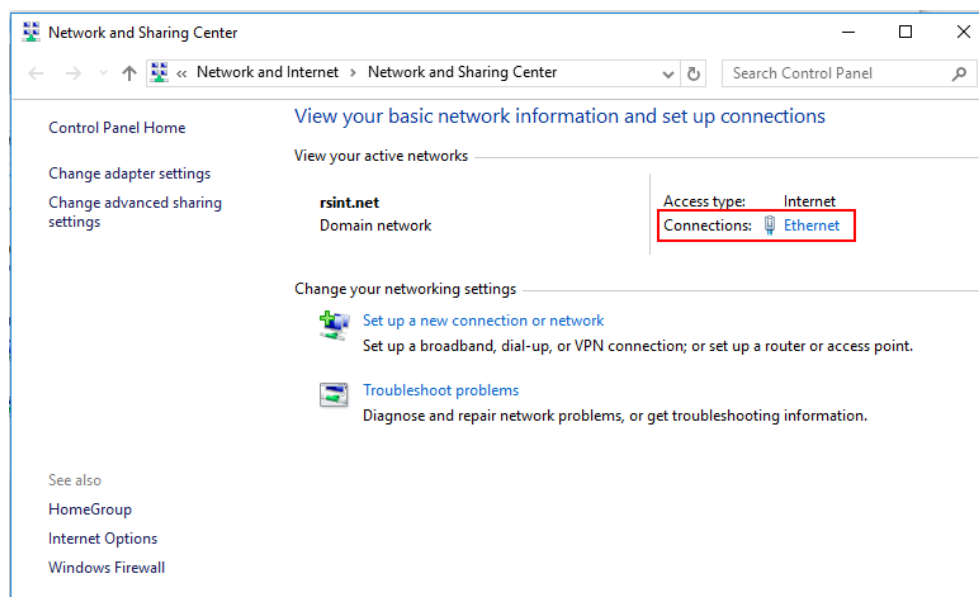

4. In the "Ethernet Status" dialog box, select the "Properties" button.
The items used by the LAN connection are displayed.

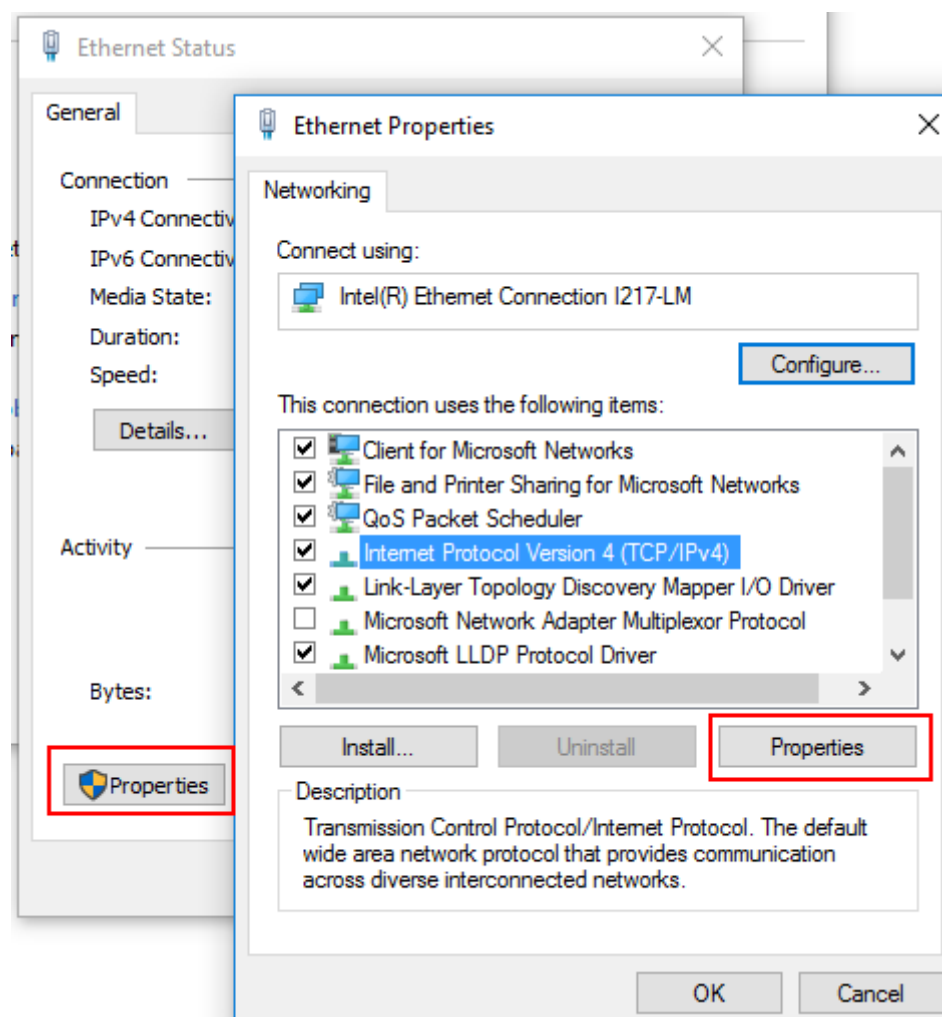

5. Tap the entry named "Internet Protocol Version 4 (TCP/IPv4)" to highlight it.
6. Select the "Properties" button.
7. On the "General" tab, select "Use the following DNS server addresses" and enter your own DNS addresses.

For more information, refer to the Windows operating system help.

5.1.5.3 Using Computer Names

In a LAN that uses a DNS server (Domain Name System server), each PC or instrument connected in the LAN can be accessed via an unambiguous computer name instead of the IP address. The DNS server translates the host name to the IP address. This is especially useful when a DHCP server is used, as a new IP address may be assigned each time the instrument is restarted.

Each instrument is delivered with an assigned computer name, but this name can be changed.

The default instrument name is a non-case-sensitive string with the following syntax:

<Type><variant>-<serial_number>

The serial number can be found on the rear panel of the instrument. It is the third part of the device ID printed on the bar code sticker:



For example, FPL1004-123456

To change the computer name

1. Press the [Setup] key and then the "Network + Remote" softkey.
The current "Computer Name" is displayed in the "Network" tab.
2. Enter the new computer name.
3. Close the dialog box.

5.1.5.4 Changing the Windows Firewall Settings

A firewall protects an instrument by preventing unauthorized users from gaining access to it through a network. Rohde & Schwarz highly recommends the use of the firewall on your instrument. Rohde & Schwarz instruments are shipped with the Windows firewall enabled and preconfigured in such a way that all ports and connections for remote control are enabled.

For more details on firewall configuration, see the following Rohde & Schwarz White Paper:

- [1EF96: Malware Protection Windows 10](#)

Note that changing firewall settings requires administrator rights.

5.1.6 Configuring the Initial Instrument Settings

This section describes how to set up the R&S FPL1000 initially. For further basic instrument settings, see the R&S FPL1000 User Manual.

- [Setting the User Interface Language](#)..... 35
- [Setting the Date and Time](#)..... 36

5.1.6.1 Setting the User Interface Language

The user interface to the R&S FPL1000 is available in several languages.

Changing the user interface language

1. Press the [SETUP] key.

2. Press the "Language" softkey.
3. Select the required language.

All text elements of the R&S FPL1000 user interface are displayed in the selected language.



Texts in standard Windows dialog boxes are displayed in the language defined in the regional settings of the Windows operating system.

5.1.6.2 Setting the Date and Time

Users with administrator rights can set the date and time for the internal real time clock as follows:

Opening the Date and Time Properties dialog box

1. Press the [SETUP] key.
2. Press the "Display" softkey.
3. Select the "General" tab in the "Display" dialog box.
4. Press the "Set Date and Time" button to open the standard Windows "Date and Time Properties" dialog box.
5. If necessary, toggle the "Date and Time Format" between German (DE) and US.

After you have changed the setting and closed the dialog box, the instrument adopts the new date and time.

5.2 Instrument Tour

5.2.1 Front Panel View

This chapter describes the front panel, including all function keys and connectors.

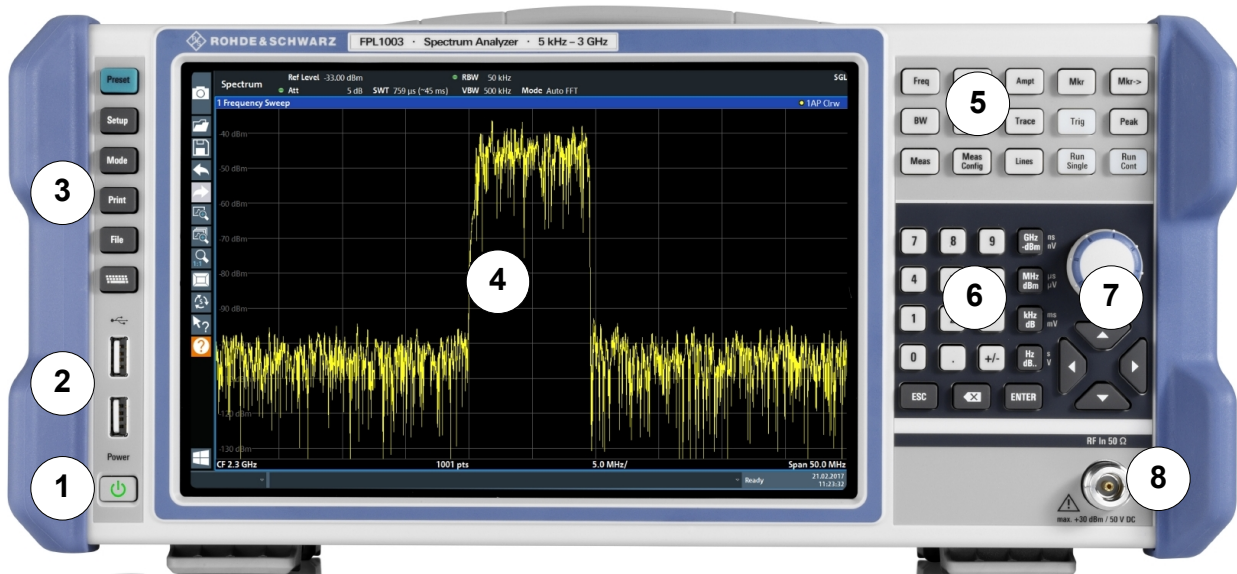

Figure 5-1: Front panel view of R&S FPL1000

- 1 = Power key
- 2 = USB (2.0) connectors
- 3 = System keys
- 4 = Touchscreen
- 5 = Function keys
- 6 = Keypad
- 7 = Navigation controls
- 8 = RF Input 50 Ω connector

NOTICE

Instrument damage caused by cleaning agents

Cleaning agents contain substances such as solvents (thinners, acetone, etc.), acids, bases, or other substances. Solvents can damage the front panel labeling, plastic parts, or screens, for example.

Never use cleaning agents to clean the outside of the instrument. Use a soft, dry, lint-free dust cloth instead.

5.2.1.1 Touchscreen

All measurement results are displayed on the screen on the front panel. Additionally, the screen display provides status and setting information and allows you to switch between various measurement tasks. The screen is touch-sensitive, offering an alternative means of user interaction for quick and easy handling of the instrument.

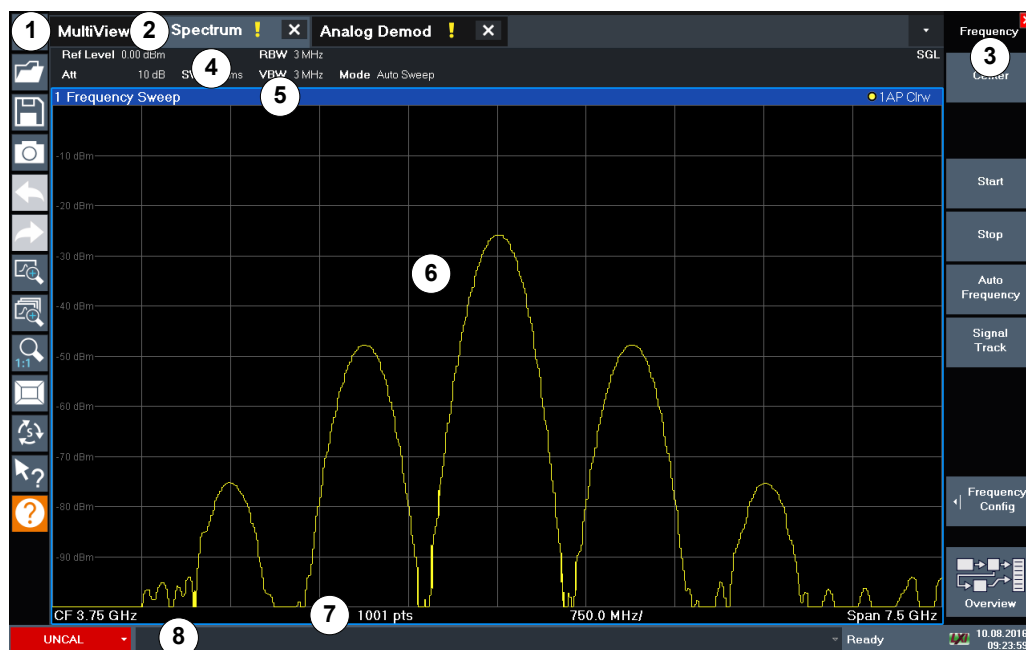

Figure 5-2: Touchscreen elements

- 1 = Toolbar with standard application functions, e.g. print, save/open file etc.
- 2 = Tabs for individual channel setups
- 3 = Softkeys for function access
- 4 = Channel Setup bar for firmware and measurement settings
- 5 = Window title bar with diagram-specific (trace) information
- 6 = Measurement results area
- 7 = Diagram footer with diagram-specific information, depending on application
- 8 = Instrument status bar with error messages and date/time display

A touchscreen is a screen that is touch-sensitive, that is: the firmware reacts in a specified way when you move your fingers on the screen. Using touchscreen gestures, you can perform the following tasks (among others).

(See [Chapter 5.3, "Trying Out the Instrument"](#), on page 48)

- Changing a setting
- Changing the display
- Changing the displayed result range in a diagram
- Moving a marker
- Zooming into a diagram
- Selecting a new evaluation method
- Scrolling through a result list or table
- Saving or printing results and settings

To imitate a right-click by mouse using the touchscreen, for example to open a context-sensitive menu for a specific item, press the screen for about 1 second.

For details on touchscreen gestures see [Chapter 5.4.4, "Touchscreen Gestures"](#), on page 78.

5.2.1.2 Power Key

The [Power] key is located on the lower left corner of the front panel. It starts up and shuts down the instrument.

See also [Chapter 5.1.1.8, "Switching the Instrument On and Off"](#), on page 21.

5.2.1.3 USB

The front panel provides two female USB connectors (USB-A, 2.0 standard) to connect devices like a keyboard or a mouse. A memory stick can be connected to store and reload instrument settings and measurement data.



The rear panel provides further USB connectors (standard 3.0), see [Chapter 5.2.2.8, "USB"](#), on page 45.

5.2.1.4 System Keys

[System] keys set the instrument to a predefined state, change basic settings, and provide print and display functions.

A detailed description of the corresponding functions is provided in the User Manual.

Table 5-1: System keys

System key	Assigned functions
[Preset]	Resets the instrument to the default state.
[Setup]	Provides basic instrument configuration functions, e.g.: <ul style="list-style-type: none"> • Reference frequency (external/internal) • Date, time, display configuration • LAN interface • Firmware update and enabling of options • Information about instrument configuration incl. firmware version and system error messages • Service support functions (self-test etc.) • Self-alignment (with spectrum analysis option)
[Mode]	Manages channel setups
[Print]	Provides configuration settings for the print function
[FILE]	Provides save/recall functions for instrument settings and measurement results
	Switches between the on-screen keyboard display: <ul style="list-style-type: none"> • At the top of the screen • At the bottom of the screen • Off

5.2.1.5 Function Keys

Function keys provide access to the most common measurement settings and functions.

A detailed description of the corresponding functions is provided in the User Manual.

Table 5-2: Function keys

Function key	Assigned functions
[FREQ]	Sets the center frequency and the start and stop frequencies for the frequency range under consideration. This key is also used to set the frequency offset and the signal track function.
[SPAN]	Sets the frequency span to be analyzed
[AMPT]	Sets the reference level, the displayed dynamic range, the RF attenuation and the unit for the level display Sets the level offset and the input impedance Activates the (optional) preamplifier
[BW]	Sets the resolution bandwidth and the video bandwidth.
[SWEEP]	Sets the sweep time and the number of measurement points Selects continuous measurement or single measurement
[TRACE]	Configures the graphical analysis of the measurement data
[MEAS]	Provides the measurement functions: Measurement of multicarrier adjacent channel power (Ch Power ACLR) Carrier to noise spacing (C/N C/N ₀) Occupied bandwidth (OBW) Spectrum emission mask measurement (Spectrum Emission Mask) Spurious emissions (Spurious Emissions) Measurement of time domain power (Time Domain Power) Third-order intercept point (TOI) AM modulation depth (AM Mod Depth)
[MEAS CONFIG]	Used to configure measurements and data input and output
[LINES]	Configures display lines and limit lines
[MKR]	Sets and positions the absolute and relative measurement markers (markers and delta markers) Selects special marker functions
[MKR->]	Used for search functions of the measurement markers (maximum/minimum of the trace) Assigns the marker frequency to the center frequency, and the marker level to the reference level Restricts the search area (Search Limits) and characterizes the maximum points and minimum points (Peak Excursion)
[TRIG]	Sets the trigger mode, the trigger threshold, the trigger delay, and the gate configuration in the case of gated sweep
[PEAK]	Performs a peak search for active marker. If no marker is active, normal marker 1 is activated and the peak search is performed for it.

Function key	Assigned functions
[RUN SINGLE]	Starts and stops a single new measurement (Single Sweep Mode)
[RUN CONT]	Starts and stops a continuous measurement (Continuous Sweep Mode)

5.2.1.6 Keypad

The keypad is used to enter numeric parameters, including the corresponding units. It contains the following keys:

Table 5-3: Keys on the keypad

Type of key	Description
Decimal point	Inserts a decimal point "." at the cursor position.
Sign key	Changes the sign of a numeric parameter. In the case of an alphanumeric parameter, inserts a "-" at the cursor position.
Unit keys (GHz/-dBm MHz/dBm, kHz/dB, Hz/dB etc.)	Adds the selected unit to the entered numeric value and complete the entry. In the case of level entries (e.g. in dB) or dimensionless values, all units have the value "1" as multiplying factor. Thus, they have the same function as an [ENTER] key.
[ESC]	Closes all kinds of dialog boxes, if the edit mode is not active. Quits the edit mode, if the edit mode is active. In dialog boxes that contain a "Cancel" button it activates that button. For "Edit" dialog boxes the following mechanism is used: <ul style="list-style-type: none"> • If data entry has been started, it retains the original value and closes the dialog box. • If data entry has not been started or has been completed, it closes the dialog box.
 (BACKSPACE)	If an alphanumeric entry has already been started, this key deletes the character to the left of the cursor.
[ENTER]	<ul style="list-style-type: none"> • Concludes the entry of dimensionless entries. The new value is accepted. • With other entries, this key can be used instead of the "Hz/dB" unit key. • In a dialog box, selects the default or focused element.

5.2.1.7 Navigation Controls

The navigation controls include a rotary knob and navigation keys. They allow you to navigate within the display or within dialog boxes.



Navigating in tables

The easiest way to navigate within tables (both in result tables and configuration tables) is to scroll through the entries with your finger on the touchscreen.

Rotary Knob



The rotary knob has several functions:

- For numeric entries: increments (clockwise direction) or decrements (counter-clockwise direction) the instrument parameter at a defined step width
- In lists: toggles between entries
- For markers, limit lines, and other graphical elements on the screen: moves their position
- For active scroll bars: moves the scroll bar vertically
- For dialog boxes: Acts like the [ENTER] key when pressed

Navigation Keys

The navigation keys can be used alternatively to the rotary knob to navigate through dialog boxes, diagrams or tables.

Arrow Up/Arrow Down Keys

The <arrow up> or <arrow down> keys do the following:

- For numeric entries: increments (Arrow Up) or decrements (Arrow Down) the instrument parameter at a defined step width
- In a list: scrolls forward and backward through the list entries
- In a table: moves the selection bar vertically
- In windows or dialog boxes with a vertical scroll bar: moves the scroll bar

Arrow Left/Arrow Right Keys

The <arrow left> or <arrow right> keys do the following:

- In an alphanumeric edit dialog box, move the cursor.
- In a list, scroll forward and backward through the list entries.
- In a table, move the selection bar horizontally.
- In windows or dialog boxes with horizontal scroll bar, move the scroll bar.

5.2.1.8 RF INPUT 50 Ω

Connect a device under test (DUT) to the R&S FPL1000 to provide RF input which is then analyzed in an RF measurement. Connect the DUT to the "RF Input" on the R&S FPL1000 via a cable equipped with an appropriate connector.

NOTICE**Risk of instrument damage**

Do not overload the input. For maximum allowed values, see the data sheet. A DC input voltage of 50 V must never be exceeded.

5.2.2 Rear Panel View

This figure shows the rear panel view of the R&S FPL1000. The individual elements are described in more detail in the subsequent sections.

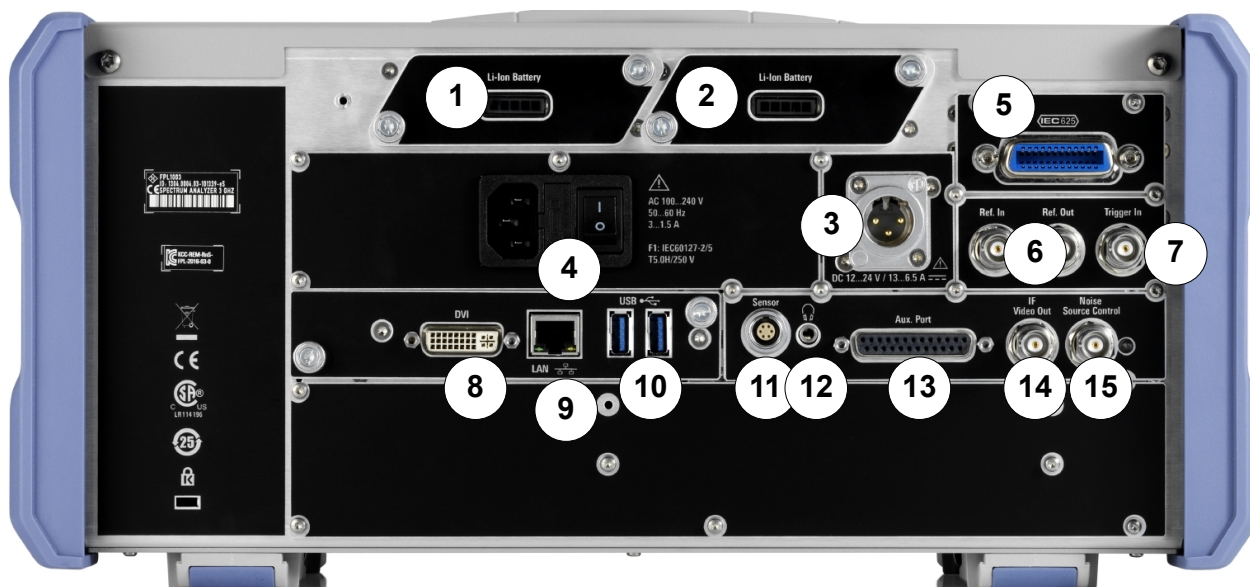

Figure 5-3: Rear panel view

- 1+2 = Removable, rechargeable Li-Ion Battery Packs
- 3 = DC power supply
- 4 = AC Power Supply Connection and Main Power Switch with fuse
- 5 = GPIB (IEC 625) interface
- 6 = Reference clock connectors
- 7 = Trigger input connector
- 8 = "DVI" connector for external display
- 9 = "LAN" connector
- 10 = "USB" (3.0) connectors
- 11 = NRP Power Sensor connector *)
- 12 = Headphones connector *)
- 13 = Aux. Port *)
- 14 = "IF/VIDEO OUT" connector *)
- 15 = NOISE SOURCE CONTROL *)

*) requires the "Additional Interfaces" option R&S FPL1-B5.

5.2.2.1 Li-Ion Battery Packs and DC Power Connector

With the Li-Ion battery pack (option R&S FPL1-B31), the R&S FPL1000 can be operated independently of an AC or DC power supply. The instrument can house 2 Li-Ion battery packs which can be charged both via AC or DC power supply.

The DC power supply (option R&S FPL1-B30) can be connected alternatively to the AC power supply. DC power supplies from +12 V to +24 V and from 13 A to 6.5 A can be used. The connector is supplied with the accessories and is connected according to the following diagram:

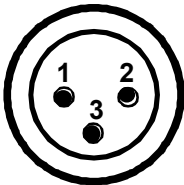
	Pin	Description
	1	Plus
	2	Ground
	3	Not used

⚠ WARNING

Risk of electric shock!

If external power supply units for supplying safety extra-low DC voltage (SELV) to the instrument are used, the requirements for reinforced/double insulation in accordance with DIN/EN/IEC 61010 (UL 3111, CSA C22.2 No. 1010.1) or DIN/EN/IEC 60950 (UL 1950, CSA C22.2 No. 950) must be met. Current limitation must be provided in accordance with DIN EN 61010-1 Appendix F2.1.

Otherwise there is a risk of electric shock.

5.2.2.2 AC Power Supply Connection and Main Power Switch

An AC power supply connector and main power switch are located in a unit on the rear panel of the instrument.

Main power switch function:

Position 1: The instrument is in operation.

Position O: The entire instrument is disconnected from the AC power supply.

For details, refer to [Chapter 5.1.1.4, "Connecting the AC Power"](#), on page 18.

5.2.2.3 GPIB Interface

The optional GPIB interface (R&S FPL1-B10) is in compliance with IEEE488 and SCPI. A computer for remote control can be connected via this interface. To set up the connection, a shielded cable is recommended.

For details see "[GPIB Interface \(IEC 625/IEEE 418 Bus Interface\)](#)" on page 173.

5.2.2.4 Ref. In / Ref. Out

The Ref. In connectors are used to provide an external reference signal to the R&S FPL1000.

The Ref. Out connectors can be used to provide a reference signal from the R&S FPL1000 to other devices that are connected to this instrument.

Various connectors are provided for different reference signals:

Connector	Reference signal	Usage
Ref. In	10 MHz 10 dBm	To provide an external reference signal on the R&S FPL1000.
Ref. Out	10 MHz 10 dBm	To provide the internal reference signal from the R&S FPL1000 to another device continuously. For the R&S FPL1000 this is also used to provide the optional OCXO reference signal to another device.

5.2.2.5 Trigger In

Use the female Trigger In connector to input an external trigger or gate data. Thus, you can control the measurement using an external signal. The voltage level is 1.4 V. The typical input impedance is 10 kΩ.

5.2.2.6 DVI

You can connect an external monitor or other display device to the R&S FPL1000 via the DVI (Digital visual interface) connector to provide an enlarged display.

For details, see [Chapter 5.1.4, "Connecting an External Monitor"](#), on page 28.

5.2.2.7 LAN

The "LAN" interface can be used to connect the R&S FPL1000 to a local network for remote control, printouts or data transfer. The assignment of the RJ-45 connector supports twisted-pair category 5 UTP/STP cables in a star configuration (UTP stands for *unshielded twisted pair*, and STP for *shielded twisted pair*).

For details, see [Chapter 7.4, "Network and Remote Operation"](#), on page 167.

5.2.2.8 USB

The rear panel provides two additional female USB (3.0 standard) connectors to connect devices like a keyboard, a mouse or a memory stick (see also [Chapter 5.2.2.8, "USB"](#), on page 45).

5.2.2.9 Sensor Connector

The LEMOSA female connector is used to connect power sensors of the R&S NRP-Zxy family. For a detailed list of supported sensors, see the data sheet.

For details on configuring and using power sensors, see [Chapter 8.3.2, "Power Sensors"](#), on page 411.



This connector is provided by the "Additional Interfaces" option R&S FPL1-B5.

5.2.2.10 Aux. Port

A 25-pole SUB-D male connector used as an input and output for low-voltage TTL control signals (max. 5 V). This connector is provided by the "Additional Interfaces" option R&S FPL1-B5.

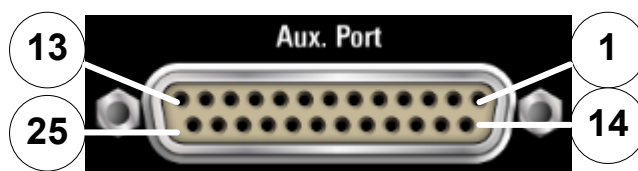

Table 5-4: Pin assignment for optional AUX port

Pin	Signal	Description
1	GND	Ground
2		not used for spectrum analysis
3	GND	Ground
4		not used for spectrum analysis
5	GND	Ground
6		not used for spectrum analysis
7	GND	Ground
8 to 11		not used for spectrum analysis
12	GND	Ground
13	+5 V / max. 250 mA	Supply voltage for external circuits
14 to 19	I/O_<no.>	Control lines for user ports (see User manual)
20	GND	Ground
21	READY FOR TRIGGER	Signal indicating that the instrument is ready to receive a trigger signal. The signal polarity is configurable.
22 to 25		not used for spectrum analysis

Pin	Signal	Description
23	GND	Ground
24 to 25		not used for spectrum analysis

NOTICE

Short-circuit hazard

Always observe the designated pin assignment. A short-circuit can damage the port.

5.2.2.11 IF/Video Output

The female BNC connector can be used for various outputs in the Spectrum application:

- Intermediate frequency (IF) output of approximately 20 MHz
- Video output (1V)

Which output is provided is defined in the software ("Overview" > "Output").

This connector is only available if the R&S FPL1-B5 option is installed.

For details, see ["Data Output"](#) on page 417.

5.2.2.12 Headphones Connector

The R&S FPL1000 provides demodulators for AM, FM and PM signals, which can be routed to the headphone connector. With headphones or an external loudspeaker connected to the 3.5 mm headphone socket the displayed signal can be identified acoustically.

This connector is only available if the R&S FPL1-B5 option is installed.

For details, see ["Data Output"](#) on page 417.

5.2.2.13 Noise Source Control

The Noise Source Control female connector is used to provide the supply voltage for an external noise source. For example, use it to measure the noise figure and gain of amplifiers and frequency converting devices.

This connector is only available if the R&S FPL1-B5 option is installed.

Conventional noise sources require a voltage of +28 V to be switched on and 0 V to be switched off. The output supports a maximum load of 100 mA.

5.3 Trying Out the Instrument

This chapter introduces the most important functions and settings of the R&S FPL1000 step by step. The complete description of the functionality and its usage is given in the R&S FPL1000 User Manual. Basic instrument operation is described in [Chapter 5.4, "Operating the Instrument"](#), on page 66.

Prerequisites

- The instrument is set up, connected to the mains system, and started up as described in [Chapter 5.1, "Preparing for Use"](#), on page 14.

For these first measurements, you use the internal calibration signal, so you do not need any additional signal source or instruments. Try out the following:

• Measuring a Basic Signal	48
• Displaying a Spectrogram	50
• Activating Additional Measurement Channels	52
• Performing Sequential Measurements	56
• Setting and Moving a Marker	57
• Displaying a Marker Peak List	59
• Zooming into the Display	60
• Saving Settings	63
• Printing and Saving Results	65

5.3.1 Measuring a Basic Signal

We will start out by measuring a basic signal, using the internal calibration signal as the input.

To display the internal 50 MHz calibration signal

1. Press the [PRESET] key to start out in a defined instrument configuration.
2. Press the [Setup] key.
3. Tap the "Service + Support" softkey.
4. Tap the "Calibration Signal" tab.
5. Tap the "Calibration Frequency RF" option. Leave the frequency at the default 50 MHz.
6. Close the dialog box.

The calibration signal is now sent to the RF input of the R&S FPL1000. By default, a continuous frequency sweep is performed, so that the spectrum of the calibration signal is now displayed in the standard level versus frequency diagram.

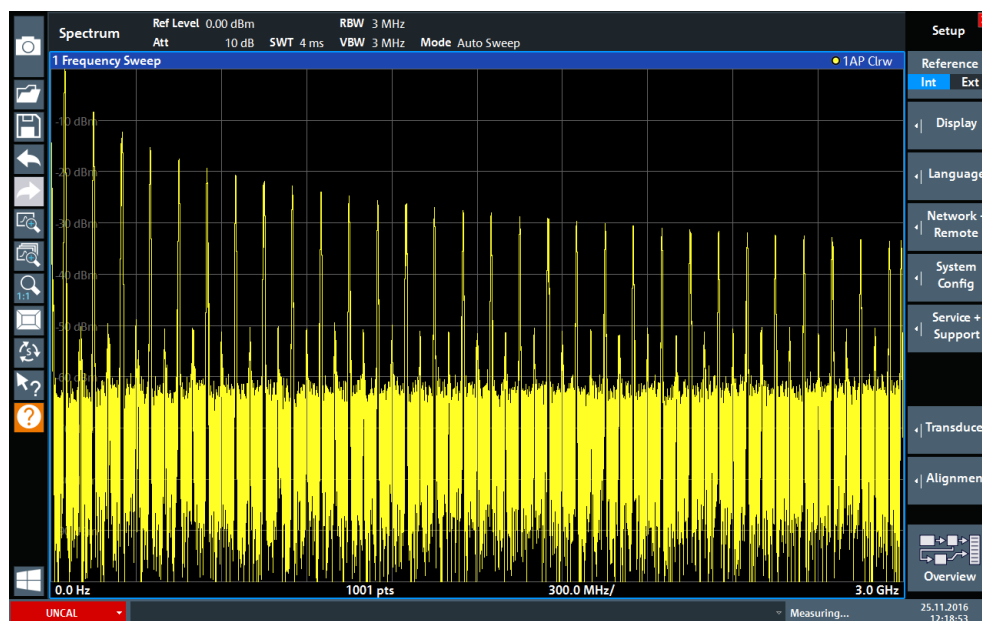

Figure 5-4: Calibration signal as RF input



Instrument warmup time

Note that the instrument requires an initial warmup time after switching it on. A message in the status bar ("Instrument warming up...") indicates that the operating temperature has not yet been reached. Wait until this message is no longer displayed before you start a measurement to ensure accurate results.

To optimize the display

To optimize the display for the calibration signal, we will adjust the main measurement settings.

1. Set the center frequency to the calibration frequency:
 - a) Tap the "Overview" softkey to display the configuration "Overview" .
 - b) Tap the "Frequency" button.
 - c) In the "Center" field, enter 50 on the number pad on the front panel.
 - d) Press the "MHz" key next to the number pad.
2. Reduce the span to 20 MHz:
 - a) In the "Span" field of the "Frequency" dialog box, enter 20 MHz.
 - b) Close the "Frequency" dialog box.
3. Average the trace to eliminate noise:
 - a) In the configuration "Overview" , tap the "Analysis" button.
 - b) In the "Traces" tab, select the trace mode "Average" .
 - c) Enter the "Average Count" : 100.

d) Close the "Analysis" dialog box.

The display of the calibration signal is now improved. The maximum at the center frequency (=calibration frequency) of 50 MHz becomes visible.

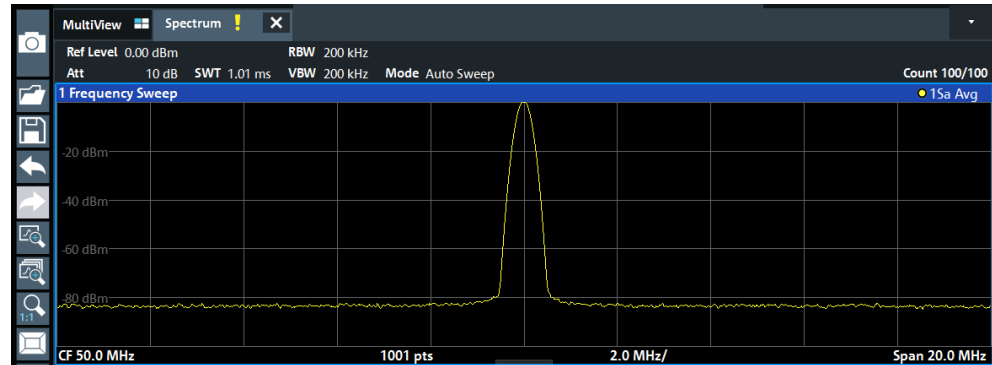



Figure 5-5: Calibration signal with optimized display settings

5.3.2 Displaying a Spectrogram

In addition to the standard "level versus frequency" spectrum display, the R&S FPL1000 also provides a spectrogram display of the measured data. A spectrogram shows how the spectral density of a signal varies over time. The x-axis shows the frequency, the y-axis shows the time. A third dimension, the power level, is indicated by different colors. Thus you can see how the strength of the signal varies over time for different frequencies.

1. Tap the "Overview" softkey to display the general configuration dialog box.
2. Tap the "Display Config" button.

The SmartGrid mode is activated, and the evaluation bar with the available evaluation methods is displayed.

3.  Spectrogram

Drag the "Spectrogram" icon from the evaluation bar to the diagram area. The blue area indicates that the new diagram would replace the previous spectrum display. Since we do not want to replace the spectrum, drag the icon to the lower half of the display to add an additional window instead.

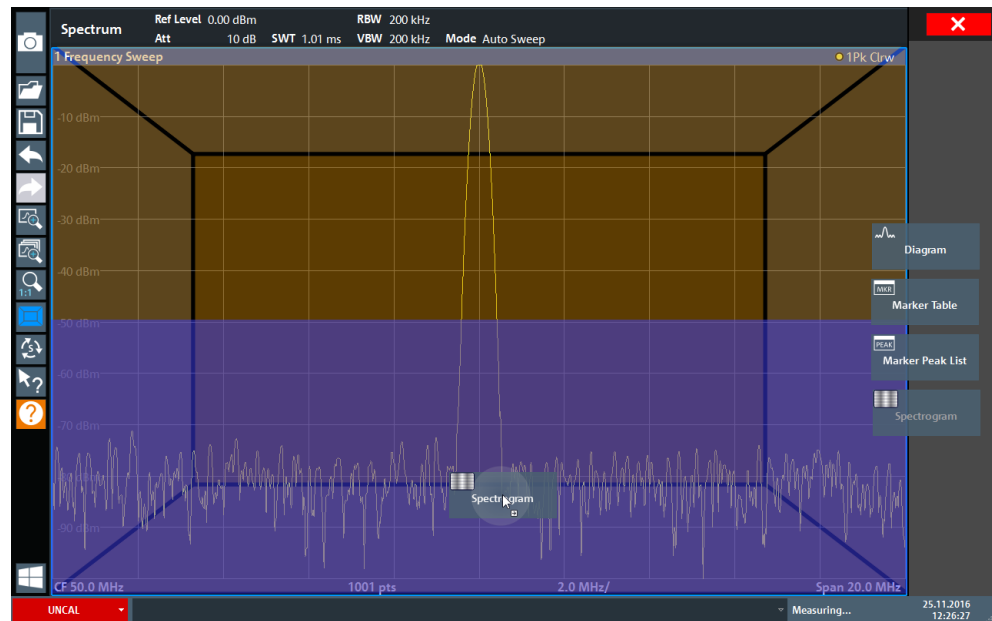

Figure 5-6: Adding a Spectrogram to the display

Drop the icon.



4. Close the SmartGrid mode by tapping the "Close" icon at the top right corner of the toolbar.
5. Close the "Overview" .

You see the spectrogram compared to the standard spectrum display. Since the calibration signal does not change over time, the color of the frequency levels does not change over time, i.e. vertically. The legend at the top of the spectrogram window describes the power levels the colors represent.

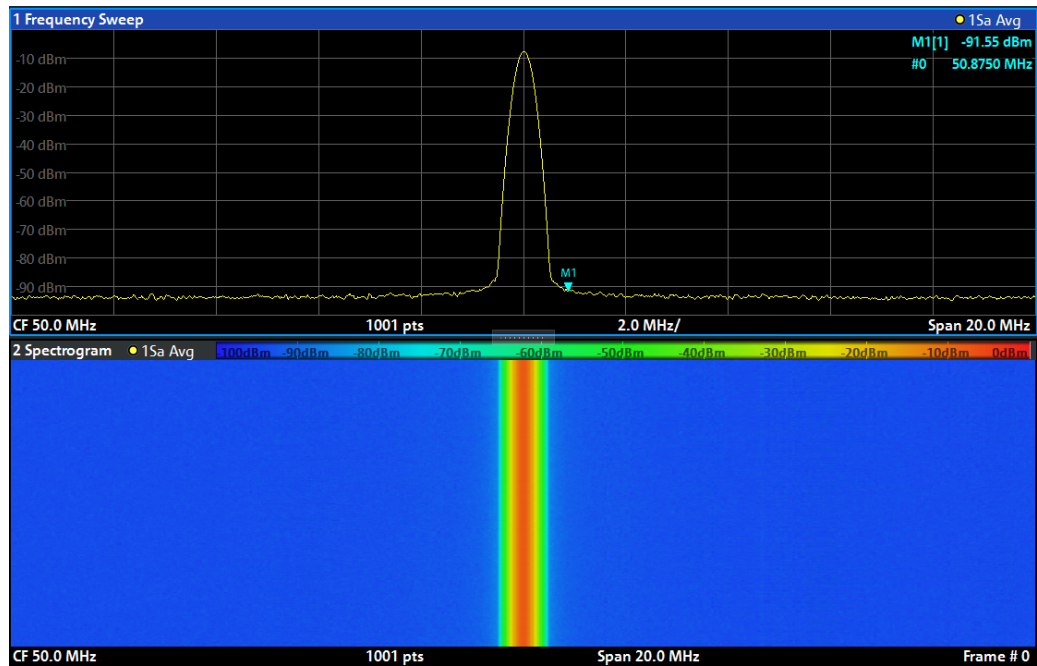

Figure 5-7: Spectrogram of the calibration signal

5.3.3 Activating Additional Measurement Channels

The R&S FPL1000 features multiple measurement channels, i.e. you can define several measurement configurations in parallel and then switch between the channel setups automatically to perform the measurements sequentially. We will demonstrate this feature by activating additional measurement channels for a different frequency range, a zero span measurement, and an I/Q analysis.

To activate additional measurement channels

1. Press the [Mode] key on the front panel.
2. On the "New Channel Setup" tab of the "Mode" dialog box, tap the "Spectrum" button.

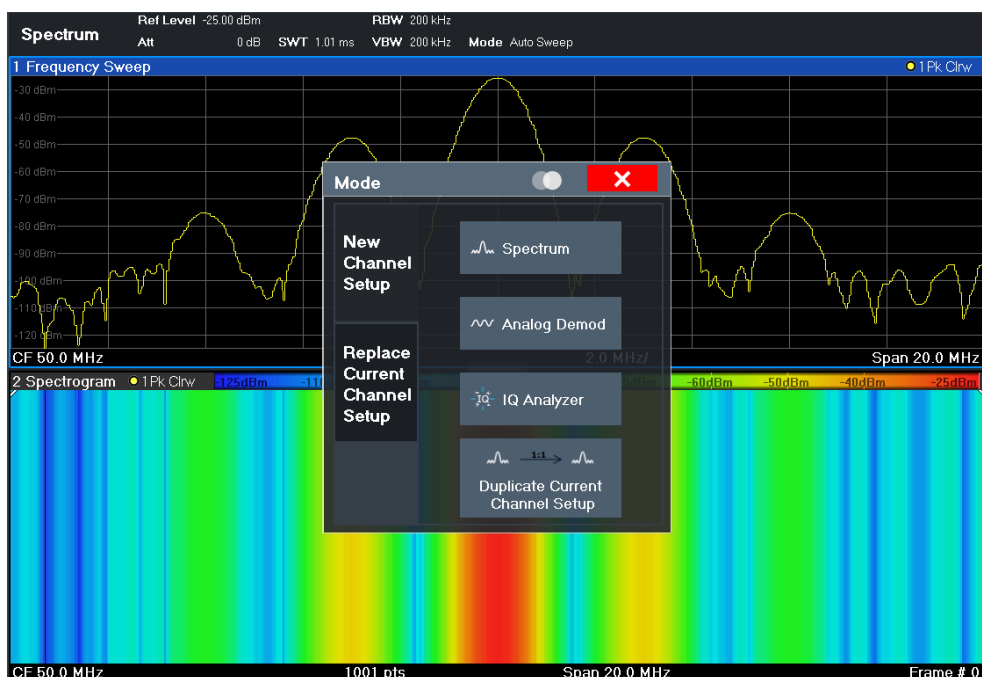

Figure 5-8: Adding a new measurement channel

3. Change the frequency range for this spectrum display:
In the "Frequency" dialog box, set the **center frequency** to 500 MHz and the **span** to 1 GHz.

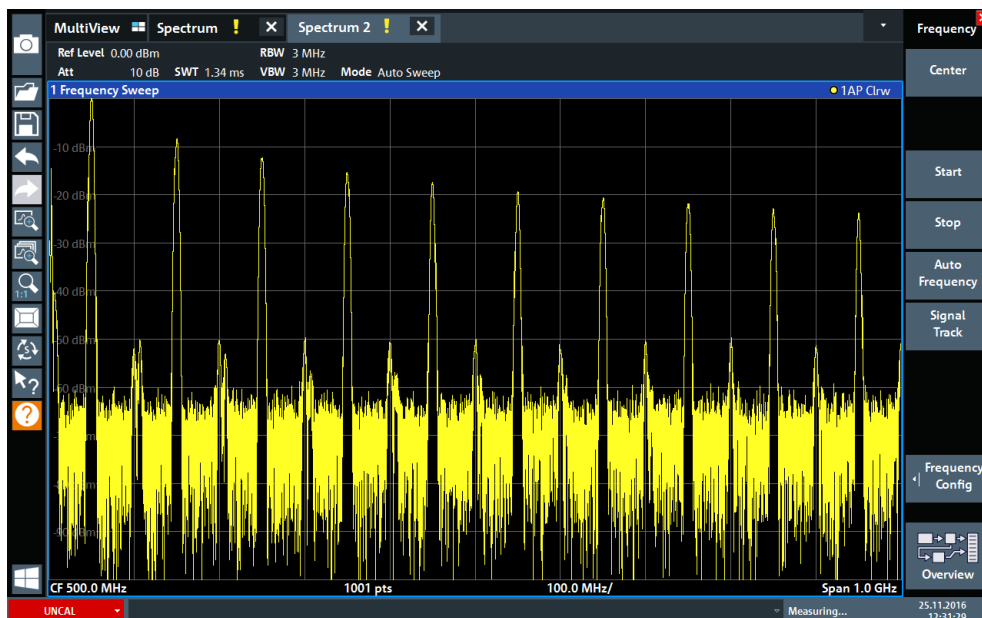

Figure 5-9: Frequency spectrum of the calibration signal with a larger span

4. Repeat the previous steps to activate a third Spectrum window.
5. Change the frequency range for this spectrum display:

In the "Frequency" dialog box, set the **center frequency** to *50 MHz* and tap "Zero Span".

6. Increase the reference level so you can see the level of the calibration signal at 1 dBm.

a) In the "Amplitude" dialog box, set the "Reference Level" value to *+10 dBm*.

As the calibration signal does not vary over time, the level versus time diagram displays a straight line.



Figure 5-10: Time domain display of the calibration signal

7. Create a new measurement channel for I/Q analysis:
 - a) Press the [Mode] key.
 - b) Tap the "IQ Analyzer" button to activate a measurement channel for the I/Q Analyzer application.
 - c) Tap the "Display Config" softkey to activate the SmartGrid mode.

- d) Drag the "Real/Imag (I/Q)" icon from the evaluation bar to the SmartGrid to replace the default "Magnitude" display.

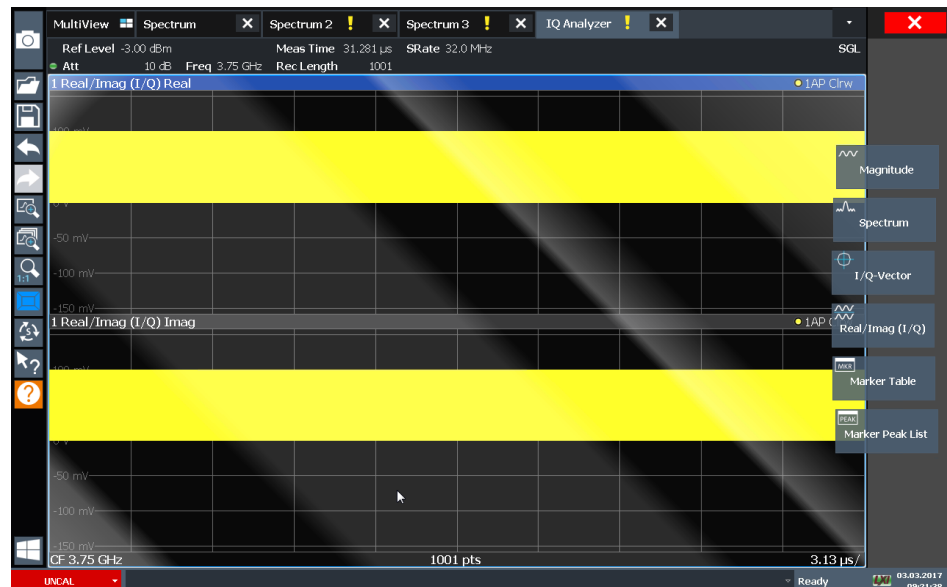

Figure 5-11: Inserting a Real/Imag diagram for I/Q analysis

- e) Close the SmartGrid mode.

The "IQ Analyzer" measurement channel displays the real and imaginary signal parts in separate windows.

To display the MultiView tab

An overview of all active measurement channels is provided in the "MultiView" tab. This tab is always displayed if more than one measurement channel is active and cannot be closed.

- ▶ Tap the "MultiView" tab.



Figure 5-12: The "MultiView" tab

5.3.4 Performing Sequential Measurements

Although only one measurement can be performed at any one time, the measurements configured in the active channel setups can be performed sequentially, that means: one after the other, automatically, either once or continuously.



1. Tap the "Sequencer" icon in the toolbar.
2. Toggle the "Sequencer" softkey in the "Sequencer" menu to "On" .

A continuous sequence is started, i.e. each channel setup measurement is performed one after the other until the Sequencer is stopped.



Figure 5-13: "MultiView" tab with active Sequencer



In Figure 5-13, the "Spectrum 2" measurement is currently active (indicated by the "channel active" icon in the tab label).

3. Stop the Sequencer by tapping the "Sequencer" softkey again.

5.3.5 Setting and Moving a Marker

Markers are useful to determine the position of particular effects in the trace. The most common use is to determine a peak, which is the default setting when you activate a marker. We will set a marker on the peak in our first Spectrum measurement.

1. In the "MultiView" tab, double-tap the "Spectrum" window (frequency sweep with spectrogram display) to return to the "Spectrum" measurement channel.
2. Tap the spectrum display to set the focus on that window.
3. Double-tap the spectrum window to maximize it, as we currently do not need the spectrogram display.
4. Press the [RUN SINGLE] key on the front panel to perform a single sweep so we have a fixed trace to set a marker on.
5. Press the [MKR] key on the front panel to display the "Marker" menu.

Marker 1 is activated and automatically set to the maximum of trace 1. The marker position and value is indicated in the diagram area as M1[1].

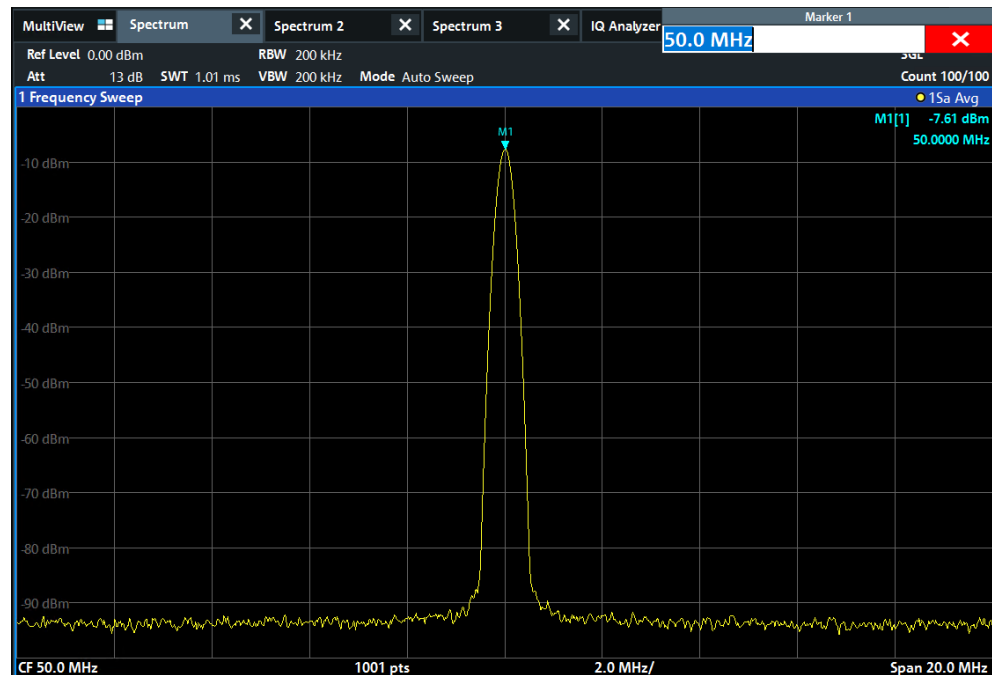

- Now you can move the marker by tapping and dragging it to a different position. The current position is indicated by a dotted blue line. Notice how the position and value change in the marker area of the diagram.

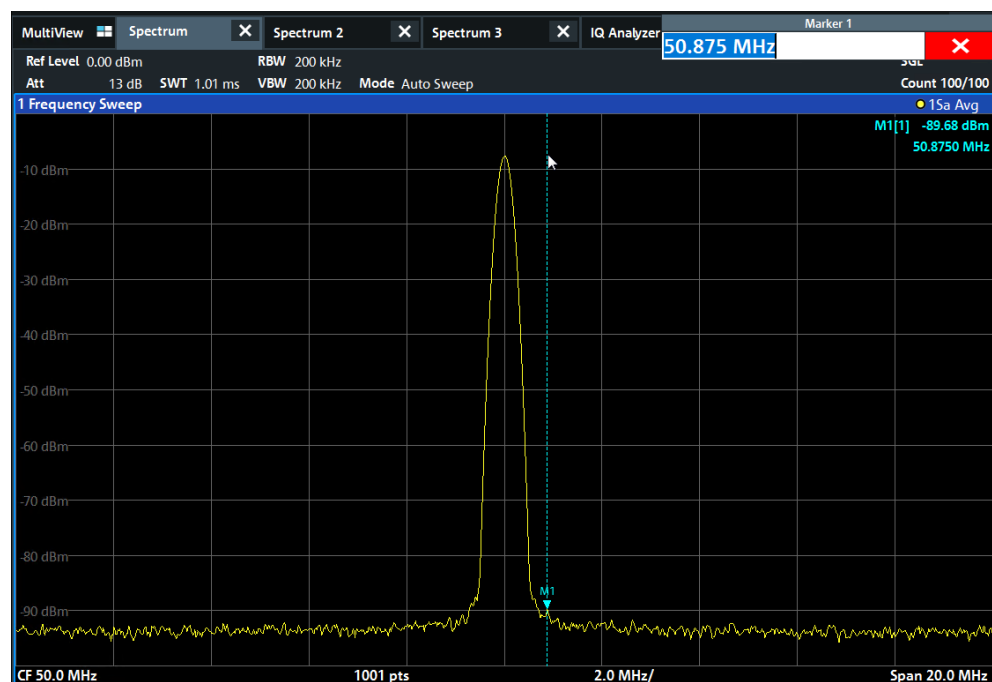

5.3.6 Displaying a Marker Peak List

The marker peak list determines the frequencies and levels of peaks in the spectrum automatically. We will display a marker peak list for the "Spectrum 2" measurement channel.

1. Tap the "Spectrum 2" tab.
2. Press the [RUN SINGLE] key on the front panel to perform a single sweep for which we will determine the peaks.
-  3. Tap the "SmartGrid" icon in the toolbar to activate SmartGrid mode.
4. Drag the "Marker Peak List" icon from the evaluation bar to the lower half of the display to add a new window for the peak list.
5. Close the SmartGrid mode.
6. To obtain a more conclusive peak list that does not contain noise peaks, for example, define a threshold that is higher than the noise floor:
 - a) Press the [MKR] key on the front panel.
 - b) Tap the "Marker Config" softkey in the "Marker" menu.
 - c) Tap the "Search" tab in the "Marker" dialog box.
 - d) In the "Threshold" field, enter *-68 dBm*.
 - e) Tap the "State" box for "Threshold" to activate its use.
Only peaks that are larger than -90 dBm will be included in the peak list.
 - f) Close the "Marker" dialog box.

The marker peak list displays the determined peaks that are above the defined threshold.

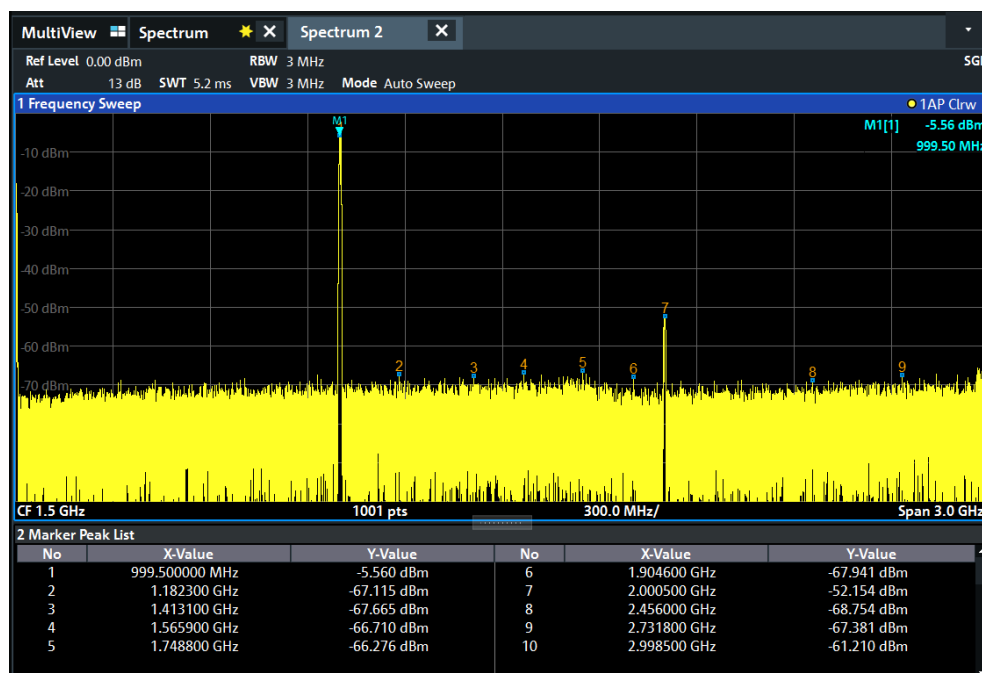

Figure 5-14: Marker Peak List

5.3.7 Zooming into the Display

To analyze the areas around the peak levels in more detail, we will zoom into the top 3 peaks.



1. Tap the "Multiple Zoom" icon in the toolbar.

The icon is highlighted to indicate that multiple zoom mode is active.

2. Tap the diagram near the first peak and drag your finger to the opposite corner of the zoom area. A white rectangle is displayed from the point where you tapped to the current position.

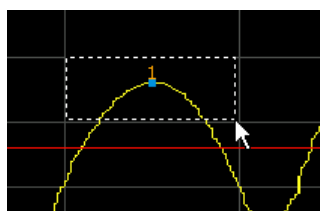

Figure 5-15: Defining the zoom area

When you remove your finger, the zoom area is enlarged in a second (sub-)window.

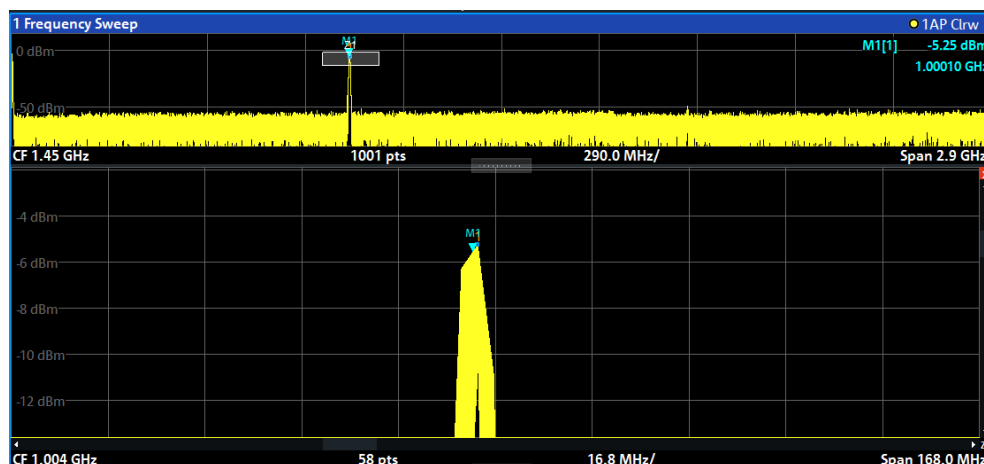

Figure 5-16: Zoomed display around a peak

3. In Figure 5-17, the enlarged peak is represented by a very thick trace. This is due to the insufficient number of sweep points. The missing sweep points for the zoomed display are interpolated, which provides poor results. To optimize the results, we will increase the number of sweep points from the default 1001 to 32001.
 - a) Press the [Sweep] key on the front panel.
 - b) Tap the "Sweep Config" softkey in the "Sweep" menu.
 - c) In the "Sweep Points" field, enter 32001.
 - d) Close the "Bandwidth" dialog box.
 - e) Press the [RUN SINGLE] key on the front panel to perform a new sweep with the increased number of sweep points.

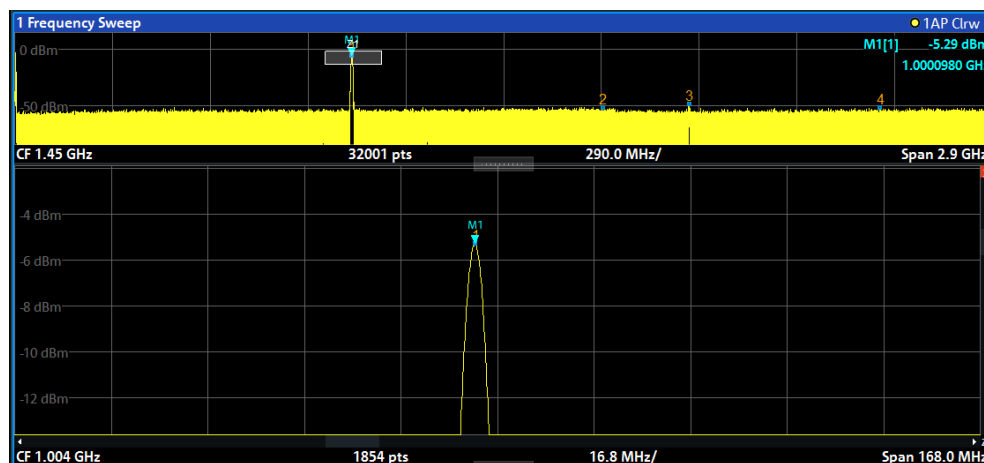

Figure 5-17: Zoomed peak with increased number of sweep points

Note that the trace becomes much more precise.



- Tap the "Multiple Zoom" icon in the toolbar again and define a zoom area around markers M2, M3 and M4.

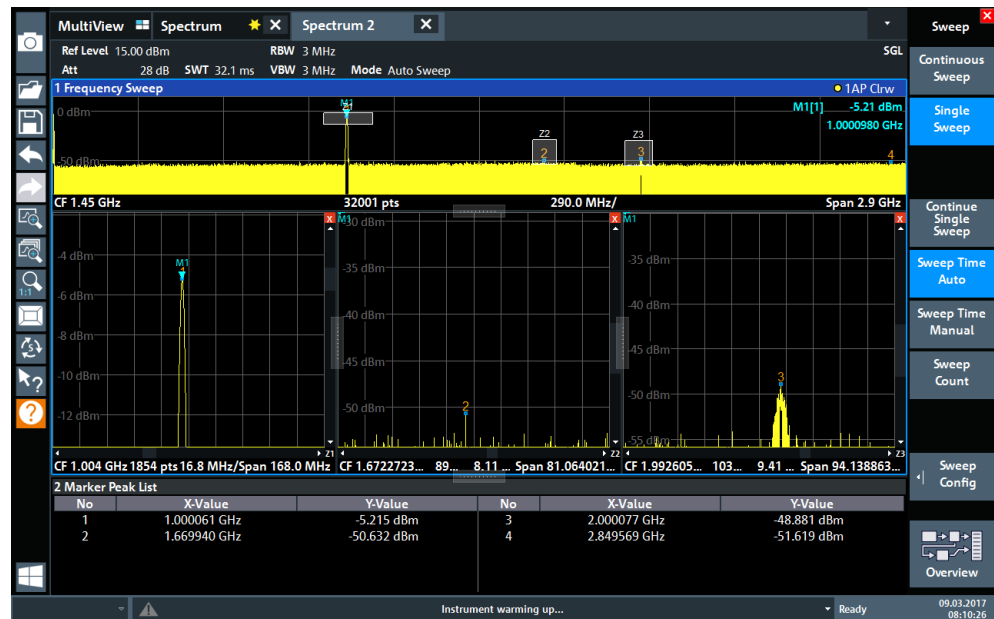
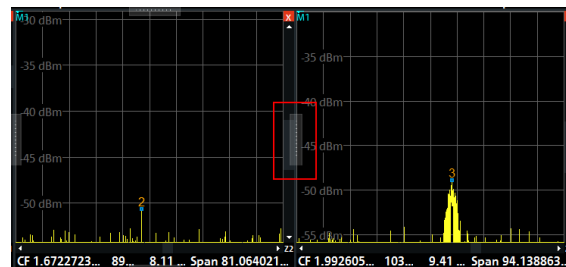

Figure 5-18: Multiple zoom windows



- Tap the "Multiple Zoom" icon in the toolbar again and define a zoom area around marker M5.
- To increase the size of the third zoom window, drag the "splitter" between the windows to the left or right or up or down.



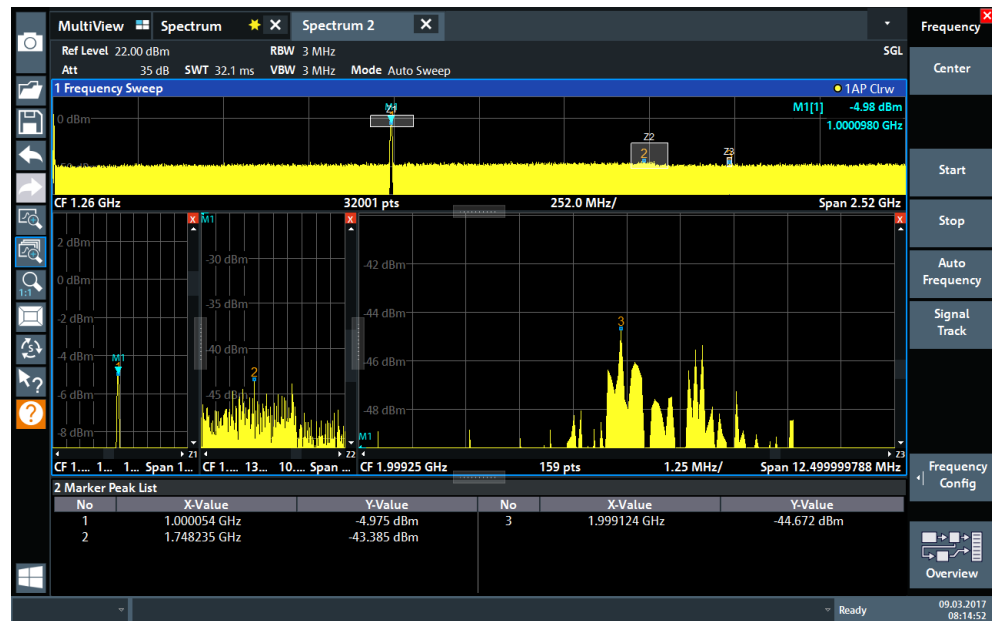

Figure 5-19: Enlarged zoom window

5.3.8 Saving Settings

To restore the results of our measurements later, we will store the instrument settings to a file.

To save the instrument settings to a file



1. Tap the "Save" icon in the toolbar.



2. Press the keyboard key on the front panel to display the online keyboard, as you will have to enter text in the next step.

3. In the "Save" dialog box, tap the "File Name" field and enter *MyMultiViewSetup* using the keyboard.

Keep the default "File Type" setting "Instrument with all Channel Setups" to store the configuration of all channel setups.

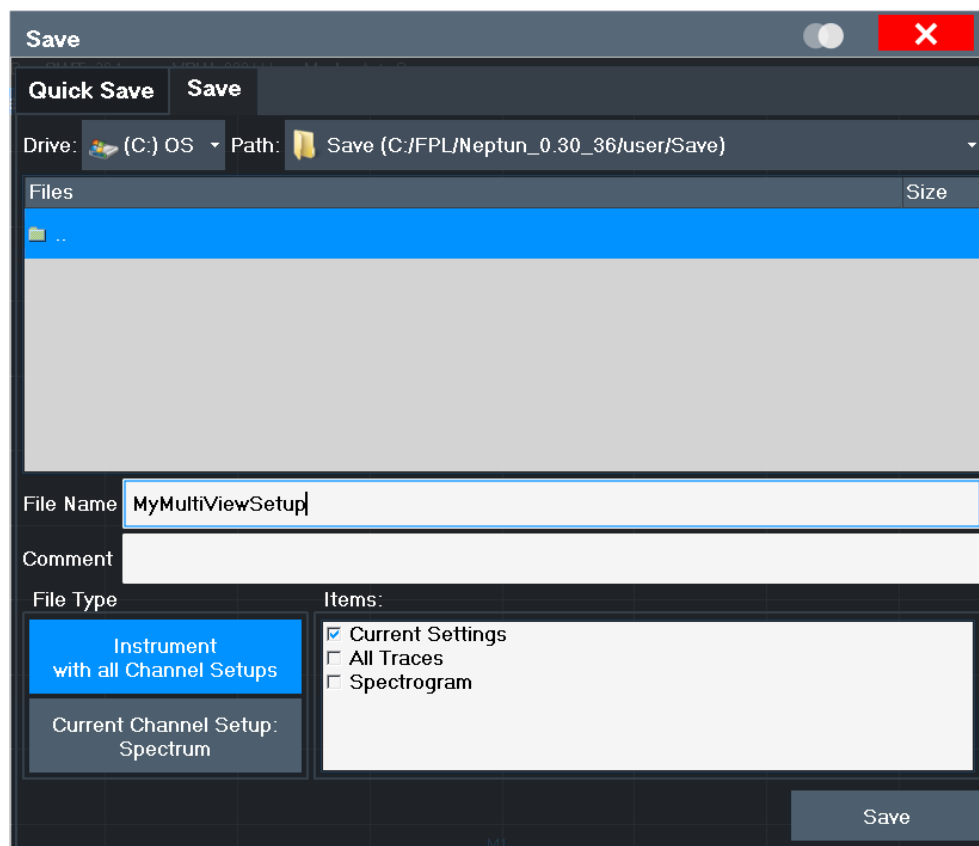

Figure 5-20: Saving the instrument settings to a file

4. Tap the "Save" button.

The file `MyMultiViewSetup.dfl` is stored in the default directory `C:\Users\Public\Documents\Rohde-Schwarz\Analyzer\user`.

To load stored instrument settings

You can restore the settings to the instrument at any time using the settings file.

1. Press the [PRESET] button to restore the default instrument settings so you can check that the stored user settings are actually restored afterwards.
2. Tap the "Load" icon in the toolbar.
3. In the "Load" dialog box, select the `MyMultiViewSetup.dfl` file in the default directory `C:\Users\Public\Documents\Rohde-Schwarz\Analyzer\user`.
4. Tap the "Load" button.



All instrument settings are restored and the display should resemble the instrument display right before the settings were stored.

5.3.9 Printing and Saving Results

Finally, after a successful measurement, we will document our results. First we will export the numeric trace data, then we will create a screenshot of the graphical display.

To export the trace data

1. Press the [TRACE] key on the front panel.
2. Tap the "Trace Config" softkey.
3. Tap the "Trace / Data Export" tab.
4. Tap the "Export Trace to ASCII File" button.
5. Enter the file name *MyMultiViewResults*.

The trace data is stored to `MyMultiViewResults.DAT`

To create a screenshot of the display



1. Tap the "Print immediately" icon in the toolbar.

A screenshot of the current display is created. Note that the colors on the screen are inverted in the screenshot to improve printout results.

2. In the "Save Hardcopy as" > "Portable Network Graphics (PNG)" dialog box, enter a file name, e.g. *MyMultiViewDisplay*.

The screenshot is stored to `MyMultiViewDisplay.png`.

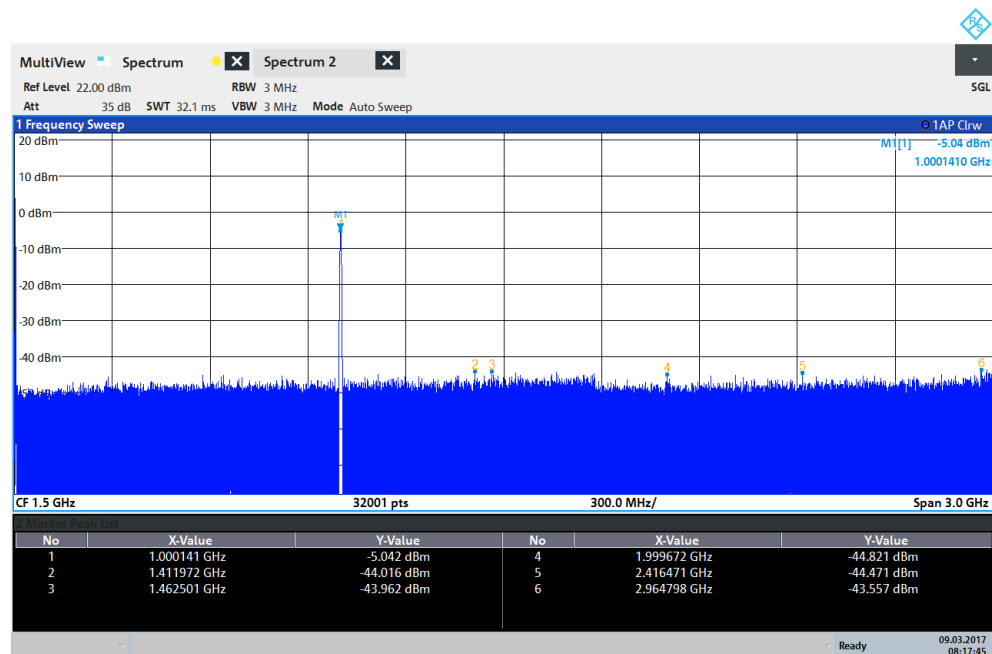

08:17:47 09.03.2017

5.4 Operating the Instrument

This chapter provides an overview on how to work with the R&S FPL1000.

NOTICE

Risk of touchscreen damage

Inappropriate tools or excessive force can damage the touchscreen.

Observe the following instructions when operating the touchscreen:

- Never touch the screen with ball point pens or other sharp objects, use your fingers instead.
As an alternative, you can use a stylus pen with a smooth soft tip.
- Never apply excessive force to the screen. Touch it gently.
- Never scratch the screen surface, for example with a finger nail.
- Never rub the screen surface strongly, for example with a dust cloth.
For instructions on cleaning the screen, see [Chapter 10.1, "Cleaning"](#), on page 961.

• Understanding the Display Information - Spectrum Mode	66
• Accessing the Functionality	74
• Entering Data	77
• Touchscreen Gestures	78
• Getting Help	81
• Remote Control	83

5.4.1 Understanding the Display Information - Spectrum Mode

The following figure shows a measurement diagram in Spectrum mode. All different information areas are labeled. They are explained in more detail in the following sections.



- 1 = Channel bar for firmware and measurement settings
- 2+3 = Window title bar with diagram-specific (trace) information
- 4 = Diagram area with marker information
- 5 = Diagram footer with diagram-specific information, depending on measurement application
- 6 = Instrument status bar with error messages and date/time display



Hiding elements in the display

You can hide some of the elements in the display, for example the status bar or channel bar, to enlarge the display area for the measurement results. ("Setup" > "Display" > "Displayed Items")

For details, see [Chapter 7.3.2, "Display Settings"](#), on page 131.

- [Channel Setup Bar](#).....67
- [Window Title Bar](#).....70
- [Marker Information](#).....71
- [Frequency and Span Information in Diagram Footer](#).....72
- [Instrument and Status Information](#).....72
- [Error Information](#).....73

5.4.1.1 Channel Setup Bar

Using the R&S FPL1000 you can handle several different measurement tasks (channels) at the same time (although they can only be performed asynchronously). For

each channel, a separate tab is displayed on the screen. To switch from one channel display to another, simply select the corresponding tab.

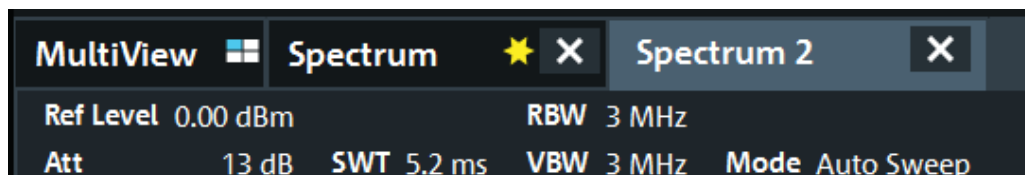

If many tabs are displayed, select the tab selection list icon at the right end of the channel bar. Select the channel you want to switch to from the list.



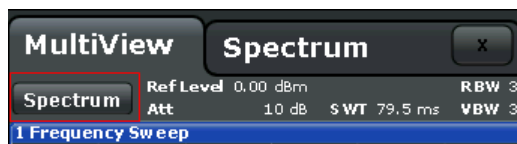

MultiView tab

An additional tab labeled "MultiView" provides an overview of all active channels at a glance. In the "MultiView" tab, each individual window contains its own channel bar with an additional button. Tap this button, or double-tap in any window, to switch to the corresponding channel display quickly.



Icons in the channel bar

The  yellow star icon on the tab label (sometimes referred to as a "dirty flag") indicates that invalid or inconsistent data is displayed, that is: the trace no longer matches the displayed instrument settings. This can happen, for example, when you change the measurement bandwidth, but the displayed trace is still based on the old bandwidth. As soon as a new measurement is performed or the display is updated, the icon disappears.

The  icon indicates that an error or warning is available for that channel setup. This is particularly useful if the MultiView tab is displayed.

The  icon indicates the currently active channel during an automatic measurement sequence (**Sequencer** functionality).

Channel-specific settings

Beneath the channel name, information on channel-specific settings for the measurement is displayed in the **channel bar**. Channel information varies depending on the active application.

In the Spectrum application, the R&S FPL1000 shows the following settings:

Table 5-5: Channel settings displayed in the channel bar in the Spectrum application

Ref Level	Reference level
Att	RF attenuation applied to input
Ref Offset	Reference level offset
SWT	Sweep time that has been set. If the sweep time does not correspond to the value for automatic coupling, a bullet is displayed in front of the field. The color of the bullet turns red if the sweep time is set below the value for automatic coupling. In addition, the UNCAL flag is shown. In this case, the sweep time must be increased. For FFT sweeps, an estimated duration for data capture <i>and processing</i> is indicated behind the sweep time in the channel bar.
RBW	Resolution bandwidth that has been set. If the bandwidth does not correspond to the value for automatic coupling, a green bullet appears in front of the field.
VBW	Video bandwidth that has been set. If the bandwidth does not correspond to the value for automatic coupling, a green bullet is displayed in front of the field.
Compatible	Compatible device mode (FSL, FSV, default; default not displayed)
Mode	Indicates which sweep mode type is used: <ul style="list-style-type: none"> • "Auto FFT" : automatically selected FFT sweep mode • "Auto sweep" : automatically selected swept sweep mode

Icons for individual settings

A bullet next to the setting indicates that user-defined settings are used, not automatic settings. A green bullet indicates this setting is valid and the measurement is correct. A red bullet indicates an invalid setting that does not provide useful results.

Common settings

The channel bar above the diagram not only displays the channel-specific settings. It also displays information on instrument settings that affect the measurement results even though it is not immediately apparent from the display of the measured values. This information is displayed in gray font and only when applicable for the current measurement, as opposed to the channel-specific settings that are always displayed.

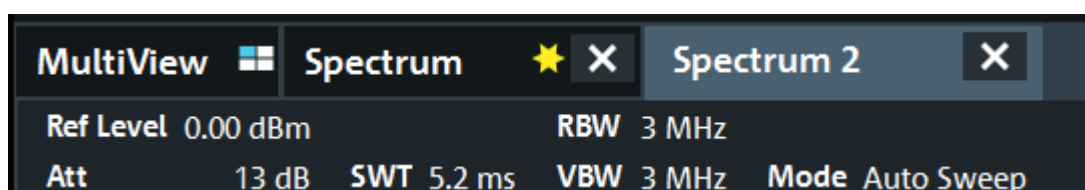

The following types of information are displayed, if applicable.

Table 5-6: Common settings displayed in the channel bar

SGL	The sweep is set to single sweep mode.
Sweep Count	The current signal count for measurement tasks that involve a specific number of subsequent sweeps (see "Sweep Count" setting in "Sweep Settings" in the User Manual)
TRG	Trigger source (for details see "Trigger settings" in the User Manual) <ul style="list-style-type: none"> • EXT: External • IFP: IF power (+trigger bandwidth) • PSE: Power sensor • TIM: Time • VID: Video
PA	The preamplifier is activated.
GAT	The frequency sweep is controlled via the "TRIGGER INPUT" connector.
TDF	A transducer factor is activated.
75 Ω	The input impedance of the instrument is set to 75 Ω.
FRQ	A frequency offset ≠ 0 Hz is set.

Changing the Channel Setup Name

The channel setups are labeled with their default name. If that name already exists, a sequential number is added. You can change the name of the channel setup by double-tapping the name in the channel bar and entering a new name.

For an overview of default names, see [INSTRUMENT:LIST?](#) on page 581.

Remote command:

[INSTRUMENT:REName](#) on page 582

5.4.1.2 Window Title Bar

Each channel in the R&S FPL1000 display can contain several windows. Each window can display either a graph or a table as a result of the channel measurement. The window title bar indicates which type of evaluation is displayed.

Which type of result evaluation is displayed in which window is defined in the display configuration (see [Chapter 8.2.2, "Basic Evaluation Methods"](#), on page 260).

Trace Information in Window Title Bar

Information on the displayed traces is indicated in the window title bar.



(1) Trace color		Color of trace display in diagram
(2) Trace no.		Trace number (1 to 6)
(3) Detector		Selected detector:
	AP	AUTOPEAK detector
	Pk	MAX PEAK detector
	Mi	MIN PEAK detector
	Sa	SAMPLE detector
	Av	AVERAGE detector
	Rm	RMS detector
(4) Trace Mode		Sweep mode:
	ClrW	CLEAR/WRITE
	Max	MAX HOLD
	Min	MIN HOLD
	Avg	AVERAGE (Lin/Log/Pwr)
	View	VIEW
(5) Smoothing factor	Smth	Smoothing factor, if enabled. (See " Smoothing " on page 512)

5.4.1.3 Marker Information

Marker information is provided either in the diagram grid or in a separate marker table, depending on the configuration.

Marker information in diagram grid

Within the diagram grid, the x-axis and y-axis positions of the last two markers or delta markers that were set are displayed, if available, as well as their index. The value in the square brackets after the index indicates the trace to which the marker is assigned. (Example: M2[1] defines marker 2 on trace 1.) For more than two markers, a separate marker table is displayed beneath the diagram by default.

Marker information in marker table

In addition to the marker information displayed within the diagram grid, a separate marker table may be displayed beneath the diagram. This table provides the following information for all active markers:

"Type"	Marker type: N (normal), D (delta), T (temporary, internal), PWR (power sensor)
"Ref"	Reference (for delta markers)
"Trc"	Trace to which the marker is assigned

"X-value"	X-value of the marker
"Y-Value"	Y-value of the marker
"Function"	Activated marker or measurement function
"Function Result"	Result of the active marker or measurement function

The functions are indicated with the following abbreviations:

"FXD"	Fixed reference marker
"Phase Noise"	Phase noise measurement
"Signal Count"	Signal count
"TRK"	Signal tracking
"Noise Meas"	Noise measurement
"MDepth"	AM modulation depth
"TOI"	Third order intercept measurement

5.4.1.4 Frequency and Span Information in Diagram Footer

The information in the diagram footer (beneath the diagram) depends on the current application, measurement, and result display.

For a default measurement in the Spectrum mode, the Diagram result display contains the following information, for example:

Label	Information
CF	Center frequency
Span	Frequency span (frequency domain display)
ms/	Time per division (time domain display)
Pts	Number of sweep points or (rounded) number of currently displayed points in zoom mode

5.4.1.5 Instrument and Status Information



Global instrument settings and functions, the instrument status and any irregularities are indicated in the status bar beneath the diagram.



In the MultiView tab, the status bar always displays the information for the currently selected measurement.

The following information is displayed:

Instrument status

	The instrument is configured for operation with an external reference.
	Battery loading status

Date and time

The date and time settings of the instrument are displayed in the status bar.



Error messages

If errors or irregularities are detected, a keyword and an error message, if available, are displayed in the status bar.

5.4.1.6 Error Information

If errors or irregularities are detected, a keyword and an error message, if available, are displayed in the status bar.



Depending on the type of message, the status message is indicated in varying colors.

Table 5-7: Status bar information - color coding

Color	Type	Description
Red	Error	An error occurred at the start or during a measurement, e.g. due to missing data or wrong settings, so that the measurement cannot be started or completed correctly.
Orange	Warning	An irregular situation occurred during measurement, e.g. the settings no longer match the displayed results, or the connection to an external device was interrupted temporarily.
Gray	Information	Information on the status of individual processing steps.
No color	No errors	No message displayed - normal operation.
Green	Measurement successful	Some applications visualize that the measurement was successful by showing a message.



If any error information is available for a channel setup, an exclamation mark is displayed next to the channel setup name (■). This is particularly useful when the Multi-View tab is displayed, as the status bar in the MultiView tab always displays the information for the currently selected channel setup only.

Furthermore, a status bit is set in the `STATUS:QUESTIONable:EXTended:INFO` register for the application concerned (see "[STATUS:QUESTIONable:EXTended:INFO Register](#)" on page 196). Messages of a specific type can be queried using the `SYST:ERR:EXT?` command, see [SYSTem:ERRor:EXTended?](#) on page 910.

The following keywords are used:

IF OVLD	Overload of the IF signal path in the A/D converter or in the digital IF. <ul style="list-style-type: none"> Increase the reference level.
INPUT OVLD	The signal level at the RF input connector exceeds the maximum. The RF input is disconnected from the input mixer to protect the device. To re-enable measurement, decrease the level at the RF input connector and reconnect the RF input to the mixer input.
NO REF	Instrument was set to an external reference but no signal was detected on the reference input.
OVEN	The optional OCXO reference frequency has not yet reached its operating temperature. The message usually disappears a few minutes after power has been switched on.
RF OVLD	Overload of the input mixer or of the analog IF path. <ul style="list-style-type: none"> Increase the RF attenuation (for RF input). Reduce the input level (for digital input)
UNCAL	One of the following conditions applies: <ul style="list-style-type: none"> Correction data has been switched off. No correction values are available, for example after a firmware update. Record the correction data by performing a self alignment (For details refer to Chapter 5.1.1.9, "Performing a Self-Alignment", on page 22).
WRONG_FW	The firmware version is out-of-date and does not support the currently installed hardware. Until the firmware version is updated, this error message is displayed and self-alignment fails. (For details refer to Chapter 7.3.4.4, "Firmware Updates" , on page 145).

5.4.2 Accessing the Functionality

All tasks necessary to operate the instrument can be performed using this user interface. Apart from instrument specific keys, all other keys that correspond to an external keyboard (e.g. arrow keys, ENTER key) operate as specified by Microsoft.

For most tasks, there are at least 2 alternative methods to perform them:

- Using the touchscreen
- Using other elements provided by the front panel, e.g. the keypad, rotary knob, or arrow and position keys.

The measurement and instrument functions and settings can be accessed by selecting one of the following elements:

- System and function keys on the front panel of the instrument
- Softkeys on the touchscreen
- Context menus for specific elements on the touchscreen
- Icons on the tool bar in the touchscreen
- Displayed setting on the touchscreen

5.4.2.1 Toolbar

Standard functions can be performed via the icons in the toolbar on the left side of the screen.



You can hide the toolbar display, e.g. when using remote control, to enlarge the display area for the measurement results ("Setup" > "Display" > "Displayed Items").

See "[Displayed Items](#)" on page 132.

For details see [Chapter 7.1, "Toolbar Functions"](#), on page 100.

5.4.2.2 Softkeys

Softkeys are virtual keys provided by the software. Thus, more functions can be provided than those that can be accessed directly via the function keys on the instrument. Softkeys are dynamic, i.e. depending on the selected function key, a different list of softkeys is displayed on the right side of the screen.

A list of softkeys for a certain function key is also called a menu. Softkeys can either perform a specific function or open a dialog box.

The "More" softkey indicates that the menu contains more softkeys than can be displayed at once on the screen. When pressed, it displays the next set of softkeys.

Recognizing the softkey status by color

Color	Meaning
Orange	Associated dialog box is open
Blue	Associated function is active; for toggle keys: currently active state
Gray	Instrument function is temporarily not available due to a specific setting or missing option



You can hide the softkey display, e.g. when using remote control, to enlarge the display area for the measurement results ("Setup" > "Display" > "Displayed Items"). See the User Manual for details.

5.4.2.3 Context Menus

Several items in the diagram area have context menus (for example markers, traces or the channel bar). If you right-click on one of these items (or tap it for about 1 second), a

menu is displayed which contains the same functions as the corresponding softkey. This is useful, for example, when the softkey display is hidden.

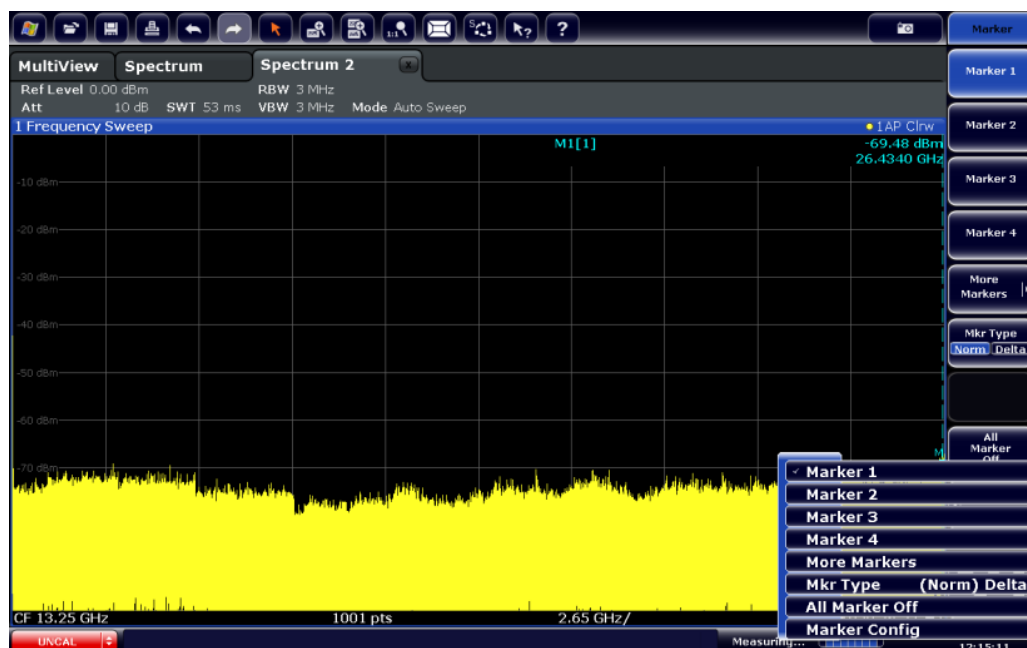

5.4.2.4 On-screen Keyboard

The on-screen keyboard is an additional means of interacting with the instrument without having to connect an external keyboard.

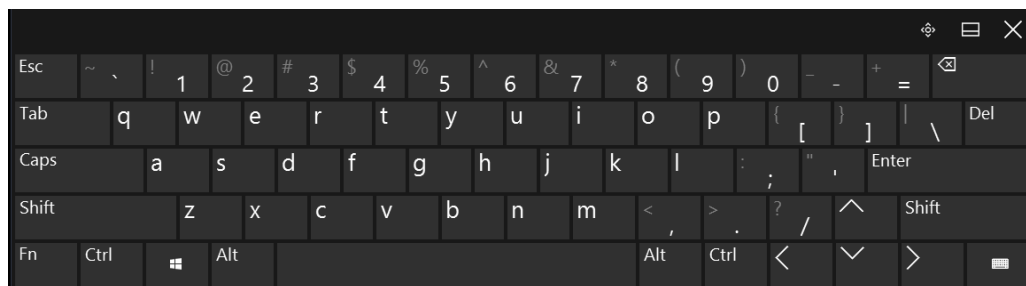

The on-screen keyboard display can be switched on and off as desired using the "On-Screen Keyboard" function key beneath the screen.



When you press this key, the display switches between the following options:

- Keyboard displayed at the top of the screen
- Keyboard displayed at the bottom of the screen
- No keyboard displayed



You can use the TAB key on the on-screen keyboard to move the focus from one field to another in dialog boxes.

5.4.3 Entering Data

Data can be entered in dialog boxes using one of the following methods:

- Using the touchscreen, via the online keyboard
- Using other elements provided by the front panel, e.g. the keypad, rotary knob, or navigation keys
The rotary knob acts like the [ENTER] key when it is pressed.
- Using a connected external keyboard



Transparent dialog boxes

You can change the transparency of the dialog boxes to see the results in the windows behind the dialog box. Thus, you can see the effects that the changes you make to the settings have on the results immediately.

To change the transparency, select the transparency icon at the top of the dialog box. A slider is displayed. To hide the slider, select the transparency icon again.



(The title bar of the dialog box is always slightly transparent and is not affected by the slider.)



Particularities in Windows dialog boxes

In some cases, e.g. if you want to install a printer, original Windows dialog boxes are used. In these dialog boxes, the rotary knob and function keys do not work. Use the touchscreen instead.

Entering Numeric Parameters

If a field requires numeric input, the keypad provides only numbers.

1. Enter the parameter value using the keypad, or change the currently used parameter value by using the rotary knob (small steps) or the [UP] or [DOWN] keys (large steps).
2. After entering the numeric value via keypad, press the corresponding unit key. The unit is added to the entry.
3. If the parameter does not require a unit, confirm the entered value by pressing the [ENTER] key or any of the unit keys. The editing line is highlighted to confirm the entry.

Entering Alphanumeric Parameters

If a field requires alphanumeric input, you can use the on-screen keyboard to enter numbers and (special) characters (see [Chapter 5.4.2.4, "On-screen Keyboard"](#), on page 76).

Correcting an entry

1. Using the arrow keys, move the cursor to the right of the entry you want to delete.
2. Press the [BACKSPACE] key.
The entry to the left of the cursor is deleted.
3. Enter your correction.

Completing the entry

- ▶ Press the [ENTER] key or the rotary knob.

Aborting the entry

- ▶ Press the [ESC] key.
The dialog box is closed without changing the settings.

5.4.4 Touchscreen Gestures

A touchscreen allows you to interact with the software using various finger gestures on the screen. The basic gestures supported by the software and most applications are described here. Further actions using the same gestures may be possible.



Tapping

Touch the screen quickly, usually on a specific element.

You can tap most elements on the screen; in particular, any elements you can also click on with a mouse pointer.

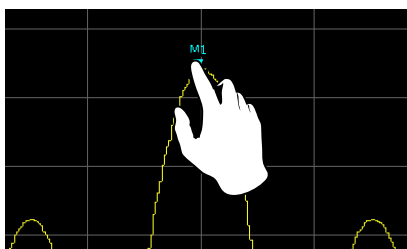
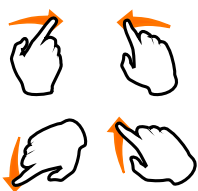

Figure 5-21: Tapping

Double-tapping

Tap the screen twice, in quick succession.

Double-tap a diagram or the window title bar to maximize a window in the display, or to restore the original size.



Dragging

Move your finger from one position to another on the display, keeping your finger on the display the whole time.

By dragging your finger over a table or diagram you can pan the displayed area of the table or diagram to show results that were previously out of view.

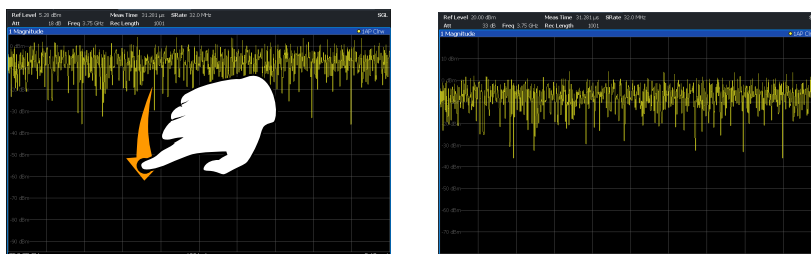
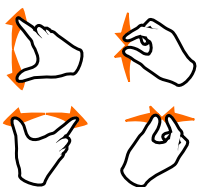

Figure 5-22: Dragging



Pinching and spreading two fingers

Move two fingers together on the display (pinch) or move two fingers apart on the display (spread).

When you pinch two fingers in the display, you decrease the size of the currently displayed area, showing the surrounding areas previously out of view.

When you spread two fingers in the display, you increase the size of the currently displayed area, showing more details.

You can pinch or spread your fingers vertically, horizontally, or diagonally. The direction in which you move your fingers determines which dimension of the display is changed.

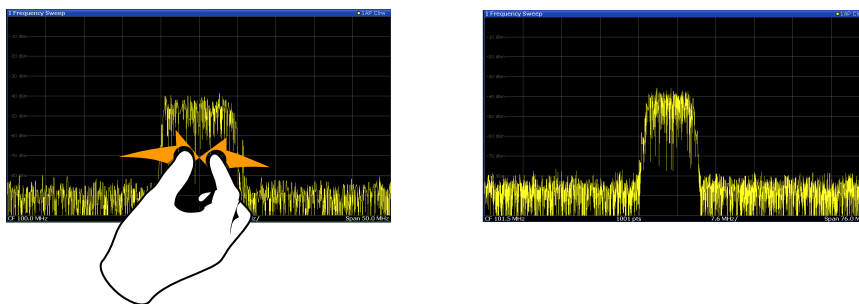

Figure 5-23: Pinching

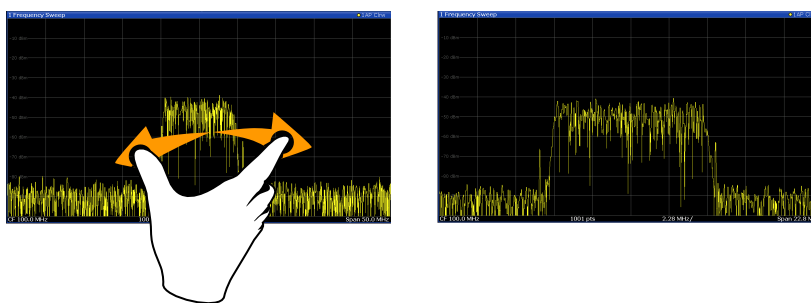

Figure 5-24: Spreading



Touch gestures in diagrams change measurement settings

When you change the display using touch gestures, the corresponding measurement settings are adapted. This is different to selecting an area on the screen in zoom mode, where merely the resolution of the displayed trace points is changed temporarily (graphical zoom).

For example:

- Dragging horizontally in a spectrum display changes the center frequency.
- Dragging vertically in a power vs frequency (spectrum) or power vs. time display changes the reference level (for absolute scaling) or the min and max power values (for relative scaling).
- Dragging horizontally in a time domain display changes the trigger offset value (if available, not in free run).
- Spreading or pinching a spectrum display changes the center frequency and span (horizontal) or reference level and range (vertical), or a combination of these settings (diagonal).
- Spreading or pinching a time domain display changes the sweep time and trigger offset (horizontal) or reference level position and range (vertical), or a combination of these settings (diagonal).

Mouse vs. touch actions

Any user interface elements that react to actions by a mouse pointer also react to finger gestures on the screen, and vice versa. The following touch actions correspond to mouse actions:

Table 5-8: Correlation of mouse and touch actions

Mouse operation	Touch operation
Click	Tap
Double-click	Double-tap
Click and hold	Touch and hold
Right-click	Touch, hold for 1 second and release
Drag-&-drop (= click and hold, then drag and release)	Touch, then drag and release

Mouse operation	Touch operation
n.a. (Change hardware settings)	Spread and pinch two fingers
Mouse wheel to scroll up or down	Swipe
Dragging scrollbars to scroll up or down, left or right	Swipe
In (graphical) Zoom mode only: dragging the borders of the displayed rectangle to change its size	Touch, then drag and release

Example:

You can scroll through a long table in conventional mouse operation by clicking in the table's scrollbar repeatedly. In touch operation, you would scroll through the table by dragging the table up and down with your finger.

5.4.5 Getting Help

If any questions or problems concerning the R&S FPL1000 arise, an extensive online help system is provided on the instrument and can be consulted at any time. The help system is context-sensitive and provides information specifically for the current operation or setting to be performed. In addition, general topics provide an overview on complete tasks or function groups as well as background information.

5.4.5.1 Calling Up Help

The online help can be opened at any time by selecting one of the "Help" icons on the toolbar or by pressing the F1 key on an external or the on-screen keyboard.

Calling context-sensitive help

- ▶ To display the "Help" dialog box for the currently focused screen element, e.g. a softkey or a setting in an opened dialog box, select the "Help" icon on the toolbar.



The "Help" dialog box "View" tab is displayed. A topic containing information about the focused screen element is displayed.

If no context-specific help topic is available, a more general topic or the "Content" tab is displayed.



For standard Windows dialog boxes (e.g. File Properties, Print dialog etc.), no context-sensitive help is available.

- ▶ To display a help topic for a screen element not currently focused:

- a) Select the "Help pointer" icon on the toolbar.



The pointer changes its shape to a "?" and an arrow.

- b) Select the screen element to change the focus.

A topic containing information about the selected (now focused) screen element is displayed.

5.4.5.2 Using the Help Window

The Help window contains several tabs:

- "View" - shows the selected help topic
- "Contents" - contains a table of help contents
- "Index" - contains index entries to search for help topics
- "Search" - provides text search



The Help toolbar provides some buttons:

- To browse the topics in the order of the table of contents: Up arrow = previous topic, Down arrow = next topic
- To browse the topics visited before: Left arrow = back, Right arrow = forward
- To increase or decrease the font



To navigate the Help, use the touchscreen. Alternatively, you can also use the navigation keys on the front panel.

To search for a topic in the index

The index is sorted alphabetically. You can browse the list, or search for entries in the list.

1. Switch to the "Index" tab.
2. Select the "Keyboard" icon besides the entry field.
3. Enter the first characters of the keyword you are interested in.
The entries containing these characters are displayed.
4. Double-tap the suitable index entry.
The "View" tab with the corresponding help topic is displayed.

To search topics for a text string

1. Switch to the "Search" tab.

2. Select the "Keyboard" icon besides the entry field.
3. Enter the string you want to find.
If you enter several strings with blanks between, topics containing all words are found (same as AND operator).

For advanced search, consider the following:

- To find a defined string of several words, enclose it in quotation marks. For example, a search for *"trigger qualification"* finds all topics with exactly *"trigger qualification"*. A search for *trigger qualification* finds all topics that contain the words *trigger* and *qualification*.
- Use "Match whole word" and "Match case" to refine the search.
- Use operators AND, OR, and NOT.

To close the Help window

- ▶ Select the "Close" icon in the upper right corner of the help window.
Or: Press the [ESC] key.

5.4.6 Remote Control

In addition to working with the R&S FPL1000 interactively, located directly at the instrument, it is also possible to operate and control it from a remote PC. Various methods for remote control are supported:

- Connecting the instrument to a (LAN) network (see [Chapter 5.1.5, "Setting Up a Network \(LAN\) Connection"](#), on page 30)
- Using the LXI browser interface in a LAN network
- Using the Windows Remote Desktop application in a LAN network
- Connecting a PC via the GPIB interface

How to configure the remote control interfaces is described in the User Manual.



The R&S FPL1000 is delivered with *IECWIN* installed, the auxiliary remote control tool provided free of charge by Rohde & Schwarz.

For details on the IECWIN tool, see the "Network and Remote Control" chapter of the R&S FPL1000 User Manual.

5.4.6.1 Using the LXI Browser Interface in a LAN

LAN eXtensions for Instrumentation (LXI) is an instrumentation platform for measuring instruments and test systems that is based on standard Ethernet technology. LXI is intended to be the LAN-based successor to GPIB, combining the advantages of Ethernet with the simplicity and familiarity of GPIB. The LXI browser interface allows for easy configuration of the LAN and remote control of the R&S FPL1000 without additional installation requirements.

For details see [Chapter 5.1.2.3, "Login"](#), on page 24

Via the LXI browser interface to the R&S FPL1000 you can control the instrument remotely from another PC. Manual instrument controls are available via the front panel simulation. File upload and download between the instrument and the remote PC is also available. Using this feature, several users can access *and operate* the R&S FPL1000 simultaneously. This is useful for troubleshooting or training purposes. If necessary, this feature can be deactivated.

For details see "[LXI Web Browser Interface](#)" on page 171.

5.4.6.2 Remote Desktop Connection

Remote Desktop is a Windows application which can be used to access and control the instrument from a remote computer through a LAN connection. While the instrument is in operation, the instrument screen contents are displayed on the remote computer. Remote Desktop provides access to all of the applications, files, and network resources of the instrument. Thus, remote operation of the instrument is possible.

The Remote Desktop Client is part of the installed Windows operating system. For other versions of Windows, Microsoft offers the Remote Desktop Client as an add-on.

5.4.6.3 Connecting a PC via the GPIB Interface

You can connect a PC to the R&S FPL1000 via the GPIB interface to send remote commands to control and operate the instrument. You can configure the GPIB address and the ID response string. The GPIB language is set as SCPI by default but can be changed to emulate other instruments.

A GPIB interface is available on the rear panel of the R&S FPL1000 if the option R&S FPL1-B10 is installed.

6 Applications, Measurement Channels, and Result Displays

The R&S FPL1000 allows you to perform all sorts of different analysis tasks on different types of signals, e.g. Analog Demodulation, I/Q analysis or basic spectrum analysis. Depending on the task or type of signal, a different set of measurement functions and parameters are required. Therefore, the R&S FPL1000 provides various applications - some of which are included in the base unit, others are optional.

The default application when you start the R&S FPL1000 is "Spectrum" , for basic spectrum analysis measurements on any type of signal.

Channel Setups

When you activate an application, a new channel setup is created which determines the measurement settings for that application. The same application can be activated with different measurement settings by creating several channel setups for the same application.

The number of channel setups that can be configured at the same time depends on the available memory on the instrument.

For more information on creating channel setups, see [Chapter 6.3, "Defining Channel Setups"](#), on page 87.

• Available Applications	85
• R&S MultiView	86
• Defining Channel Setups	87
• Running a Sequence of Measurements	89
• Channel Setup Overview	93
• Configuring Result Displays	94

6.1 Available Applications

Access: [MODE]

The R&S FPL1000 provides some applications in the base unit while others are available only if the corresponding firmware options are installed.

Each application is described in a separate manual.



Spectrograms

Spectrogram measurements are not a separate application, but rather a trace evaluation method in the R&S FPL1000, thus they are available as an evaluation method in the "Display Config" , not by creating a new channel setup. Spectrograms are configured and activated in the "Trace" settings.

See [Chapter 8.10.2.1, "Working with Spectrograms"](#), on page 515 for details.

Spectrum	86
I/Q Analyzer	86
Analog Demod	86
Noise Figure	86

Spectrum

In the Spectrum application the provided functions correspond to those of a conventional spectrum analyzer. The analyzer measures the frequency spectrum of the RF input signal over the selected frequency range with the selected resolution and sweep time. Alternatively, it displays the waveform of the video signal for a fixed frequency.

This is the default application of the spectrum analyzer.

Remote command:

INST:SEL SAN, see [INSTrument\[:SElect\]](#) on page 583

I/Q Analyzer

The I/Q Analyzer application provides measurement and display functions for I/Q data.

Remote command:

INST:SEL IQ, see [INSTrument\[:SElect\]](#) on page 583

Analog Demod

The Analog Demodulation application provides measurement functions for demodulating AM, FM, or PM signals.

This application requires the optional firmware R&S FPL1-K7 to be installed.

For details see the Analog Demodulation Mode User Manual.

Remote command:

INST:SEL ADEM, see [INSTrument\[:SElect\]](#) on page 583

Noise Figure

The Noise Figure application provides noise figure measurements.

This application requires the optional firmware R&S FPL1-K30 to be installed.

For details see the Noise Figure Measurements User Manual.

Remote command:

INST:SEL NOISE, see [INSTrument\[:SElect\]](#) on page 583

6.2 R&S MultiView

Each application is displayed in a separate tab. If more than one application is active, an additional tab ("MultiView") provides an overview of all currently active channel setups at a glance. In the "MultiView" tab, each individual window contains its own channel setup bar. Select the channel setup bar to switch to an application quickly.

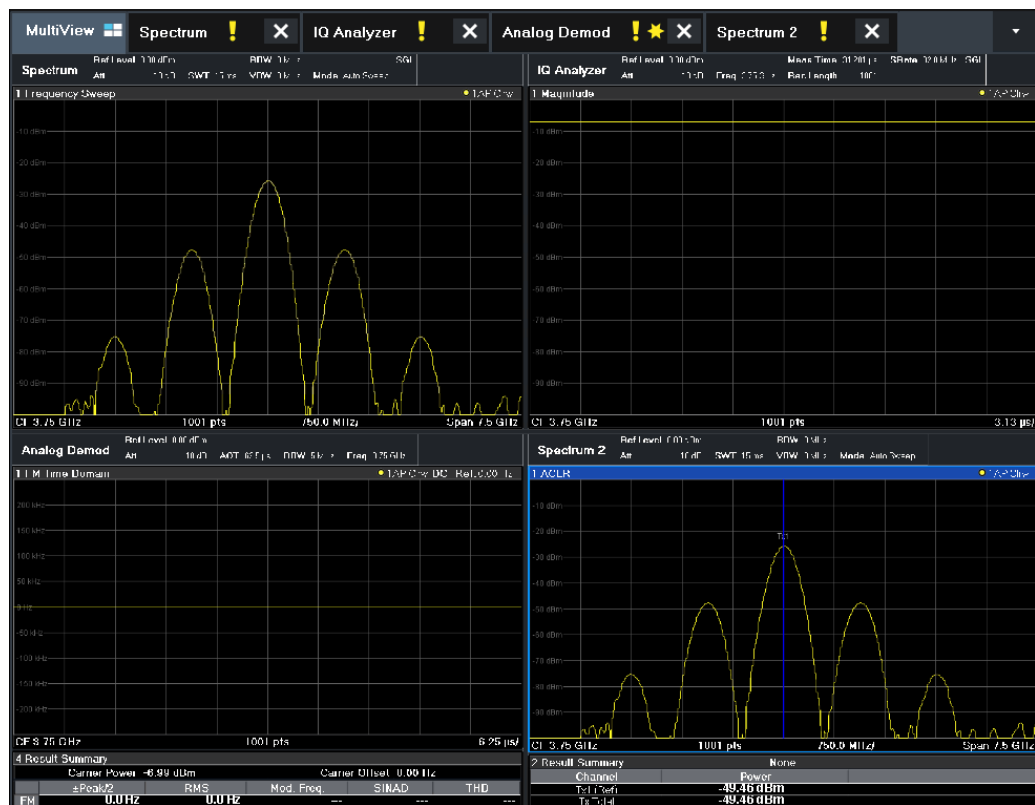

6.3 Defining Channel Setups

Access: [MODE]

The default channel setup uses the "Spectrum" application.

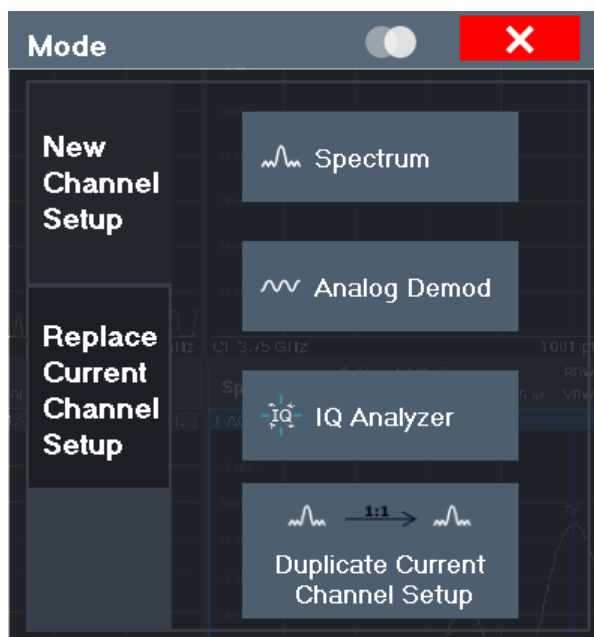

Switching between channel setups

When you switch to a new channel setup, a set of parameters is passed on from the current channel setup to the new one:

- Center frequency and frequency offset
- Reference level and reference level offset
- Attenuation

After initial setup, the parameters for the channel setup are stored upon exiting and restored upon re-entering the channel setup. Thus, you can switch between measurements quickly and easily.

Defining a channel setup.....	88
L New Channel Setup	89
L Replace Current Channel Setup	89
L Duplicate Current Channel	89
Closing a channel setup.....	89

Defining a channel setup

To start a new channel setup or replace an existing one, select the corresponding application in the "Mode" dialog box.

Note: The channel setups are labeled with the application name. If that name already exists, a sequential number is added. You can change the name of the channel setup by double-tapping the name in the channel setup bar and entering a new name. For an overview of default names see [INSTRUMENT:LIST?](#) on page 581.

Remote command:

[INSTRUMENT\[:SElect\]](#) on page 583

New Channel Setup ← Defining a channel setup

The application selected on this tab of the dialog box activates a new channel setup, i.e. a new tab in the display.

Note: The channel setups are labeled with the application name. If that name already exists, a sequential number is added. You can change the name of the channel setup by double-tapping the name in the channel setup bar and entering a new name. For an overview of default names see [INSTrument:LIST?](#) on page 581.

Remote command:

[INSTrument:CREate\[:NEW\]](#) on page 580

[INSTrument\[:SElect\]](#) on page 583

Replace Current Channel Setup ← Defining a channel setup

The application selected on this tab of the dialog box is started in the currently displayed channel setup, replacing the current measurement.

Remote command:

[INSTrument:CREate:REPLace](#) on page 581

Duplicate Current Channel ← Defining a channel setup

The currently active channel setup can be duplicated, i.e. a new channel setup of the same type and with the identical measurement settings is started. The name of the new channel setup is the same as the copied channel setup, extended by a consecutive number (e.g. "Spectrum" -> "Spectrum 2").

Remote command:

[INSTrument:CREate:DUPLicate](#) on page 580

Closing a channel setup

To close a channel setup, simply close the corresponding tab by selecting the "x" next to the channel setup name.

Remote command:

[INSTrument:DELeTe](#) on page 581

6.4 Running a Sequence of Measurements

Only one measurement can be performed at any time, namely the one in the currently active channel setup. However, in order to perform the configured measurements consecutively, a Sequencer function is provided.

- [The Sequencer Concept](#)..... 89
- [Sequencer Settings](#).....92
- [How to Set Up the Sequencer](#).....92

6.4.1 The Sequencer Concept

The instrument can only activate one specific channel setup at any time. Thus, only one measurement can be performed at any time, namely the one in the currently active channel setup. However, in order to perform the configured measurements consecutively,

tively, a Sequencer function is provided, which changes the channel setup of the instrument as required. If activated, the measurements configured in the currently defined "Channel" s are performed one after the other in the order of the tabs.

For each individual measurement, the sweep count is considered. Thus, each measurement may consist of several sweeps. The currently active measurement is indicated by a  symbol in the tab label.

The result displays of the individual channel setups are updated in the tabs as the measurements are performed. Sequential operation itself is independent of the currently *displayed* tab.

Sequencer modes

Three different Sequencer modes are available:

- **Single Sequence**
Similar to single sweep mode; each measurement is performed once, until all measurements in all defined "Channel" s have been performed.
- **Continuous Sequence**
Similar to continuous sweep mode; the measurements in each defined "Channel" are performed one after the other, repeatedly, in the same order, until sequential operation is stopped. This is the default Sequencer mode.
- **Channel-defined Sequence**
First, a single sequence is performed. Then, only "Channel" s in continuous sweep mode are repeated continuously.

Example: Sequencer procedure

Assume the following active channel setup definition:



Tab name	Application	Sweep mode	Sweep count
Spectrum	Spectrum	Cont. Sweep	5
Spectrum 2	Spectrum	Single Sweep	6
Spectrum 3	Spectrum	Cont. Sweep	2
IQ Analyzer	IQ Analyzer	Single Sweep	7

For **Single Sequence**, the following sweeps will be performed:

5x Spectrum, 6x Spectrum 2, 2 x Spectrum 3, 7x IQ Analyzer

For **Continuous Sequence**, the following sweeps will be performed:

5x Spectrum, 6x Spectrum 2, 2 x Spectrum 3, 7x IQ Analyzer,

5x Spectrum, 6x Spectrum 2, 2 x Spectrum 3, 7x IQ Analyzer,

...

For **Channel-defined Sequence**, the following sweeps will be performed:

5x Spectrum, 6x Spectrum 2, 2 x Spectrum 3, 7x IQ Analyzer,

5x Spectrum, 2 x Spectrum 3,

5x Spectrum, 2 x Spectrum 3,

...

RUN SINGLE/RUN CONT and Single Sweep/Sweep Continuous keys

While the Sequencer is active, the [RUN SINGLE] and [RUN CONT] keys control the Sequencer, not individual sweeps. [RUN SINGLE] starts the Sequencer in single mode, while [RUN CONT] starts the Sequencer in continuous mode.

The "Single Sweep" and "Continuous Sweep" *softkeys* control the sweep mode for the currently selected channel setup only; the sweep mode only has an effect the next time the Sequencer activates that channel setup, and only for a channel-defined sequence. In this case, a channel setup in single sweep mode is swept only once by the Sequencer. A channel setup in continuous sweep mode is swept repeatedly.

6.4.2 Sequencer Settings



The "Sequencer" menu is available from the toolbar.

Sequencer State	92
Sequencer Mode	92

Sequencer State

Activates or deactivates the Sequencer. If activated, sequential operation according to the selected Sequencer mode is started immediately.

Remote command:

`SYSTEM:SEQuencer` on page 585

`INITiate:SEQuencer:IMMediate` on page 584

`INITiate:SEQuencer:ABORt` on page 583

Sequencer Mode

Defines how often which measurements are performed. The currently selected mode softkey is highlighted blue. During an active Sequencer process, the selected mode softkey is highlighted orange.

"Single Sequence"

Each measurement is performed once, until all measurements in all active channel setups have been performed.

"Continuous Sequence"

The measurements in each active channel setup are performed one after the other, repeatedly, in the same order, until sequential operation is stopped.

This is the default Sequencer mode.

"Channel Defined Sequence"

First, a single sequence is performed. Then, only channel setups in continuous sweep mode are repeated.

Remote command:

`INITiate:SEQuencer:MODE` on page 584

6.4.3 How to Set Up the Sequencer

In order to perform the configured measurements consecutively, a Sequencer function is provided.

1. Configure a channel setup for each measurement configuration as required, including the sweep mode.

- In the toolbar, select the "Sequencer" icon.



The "Sequencer" menu is displayed.

- Toggle the "Sequencer" softkey to "On" .

A continuous sequence is started immediately.

- To change the Sequencer mode and start a new sequence immediately, select the corresponding mode softkey, or press the [RUN SINGLE] or [RUN CONT] key.

The measurements configured in the currently active channel setups are performed one after the other in the order of the tabs until the Sequencer is stopped. The result displays in the individual channel setups are updated as the measurements are performed.

To stop the Sequencer

- ▶ To stop the Sequencer temporarily, press the highlighted [RUN SINGLE] or [RUN CONT] key (not for a channel-defined sequence). To continue the Sequencer, press the key again.

To stop the Sequencer permanently, select the "Sequencer" icon in the toolbar and toggle the "Sequencer" softkey to "Off" .

6.5 Channel Setup Overview

Each channel setup provides an overview of the most important currently defined settings and access to the most important configuration dialog boxes for the particular measurement.

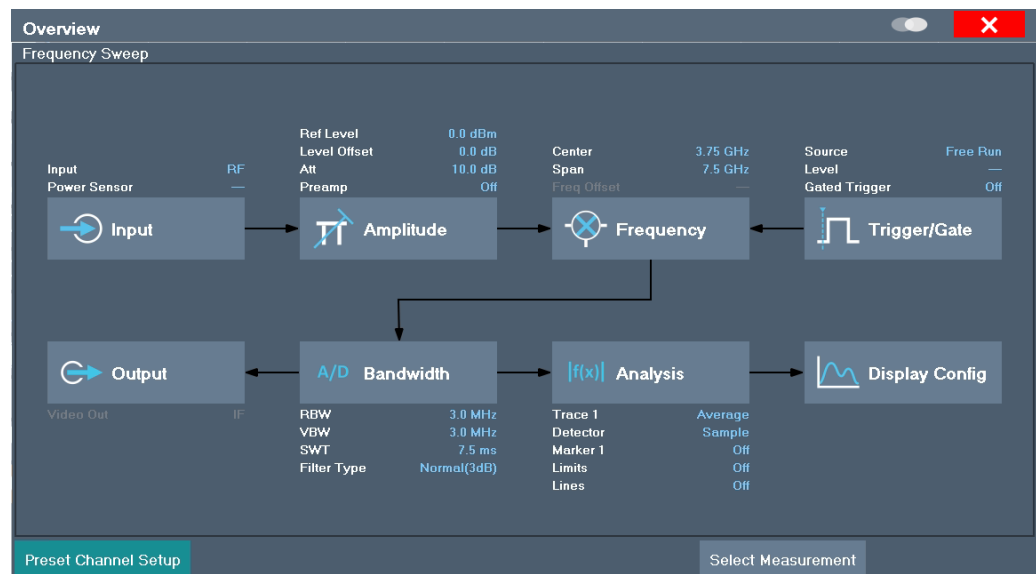

Using this overview, you can easily configure an entire channel setup from input over processing to output and analysis by stepping through the dialog boxes as indicated.

See [Chapter 8, "The Spectrum Application \(RF Measurements\)"](#), on page 237 for details on configuration.

6.6 Configuring Result Displays

Measurement results can be evaluated in many different ways, for example graphically, as summary tables, statistical evaluations etc. Thus, the result display is highly configurable to suit your specific requirements and optimize analysis. Here you can find out how to optimize the display for your measurement results.

General display settings that are usually configured during initial instrument setup, independently of the current measurement, e.g. which items or colors are displayed on the screen, are described in [Chapter 7.3.2.1, "Display Settings"](#), on page 131.

- [Laying out the Result Display with the SmartGrid](#).....94
- [Changing the Size of Windows](#)..... 98

6.6.1 Laying out the Result Display with the SmartGrid

Measurement results can be evaluated in many different ways, for example graphically, as summary tables, statistical evaluations etc. Each type of evaluation is displayed in a separate window in the channel setup tab. Up to 16 individual windows can be displayed per channel setup (i.e. per tab). To arrange the diagrams and tables on the screen, the Rohde & Schwarz SmartGrid function helps you find the target position simply and quickly.

(For details on evaluation methods see [Chapter 8.2.2, "Basic Evaluation Methods"](#), on page 260.)

Principally, the layout of the windows on the screen is based on an underlying grid, the SmartGrid. However, the SmartGrid is dynamic and flexible, allowing for many different layout possibilities. The SmartGrid functionality provides the following basic features:

- Windows can be arranged in columns or in rows, or in a combination of both.
- Windows can be arranged in up to four rows and four columns.
- Windows are moved simply by dragging them to a new position on the screen, possibly changing the layout of the other windows, as well.
- All evaluation methods available for the currently selected measurement are displayed as icons in the evaluation bar. If the evaluation bar contains more icons than can be displayed at once on the screen, it can be scrolled vertically. The same evaluation method can be displayed in multiple windows simultaneously.
- New windows are added by dragging an evaluation icon from the evaluation bar to the screen. The position of each new window depends on where you drop the evaluation icon in relation to the existing windows.
- All display configuration actions are only possible in SmartGrid mode. When SmartGrid mode is activated, the evaluation bar replaces the current softkey menu dis-

play. When the SmartGrid mode is deactivated again, the previous softkey menu display is restored.

- [Background Information: The SmartGrid Principle](#).....95
- [How to Activate SmartGrid Mode](#).....96
- [How to Add a New Result Window](#).....97
- [How to Close a Result Window](#).....97
- [How to Arrange the Result Windows](#).....97

6.6.1.1 Background Information: The SmartGrid Principle

SmartGrid display

During any positioning action, the underlying SmartGrid is displayed. Different colors and frames indicate the possible new positions. The position in the SmartGrid where you drop the window determines its position on the screen.

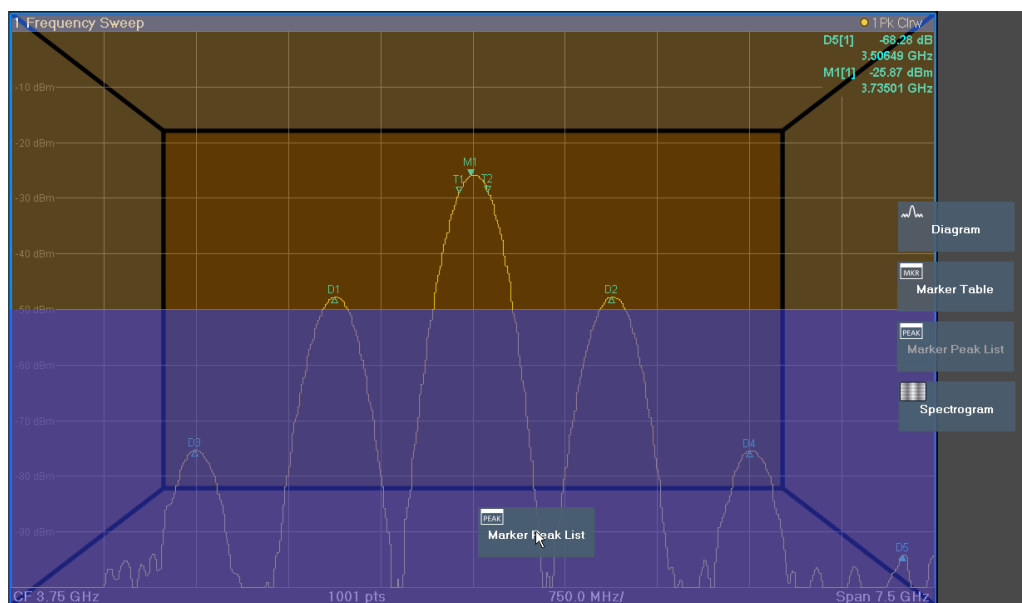

Figure 6-1: Moving a window in SmartGrid mode

The brown area indicates the possible "drop area" for the window, i.e. the area in which the window can be placed. A blue area indicates the (approximate) layout of the window as it would be if the icon were dropped at the current position. The frames indicate the possible destinations of the new window with respect to the existing windows: above/below, right/left or replacement (as illustrated in Figure 6-2). If an existing window would be replaced, the drop area is highlighted in a darker color shade.

Positioning the window

The screen can be divided into up to four rows. Each row can be split into up to four columns, where each row can have a different number of columns. However, rows always span the entire width of the screen and may not be interrupted by a column. A single row is available as the drop area for the window in the SmartGrid. The row can

be split into columns, or a new row can be inserted above or below the existing row (if the maximum of 4 has not yet been reached).

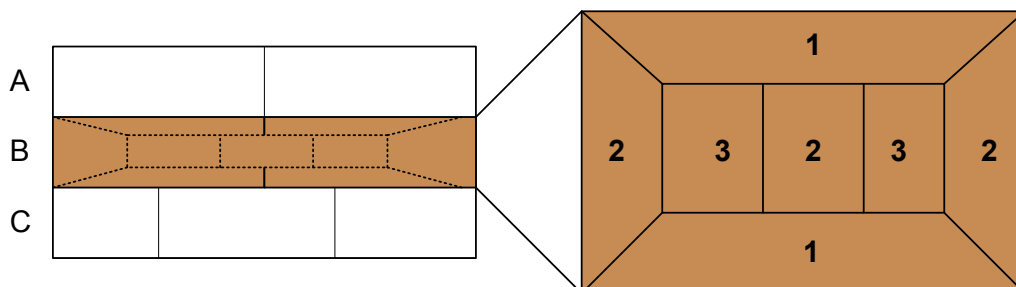

Figure 6-2: SmartGrid window positions

- 1 = Insert row above or below the existing row
- 2 = Create a new column in the existing row
- 3 = Replace a window in the existing row

SmartGrid functions

Once the evaluation icon has been dropped, icons in each window provide delete and move functions.



The "Move" icon allows you to move the position of the window, possibly changing the size and position of the other displayed windows.



The "Delete" icon allows you to close the window, enlarging the display of the remaining windows.

6.6.1.2 How to Activate SmartGrid Mode

All display configuration actions are only possible in SmartGrid mode. In SmartGrid mode the evaluation bar replaces the current softkey menu display. When the SmartGrid mode is deactivated again, the previous softkey menu display is restored.

- ▶ To activate SmartGrid mode, do one of the following:



- Select the "SmartGrid" icon from the toolbar.
- Select the "Display Config" button in the configuration "Overview" .
- Select the "Display Config" softkey from the [MEAS CONFIG] menu.

The SmartGrid functions and the evaluation bar are displayed.



To close the SmartGrid mode and restore the previous softkey menu select the "Close" icon in the right-hand corner of the toolbar, or press any key.

6.6.1.3 How to Add a New Result Window

Each type of evaluation is displayed in a separate window. Up to 16 individual windows can be displayed per channel setup (i.e. per tab).

1. Activate SmartGrid mode.
All evaluation methods available for the currently selected measurement are displayed as icons in the evaluation bar.
2. Select the icon for the required evaluation method from the evaluation bar.
If the evaluation bar contains more icons than can be displayed at once on the screen, it can be scrolled vertically. Touch the evaluation bar between the icons and move it up or down until the required icon appears.
3. Drag the required icon from the evaluation bar to the SmartGrid, which is displayed in the diagram area, and drop it at the required position. (See [Chapter 6.6.1.5, "How to Arrange the Result Windows"](#), on page 97 for more information on positioning the window).

Remote command:

`LAYout:ADD[:WINDow]?` on page 703 / `LAYout:WINDow<n>:ADD?` on page 707

6.6.1.4 How to Close a Result Window

- ▶ To close a window, activate SmartGrid mode and select the "Delete" icon for the window.



Remote command:

`LAYout:REMove[:WINDow]` on page 705 / `LAYout:WINDow<n>:REMove` on page 708

6.6.1.5 How to Arrange the Result Windows

1. Select an icon from the evaluation bar or the "Move" icon for an existing evaluation window.



2. Drag the evaluation over the SmartGrid.

A blue area shows where the window will be placed.

3. Move the window until a suitable area is indicated in blue.
4. Drop the window in the target area.

The windows are rearranged to the selected layout, and "Delete" and "Move" icons are displayed in each window.

5. To close a window, select the corresponding "Delete" icon.



Remote command:

`LAYout:REPLace[:WINDow]` on page 706 / `LAYout:WINDow<n>:REPLace` on page 708

6.6.2 Changing the Size of Windows

Each channel setup tab may contain several windows to evaluate the measurement results using different methods. A "splitter" allows you to change the size of neighboring windows.

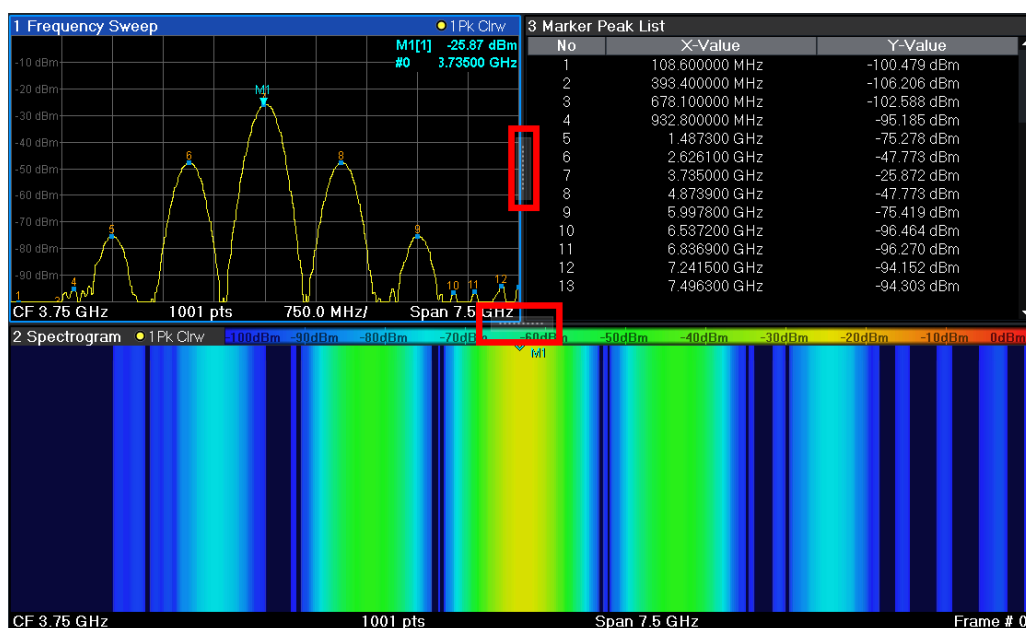

The splitters are not available in SmartGrid mode.

- ▶ To change the size of two neighboring windows, drag the splitter between the windows in either direction.

7 Common Instrument Functions

Some settings and functions are available throughout the instrument, regardless of the currently active application. These settings and functions are described here, and are not repeated for each application.

- [Toolbar Functions](#)..... 100
- [Data Management](#).....101
- [General Instrument Setup](#)..... 130
- [Network and Remote Operation](#).....167

7.1 Toolbar Functions

Standard functions can be performed via the icons in the toolbar at the top of the screen.



You can hide the toolbar display, e.g. when using remote control, to enlarge the display area for the measurement results ("Setup" > "Display" > "Displayed Items"). See "[Displayed Items](#)" on page 132.

Windows	100
Open	100
Store	100
Print immediately	100
Undo	101
Redo	101
Zoom mode	101
Multiple zoom mode	101
Zoom off	101
SmartGrid	101
Sequencer	101
Help (+ Select)	101
Help	101



Windows

Displays the Windows "Start" menu and task bar.

See [Chapter 5.1.2.4, "Accessing the Start Menu"](#), on page 26



Open

Opens a file from the instrument ("Save/Recall" menu)



Store

Stores data on the instrument ("Save/Recall" menu)



Print immediately

Prints the current display (screenshot) as configured

**Undo**

Reverts last operation, i.e. the status before the previous action is retrieved.

The undo function is useful, for example, if you are performing a zero span measurement with several markers and a limit line defined and accidentally select a different measurement. In this case, many settings would be lost. However, if you press [UNDO] immediately afterwards, the previous status is retrieved, i.e. the zero span measurement and all settings.

Note: The [UNDO] function is not available after a [PRESET] or "Recall" operation. When these functions are used, the history of previous actions is deleted.

**Redo**

Repeats previously reverted operation

**Zoom mode**

Displays a dotted rectangle in the diagram that can be expanded to define the zoom area

**Multiple zoom mode**

Multiple zoom areas can be defined for the same diagram

**Zoom off**

Displays the diagram in its original size

**SmartGrid**

Activates "SmartGrid" mode to configure the screen layout

**Sequencer**

Opens the "Sequencer" menu to perform consecutive measurements

**Help (+ Select)**

Allows you to select an object for which context-specific help is displayed

See [Chapter 5.4.5, "Getting Help"](#), on page 81

**Help**

Displays context-sensitive help topic for the most recently selected element

See [Chapter 5.4.5, "Getting Help"](#), on page 81

7.2 Data Management

The R&S FPL1000 allows you to save and recall measurement settings. Measurement data can be exported and imported for a later analysis, the graphical result display can be stored to a file or printed. In addition, various application-specific data can be saved and/or recalled.

General storage and import/export functions are available via the toolbar. Some special storage functions are (also) available via softkeys or dialog boxes in the corresponding menus, for example trace data export.

- [Restoring the Default Instrument Configuration \(Preset\).....](#) 102
- [Storing and Recalling Instrument Settings and Measurement Data.....](#) 102
- [Import/Export Functions.....](#) 113
- [Creating Screenshots of Current Measurement Results and Settings.....](#) 115

7.2.1 Restoring the Default Instrument Configuration (Preset)

When delivered, the R&S FPL1000 has a default configuration. You can restore this defined initial state at any time as a known starting point for measurements. This is often recommendable as a first step in troubleshooting when unusual measurement results arise.



Factory default configuration

The factory default configuration is selected such that the RF input is always protected against overload, provided that the applied signal levels are in the allowed range for the instrument.

Alternatively to the factory default settings, you can define user-specific recall settings to be restored after a preset or reboot, see "[To recall settings automatically after preset or reboot](#)" on page 112.

To restore the default instrument configuration for all channel setups at once

- ▶ Press the [PRESET] key.



After you use the [PRESET] function, the history of previous actions is deleted, i.e. any actions performed previously cannot be undone or redone using the [UNDO/REDO] keys.

Remote command:

*RST or SYSTem:PRESet

To restore the default configuration for a single channel setup

The default measurement settings can also be reset for an individual channel setup only, rather than resetting the entire instrument.

- ▶ In the "Overview" , select the "Preset Channel" button.

The factory default settings are restored to the current channel setup. Note that a user-defined recall settings file is **NOT** restored.

Remote command:

SYSTem:PRESet:CHANnel [:EXEC] on page 876

7.2.2 Storing and Recalling Instrument Settings and Measurement Data



Access: "Save" / "Open" icon in the toolbar



Or: [FILE]

Possibly you would like to restore or repeat a measurement you performed under specific conditions on the instrument. Or you want to evaluate imported data in another application on the R&S FPL1000 and would like to restore the measurement settings applied during measurement. In these cases, you can store and recall instrument and measurement settings, and possibly other related measurement data.

Two different methods are available for managing instrument settings:

- Quick Save/Quick Recall - a defined set of instrument settings or channel setups are stored or recalled quickly in just one step
- Configurable Save/Recall - a user-defined set of instrument settings or channel setups are stored to a definable storage location



Restrictions when recalling measurement settings

When recalling a saved configuration file, the following restrictions apply:

- The R&S FPL1000 must support the frequency range defined in the configuration file.
 - Configuration files created on a R&S FPL1000 with certain options in use do not work on an R&S FPL1000 without these options.
 - Files created with newer firmware versions may not work with a previous version.
 - Files created on an instrument other than the R&S FPL1000 do not work on the R&S FPL1000.
-



Saving and recalling transducer and limit line settings

If a transducer file was in use when the save set was stored (with the save item "Current Settings" only) the R&S FPL1000 assumes that these transducer values should remain valid after every recall of that save set. Thus, even if the transducer file is changed and the original save set file is recalled later, the *originally stored* transducer values are recalled and applied to the measurement. In the "Edit" transducer dialog box, however, the *changed* transducer file values are displayed, as no updated transducer file was loaded.

The same applies to limit line settings.

The same applies to integrated measurements' weighting filter.

If you want to apply the changed transducer values after recalling the save set, you must force the application to reload the transducer file. To do so, simply open the "Edit Transducer" dialog box (see [Chapter 7.3.6.2, "Transducer Settings"](#), on page 154) and toggle the "X-Axis" option from "Lin" to "log" and back. Due to that change, the transducer file is automatically reloaded, and the changed transducer values are applied to the current measurement. Now you can create a new save set with the updated transducer values.

Similarly, if you want to apply the changed limit values after recalling the save set, you must force the application to reload the limit file. To do so, simply open the "Edit Limit Line" dialog box (see [Chapter 8.11.2.2, "Limit Line Settings and Functions"](#), on page 542) and toggle the "Y-Axis" unit. Due to that change, the limit line file is automatically reloaded, and the changed limit values are applied to the current measurement. Now a new save set with the updated limit values can be created.

- [Quick Save/Quick Recall](#)..... 104
- [Configurable Storage and Recall](#)..... 106
- [How to Save and Load Instrument Settings](#)..... 111

7.2.2.1 Quick Save/Quick Recall

The Quick Save and Quick Recall functions allow you to store instrument settings or channel setups very easily and quickly in one step. Up to ten different sets of settings can be stored to or recalled from "save sets". Each save set is identified by its storage date and type (instrument or specific "Channel") in the display. The save sets are stored in the

C:\Users\Public\Documents\Rohde-Schwarz\Analyzer\user\QuickSave directory, in files named QuickSave1.dfl to QuickSave10.dfl. The storage file-names and locations cannot be changed. Only the current measurement settings are stored, not any additional data such as traces, limit line or transducer files (see ["Stored Data Types"](#) on page 106).

During recall, save sets of type "Instrument" replace the settings of the entire instrument. All other save sets start a new channel setup with the stored settings.



If a channel setup with the same name as the "Channel" to be restored is already active, the name for the new channel setup is extended by a consecutive number:



Quick Save / Quick Recall Settings



Access: "Save" / "Open" icon in the toolbar > "Quick Save" / "Quick Recall"



Both dialog boxes are very similar and closely related.

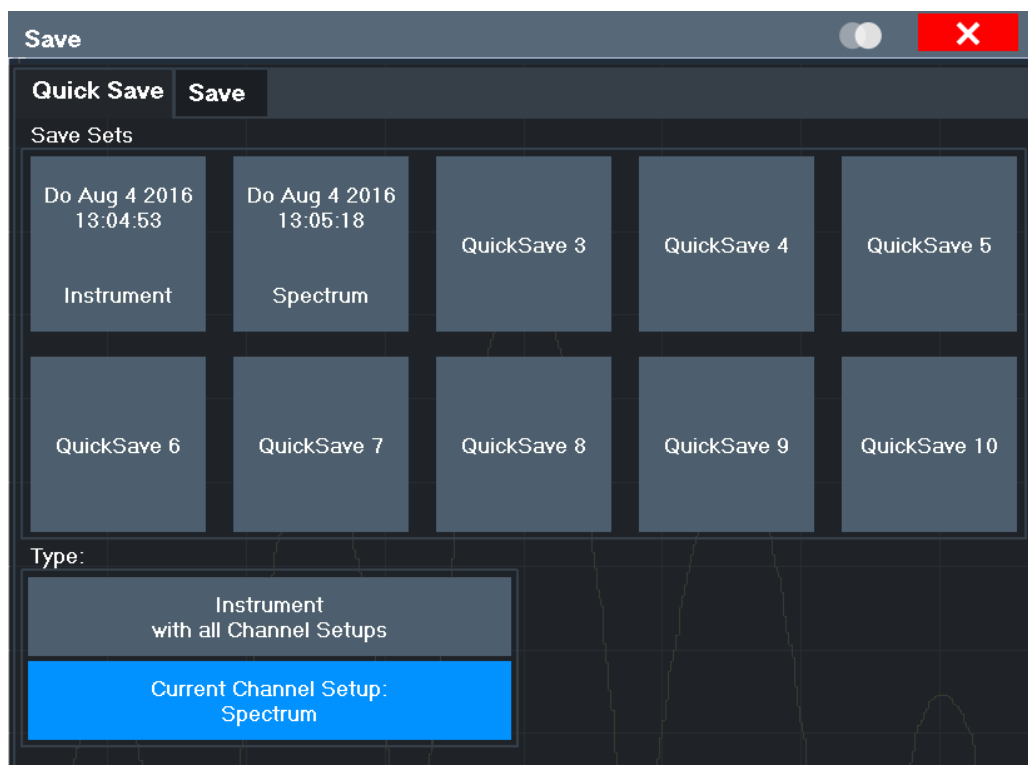

QuickSave 1 / ... / QuickSave 10 105
 Storage Type (Save only) 105
 Recall 106

QuickSave 1 / ... / QuickSave 10

Selects one of the save sets to store the current settings in or to be recalled. At the time of storage, the "QuickSave 1 / ... / QuickSave 10" placeholder is replaced by a label indicating the storage date and time and the storage type.

During recall, save sets of type "Instrument" replace the settings of the entire instrument. All other save sets start a new channel setup with the stored settings.

Storage Type (Save only)

Defines which type of settings are stored in the save set.

"Instrument with all Channels" The instrument settings for all currently active "Channel" s are stored.

"Current Channel" Only the instrument settings for the currently selected measurement "Channel" s are stored.

Recall

Restores the instrument settings as saved in the selected settings file. If the settings file contains settings for a specific "Channel" only, a new channel setup with the stored settings is activated, otherwise all "Channel" s and instrument settings are overwritten with the stored settings.

Note: After you use the "Recall" function, the history of previous actions is deleted, i.e. any actions performed previously cannot be undone or redone using the [UNDO/REDO] keys.

Remote command:

[MMEMoRy:LOAD:STATe](#) on page 873

7.2.2.2 Configurable Storage and Recall

The more sophisticated storage and recall functions allow you to define which settings are stored, and where the settings file is stored to. Any settings file can be selected for recall.

- [Stored Data Types](#)..... 106
- [Storage Location and Filename](#)..... 107
- [Save and Recall Dialog Boxes](#)..... 107
- [Startup Recall Settings](#)..... 109

Stored Data Types

The following types of data can be stored to and loaded from files via the "Save" dialog box on the R&S FPL1000:

Table 7-1: Items that can be stored to files

Item	Description
Current Settings	Current instrument and measurement settings.
All Transducers	All transducer factor <i>files</i> . (Note: Restoring a saveset overwrites transducer factor files on the hard disk that have the same name as those in the saveset. For more information, see "Saving and recalling transducer and limit line settings" on page 104.)
All Traces	All active traces.
All Limit Lines	All limit line <i>files</i> .
Spectrograms	Spectrogram trace data (only available if spectrogram display is currently active).

Storage Location and Filename

The data is stored on the internal flash disk or, if selected, on a memory stick or network drive. The operating system, firmware and stored instrument settings are located on drive C.

The storage location and filename are selected in a file selection dialog box which is displayed when you perform a storage function.

By default, the name of a settings file consists of a base name followed by an underscore and three numbers, e.g. `limit_lines_005`. In the example, the base name is `limit_lines`. The base name can contain characters, numbers and underscores. The file extension `df1` is added automatically. The default folder for settings files is `C:\Users\Public\Documents\Rohde-Schwarz\Analyzer\user`.



File name restrictions

File names must be compatible with the Windows conventions for file names. In particular, they must not contain special characters such as ":", "*", "?".

Save and Recall Dialog Boxes



Access: "Save" / "Open" icon in the toolbar > "Save" / "Recall"



Both dialog boxes are very similar and closely related.

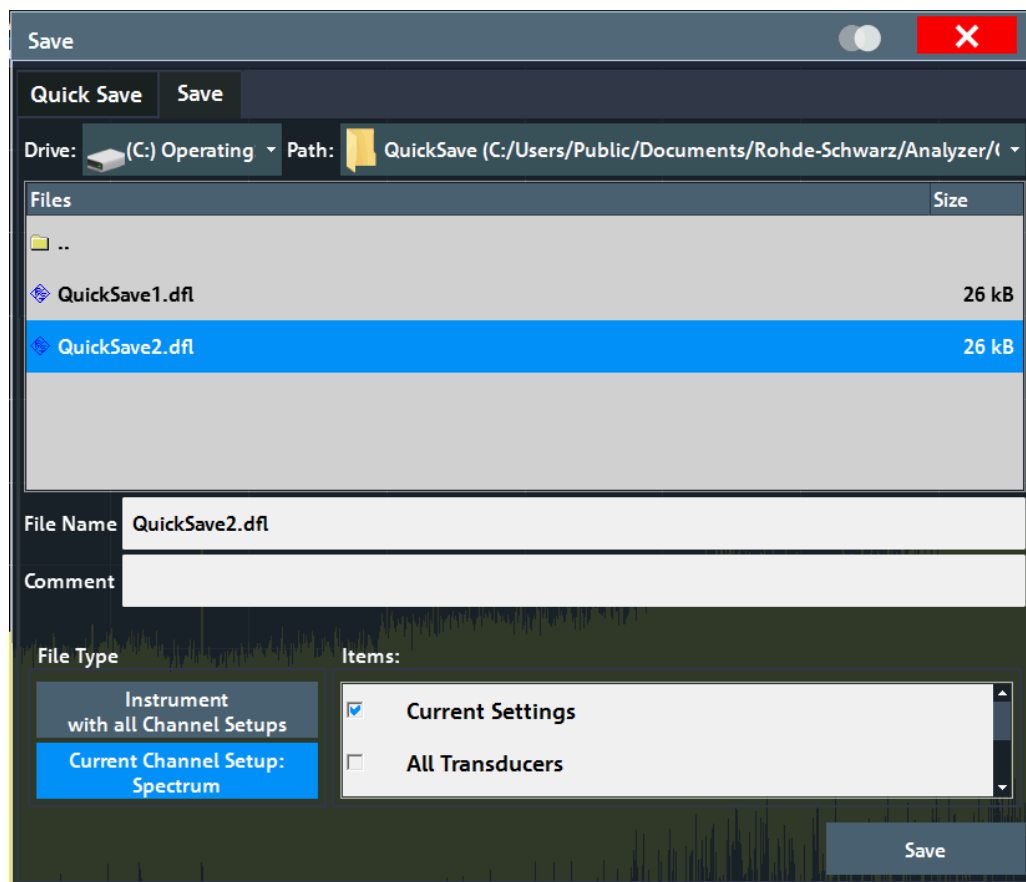

Selecting Storage Location - Drive/ Path/ Files.....	108
File Name	108
Comment	108
File Type	108
Items:	108
Save File	109
Recall in New Channel / Recall in Current Channel	109

Selecting Storage Location - Drive/ Path/ Files

Select the storage location of the file on the instrument or an external drive.

The default storage location for the SEM settings files is:

C:\ProgramData\Rohde-Schwarz\ZNL-FPL\sem_std.

Remote command:

[MMEMoRY:CATalog](#) on page 863

File Name

Contains the name of the data file without the path or extension.

By default, the name of a user file consists of a base name followed by an underscore.

Multiple files with the same base name are extended by three numbers, e.g.

limit_lines_005.

File names must be compatible with the Windows conventions for file names. In particular, they must not contain special characters such as ":", "*", "?".

For details on the filename and location, see "[Storage Location and Filename](#)" on page 107.

Comment

An optional description for the data file. A maximum of 60 characters can be displayed.

Remote command:

[MMEMoRY:COMMeNt](#) on page 864

File Type

Determines whether the global instrument settings with all "Channel" s are stored or recalled, or the current "Channel" settings only.

Items:

Defines which data and settings are stored or are recalled. Depending on the "File Type" , either channel setups only, or global settings are available. Which items are available also depends on the installed options (see also "[Stored Data Types](#)" on page 106).

Remote command:

[MMEMoRY:SELEct \[: ITEM \] :ALL](#) on page 869

[MMEMoRY:SELEct \[: ITEM \] :DEFault](#) on page 869

[MMEMoRY:SELEct \[: ITEM \] :NONE](#) on page 870

[MMEMoRY:SELEct \[: ITEM \] :HWSettings](#) on page 869

[MMEMoRY:SELEct \[: ITEM \] :LINes :ALL](#) on page 870

[MMEMoRY:SELEct \[: ITEM \] :SGRam](#) on page 870

[MMEMory:SElect\[:ITEM\]:TRACe<t>\[:ACTive\]](#) on page 871

[MMEMory:SElect\[:ITEM\]:TRANsducer:ALL](#) on page 871

Save File

Saves the settings file with the defined filename.

Remote command:

[MMEMory:STORe<n>:STATe](#) on page 874

[MMEMory:STORe<n>:STATe:NEXT](#) on page 875

Recall in New Channel / Recall in Current Channel

Restores the instrument settings as saved in the selected settings file. If the settings file contains settings for a specific "Channel" only, select "Recall in New Channel" to activate a new channel setup with the stored settings. Select "Recall in Current Channel" to replace the current "Channel" settings.

Note: After you use the "Recall" function, the history of previous actions is deleted, i.e. any actions performed previously cannot be undone or redone using the [UNDO/REDO] keys.

Remote command:

[MMEMory:LOAD:STATe](#) on page 873

Startup Recall Settings



Access: "Open" icon in the toolbar > "Startup Recall"

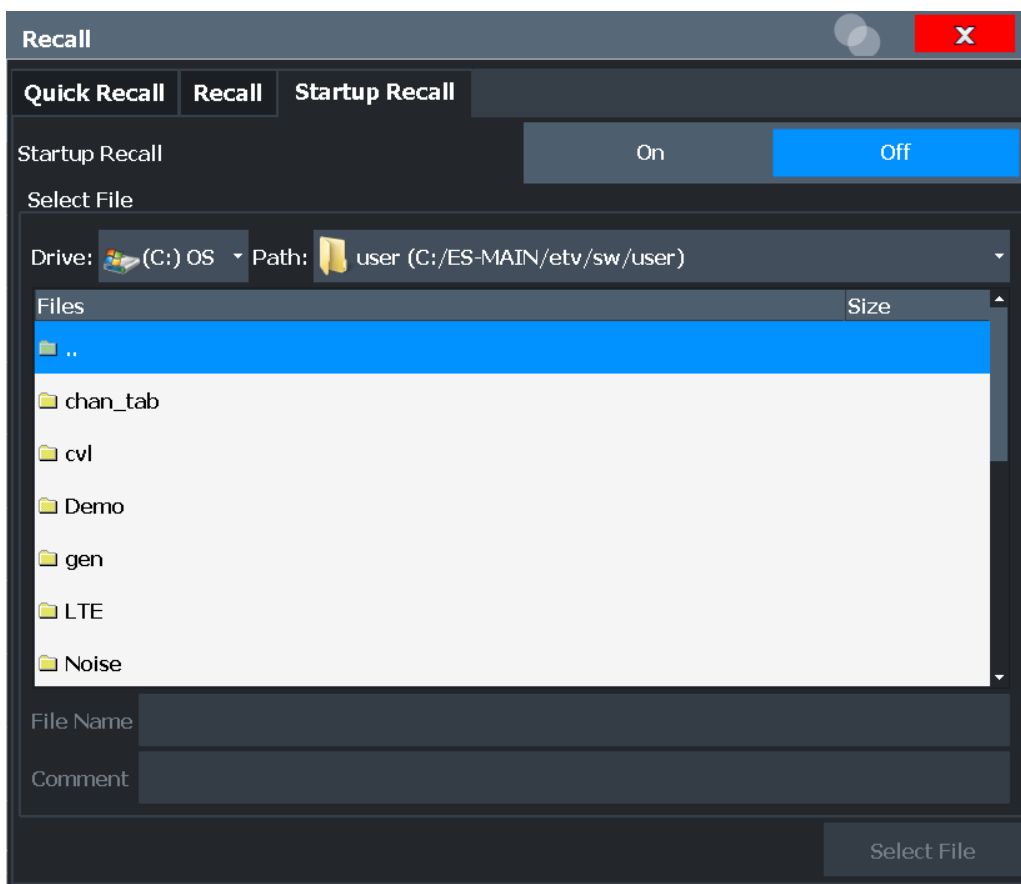

Startup Recall 110
 Selecting Storage Location - Drive/ Path/ Files..... 110
 File Name 111
 Comment 111

Startup Recall

Activates or deactivates the startup recall function. If activated, the settings stored in the selected file are loaded each time the instrument is started or preset. If deactivated, the default settings are loaded.

Note that only *instrument* settings files can be selected for the startup recall function, not "Channel" files.

Remote command:

[MMEMoRY:LOAD:AUTO](#) on page 872

Selecting Storage Location - Drive/ Path/ Files

Select the storage location of the file on the instrument or an external drive.

The default storage location for the SEM settings files is:

C:\ProgramData\Rohde-Schwarz\ZNL-FPL\sem_std.

Remote command:

[MMEMoRY:CATalog](#) on page 863

File Name

Contains the name of the data file without the path or extension.

By default, the name of a user file consists of a base name followed by an underscore. Multiple files with the same base name are extended by three numbers, e.g. `limit_lines_005`.

File names must be compatible with the Windows conventions for file names. In particular, they must not contain special characters such as ":", "*", "?".

For details on the filename and location, see ["Storage Location and Filename"](#) on page 107.

Comment

An optional description for the data file. A maximum of 60 characters can be displayed.

Remote command:

`MMEMoRY:COMMeNt` on page 864

7.2.2.3 How to Save and Load Instrument Settings

Instrument settings can be saved to a file and loaded again later, so that you can repeat the measurement with the same settings. Optionally, user-defined measurement settings can automatically be restored each time you start or preset the instrument.

To save and recall instrument settings using the Quick Save function

1. Select the "Save" icon from the toolbar.
2. Select whether the instrument settings for **all** "Channel" s are stored, or only those for the **current** "Channel" .
3. Select one of the save sets in which the settings are stored ("QuickSaveX").

The selected settings are stored to the file

`C:\Users\Public\Documents\Rohde-Schwarz\Analyzer\userQuickSave\QuickSaveX.dfl`.

Note: If you make any changes to the settings *after* storing the configuration file, remember to save the settings again. Otherwise those settings cannot be restored and will be overwritten by the stored values when the configuration file is recalled.



4. To restore the settings, select the "Open" icon from the toolbar.
5. Select the save set in which the settings were stored ("QuickSaveX").
The selected settings are restored to the instrument or channel setup.

To save configurable instrument settings

1. Select the "Save" icon from the toolbar.
2. In the "Save" dialog box, switch to the "Save" tab.

3. In the file selection dialog box, select a filename and storage location for the settings file.
4. Optionally, define a comment to describe the stored settings.
5. Select whether the instrument settings for **all** "Channel" s are stored, or only those for the **current** "Channel" .
6. Select the items to be saved with the settings. Either the settings for the currently selected "Channel" only, or the settings for all "Channel" s can be stored. Various other items, such as lines or traces etc., can be stored as well (see "[Stored Data Types](#)" on page 106).
7. Select "Save" .

A file with the defined name and path and the extension `.df1` is created.



If you make any changes to the settings *after* storing the configuration file, remember to save the settings again. Otherwise those settings cannot be restored and will be overwritten by the stored values when the configuration file is recalled.

To recall configurable instrument settings



1. Select the "Open" icon from the toolbar.
2. In the "Recall" dialog box, switch to the "Recall" tab.
3. In the file selection dialog box, select the filename and storage location of the settings file.
Note: The "File Type" indicates whether the file contains instrument settings for **all** "Channel" s, or only those for the current "Channel" .
4. If several items were saved, select which items are restored.
5. If a "Channel" was saved, select whether the settings will replace the settings in the current "Channel" , or whether a new channel setup with the saved settings will be opened.
6. Select "Recall" .

The settings and selected items from the saved measurement are restored and you can repeat the measurement with the same settings.

Note that any changes made to the settings *after* storing the configuration file will be overwritten by the stored values when the configuration file is recalled.

To recall settings automatically after preset or reboot

You can define the settings that are restored when you preset or reboot the instrument.

1. Configure the settings as required and save them as described in "[To save configurable instrument settings](#)" on page 111.
2. In the "Save/Recall" menu, select "Startup Recall" .

3. From the file selection dialog box, select the recall settings to restore.
4. Select "Select File" .
5. Set "Startup Recall" to "On" .
Now when you press the [PRESET] key or reboot the instrument, the defined settings will be restored.
6. To restore the factory preset settings, set "Startup Recall" to "Off" .

7.2.3 Import/Export Functions



Access: "Save" / "Open" icon in the toolbar > "Import" / "Export"



The R&S FPL1000 provides various evaluation methods for the results of the performed measurements. However, you may want to evaluate the data with further, external applications. In this case, you can export the measurement data to a standard format file (ASCII or XML). Some of the data stored in these formats can also be re-imported to the R&S FPL1000 for further evaluation later, for example in other applications.

The following data types can be exported (depending on the application):

- Trace data
- Table results, such as result summaries, marker peak lists etc.
- I/Q data



I/Q data can only be imported and exported in applications that process I/Q data, such as the I/Q Analyzer or optional applications.

See the corresponding user manuals for those applications for details.



These functions are only available if no measurement is running.

In particular, if [Continuous Sweep / Run Cont](#) is active, the import/export functions are not available.

Import	113
Export	114
L Export Trace to ASCII File	114
L File Type	115
L Decimal Separator	115
L Trace Export Configuration	115
L I/Q Export	115



Import
Access: "Save/Recall" > Import



Provides functions to import data.

Importing trace data is only available via the "Trace Config" dialog box, see [Chapter 8.13.2, "Trace/Data Ex/Import"](#), on page 563. I/Q data can only be imported by applications that process I/Q data.

See the R&S FPL1000 I/Q Analyzer User Manual for more information.



Export

Access: "Save/Recall" > Export



Opens a submenu to configure data export.

Export Trace to ASCII File ← Export

Saves the selected trace or all traces in the currently active result display to the specified file and directory in the selected ASCII format.

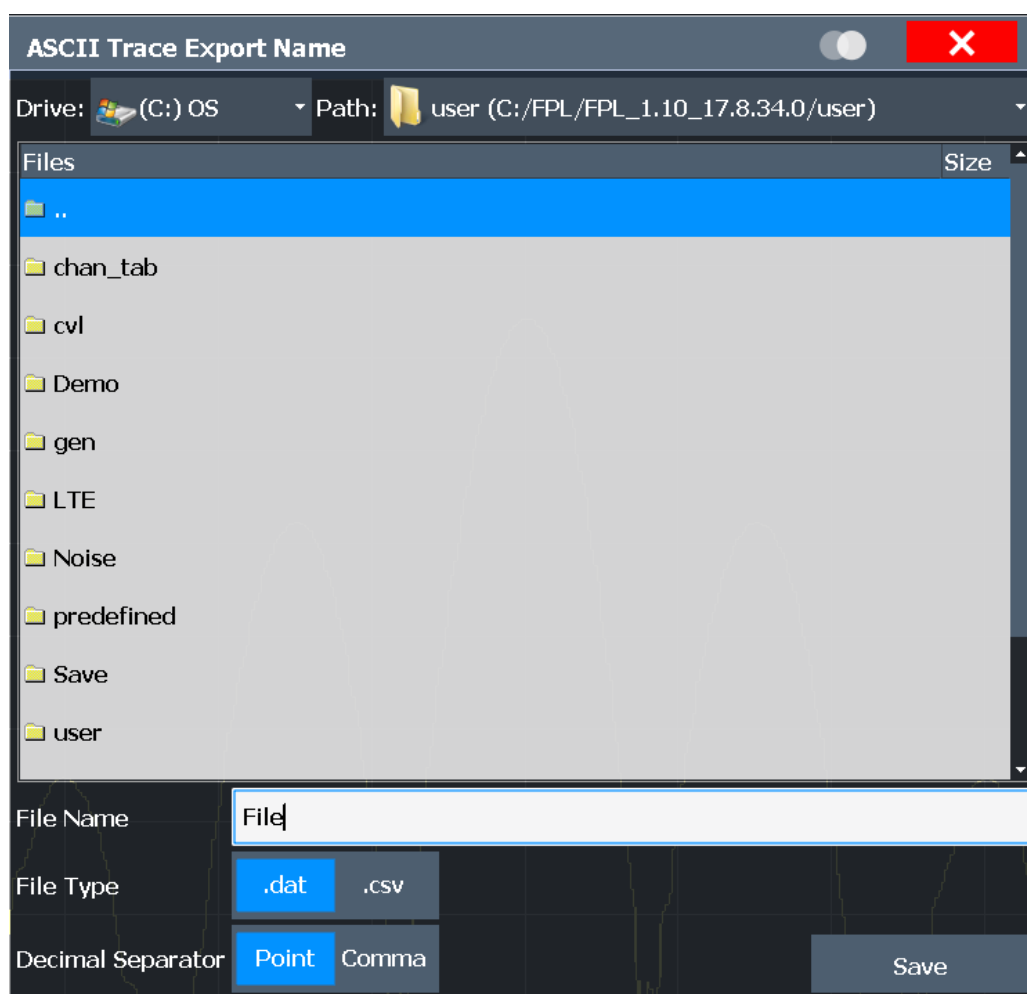

If the spectrogram display is selected when you perform this function, the entire histogram buffer with all frames is exported to a file. The data for a particular frame begins with information about the frame number and the time that frame was recorded. For large history buffers the export operation can take some time.

For details on the file format in the Spectrum application, see [Chapter 8.13.6, "Reference: ASCII File Export Format"](#), on page 568.

Remote command:

[MMEMory:STORe<n>:TRACe](#) on page 781

[MMEMory:STORe<n>:SPECTrogram](#) on page 887

File Type ← Export Trace to ASCII File ← Export

Determines the format of the ASCII file to be imported or exported.

Depending on the external program in which the data file was created or is evaluated, a comma-separated list (CSV) or a plain data format (DAT) file is required.

Remote command:

[FORMat:DEXPort:FORMat](#) on page 779

Decimal Separator ← Export Trace to ASCII File ← Export

Defines the decimal separator for floating-point numerals for the data export/import files. Evaluation programs require different separators in different languages.

Remote command:

[FORMat:DEXPort:DSEPARATOR](#) on page 863

Trace Export Configuration ← Export

Opens the "Traces" dialog box to configure the trace and data export settings.

I/Q Export ← Export

Opens a file selection dialog box to define an export file name to which the I/Q data is stored. This function is only available in single sweep mode.

It is not available in the Spectrum application, only in applications that process I/Q data, such as the I/Q Analyzer or optional applications.

For details, see the description in the R&S FPL1000 I/Q Analyzer User Manual ("Importing and Exporting I/Q Data").

Note: Storing large amounts of I/Q data (several Gigabytes) can exceed the available (internal) storage space on the R&S FPL1000. In this case, it can be necessary to use an external storage medium.

7.2.4 Creating Screenshots of Current Measurement Results and Settings

To document the graphical results and the most important settings for the currently performed measurement, you can create a screenshot of the current display. Screenshots can either be printed or stored to a file.

- [Print and Screenshot Settings](#)..... 115
- [How to Store or Print Screenshots of the Display](#)..... 125
- [Example for Storing Multiple Measurement Results to a PDF File](#)..... 128

7.2.4.1 Print and Screenshot Settings

Access: [Print]

For step-by-step instructions, see [Chapter 7.2.4.2, "How to Store or Print Screenshots of the Display"](#), on page 125.

Remote commands for these settings are described in [Chapter 9.9.4, "Storing or Printing Screenshots"](#), on page 876.



To print a screenshot of the current display with the current settings immediately, without switching to the "Print" menu, use the "Print immediately" icon in the toolbar.

- [Print Content Settings](#)..... 116
- [Print Preview Functions](#)..... 119
- [Printer Settings](#)..... 120
- [Page Setup](#)..... 123
- [Print Color Settings](#)..... 124

Print Content Settings



Access: "Print" > "Print Config" > "Content" tab

The content settings determine which data is included in the printout.

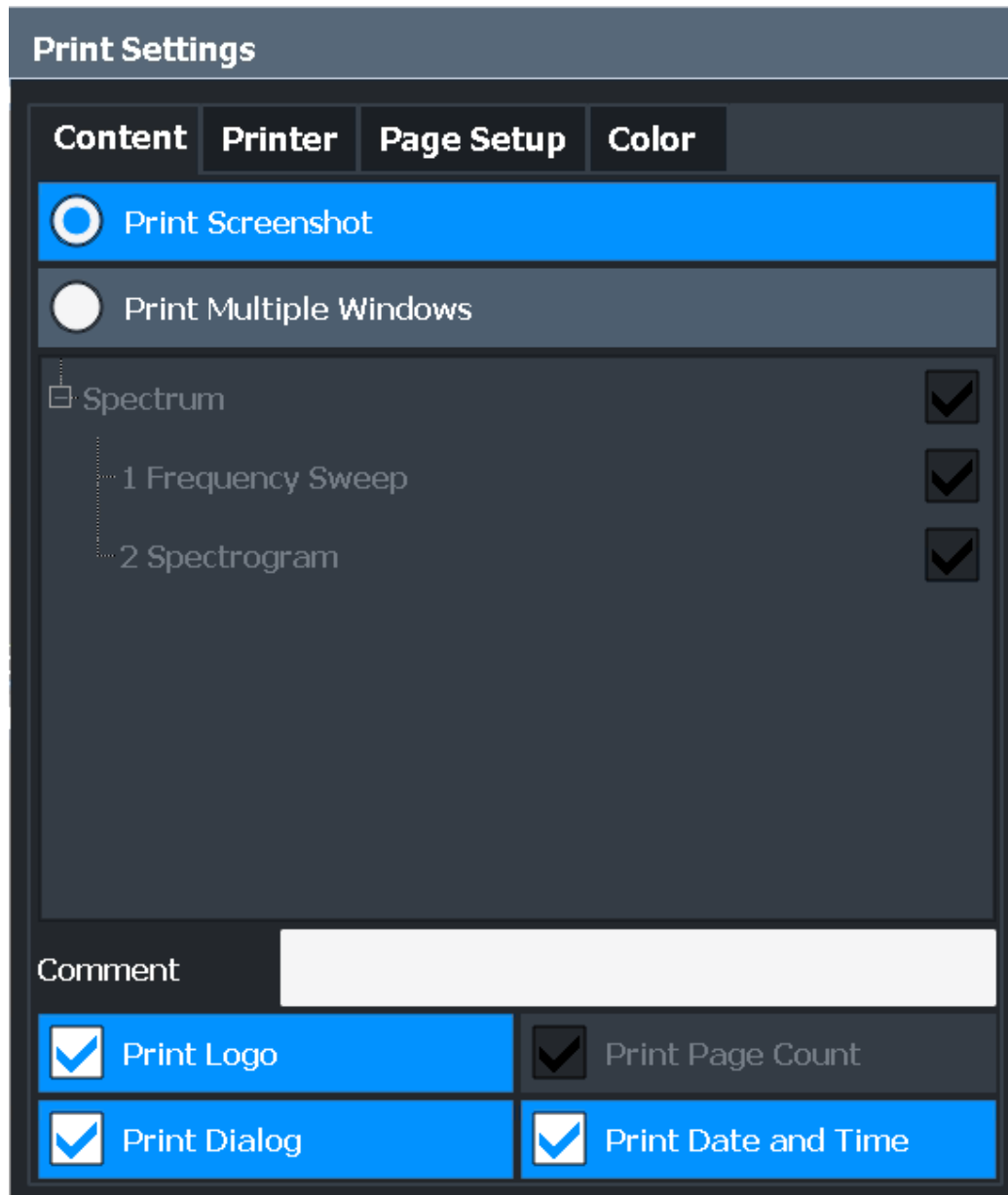

Print Screenshot	118
Print Multiple Windows	118
Comment	118
Print Logo	118
Print Page Count	118
Print Dialog	118
Print Date and Time	119

Print Screenshot

Selects all measurement results displayed on the screen for the current channel setup (or "MultiView"): diagrams, traces, markers, marker lists, limit lines, etc., including the channel bar and status bar, for printout on a single page. Displayed items belonging to the software user interface (e.g. softkeys) are not included. The position and size of the elements in the printout is identical to the display.

Remote command:

`HCOPY:CONTent` on page 877

Print Multiple Windows

Includes only the selected windows in the printout. All currently active windows for the current channel setup (or "MultiView") are available for selection. How many windows are printed on a single page of the printout is user-definable (see " [Windows Per Page](#) " on page 123).

This option is only available when printing on a printer or to a PDF file (see " [Destination](#) " on page 121). If the [Destination](#) is currently set to an image file or the clipboard, it is automatically changed to be a PDF file.

Remote command:

`HCOPY:CONTent` on page 877

`HCOPY:PAGE:WINDow<n>:STATe` on page 884

`HCOPY:PAGE:WINDow<n>:CHANnel:STATe` on page 883

Comment

Defines an optional comment to be included in the printout of the display. Maximum 120 characters are allowed. Up to 60 characters fit in one line. In the first line, a manual line-feed can be forced at any point by entering "@".

The comment is printed in the top left corner of each printout page. If a comment should not be printed, it must be deleted.

Tip: The current date and time can be inserted automatically, see " [Print Date and Time](#) " on page 119.

Remote command:

`HCOPY:ITEM:WINDow<n>:TEXT` on page 880

Print Logo

Activates/deactivates the printout of the Rohde & Schwarz company logo in the upper right corner.

Remote command:

`DISPlay:LOGO` on page 877

Print Page Count

Includes the page number for printouts consisting of multiple windows (" [Print Multiple Windows](#) " on page 118).

Remote command:

`HCOPY:PAGE:COUNt:STATe` on page 880

Print Dialog

Includes any currently displayed dialog in the screenshot printout.

This setting is only available if [Print Screenshot](#) is selected.

Print Date and Time

Includes or removes the current date and time at the bottom of the printout.

Remote command:

[HCOPY:TDSTamp:STATE<device>](#) on page 885

Print Preview Functions



Access: "Print"

The "Print Preview" of the printout according to the current configuration is available in all "Print Settings" dialog tabs.

The screenshot displays the 'Print Preview' window. At the top, it shows a window title bar with several tabs. Below this is a plot area containing a blue waveform on a grid. The plot has a horizontal axis with labels '0 Hz', '100.0 ps', and '200.0 ps'. Below the plot is a color-coded bar. At the bottom of the plot area, there is a status bar with text including '100.0 ps', 'Spec 2.5 GHz', and 'started'. Below the plot area, there are two main sections: 'Preview Page' and 'Zoom'. The 'Preview Page' section contains 'Page Up' and 'Page Down' buttons, and a '1 / 1' indicator. The 'Zoom' section contains 'Zoom In', 'Zoom Out', 'Fit Page', and 'Zoom 1:1' buttons. A large 'Print' button is located at the bottom right of the interface.

Zoom In / Zoom Out	120
Fit Page	120
Zoom 1:1	120
Page Up / Page Down	120
Print	120

Zoom In / Zoom Out

Zooms into (enlarges) or zooms out of (decreases) the preview display. Note that the zoom functions affect only the preview, not the printout itself.

Fit Page

Adapts the preview display zoom factor so that one complete page is visible as large as possible in the available display space. Note that the zoom functions affect only the preview, not the printout itself.

Zoom 1:1

Displays the printout in its original size, as it will be printed.

Page Up / Page Down

Depending on the selected contents (see "[Print Content Settings](#)" on page 116), the printout can consist of multiple pages. Use these functions to scroll within the preview to see the individual pages.

Print

Starts to print or store the selected screen contents to a file (see "[Print Content Settings](#)" on page 116).

Whether the output is sent to the printer or stored in a file or the clipboard depends on the selected print settings (see "[Printer Settings](#)" on page 120).

If the output is stored to a file, a file selection dialog box is opened to select the file-name and location. The default path is C:\Users\Public\Documents\Rohde-Schwarz Analyzer\user.

Remote command:

[HCOPY\[:IMMEDIATE<device>\]](#) on page 880

[HCOPY\[:IMMEDIATE<device>\]:NEXT](#) on page 880

Printer Settings



Access: "Print" > "Print Config" > "Printer" tab

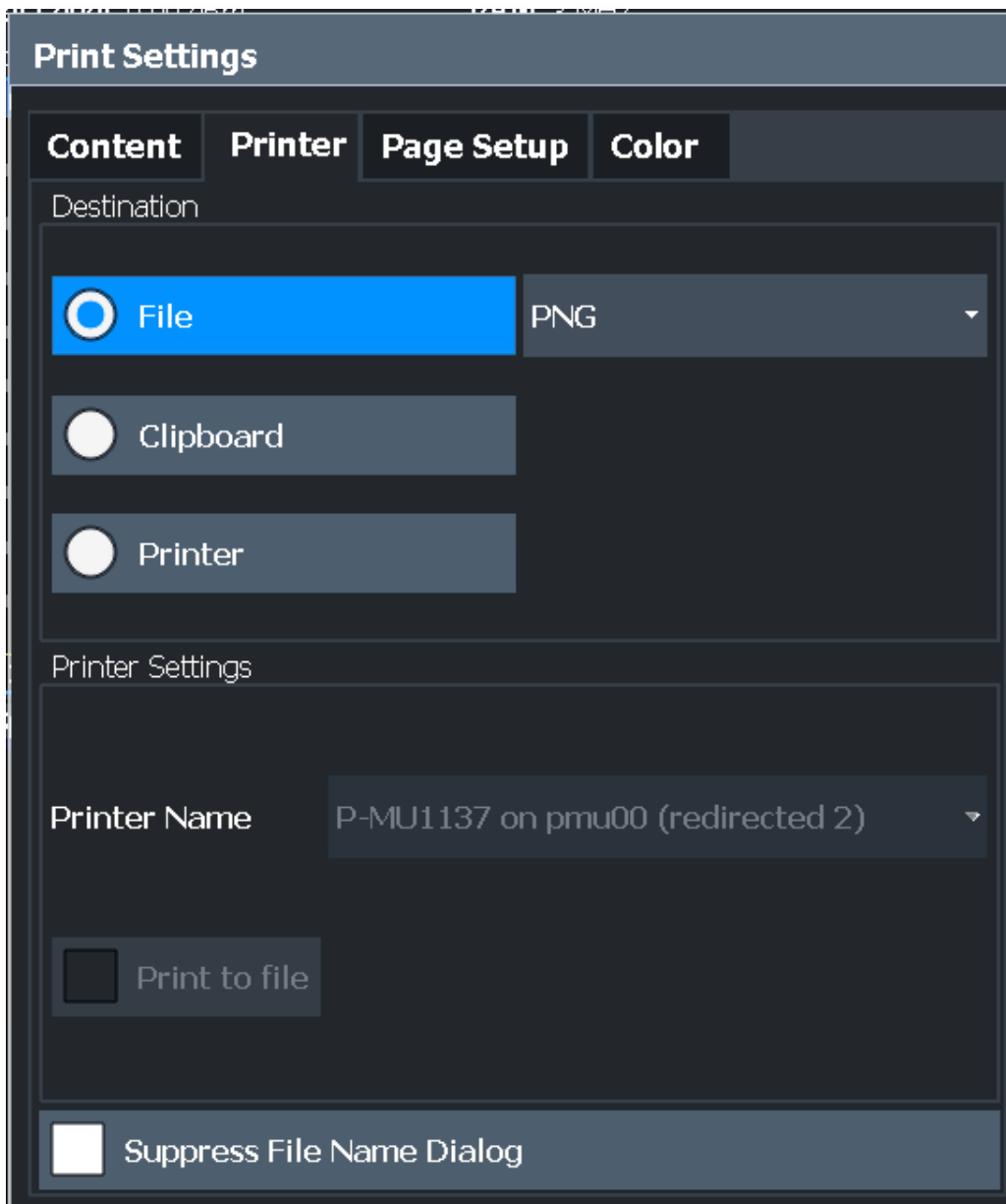

Destination	121
Suppress File Name Dialog	122
Printer Name	122
Print to file	122
Install Printer	122

Destination

Defines the medium to which the printout is output.

- "File" Stores the printout to a file in the selected format. The filename is queried at the time of storage, or a default name is used (see [Suppress File Name Dialog](#)). Multiple windows can only be printed to a file in PDF format. If you select an image file format, the content setting is automatically set to [Print Screenshot](#) . Page settings are not available for image files; however, you can configure the colors used for the screenshot (see [Print Color Settings](#) on page 124).
- "Clipboard" Copies the printout to the clipboard. Since only single pages can be copied, only screenshots can be copied to this destination, not multiple windows (see [Print Content Settings](#) on page 116). Page settings are not available; however, you can configure the colors used for the screenshot (see [Print Color Settings](#) on page 124). If you select the clipboard as the printing destination, the content setting is automatically set to [Print Screenshot](#) .
- "Printer" Sends the printout to the printer selected from the [Printer Name](#) list.
- Remote command:
[HCOPY:DESTination<device>](#) on page 878
[HCOPY:DEVIce:LANGUage<device>](#) on page 879

Suppress File Name Dialog

If the [Destination](#) is a file, the file selection dialog box is not displayed. Instead, the default storage location and filename are used.

```
(C:\Users\Public\Documents\Rohde-Schwarz\Analyzer\user
\FPL_ScreenShot_<date and time>).
```

Printer Name

Defines the printer to print to if a printer is selected as the [Destination](#) .

Any printers detected in the network are listed for selection.

Tip: the printout can also be stored in a print file using the selected printer driver, see [Print to file](#) " on page 122.

Remote command:

```
SYSTem:COMMUnicate:PRINter:ENUMerate[:NEXT]? on page 885
SYSTem:COMMUnicate:PRINter:ENUMerate:FIRSt? on page 885
SYSTem:COMMUnicate:PRINter:SElect<device> on page 886
```

Print to file

If a printer is selected as the [Destination](#) , use this option to store the data in a .prn file using the selected printer driver.

Install Printer

This softkey opens the standard Windows dialog box to install a new printer. All printers that are already installed are displayed.

Only user accounts with administrator rights can install a printer.

For further information, refer to the Microsoft Windows documentation.

Page Setup



Access: "Print" > "Print Config" > "Page Setup" tab

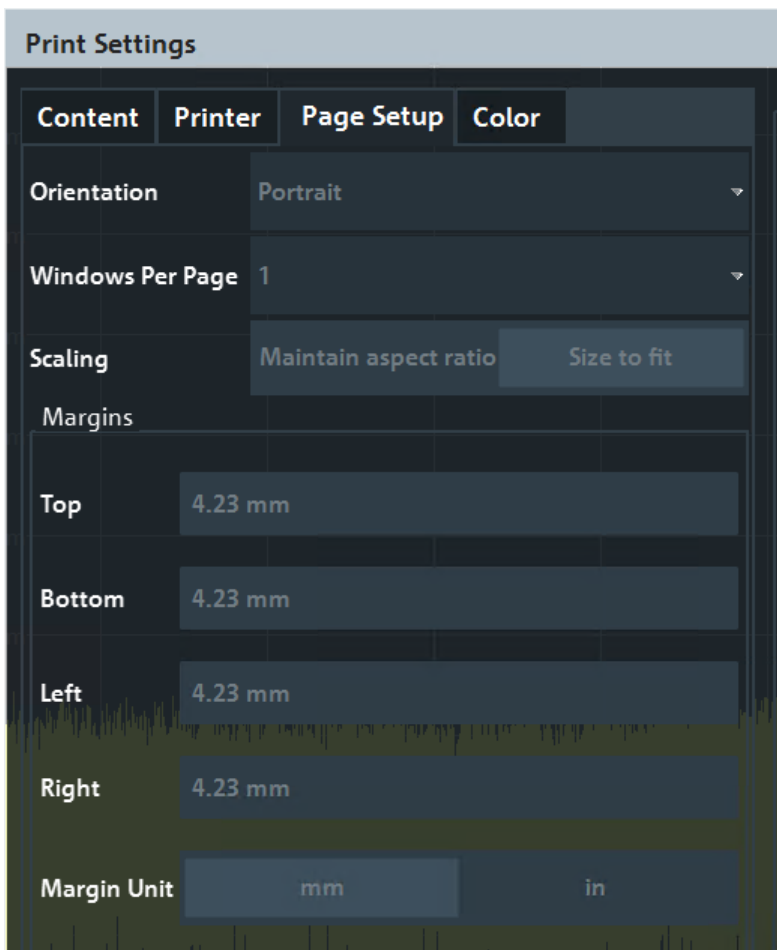

Page settings are only available when printing on a printer or to a PDF file (see " [Destination](#) " on page 121).

Orientation	123
Windows Per Page	123
Scaling	124
Margins	124

Orientation

Selects the page orientation of the printout: portrait or landscape.

Remote command:

[HCOPY:PAGE:ORIENTATION<device>](#) on page 882

Windows Per Page

Defines how many windows are displayed on a single page of the printout. This setting is only available if [Print Multiple Windows](#) is active (see "[Print Content Settings](#)" on page 116).

If more than one window is printed on one page, each window is printed in equal size.

Remote command:

`HCOPY:PAGE:WINDOW<n>:COUNT` on page 883

Scaling

Determines the scaling of the windows in the printout if [Print Multiple Windows](#) is active (see ["Print Content Settings"](#) on page 116).

If more than one window is printed on one page (see [Windows Per Page](#)), each window is printed in equal size.

"Maintain aspect ratio" Each window is printed as large as possible while maintaining the aspect ratio of the original display.

"Size to fit" Each window is scaled to fit the page size optimally, not regarding the aspect ratio of the original display.

Remote command:

`HCOPY:PAGE:WINDOW<n>:SCALE` on page 884

Margins

Defines margins for the printout page on which no elements are printed. The margins are defined according to the selected unit.

Remote command:

`HCOPY:PAGE:MARGIN<device>:BOTTOM` on page 881

`HCOPY:PAGE:MARGIN<device>:LEFT` on page 881

`HCOPY:PAGE:MARGIN<device>:RIGHT` on page 881

`HCOPY:PAGE:MARGIN<device>:TOP` on page 882

`HCOPY:PAGE:MARGIN<device>:UNIT` on page 882

Print Color Settings



Access: "Print" > "Print Config" > "Color" tab

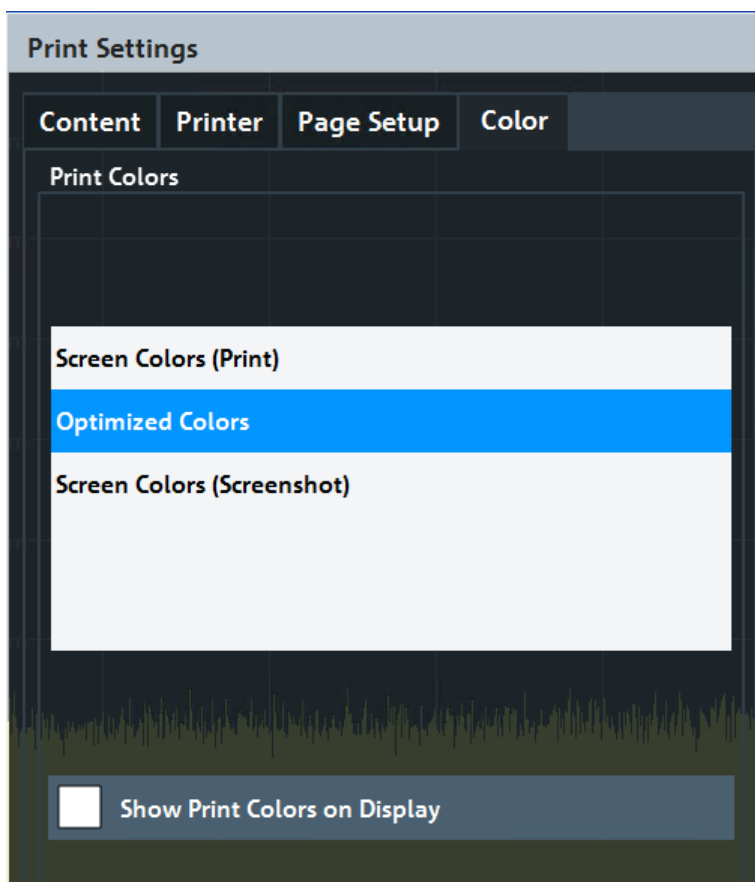

The settings provided here are identical to those in the "Print Colors" section of the "Display" > "Theme + Color" dialog box.

See " [Print Colors](#) " on page 137.

7.2.4.2 How to Store or Print Screenshots of the Display

The measurement results displayed on the screen can be printed or stored to a file very easily.

To start printing or storing results to a file



- ▶ If the R&S FPL1000 has already been set up according to your current requirements, simply press the "Print immediate" icon at the far right end of the toolbar.

The current measurement display is printed or stored to a file, as configured.

To print a screenshot

This configuration assumes a printer has already been installed. To install a new printer, use the [Install Printer](#) function (common Microsoft Windows procedure).



1. Select the "Printer" tool in the toolbar.
The "Print Settings" dialog box is displayed.

2. In the "Content" tab, define the elements of the screen and additional information to be included in the printout.
 - a) Select "Print Screenshot" to include all elements displayed on the screen in a single-page printout.
 - b) Optionally, add a comment to be printed at the top of the printout.
 - c) Optionally, activate the date and time or the logo so they are added to the printout.
 - d) Optionally, activate "Print Dialog" to include any dialog boxes currently displayed on the screen in the printout. This is useful, for example, to document the used settings for a particular result.
 - e) Check the "Print Preview" to make sure all relevant elements of the display are visible.
3. In the "Printer" tab, select "Printer" as the "Destination" .
4. Select the "Printer Name" to print to from the list of installed printers.
5. In the "Page Setup" tab, configure the layout of the printout page.
 - a) Select the page orientation.
 - b) Define the page margins.
 - c) Check the "Print Preview" to make sure all relevant elements of the display are visible.
6. In the "Color" tab, define the colors to be used for the printout.
 - a) By default, "Optimized Colors" are used to improve the visibility of the colors. The background is always printed in white and the grid in black. For a printout that reflects exactly what you see on the screen, select "Screen Colors (Screenshot)" .
 - b) Check the "Print Preview" to find out if the setting is appropriate.
7. Select "Print" to execute the print function.

The screenshot is printed on the printer as configured.
8. To print another screenshot using the same configuration any other time, simply press the "Print immediate" icon at the far right end of the toolbar.



To store a printout containing multiple windows



1. Select the "Printer" tool in the toolbar.

The "Print Settings" dialog box is displayed.
2. In the "Content" tab, define the elements of the screen and additional information to be included in the printout.
 - a) Select "Print Selected Windows" to include the selected windows in the printout, possibly on multiple pages.

- b) Select the result displays in the currently selected channel setup to be included in the printout.
Tip: Select the "MultiView" before configuring the printout to include result displays from any active channel setup.
 - c) Optionally, add a comment to be printed at the top of each page of the printout.
 - d) Optionally, activate the date and time or the logo so they are added to the printout pages.
3. Check the "Print Preview" to make sure all required result displays are included.
 - a) Scroll through the individual pages of the printout using "Page Up" and "Page Down" .
 - b) Use the zoom functions to make sure all relevant parts of the result display are visible.
 4. In the "Printer" tab, select "File" as the "Destination" .
 5. Select the file format from the selection list.
 6. By default, you define the filename individually for each print operation. To avoid having the "File Selection" dialog box being displayed for each print operation, select "Suppress File Name Dialog" . In this case, the previously used or default storage location and filename are used.

```
(C:\Users\Public\Documents\Rohde-Schwarz\Analyzer\user\FPL_ScreenShot_<date and time>).
```
 7. In the "Page Setup" tab, configure the layout of the printout page.
 - a) Select the page orientation.
 - b) Define the page margins.
 - c) Check the "Print Preview" to make sure all relevant elements of the display are visible.
 8. In the "Color" tab, define the colors to be used for the printout.
 - a) By default, "Optimized Colors" are used to improve the visibility of the colors. The background is always printed in white and the grid in black. For a printout that reflects the colors you see on the screen, but with a white background, select "Screen Colors (Print)" .
 - b) Check the "Print Preview" to find out if the setting is appropriate.
 9. Select "Print" to execute the print function.
 10. If you did not select the option to suppress the dialog, enter a filename in the file selection dialog box.
The selected data elements are stored to the file as configured.
 11. To store another file using the same configuration any other time, simply press the  "Print immediate" icon at the far right end of the toolbar.

7.2.4.3 Example for Storing Multiple Measurement Results to a PDF File

The following example describes the procedure to store results from measurements in the Spectrum application and the I/Q Analyzer to a single PDF file.

1. Configure and perform the measurements in the Spectrum application and I/Q Analyzer as required. Configure at least the following result displays:
 - Frequency Sweep, Spectrogram (Spectrum)
 - Magnitude, Spectrum (I/Q Analyzer)
2. Switch to the "MultiView" tab to display an overview of the result displays in all active channel setups.

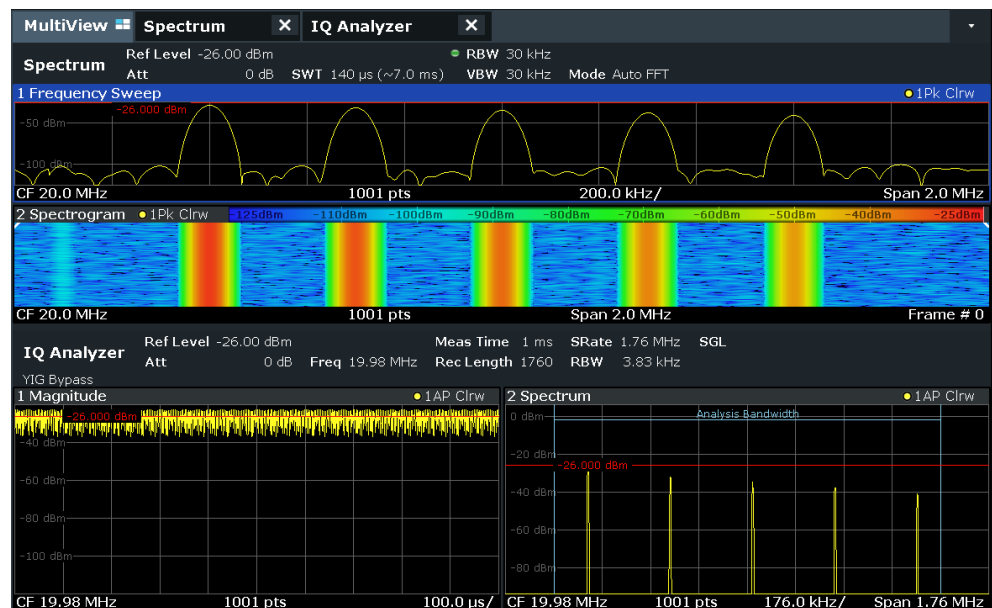

3. Select the "Printer" tool in the toolbar.
The "Print Settings" dialog box is displayed.
4. In the "Content" tab, select "Print Selected Windows" .
5. Select the result displays listed in [step 1](#).
6. Enter the comment *Measurement Test Report* to be inserted at the top of each page.
7. Select "Print Page Count" and "Print Date and Time" .
8. In the "Content" tab, select "Print Selected Windows" .
9. In the "Printer" tab, select "File" as the "Destination" .
10. Select "PDF" from the file format selection list.
11. Select "Suppress File Name Dialog" .
12. In the "Page Setup" tab, select "Landscape" as the "Orientation" .

13. Select "Windows Per Page" : 1 to print a single result display on each page.
14. Select the "Scaling" option "Size to fit" to maximize the result display on each page.
15. In the "Color" tab, select "Screen Colors (Print)" for a printout that reflects the colors you see on the screen, but with a white background.
16. Check the "Print Preview" to make sure all required result displays are included and all relevant data elements are visible.
 - a) Scroll through the individual pages of the printout using "Page Up" and "Page Down" .
 - b) Use the zoom functions to make sure all relevant parts of the result display are visible.
17. Select "Print" to execute the print function.

The selected data elements are stored to the file as configured.

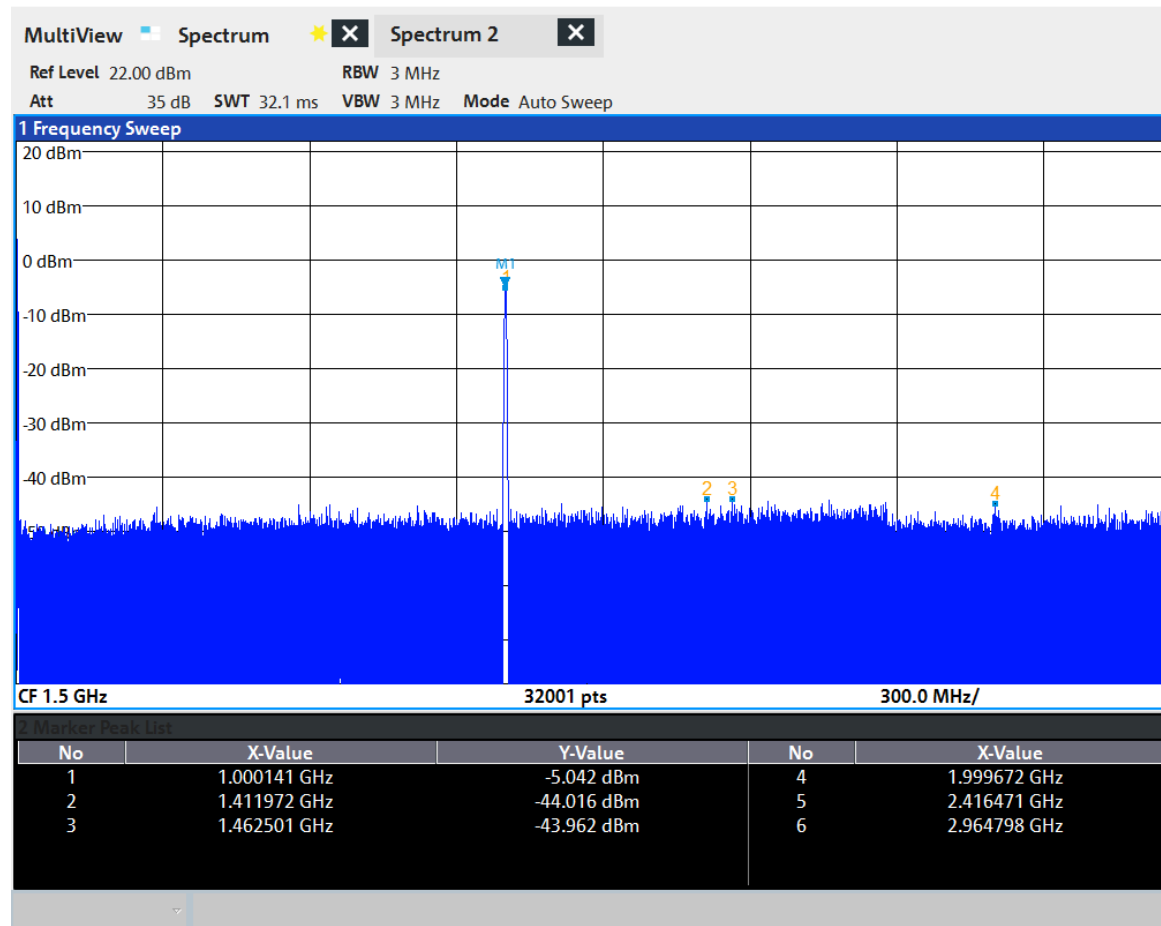

08:17:47 09.03.2017

7.3 General Instrument Setup

Access: [SETUP]

Some basic instrument settings can be configured independently of the selected operating mode or application. Usually, you configure most of these settings initially when you set up the instrument according to your personal preferences or requirements. Then you only adapt individual settings to special circumstances when necessary. Some special functions are provided for service and basic system configuration.



Network and remote settings

Settings for network and remote operation are described in [Chapter 7.4.3, "Network and Remote Control Settings"](#), on page 206.

- [Reference Frequency](#)..... 130
- [Display Settings](#)..... 131
- [Language Settings](#)..... 141
- [System Configuration Settings](#)..... 142
- [Service Functions](#)..... 147
- [Transducers](#)..... 152
- [Alignment](#)..... 163

7.3.1 Reference Frequency

Access: [Setup] > "Reference Int/Ext"

The R&S FPL1000 can use the internal reference source or an external reference source as the frequency standard for all internal oscillators. A 10 MHz crystal oscillator is used as the internal reference source. In the external reference setting, all internal oscillators of the R&S FPL1000 are synchronized to the external reference frequency.

External references are connected to one of the [REF INPUT] connectors on the rear panel. For details see the R&S FPL1000 "Getting Started" manual.

The default setting is the internal reference. When an external reference is used, "EXT REF" is displayed in the status bar.



OCXO Option

The OCXO (R&S FPL1-B4) option generates a 10 MHz reference signal with a very precise frequency. If installed, and if no external signal is used, this signal is used as an internal reference. It can also be used to synchronize other connected devices via the Ref. Out 10 MHz connector.

When the instrument is switched on, the OCXO requires an extended warm-up time (see data sheet).

Remote command:

[SENSe:]ROSCillator:SOURce on page 890

7.3.2 Display Settings

7.3.2.1 Display Settings

Access: [Setup] > "Display"

Some general display settings are available regardless of the current application or operating mode. For information on optimizing your display for measurement results, see the application-specific result configuration descriptions.

- [General Display Settings](#).....131
- [Displayed Items](#).....132
- [Display Theme and Colors](#).....136
- [External Monitor Settings](#).....138
- [Touch\(screen\) Settings](#).....138

General Display Settings

Access: [Setup] > "Display" > "General"

This section includes general screen display behavior and date and time display.

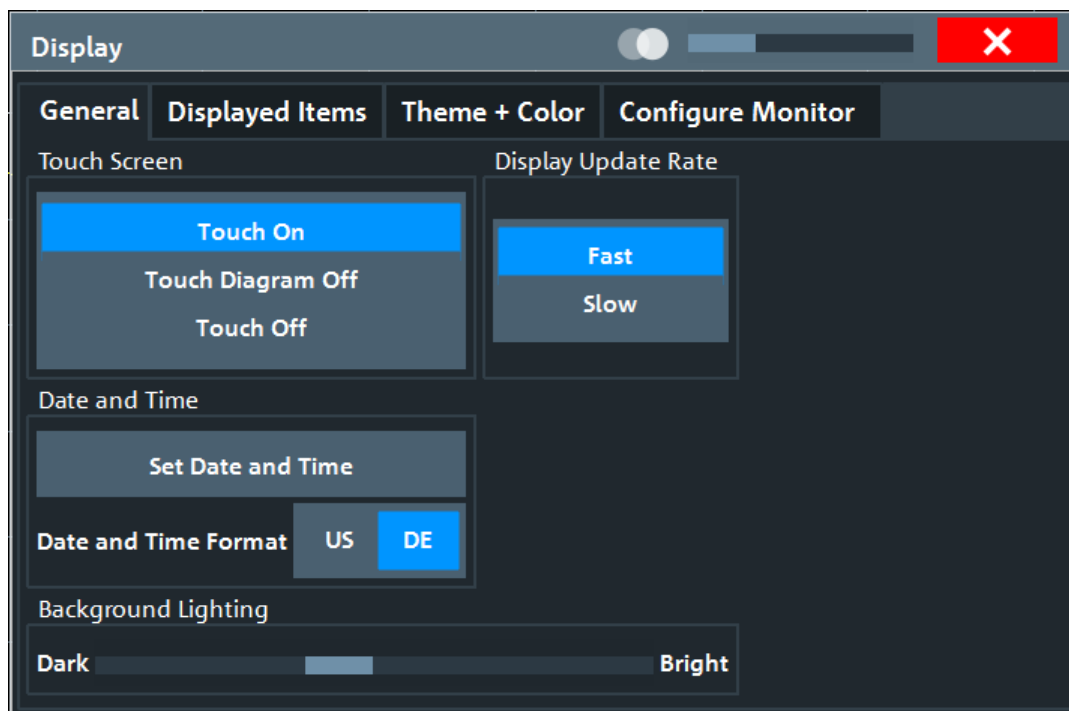

- [Deactivating and Activating the Touchscreen](#) 132
- [Display Update Rate](#) 132
- [Set Date and Time](#) 132
- [Date and Time Format](#) 132
- [Background Lighting](#)..... 132

Deactivating and Activating the Touchscreen

The touchscreen function can be deactivated, e.g. when the instrument is being used for demonstration purposes and tapping the screen must not provoke an action.

To reactivate the touchscreen, simply press the [Setup] key on the front panel. The "Display" dialog box is opened automatically and the "Touch Screen" option is set to "On" .

"Touch On" Touchscreen function is active for the entire screen.

" Touch Off" Touchscreen is deactivated for the entire screen.

" Touch Diagram Off"

Touchscreen is deactivated for the diagram area of the screen, but active for the surrounding softkeys, toolbars and menus.

Remote command:

`DISPlay:TOUChscreen[:STATe]` on page 901

Display Update Rate

By default, a fast update rate ensures the most recent measurement results on the display. However, when performance is poor due to slow data transfer (for example during remote control), it can be helpful to decrease the frequency with which the screen display is updated.

Set Date and Time

The current date and time on the instrument is set using the standard Windows "Date and Time Properties" dialog box. Select the "Set Date and Time" button in the "Display" dialog box, or select the date and time display in the status bar to open the Windows dialog box.

Date and Time Format

Switches the time and date display on the screen between US and German (DE) format.

Remote command:

`DISPlay[:WINDow<n>]:TIME:FORMat` on page 901

Background Lighting

Changes the brightness of the display in eight steps.

Remote command:

`DISPlay:BLIGHting` on page 900

Displayed Items

Access: [Setup] > "Display" > "Displayed Items"

Several elements on the screen display can be hidden or shown as required, for example to enlarge the display area for the measurement results.

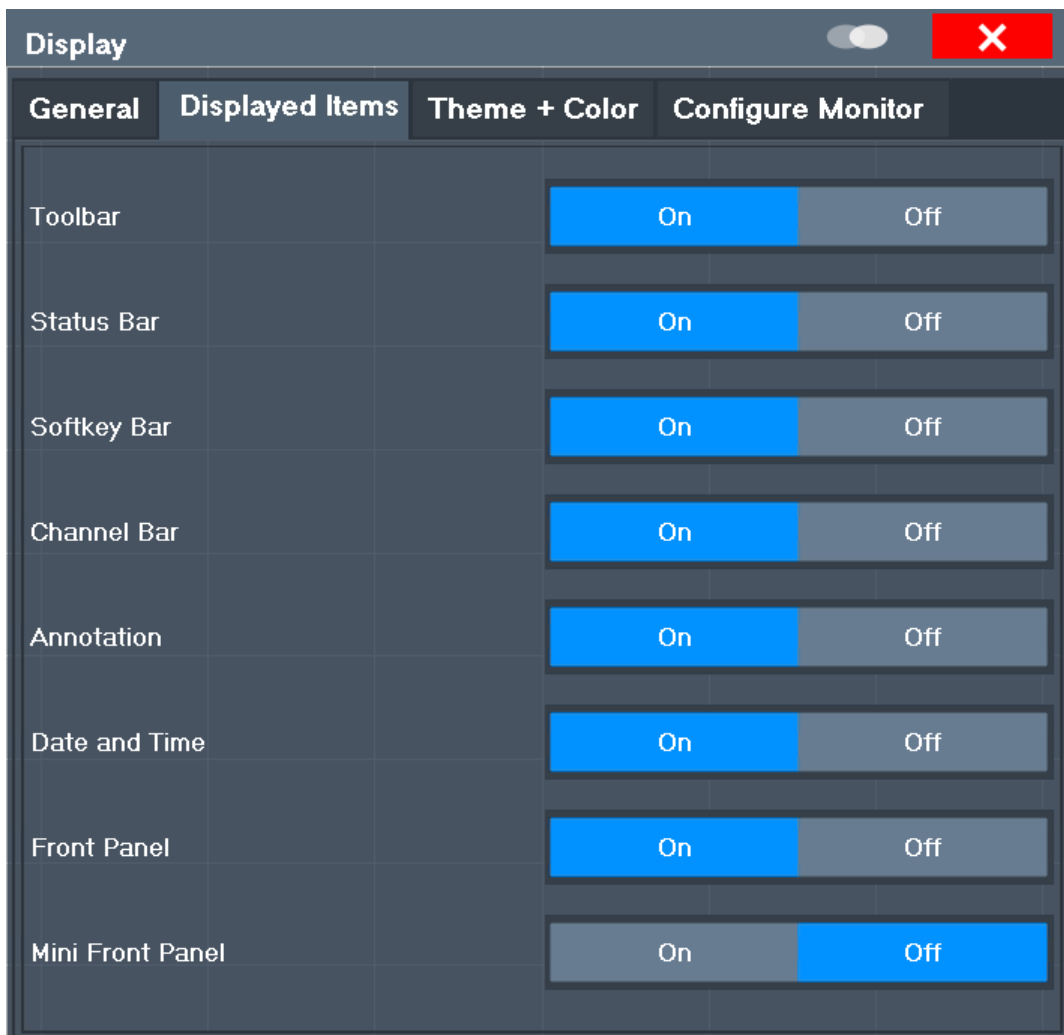

Toolbar	133
Status Bar	134
Softkey Bar	134
Channel Bar	134
Diagram Footer (Annotation)	134
Date and Time	134
Front Panel	135
Mini Front Panel	135

Toolbar

The toolbar provides access to frequently used functions via icons at the top of the screen. Some functions, such as zooming, finding help, printing screenshots or storing and loading files are not accessible at all without the toolbar.

Remote command:

`DISPlay:TBAR[:STATe]` on page 900

Status Bar

The status bar beneath the diagram indicates the global instrument settings, the instrument status and any irregularities during measurement or display.

Some of the information displayed in the status bar can be queried from the status registry via remote commands, see [Chapter 9.12, "Using the Status Register"](#), on page 947.

Remote command:

`DISPlay:SBAR[:STATe]` on page 900

Softkey Bar

Softkeys are virtual keys provided by the software. Thus, more functions can be provided than can be accessed directly via the function keys on the device.

The functions provided by the softkeys are often also available via dialog boxes. However, some functions are not accessible at all without the softkey bar.

Note: The softkey bar is hidden while the SmartGrid is displayed and restored automatically when the SmartGrid is closed.

Remote command:

`DISPlay:SKEYs[:STATe]` on page 900

Channel Bar

The channel setup bar provides information on firmware and measurement settings for a specific channel setup.

Remote command:

`DISPlay:ANNotation:CBAR` on page 899

Diagram Footer (Annotation)

The diagram footer beneath the diagram contains information on the x-axis of the diagram display, such as:

- The current center frequency and span settings
- The displayed span per division
- The number of sweep points

Remote command:

`DISPlay:ANNotation:FREQuency` on page 900

Date and Time

The date and time display can be switched off independently of the status bar.

You can set the current date and time and configure the display format in the "General" tab of the "Display" dialog box.

Remote command:

`DISPlay[:WINDow<n>]:TIME` on page 901

Front Panel

The "Front Panel" display simulates the entire front panel of the device (except for the external connectors) on the screen. Thus, you can interact with the R&S FPL1000 without the keypad and keys on the front panel of the device. That is useful, for example, when working with an external monitor or operating via remote control from a computer.

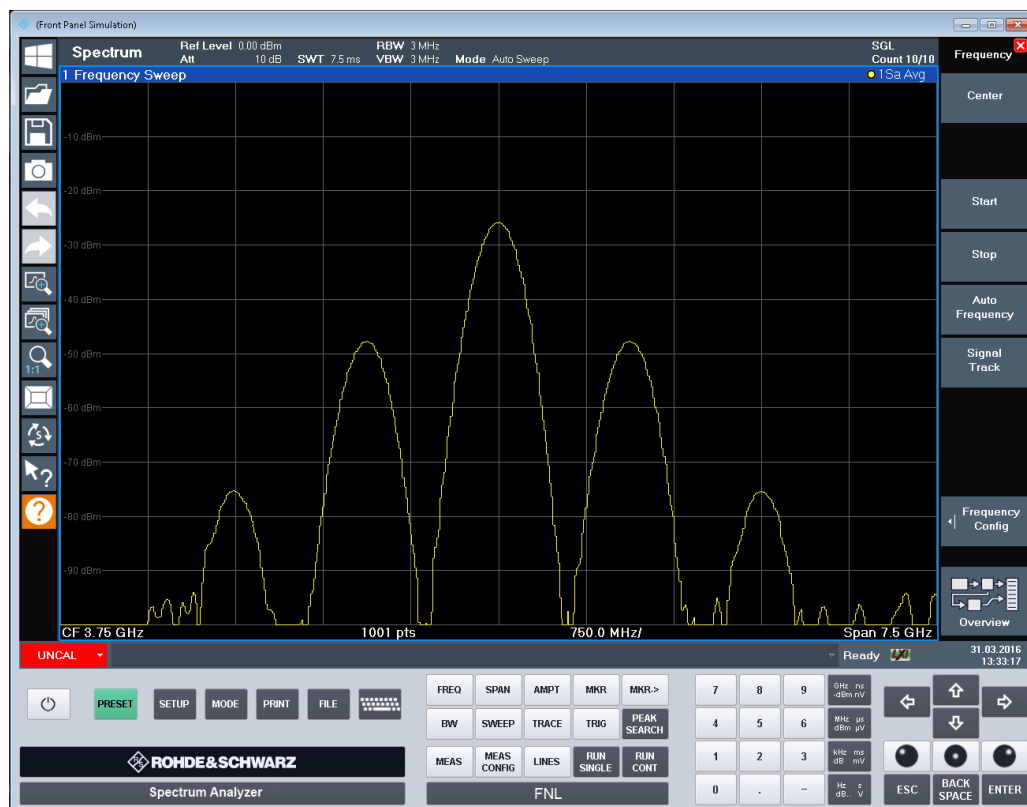

To activate or deactivate the front panel temporarily, press the [F6] key on the external keyboard (if available) or the remote computer.

For more information, see [Chapter 7.3.2.3, "How to Work with the Soft Front Panels"](#), on page 140.

Remote command:

`SYSTEM:DISPLAY:FPANEL[:STATE]` on page 902

Mini Front Panel

If you require a front panel display but do not want to lose too much space for results in the display area, a mini front panel is available. The mini version displays only the main function keys in a separate window in the display area.

**Note:**

You can also activate the mini front panel using the key combination [ALT + m] (be aware of the keyboard language defined in the operating system!). That is useful when you are working from a remote PC and the front panel function is not active.

Remote command:

`SYSTem:DISPlay:FPANel[:STATe]` on page 902

Display Theme and Colors

Access: [Setup] > "Display" > "Theme + Color"

You can configure the used colors and styles of display elements on the screen.

For step-by-step instructions see [Chapter 7.3.2.2, "How to Configure the Colors for Display and Printing"](#), on page 139.

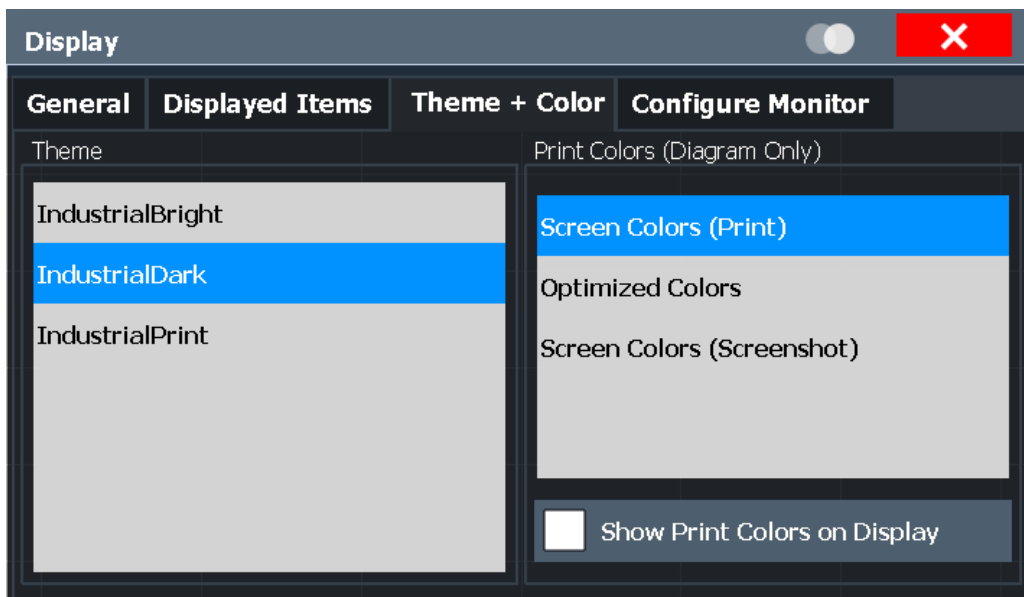

Theme 137
 Print Colors 137
 Showing Print Colors on Display..... 138

Theme

The theme defines the colors and style used to display softkeys and other screen objects.

The default theme is "IndustrialDark" .

Remote command:

`DISPlay:THEMe:SElect` on page 903

Print Colors

Defines the color settings used for printout.

If "Show Print Colors on Display" is activated, the currently selected print colors are displayed as a preview for your selection.

Gui setting	Description	Remote command
"Optimized Colors"	Selects an optimized color setting for the printout to improve the visibility of the colors (default setting). Trace 1 is blue, trace 2 black, trace 3 green, and the markers are turquoise. The background is always printed in white and the grid in black.	<code>HCOP:CMAP:DEF2</code>
"Screen Colors (Print)"	Selects the current screen colors for the printout. The background is always printed in white and the grid in black.	<code>HCOP:CMAP:DEF1</code>
"Screen Colors (Screenshot)"	Selects the current screen colors without any changes for a screenshot.	<code>HCOP:CMAP:DEF4</code>

Remote command:

`HCOPY:CMAP<it>:DEFault<ci>` on page 878

Showing Print Colors on Display

Temporarily shows the currently selected print colors on the screen display. This function can be used as a preview for printing.

External Monitor Settings

Access: [Setup] > "Display" > "Configure Monitor"

You can connect an external monitor (or projector) to the DVI or display port connector on the instrument's rear panel (see the R&S FPL1000 getting started manual).



Screen resolution and format

The touchscreen of the R&S FPL1000 is calibrated for a 16:10 format. If you connect a monitor or projector using a different format (e.g. 4:3), the calibration will not be correct and the screen will not react to your touch actions properly.

The touchscreen has a screen resolution of 1280x800 pixels. Most external monitors have a higher screen resolution. If the screen resolution of the monitor is set higher than the instrument's resolution, the application window uses an area of 1280x800 pixels on the monitor display. For full screen display, adjust the monitor's screen resolution.

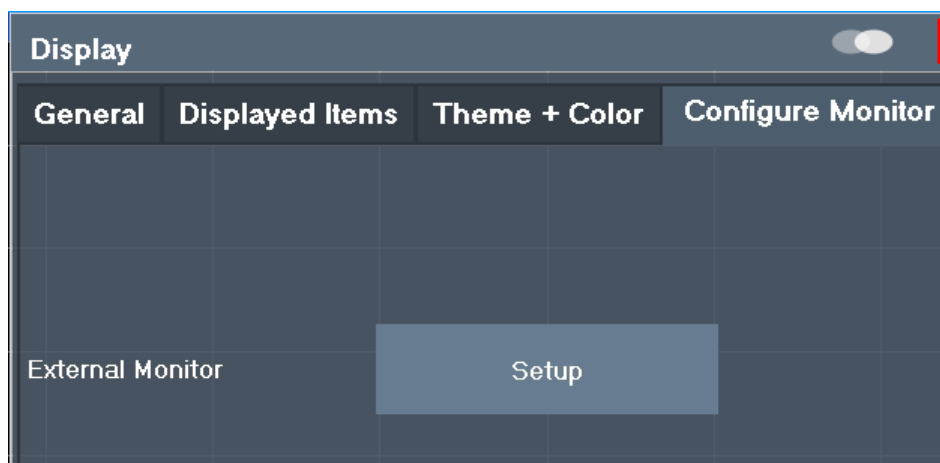

[Setup](#) 138

Setup

Opens the standard Windows configuration dialog box to configure the used display devices.

Touch(screen) Settings

Access: [Setup] > "Display" > "Touch"

These options concern the behavior of the firmware for touch gestures on the screen.

Note that these settings remain unchanged after a channel preset.

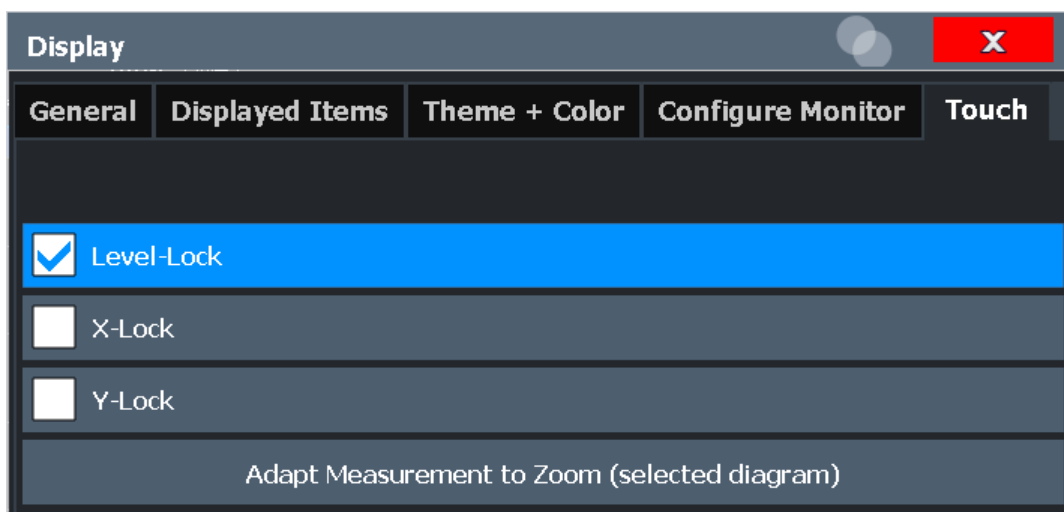

Level Lock.....	139
X-Lock.....	139
Y-Lock.....	139
Adapt Measurement to Zoom (selected diagram).....	139

Level Lock

If activated (default), the reference level (and thus the attenuation) is locked, that is: remains unchanged during touch gestures on the screen.

X-Lock

If activated, the x-axis of the diagram is not changed during subsequent touch gestures.

Y-Lock

If activated, the y-axis of the diagram is not changed during subsequent touch gestures.

Adapt Measurement to Zoom (selected diagram)

If you already performed a graphical zoom using the "Single Zoom" on page 556 or "Multi-Zoom" on page 556 functions, this function automatically adapts the measurement settings to maintain the currently zoomed display.

7.3.2.2 How to Configure the Colors for Display and Printing

You can configure the style and colors with which various screen objects are displayed or printed.

To select a color set

1. Press the [Setup] key and select the "Display" softkey.
2. Select the "Theme + Color" tab.
3. In the "Screen Colors" area, do one of the following:

- Select a predefined set of colors for screen display.
 - Select "User Defined Colors" to configure the color set yourself.
4. In the "Print Colors" area, do one of the following:
 - Select a predefined set of colors for printing screenshots.
 - Select "User Defined Colors" to configure the color set yourself.
 5. Activate the "Show Print Colors on Display" option to see a preview of the print colors.

To configure a user-defined color set



1. In the "Theme + Color" tab of the "Display" dialog box, select "User Defined Colors" either for the screen or the print colors.
2. Select "Modify User Defined Colors" .
The "Screen Color Setup" dialog box is opened.
3. From the "Selected Object:" list, select the object to which you want to assign a color.
4. Do one of the following:
 - Select a color from the "Predefined Colors" .
 - Select the "Userdefined Colors ..." button to define a different color.The "Preview" area indicates the currently selected color.
5. To assign a user-specific color to the selected object, do one of the following:
 - Select the color from the palette.
 - Enter values for the "Tint:" , "Saturation:" , and "Brightness:" .
Note: In the continuous color spectrum ("Tint:"), 0 % represents red and 100 % represents blue.
 - Enter an "ARGB:" value in hexadecimal format.
6. Select the next object to which you want to assign a color from the "Selected Object:" list.
7. Repeat these steps until you have assigned a color to all objects you want to configure.
8. Select "OK" to close the dialog box.
The colors are applied to the assigned objects.

7.3.2.3 How to Work with the Soft Front Panels

Basic operation with the soft front panels is identical to normal operation, except for the following aspects:

To activate a key, select the key on the touchscreen.

To simulate the use of the rotary knob, use the additional keys displayed between the keypad and the arrow keys:

Icon	Function
	Turn left
	Enter
	Turn right

Mini front panel

The mini front panel provides only the keys on the touchscreen, to operate the R&S FPL1000 via an external monitor or remote desktop.

By default, the "Auto close" option is activated and the mini front panel window closes automatically after you select a key. This is useful if you only require the mini front panel display occasionally to press a single function key.

If you want the window to remain open, deactivate the "Auto close" option. You can close the window manually by selecting "Close panel" or the key combination [ALT + M] (be aware of the keyboard language defined in the operating system!).

To display the soft front panel or mini front panel

1. Press the [Setup] key and select the "Display" softkey.
2. Select the "Displayed Items" tab.
3. Select "Front Panel" : "On" or "Mini Front Panel" : "On" .



To activate or deactivate the front panel temporarily, press the [F6] key on the external keyboard (if available) or on the remote computer.

If the softkey menu is visible, you can display the "Mini Front Panel" quickly and easily by double-clicking the title of the softkey menu.

To close the mini front panel, click the  "Close" icon at the top of the panel.

7.3.3 Language Settings

Access: [SETUP] > "Language"

The graphical user interface of the R&S FPL1000 can be displayed in various languages so you can operate the instrument in your most familiar language.

- ▶ Select the language from the list of available languages.

The software-defined interface elements (such as softkeys, dialog boxes, diagram texts etc.) are displayed in the selected language.

Remote command:

[SYSTem:DISPlay:LANGuage](#) on page 903

7.3.4 System Configuration Settings

Access: [Setup] > "System Configuration"

- [Hardware Information](#)..... 142
- [Information on Versions and Options](#)..... 142
- [System Messages](#)..... 144
- [Firmware Updates](#)..... 145
- [General Configuration Settings](#)..... 146
- [Additional Interfaces](#)..... 147

7.3.4.1 Hardware Information

Access: [Setup] > "System Configuration" > "Hardware Info"

An overview of the installed hardware in your R&S FPL1000 is provided.

Every listed component is described by its serial number, order number, model information, hardware code, and hardware revision.

This information can be useful when problems occur with the instrument and you require support from Rohde & Schwarz.

System Configuration						
Hardware Info	Versions + Options	System Messages	Firmware Update	Config		
COMPONENT	SERIAL #	ORDER #	MODEL	HWC	REV	
FRONTEND	100000	1304.0040	02	00	00.00	
MOTHERBOARD	100000	1323.0041	02	00	01.00	
OCXO	000000	1300.3180	00	00	00.00	
UNKNOWN						
CPU BOARD - SIM	234561/234	1234.5678				
DEFAULT IDENTITY						
NEPTUN DEVICE	100005	1319.2008	40			

Remote command:

[DIAGnostic:SERVice:HWInfo?](#) on page 909

[DIAGnostic:SERVice:BATTery:LEVel?](#) on page 908

7.3.4.2 Information on Versions and Options

Access: [Setup] > "System Configuration" > "Versions + Options"

Information on the firmware version and options installed on your instrument is provided. The unique Rohde & Schwarz device ID is also indicated here, as it is required for license and option administration.

You can also install new firmware options in this dialog box.

The table also contains:

- The open source acknowledgements (PDF file) for the firmware and other software packages used by the R&S FPL1000
- The European License Agreement (EULA) for LucasFonts RSCorpid



Expired option licenses

If an option is about to expire, a message box is displayed to inform you. You can then use the "Install Option" function to enter a new license key.

If an option has already expired, a message box appears for you to confirm. In this case, all instrument functions are unavailable (including remote control) until the R&S FPL1000 is rebooted. You must then use the "Install Option" function to enter the new license key.

System Configuration			
Hardware Info	Versions + Options	System Messages	Firmware Update
Item	Option	Version	License
FE-FPGA (SPA)		1.0.0.0	
AUX-FPGA		1.0.3.0	
Data Sheet		01.00	
Time Control Management			active
Smart Card Service			installed
Additional Interfaces	B5		
GPIB Interface	B10		
RF Preamplifier	B22		permanent
RF Att 1 db	B25		
40 MHz Analysis Bandwidth	B40		permanent
Analog Modulation Analysis	K7		permanent
Power Sensor Measurements	K9		permanent
Noise Figure Measurements	K30	1.05	permanent
Open Source Acknowledgement			Open ...
LucasFonts RsCorpid EULA			Open ...

For details on options refer to the "Getting Started" manual, "Checking the Supplied Items".

Remote commands:

[SYSTem:FORMat:IDENT](#) on page 911

[DIAGnostic:SERvice:BIOSinfo?](#) on page 908

[DIAGnostic:SERvice:VERSinfo?](#) on page 909

Open Source Acknowledgment: Open

Displays a PDF file containing information on open source code used by the R&S FPL1000 firmware.

LucasFonts RsCorpid EULA: Open

Displays a PDF file containing copyright information on the RsCorpid font used by the R&S FPL1000 firmware.

IVI Shared Components EULA: Open

Displays a PDF file containing copyright information on the IVI shared components used by the R&S FPL1000 firmware.

Install Option

Opens an edit dialog box to enter the license key for the option that you want to install.

Install Option by XML

Opens a file selection dialog box to install an additional option to the R&S FPL1000 using an XML file. Enter or browse for the name of an XML file that contains the option key and select "Select" .

7.3.4.3 System Messages

Access: [Setup] > "System Configuration" > "System Messages"

The system messages generated by the R&S FPL1000 are displayed.

The messages are displayed in the order of their occurrence; the most recent messages are placed at the top of the list. Messages that have occurred since you last visited the system messages tab are marked with an asterisk "*".

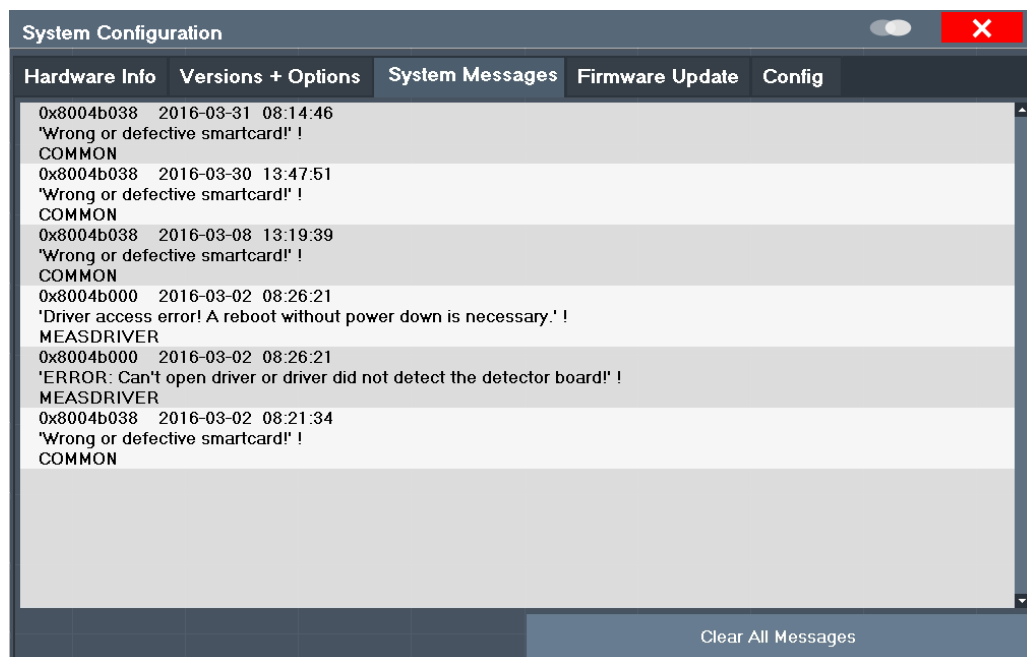

If the number of error messages exceeds the capacity of the error buffer, "Message Buffer Overflow" is displayed. To clear the message buffer use the "Clear All Messages" button.

The following information is available:

No	device-specific error code
Message	brief description of the message
Component	hardware messages: name of the affected module
	software messages: name of the affected software
Date/Time	date and time of the occurrence of the message

Remote command:

`SYSTem:ERRor:LIST?` on page 910

7.3.4.4 Firmware Updates

Access: [Setup] > "System Configuration" > "Firmware Update"

During instrument start, the installed hardware is checked against the current firmware version to ensure the hardware is supported. If not, an error message is displayed ("Wrong Firmware Version") and you are asked to update the firmware. Until the firmware version is updated, self-alignment fails. To see which components are not supported, see the [System Messages](#).

The firmware on your R&S FPL1000 may also need to be updated in order to enable additional new features or if reasons for improvement come up. Ask your sales representative or check the Rohde&Schwarz website for availability of firmware updates. A firmware update package includes at least a setup file and release notes.



Before updating the firmware on your instrument, read the release notes delivered with the firmware version.

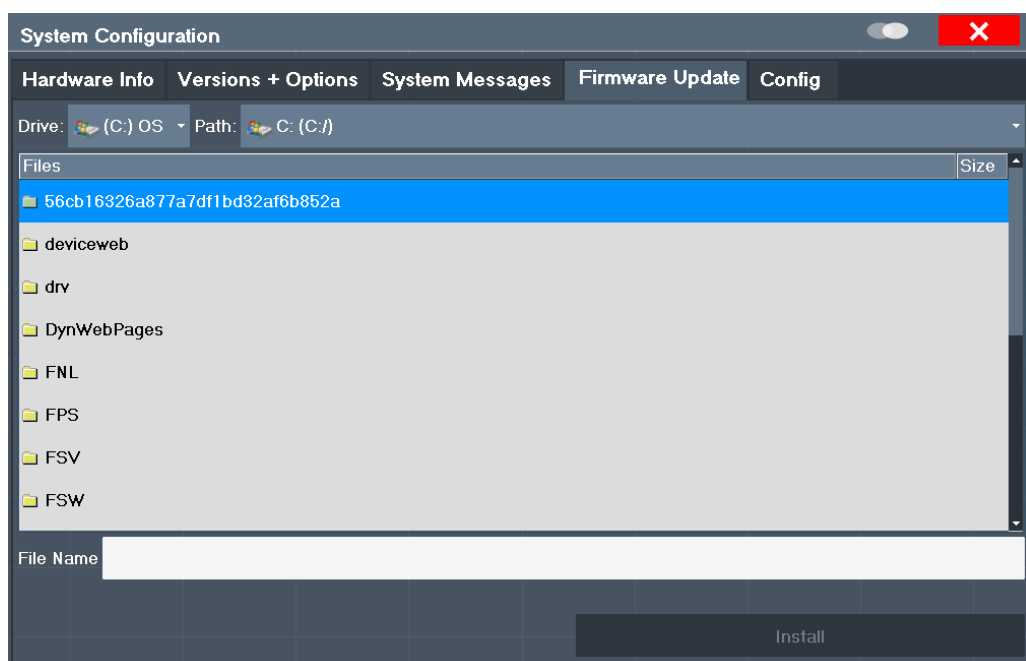

Enter the name or browse for the firmware installation file and press the "Install" button.

Remote command:

`SYSTem:FIRMware:UPDate` on page 911

How to Update the Instrument Firmware

1. Download the update package from the Rohde&Schwarz website and store it on a memory stick, on the instrument, or on a server network drive that can be accessed by the instrument.
2. **NOTICE!** Stop measurement. The firmware update must not be performed during a running measurement.
If a measurement is running, stop it by pressing the highlighted [Run Cont] or [Run Single] key.
3. Select the [Setup] key.
4. Select the "System Config" softkey.
5. Select the "Firmware Update" tab.
6. In the file selection dialog box select the `FPLSetup*.exe` file.
7. Select "Install" to start the update.
8. After the firmware update, the R&S FPL1000 reboots automatically.
9. Depending on the previous firmware version, a reconfiguration of the hardware might be required during the first startup of the firmware. The reconfiguration starts automatically, and a message box informs you about the process. When the reconfiguration has finished, the instrument again reboots automatically.

Note: Do not switch off the instrument during the reconfiguration process!

Now the firmware update is complete.

It is recommended that you perform a self-alignment after the update (see [Chapter 7.3.7.4, "How to Align the Instrument"](#), on page 166).

7.3.4.5 General Configuration Settings

Access: [Setup] > "System Configuration" > "Config"

General system settings, for example concerning the initial behaviour of the R&S FPL1000 after booting, can also be configured.

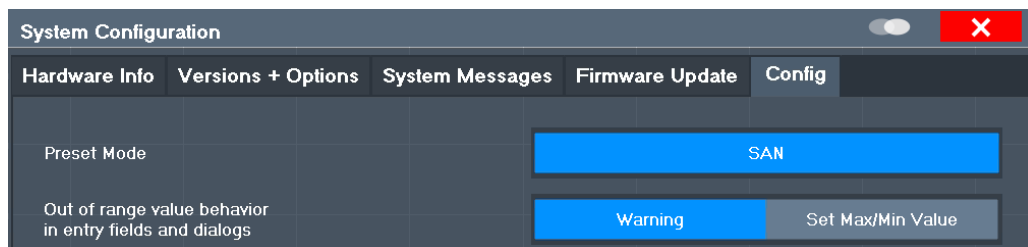

Out-of-range value behavior 147

Out-of-range value behavior

By default, if you enter a value that is outside the valid range in an input field for a setting, a warning is displayed and the value is not accepted. Alternatively, entries below the minimum value can automatically be set to the minimum possible entry, and entries above the maximum value set to the maximum possible entry. This behavior avoids errors and facilitates setting correct values.

7.3.4.6 Additional Interfaces

The following settings are only available if the "Additional interfaces" option R&S FPL1-B5 is installed.

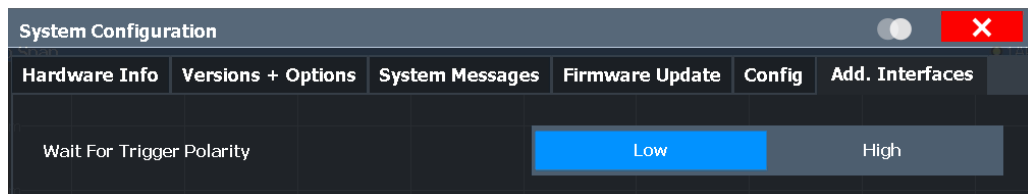

Wait for Trigger Polarity

The optional AUX PORT connector of the R&S FPL1000 can provide a signal that indicates the instrument is ready to receive a trigger signal.

(For details on the connector see the R&S FPL1000 Getting Started manual).

The signal polarity that indicates the trigger availability is configurable.

"Low" A low signal (= 0 V) indicates the instrument is ready to receive a trigger.

"High" A high signal (= 5 V) indicates the instrument is ready to receive a trigger.

Remote command:

OUTPut:UPORT:WTRigger:POLarity LOW | HIGH (see the R&S FPL1000 user manual)

7.3.5 Service Functions

Access: [Setup] > "Service"

When unexpected problems arise with the R&S FPL1000 some service functions may help you solve them.

For more helpful information for support, see also [Chapter 11.5, "Collecting Information for Support"](#), on page 968

- [R&S Support Information](#)..... 148
- [Self-test Settings and Results](#)..... 149
- [Calibration Signal Display](#)..... 150
- [Service Functions](#)..... 150

7.3.5.1 R&S Support Information

Access: [Setup] > "Service" > "R&S Support"

In case of errors you can store useful information for troubleshooting and send it to your Rohde & Schwarz support center.

Service

R&S Support	Selftest	Calibration Signal	Service Function	Hardware Diagnostics										
Create R&S Support Information		Location: C:/ES-MAIN/etv/SW/user/												
In case of problems, please write an email with the error description, attach the Support Information file and send the email to the Rohde&Schwarz Support Center.														
Save Device Footprint		Location: C:/ES-MAIN/etv/SW/devicedata/XML/												
Contact Information														
<table style="width: 100%; border-collapse: collapse;"> <tr> <td style="border-bottom: 1px solid #ccc; padding: 2px;">Customer Support Europe, Africa, Middle East:</td> <td style="border-bottom: 1px solid #ccc; padding: 2px;">Phone#0095ff 4129 12345 customersupport@rohde-schwarz.com</td> </tr> <tr> <td style="border-bottom: 1px solid #ccc; padding: 2px;">Customer Support North America:</td> <td style="border-bottom: 1px solid #ccc; padding: 2px;">Phone#0095ffTEST-RSA (1-888-837-8772) customer.support@rsa.rohde-schwarz.com</td> </tr> <tr> <td style="border-bottom: 1px solid #ccc; padding: 2px;">Customer Support Latin America:</td> <td style="border-bottom: 1px solid #ccc; padding: 2px;">Phone#0095ff-910-7988 customersupport.la@rohde-schwarz.com</td> </tr> <tr> <td style="border-bottom: 1px solid #ccc; padding: 2px;">Customer Support Asia/Pacific:</td> <td style="border-bottom: 1px solid #ccc; padding: 2px;">Phone#0095ff 13 04 88 customersupport.asia@rohde-schwarz.com</td> </tr> <tr> <td style="padding: 2px;">Customer Support China:</td> <td style="padding: 2px;">Phone#0095ff0-810-8228 / +86-400-650-5896 customersupport.china@rohde-schwarz.com</td> </tr> </table>					Customer Support Europe, Africa, Middle East:	Phone#0095ff 4129 12345 customersupport@rohde-schwarz.com	Customer Support North America:	Phone#0095ffTEST-RSA (1-888-837-8772) customer.support@rsa.rohde-schwarz.com	Customer Support Latin America:	Phone#0095ff-910-7988 customersupport.la@rohde-schwarz.com	Customer Support Asia/Pacific:	Phone#0095ff 13 04 88 customersupport.asia@rohde-schwarz.com	Customer Support China:	Phone#0095ff0-810-8228 / +86-400-650-5896 customersupport.china@rohde-schwarz.com
Customer Support Europe, Africa, Middle East:	Phone#0095ff 4129 12345 customersupport@rohde-schwarz.com													
Customer Support North America:	Phone#0095ffTEST-RSA (1-888-837-8772) customer.support@rsa.rohde-schwarz.com													
Customer Support Latin America:	Phone#0095ff-910-7988 customersupport.la@rohde-schwarz.com													
Customer Support Asia/Pacific:	Phone#0095ff 13 04 88 customersupport.asia@rohde-schwarz.com													
Customer Support China:	Phone#0095ff0-810-8228 / +86-400-650-5896 customersupport.china@rohde-schwarz.com													

- [Create R&S Support Information](#) 148
- [Save Device Footprint](#) 149

Create R&S Support Information

Creates a *.zip file with important support information. The *.zip file contains the system configuration information ("Device Footprint"), the current eeprom data and a screenshot of the screen display.

This data is stored to the C:\Users\Public\Documents\Rohde-Schwarz\Analyzer directory on the instrument.

The file name consists of the unique device ID and the current date and time of the file creation.

If you contact the Rohde & Schwarz support to get help for a certain problem, send these files to the support in order to identify and solve the problem faster.

Remote command:

[DIAGnostic:SERvice:SINFo?](#) on page 913

Save Device Footprint

Creates an *.xml file with information on installed hardware, software, image and FPGA versions. The *.xml file is stored under

C:\ProgramData\Rohde-Schwarz\ZNL-FPL\devicedata\xml\ on the instrument. It is also included in the service ZIP file (see " [Create R&S Support Information](#) " on page 148).

7.3.5.2 Self-test Settings and Results

Access: [Setup] > "Service" > "Selftest"

If the R&S FPL1000 fails you can perform a self-test of the instrument to identify any defective modules.

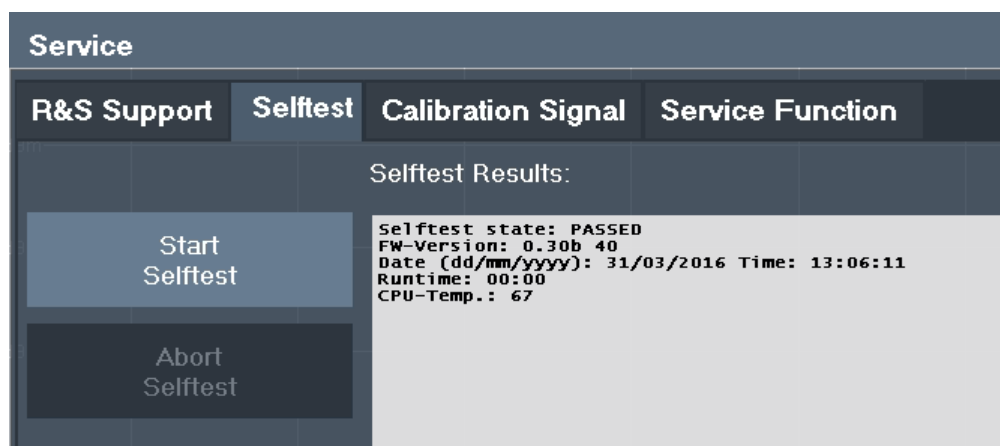

Once the self-test is started, all modules are checked consecutively and the test result is displayed. You can abort a running test.

In case of failure a short description of the failed test, the defective module, the associated value range and the corresponding test results are indicated.



A running Sequencer process is aborted when you start a self-test.

If you start a self-test remotely, then select the "Local" softkey while the test is still running, the instrument only returns to the manual operation state after the test is completed. In this case, the self-test cannot be aborted.

Remote command:

[*TST?](#) on page 578

[DIAGnostic:SERvice:STEST:RESult?](#) on page 894

7.3.5.3 Calibration Signal Display

Access: [Setup] > "Service" > "Calibration Signal"

Alternatively to the RF input signal from the front panel connector you can use the instrument's calibration signal as the input signal, for example to perform service functions on.

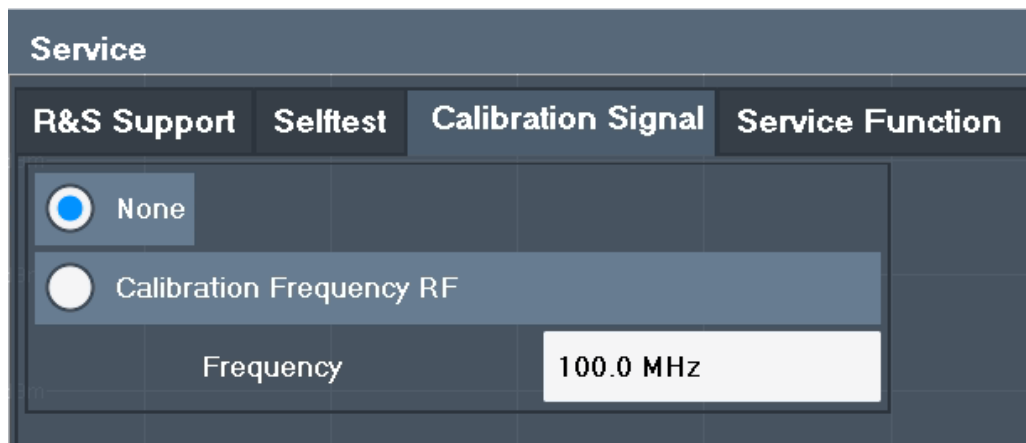

NONE	150
Calibration Frequency RF	150
L Frequency	150

NONE

Uses the current RF signal at the input, i.e. no calibration signal (default).

Remote command:

[DIAGnostic:SERVice:INPut\[:SElect\]](#) on page 894

Calibration Frequency RF

Uses the internal calibration signal as the RF input signal.

Remote command:

[DIAGnostic:SERVice:INPut\[:SElect\]](#) on page 894

[DIAGnostic:SERVice:INPut:PULSed:CFrequency](#) on page 892

Frequency ← Calibration Frequency RF

Defines the frequency of the internal broadband calibration signal to be used for IF filter calibration (max. 64 MHz).

7.3.5.4 Service Functions

Access: [Setup] > "Service" > "Service Function"

NOTICE

Using service functions

The service functions are not necessary for normal measurement operation. Incorrect use can affect correct operation and/or data integrity of the R&S FPL1000.

Therefore, only user accounts with administrator rights can use service functions and many of the functions can only be used after entering a password. These functions are described in the instrument service manual.

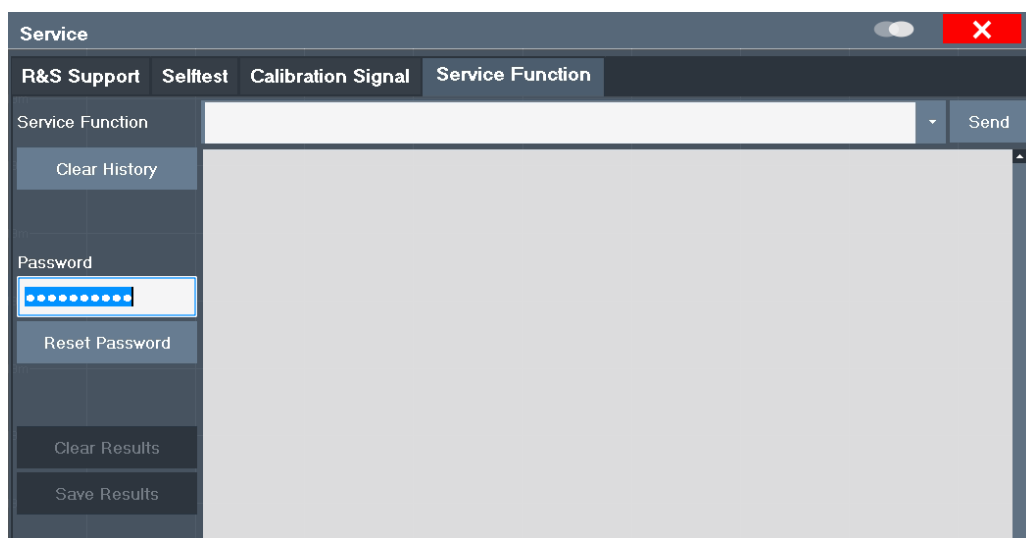

Service Function 151
 Send 151
 Clear History 151
 Password 152
 Clear Results 152
 Save Results 152
 Result List 152

Service Function

Selects the service function by its numeric code or textual name.

The selection list includes all functions previously selected (since the last "Clear History" action).

Remote command:

`DIAGnostic:SERVice:SFUNction` on page 912

Send

Starts the selected service function.

Remote command:

`DIAGnostic:SERVice:SFUNction` on page 912

Clear History

Deletes the list of previously selected service functions.

Password

Most service functions require a special password as they may disrupt normal operation of the R&S FPL1000. There are different levels of service functions, depending on how restrictive their use is handled. Each service level has a different password.

"Reset Password" clears any previously entered password and returns to the most restrictive service level.

Remote command:

`SYSTem:PASSword[:CENable]` on page 913

`SYSTem:PASSword:RESet` on page 914

Clear Results

Clears the result display for all previously performed service functions.

Remote command:

`DIAGnostic:SERVice:SFUNction:RESults:DElete` on page 913

Save Results

Opens a file selection dialog box to save the results of all previously performed service functions to a file.

Remote command:

`DIAGnostic:SERVice:SFUNction:RESults:SAVE` on page 913

Result List

The Results List indicates the status and results of the executed service functions.

7.3.6 Transducers

7.3.6.1 Basics on Transducer Factors

The transducer allows you to manipulate the trace at discrete trace points to correct the signal coming from an input device. Transducers are often used to correct the frequency response for antennas, for example. The transducer is configured by defining transducer factors for specific trace points. A set of transducer factors defines an interpolated transducer line and can be stored on the instrument.

In the Spectrum application, the correction factor from all active transducers is calculated for each displayed trace point once in advance and is added to the result of the level measurement during the sweep. If the sweep range changes, the correction values are calculated again. If several measured values are combined in one point, only one value is taken into consideration. If the active transducer line is not defined for the entire sweep range, the missing values are replaced by zeroes.

When a transducer is used, the trace is shifted by a calculated factor. However, an upward shift reduces the dynamic range for the displayed values. Thus, the reference level can be adapted automatically to restore the original dynamic range. The reference level is shifted by the maximum transducer factor. By default, if transducers are active the reference level function is adapted automatically to obtain the best dynamic performance.

If a transducer factor is active, "TDF" is displayed in the channel bar.

Y-Axis Unit

The individual transducer factors can be defined as absolute values or relative (dB) values. However, all factors for one transducer line use the same unit. As soon as a transducer is activated, the unit of the transducer is automatically used for all the level settings and outputs. The unit cannot be changed in the amplitude settings since the R&S FPL1000 and the active transducer are regarded as one measuring instrument. Only for relative transducer factors (unit dB), the unit originally set on the instrument is maintained and can be changed.

When all transducers have been switched off, the R&S FPL1000 returns to the unit that was used before a transducer was activated.

Configuration

The R&S FPL1000 supports transducer lines with a maximum of 1001 data points. Eight of the transducer lines stored in the instrument can be activated simultaneously. The number of transducer lines stored in the instrument is only limited by the capacity of the storage device used.

A transducer line consists of the following data:

- A maximum of 1001 data points with a position and value
- A unit for the values
- A name to distinguish the transducer lines

Validity

The transducer factors must comply with the following rules to ensure correct operation:

- The frequencies for the data points must always be defined in ascending order. Otherwise the entry will not be accepted and an error message is displayed.
- The frequencies of the data points may exceed the valid frequency range of the R&S FPL1000 since only the set frequency range is taken into account for measurements. The minimum frequency of a data point is 0 Hz, the maximum frequency 200 GHz.
- The value range for the transducer factor is ± 200 dB.
- Gain has to be entered as a negative value, and attenuation as a positive value.

Storing transducer factors

Transducer factors can also be stored with the configuration settings so they can be recalled for other measurements at a later time. Note, however, that any changes made to the transducer factors *after* storing the configuration file cannot be restored and will be overwritten by the stored values when the configuration file is recalled. Always remember to store the settings again after changing the transducer factors.

(See [Chapter 7.2.2, "Storing and Recalling Instrument Settings and Measurement Data"](#), on page 102).



Recalling transducer factors stored with measurement settings

After recalling measurement settings, the transducer factors applied to the measurement may be different to those displayed in the "Transducer" dialog box; see ["Saving and recalling transducer and limit line settings"](#) on page 104.

7.3.6.2 Transducer Settings

Access: [Setup] > "Transducer"

Up to 8 transducer lines can be activated simultaneously in the R&S FPL1000. Many more can be stored on the instrument.



Stored transducer settings

When storing and recalling transducer settings, consider the information provided in ["Saving and recalling transducer and limit line settings"](#) on page 104.

- [Transducer Management](#)..... 154
- [Transducer Factors](#)..... 156

Transducer Management

Access: [Setup] > "Transducer"

The settings required to manage all transducer lines on the instrument are described here.

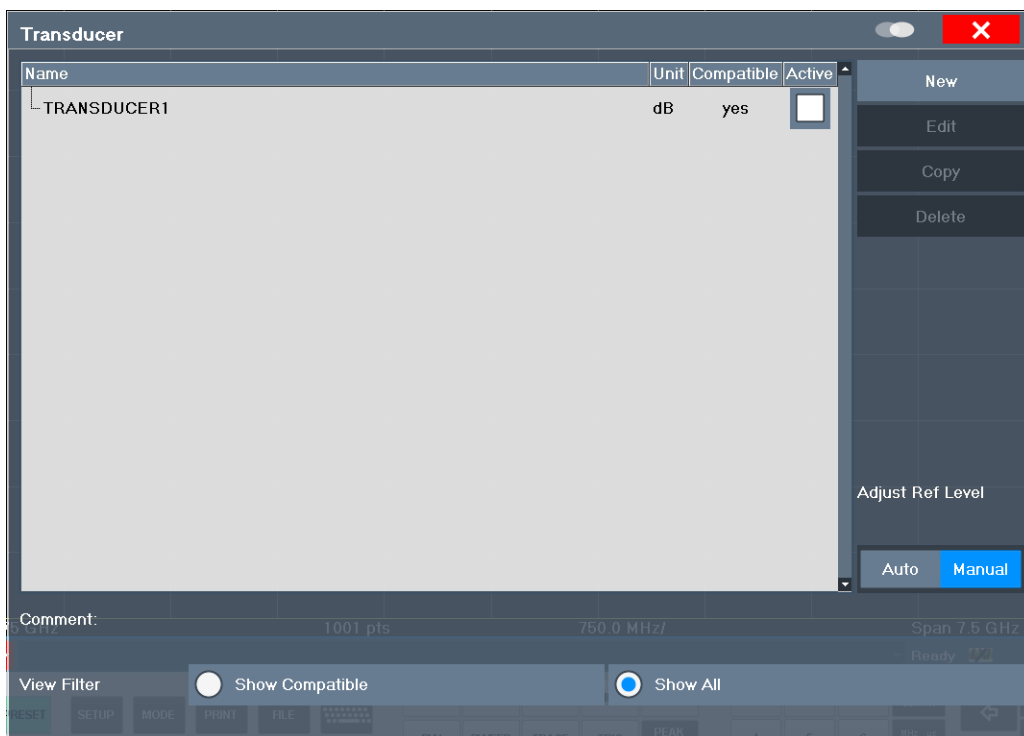

For the transducer line overview, the R&S FPL1000 searches for all stored transducer lines with the file extension `.TDF` in the

`C:\ProgramData\Rohde-Schwarz\ZNL-FPL\trd` directory. The overview allows you to determine which transducer lines are available and can be used for the current measurement.

For details on settings for individual lines see ["Transducer Factors"](#) on page 156.

For instructions on configuring and working with transducers see [Chapter 7.3.6.4, "How to Configure the Transducer"](#), on page 160.

Name	155
Unit	155
Compatibility	155
Activating / Deactivating	155
Comment	156
Included Transducer Lines in Overview (View Filter)	156
Adjust Ref Level	156
Create New Line	156
Edit Line	156
Copy Line	156
Delete Line	156

Name

The name of the stored transducer line.

Unit

The unit in which the y-values of the data points of the transducer line are defined.

The following units are available:

- dB
- dBm
- dBmV
- dB μ V
- dB μ V/m
- dB μ A
- dB μ A/m
- dBpW
- dBpT

Compatibility

Indicates whether the transducer factors are compatible with the current measurement settings.

For more information on which conditions a transducer line must fulfill to be compatible, see [Chapter 7.3.6.1, "Basics on Transducer Factors"](#), on page 152.

Activating / Deactivating

Activates/deactivates the transducer line. Up to 8 transducer lines can be active at the same time.

Remote command:

[\[SENSe:\]CORRection:TRANsducer:SElect](#) on page 897

[\[SENSe:\]CORRection:TRANsducer\[:STATe\]](#) on page 897

Comment

An optional description of the transducer line.

Included Transducer Lines in Overview (View Filter)

Defines which of the stored transducer lines are included in the overview. The view can be restricted to compatible transducer lines only or include all transducer lines found. Whether a line is compatible or not is indicated in the [Compatibility](#) setting.

Adjust Ref Level

Activates or deactivates the automatic adjustment of the reference level to the selected transducer factor.

"Auto" Activates the automatic adjustment. The original dynamic range is restored by shifting the reference level by the maximum transducer factor.

"Manual" Deactivates the automatic adjustment. Adjust the reference level via the "Amplitude" menu.

Remote command:

[\[SENSe:\]CORRection:TRANsducer:ADJust:RLEVel\[:STATe\]](#) on page 895

Create New Line

Create a new transducer line.

Remote command:

[\[SENSe:\]CORRection:TRANsducer:SElect](#) on page 897

Edit Line

Edit an existing transducer line configuration.

Copy Line

Copy the selected transducer line configuration to create a new line.

Delete Line

Delete the selected transducer line.

Remote command:

[\[SENSe:\]CORRection:TRANsducer:DElete](#) on page 897

Transducer Factors

Access: [Setup] > "Transducer" > "Edit Line" / "Copy Line" / "New Line"

The settings and functions available for individual transducer lines are described here.

For instructions on creating and editing transducer lines see [Chapter 7.3.6.4, "How to Configure the Transducer"](#), on page 160.

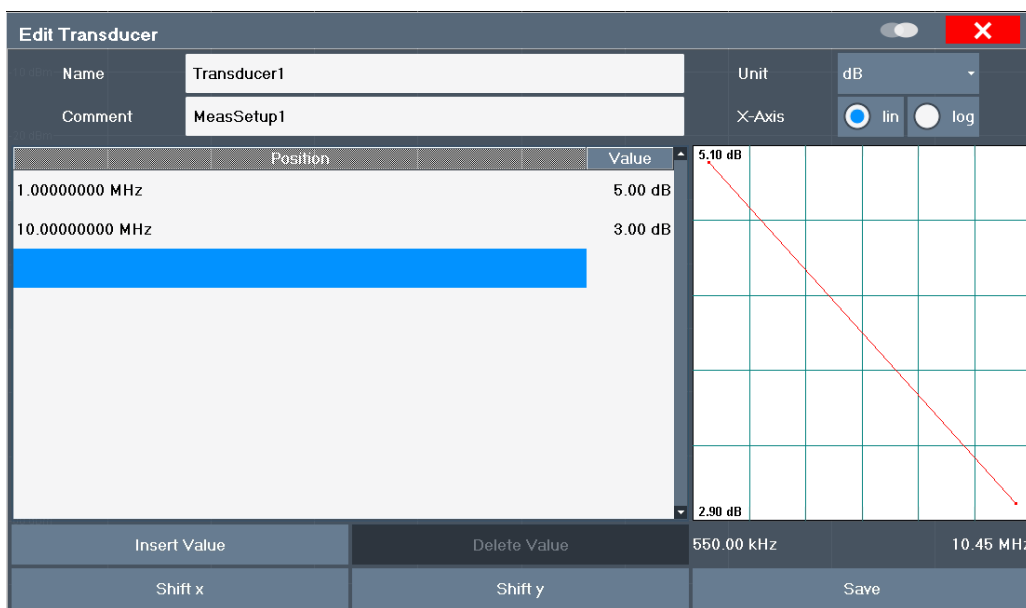

Name 157

Comment 157

Unit 157

X-Axis Scaling 158

Data Points 158

Insert Value 158

Delete Value 158

Shift x 158

Shift y 158

Save 158

Import 159

Export 159

Name

Defines the transducer line name. All names must be compatible with the Windows conventions for file names. The transducer data is stored under this name (with a .TDF extension) in the C:\ProgramData\Rohde-Schwarz\ZNL-FPL\trd directory.

Remote command:

[SENSe:]CORRection:TRANsducer:SELEct on page 897

Comment

Defines an optional comment for the transducer line. The text may contain up to 40 characters.

Remote command:

[SENSe:]CORRection:TRANsducer:COMMeNt on page 896

Unit

The unit in which the y-values of the data points of the transducer line are defined.

As soon as a transducer is activated, the unit of the transducer is automatically used for all the level settings and outputs. The unit cannot be changed in the amplitude settings unless dB is used.

Remote command:

[\[SENSe:\]CORRection:TRANsdUcer:UNIT](#) on page 898

X-Axis Scaling

Describes the scaling of the horizontal axis on which the data points of the transducer line are defined. Scaling can be linear or logarithmic.

Remote command:

[\[SENSe:\]CORRection:TRANsdUcer:SCALing](#) on page 897

Data Points

Each transducer line is defined by a minimum of 2 and a maximum of 50 data points. Each data point is defined by its position (x-axis) and value (y-value).

The data points must comply with the following rules to ensure correct operation:

- The frequencies for the data points must always be defined in ascending order. Otherwise the entry will not be accepted and an error message is displayed.
- The frequencies of the data points may exceed the valid frequency range of the R&S FPL1000 since only the set frequency range is taken into account for measurements. The minimum frequency of a data point is 0 Hz, the maximum frequency 200 GHz.
- The value range for the transducer factor is ± 200 dB.
- Gain has to be entered as a negative value, and attenuation as a positive value.

Remote command:

[\[SENSe:\]CORRection:TRANsdUcer:DATA](#) on page 896

Insert Value

Inserts a data point in the transducer line above the selected one in the "Edit Transducer" dialog box.

Delete Value

Deletes the selected data point in the "Edit Transducer" dialog box.

Shift x

Shifts the x-value of each data point horizontally by the defined shift width.

Shift y

Shifts the y-value of each data point vertically by the defined shift width.

Save

Saves the currently edited transducer line under the name defined in the "Name" field.

Remote command:

[MMEMory:SELEct\[:ITEM\]:TRANsdUcer:ALL](#) on page 871

[MMEMory:STORe<n>:STATe](#) on page 874

Import

Opens a file selection dialog box and loads the transducer factor from the selected file in .CSV format.

Note that a valid import file must contain a minimum of required information for the R&S FPL1000. For details on the file format see [Chapter 7.3.6.3, "Reference: Transducer Factor File Format"](#), on page 159.

Remote command:

`MMEMory:LOAD<n>:TFACTOR` on page 898

Export

Opens a file selection dialog box and stores the currently displayed transducer factor to the defined file in .CSV format.

For details on the file format see [Chapter 7.3.6.3, "Reference: Transducer Factor File Format"](#), on page 159.

The transducer factor can be imported again later by the R&S FPL1000 for use in other measurements.

Remote command:

`MMEMory:STORe<n>:TFACTOR` on page 898

7.3.6.3 Reference: Transducer Factor File Format

Transducer factor data can be exported to a file in ASCII (CSV) format for further evaluation in other applications. Transducer factors stored in the specified ASCII (CSV) format can also be imported to the R&S FPL1000 for other measurements.

For more information about transducer factors, see [" Import "](#) on page 159.

This reference describes in detail the format of the export/import files for transducer factors. Note that the **bold** data is **mandatory**, all other data is optional.

Different language versions of evaluation programs may require a different handling of the decimal point. Thus, you can define the decimal separator to be used (see [" Decimal Separator "](#) on page 115).

Table 7-2: ASCII file format for transducer factor files

File contents	Description
Header data	
sep= ;	Separator for individual values (required by Microsoft Excel, for example)
Type ;RS_TransducerFactor;	Type of data
FileFormatVersion ;1.00;	File format version
Date;01.Oct 2006;	Date of data set storage
OptionID;SpectrumAnalyzer	Application the transducer factor was created for
Name ;TestTDF1	Transducer factor name
Comment;Transducer for device A	Description of transducer factor

File contents	Description
XAxisScaling;LINEAR	Scaling of x-axis linear (LIN) or logarithmic (LOG)
YAxisUnit;LEVEL_DB	Unit of y values
YAxisScaleMode;ABSOLUTE	Scaling of y-axis (absolute or relative)
NoOfPoints;5	Number of points the line is defined by
Data section for individual data points	
1000000000;-50.000000	x- and y-values of each data point defining the line
5000000000;-30.000000	
10000000000;0.000000	
15000000000;-30.000000	
25000000000;-50.000000	

7.3.6.4 How to Configure the Transducer

Configuring the transducer is very similar to configuring transducer factors.

The transducer settings are defined in the "Transducer" dialog box which is displayed when you press the [Setup] key and then select "Transducer" .



Stored transducer settings

When storing and recalling transducer settings, consider the information provided in ["Saving and recalling transducer and limit line settings"](#) on page 104.

The following tasks are described:

- ["How to find compatible transducer lines"](#) on page 160
- ["How to activate and deactivate a transducer"](#) on page 160
- ["How to edit existing transducer lines"](#) on page 161
- ["How to copy an existing transducer line"](#) on page 161
- ["How to delete an existing transducer line"](#) on page 161
- ["How to configure a new transducer line"](#) on page 162
- ["How to move the transducer line vertically or horizontally"](#) on page 162

How to find compatible transducer lines

- ▶ In the "Transducer" dialog box, select the "View Filter" option: "Show Compatible" .

All transducer lines stored on the instrument that are compatible to the current measurement settings are displayed in the overview.

How to activate and deactivate a transducer

1. To activate a transducer select a transducer line in the overview and select the "Active" setting for it.

The trace is automatically recalculated for the next sweep after a transducer line is activated.

2. To deactivate a transducer line, deactivate the "Active" setting for it.
After the next sweep, the originally measured values are displayed.

How to edit existing transducer lines

Existing transducer line configurations can be edited.

1. In the "Transducer" dialog box, select the transducer line.
2. Select the "Edit" button.
3. Edit the line configuration as described in ["How to configure a new transducer line"](#) on page 162.
4. Save the new configuration by selecting the "Save" button.

The trace is automatically recalculated for the next sweep if the transducer line is active.



In order to store the changes to the transducer lines in a settings file, select the  "Save" icon in the toolbar.

(See [Chapter 7.2.2, "Storing and Recalling Instrument Settings and Measurement Data"](#), on page 102).

How to copy an existing transducer line

1. In the "Transducer" dialog box, select the transducer line.
2. Select the "Copy" button.
The "Edit Transducer" dialog box is opened with the configuration of the selected transducer.
3. Define a new name to create a new transducer with the same configuration as the source line.
4. Edit the line configuration as described in ["How to configure a new transducer line"](#) on page 162.
5. Save the new configuration by selecting the "Save" button.

The new transducer line is displayed in the overview and can be activated.

How to delete an existing transducer line

1. In the "Transducer" dialog box, select the transducer line.
2. Select the "Delete" button.
3. Confirm the message.

The transducer line is deleted. After the next sweep, the originally measured values are displayed.

How to configure a new transducer line

1. In the "Transducer" dialog box, select the "New" button.
The "Edit Transducer" dialog box is displayed. The current line configuration is displayed in the preview area of the dialog box. The preview is updated after each change to the configuration.
2. Define a "Name" and, optionally, a "Comment" for the new transducer line.
3. Define the scaling for the x-axis.
4. Define the data points: minimum 2, maximum 1000:
 - a) Select "Insert Value" .
 - b) Define the x-value ("Position") and y-value ("Value") of the first data point.
 - c) Select "Insert Value" again and define the second data point.
 - d) Repeat this to insert all other data points.
To insert a data point before an existing one, select the data point and then "Insert Value" .
To insert a new data point at the end of the list, move the focus to the line after the last entry and then select "Insert Value" .
To delete a data point, select the entry and then "Delete Value" .
5. Check the current line configuration in the preview area of the dialog box. If necessary, correct individual data points or add or delete some.
If necessary, shift the entire line vertically or horizontally by selecting the "Shift x" or "Shift y" button and defining the shift width.
6. Save the new configuration by selecting the "Save" button.
The new transducer line is displayed in the overview and can be activated.

How to move the transducer line vertically or horizontally

A configured transducer line can easily be moved vertically or horizontally. Thus, a new transducer line can be easily generated based upon an existing transducer line which has been shifted.

1. In the "Line Config" dialog box, select the transducer line.
2. Select the "Edit" button.
3. In the "Edit Transducer Line" dialog box, select the "Shift x" or "Shift y" button and define the shift width.
4. Save the shifted data points by selecting the "Save" button.
If activated, the trace is recalculated after the next sweep.

7.3.7 Alignment

7.3.7.1 Basics on Alignment

When you put the instrument into operation for the first time or when strong temperature changes occur, align the data to a reference source (see ["Temperature check"](#) on page 163).

The correction data and characteristics required for the alignment are determined by the firmware. It compares the results at different settings with the known characteristics of the high-precision calibration signal source at 64 MHz.



During instrument start, the firmware checks whether the installed hardware is supported. If not, an error message is displayed ("Wrong Firmware Version") and you are asked to update the firmware. Until the firmware version is updated, self-alignment fails.



If you start a self-alignment remotely and then select the "Local" softkey while the alignment is still running, the instrument only returns to the manual operation state after the alignment is completed.

Alignment results

The alignment results are displayed and contain the following information:

- Date and time of last correction data record
- Overall results of correction data record
- List of found correction values according to function/module

The results are classified as follows:

PASSED	Calibration successful without any restrictions
CHECK	Deviation of correction value larger than expected, correction could however be performed
FAILED	Deviations of correction value too large, no correction was possible. The found correction data is not applicable.

The results are available until the next self-alignment process is started or the instrument is switched off.

Temperature check

During self-alignment, the instrument's (frontend) temperature is also measured (as soon as the instrument has warmed up completely). This temperature is used as a reference for a continuous temperature check during operation. If the current temperature deviates from the stored self-alignment temperature by a certain degree, a warning is displayed in the status bar. The warning indicates the resulting deviation in the measured power levels. A status bit in the `STATUS:QUESTIONABLE:TEMPERATURE` regis-

ter indicates a possible deviation. The current temperature of the RF frontend can be queried using a remote command (see `SOURCE<si>:TEMPerature:FRONTend` on page 894).

Touchscreen alignment

When the device is delivered, the touchscreen is initially calibrated. However, to ensure that the touchscreen responds to the finger contact correctly, a touchscreen alignment is required.

Alignment of the touchscreen is useful:

- At first use
- After an image update or after exchanging a hard disk
- If you notice that touching a specific point on the screen does not achieve the correct response
- If the position of the instrument has been changed and you cannot look straight on the screen
- If another person operates the instrument

7.3.7.2 Alignment Settings

Access: [Setup] > "Alignment"

Both the instrument and the touchscreen can be aligned when necessary (see [Chapter 7.3.7.1, "Basics on Alignment"](#), on page 163).

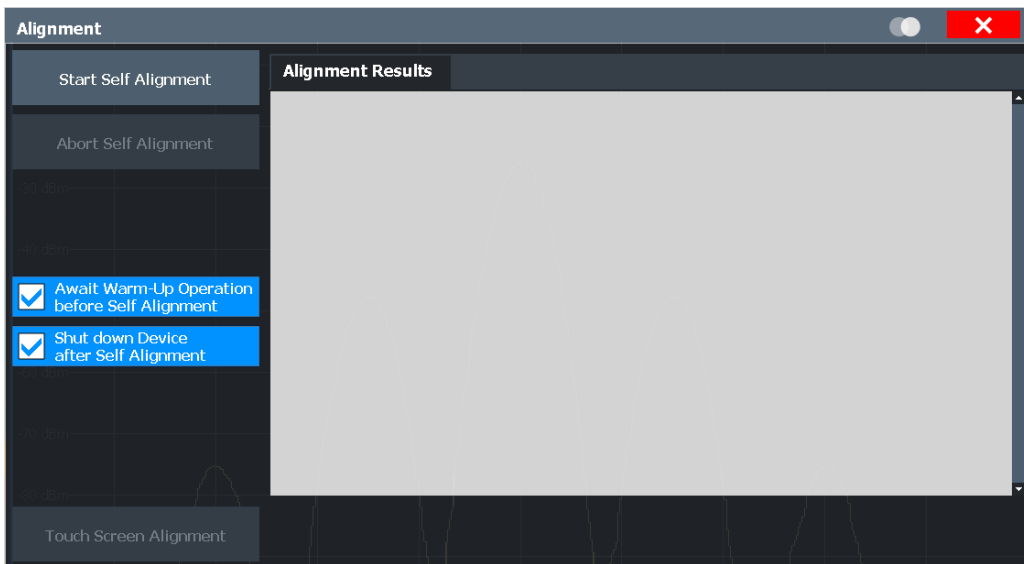

Start Self Alignment 165

Abort Self Alignment 165

Await Warm-Up Operation before Self Alignment..... 165

Shut down Device after Self Alignment..... 165

Starting Touch Screen Alignment 165

Alignment Results: 165

Start Self Alignment

Starts recording correction data for the instrument. If the correction data acquisition fails or if the correction values are deactivated, a corresponding message is displayed in the status field.

For details, see [Chapter 7.3.7.1, "Basics on Alignment"](#), on page 163.

Note:

A running Sequencer operation is aborted when you start a self-alignment.

Remote command:

*CAL? on page 575, see also [CALibration\[:ALL\]](#) on page 891

Abort Self Alignment

As long as the self-alignment data is being collected, the procedure can be canceled using the "Abort Self Alignment" button.

Note: If you start a self-alignment remotely, then select the "Local" softkey while the alignment is still running, the instrument only returns to the manual operation state after the alignment is completed. In this case, you cannot abort a self-alignment manually.

Await Warm-Up Operation before Self Alignment

Displays a message indicating the remaining warmup time required before self-alignment is performed. After the warmup operation has completed, self-alignment is started automatically.

Shut down Device after Self Alignment

If activated, the R&S FPL1000 is automatically shut down after self-alignment is completed. Note that the instrument cannot be restarted via remote control.

Starting Touch Screen Alignment

Starts the touchscreen alignment.

Tap the 4 markers on the screen as you are asked to do. The touchscreen is aligned according to the executed pointing operations.

Alignment Results:

Information on whether the alignment was performed successfully and on the applied correction data is displayed. The results are available until the next self-alignment process is started or the instrument is switched off.

Remote command:

[CALibration:RESult?](#) on page 892

7.3.7.3 How to Perform a Self-Test

You do not have to repeat the self-test every time you switch on the instrument. It is only necessary when instrument malfunction is suspected.

**Operating temperature**

Before performing this functional test, make sure that the instrument has reached its operating temperature (for details, refer to the data sheet).

1. Press the [SETUP] key.
2. Press the "Service" softkey.
3. Press the "Selftest" softkey.

Once the instrument modules have been checked successfully, a message is displayed.

7.3.7.4 How to Align the Instrument**Operating temperature**

Before performing this functional test, make sure that the instrument has reached its operating temperature (for details, refer to the data sheet).

To perform a self-alignment

1. Press the [SETUP] key.
2. Select the "Alignment" softkey.
3. Select the "Start Self Alignment" button.
4. To abort the self-alignment process, select the "Abort Self Alignment" button.

Once the system correction values have been calculated successfully, a message is displayed.

**To display the alignment results again later**

- Press the [SETUP] key.
- Press the "Alignment" softkey.

7.3.7.5 How to Align the Touchscreen**To align the touchscreen**

1. Press the [Setup] key.
2. Select the "Alignment" softkey.
3. Select "Touch Screen Alignment" .

A blinking cross appears in the lower left corner of the screen.

4. Touch and hold the blinking cross until it stops blinking.
Repeat this action for the crosses in the other corners.

7.4 Network and Remote Operation

In addition to working with the R&S FPL1000 interactively, located directly at the instrument, it is also possible to operate and control it from a remote PC. Various methods for remote control are supported:

- Connecting the instrument to a (LAN) network
- Using the LXI browser interface in a LAN network
- Using the Windows Remote Desktop application in a LAN network
- Connecting a PC via the GPIB interface

How to configure the remote control interfaces is described in [Chapter 7.4.4, "How to Set Up a Network and Remote Control"](#), on page 218.

• Remote Control Basics	167
• GPIB Languages	204
• Network and Remote Control Settings	206
• How to Set Up a Network and Remote Control	218

7.4.1 Remote Control Basics

Basic information on operating an instrument via remote control is provided here. This information applies to all applications and operating modes on the R&S FPL1000.



For additional information on remote control of spectrum analyzers see the following application notes available from the Rohde & Schwarz website:

- [1EF62: Hints and Tricks for Remote Control of Spectrum and Network Analyzers](#)
- [1MA171: How to use Rohde & Schwarz Instruments in MATLAB](#)
- [1MA208: Fast Remote Instrument Control with HiSLIP](#)

• Remote Control Interfaces and Protocols	168
• SCPI (Standard Commands for Programmable Instruments)	175
• VISA Libraries	176
• Messages	176
• SCPI Command Structure	177
• Command Sequence and Synchronization	185
• Status Reporting System	187
• General Programming Recommendations	203

7.4.1.1 Remote Control Interfaces and Protocols

The instrument supports different interfaces and protocols for remote control. The following table gives an overview.

Table 7-3: Remote control interfaces and protocols

Interface	Protocols, VISA ^{*)} address string	Remarks
Local Area Network (LAN)	<ul style="list-style-type: none"> • HiSLIP High-Speed LAN Instrument Protocol (IVI-6.1) TCPIP::host address::hislip0[::INSTR] • VXI-11 TCPIP::host address::inst0[::INSTR] Library: VISA • socket communication (Raw Ethernet, simple Telnet) TCPIP::host address[::LAN device name]::<port>::SOCKET Library: VISA or socket controller 	<p>A LAN connector is located on the rear panel of the instrument.</p> <p>The interface is based on TCP/IP and supports various protocols.</p> <p>For a description of the protocols refer to:</p> <p>VXI-11 Protocol</p> <p>HiSLIP Protocol</p> <p>Socket Communication</p>
GPIB (IEC/IEEE Bus Interface)	<p>VISA^{*)} address string:</p> <p>GPIB::primary address[::INSTR]</p> <p>(no secondary address)</p>	<p>An optional GPIB bus interface according to the IEC 625.1/IEEE 488.1 standard is located on the rear panel of the instrument.</p> <p>For a description of the interface refer to GPIB Interface (IEC 625/IEEE 418 Bus Interface).</p>
<p>^{*)} VISA is a standardized software interface library providing input and output functions to communicate with instruments. A VISA installation on the controller is a prerequisite for remote control using the indicated interfaces.</p> <p>(See also Chapter 7.4.1.3, "VISA Libraries", on page 176).</p>		



Within this interface description, the term GPIB is used as a synonym for the IEC/IEEE bus interface.

LAN Interface

To be integrated in a LAN, the instrument is equipped with a LAN interface, consisting of a connector, a network interface card and protocols. The network card can be operated with the following interfaces:

- 10 Mbit/s Ethernet IEEE 802.3
- 100 Mbit/s Ethernet IEEE 802.3u
- 1Gbit/s Ethernet IEEE 802.3ab

For remote control via a network, the PC and the instrument must be connected via the LAN interface to a common network with TCP/IP network protocol. They are connected using a commercial RJ45 cable (shielded or unshielded twisted pair category 5). The TCP/IP network protocol and the associated network services are preconfigured on the instrument. Software for instrument control and the VISA program library must be installed on the controller.

VISA library

Instrument access is usually achieved from high level programming platforms using VISA as an intermediate abstraction layer. VISA encapsulates the low level VXI, GPIB, LAN or USB function calls and thus makes the transport interface transparent for the user. See [Chapter 7.4.1.3, "VISA Libraries"](#), on page 176 for details.

The R&S FPL1000 supports various LAN protocols such as LXI, RSIB, raw socket or the newer HiSLIP protocol.

IP address

Only the IP address or a valid DNS host name is required to set up the connection. The host address is part of the "VISA resource string" used by the programs to identify and control the instrument.

The VISA resource string has the form:

```
TCPIP::host address[::LAN device name][::INSTR]
```

or

```
TCPIP::host address::port::SOCKET
```

where:

- **TCPIP** designates the network protocol used
- **host address** is the IP address or host name of the device
- **LAN device name** defines the protocol and the instance number of a sub-instrument;
 - `inst0` selects the VXI-11 protocol (default)
 - `hislip0` selects the newer HiSLIP protocol
- **INSTR** indicates the instrument resource class (optional)
- **port** determines the used port number
- **SOCKET** indicates the raw network socket resource class

Example:

- Instrument has the IP address *192.1.2.3*; the valid resource string using VXI-11 protocol is:

```
TCPIP::192.1.2.3::INSTR
```
- The DNS host name is *FPL1004-123456*; the valid resource string using HiSLIP is:

```
TCPIP::FPL1004-123456::hislip0
```
- A raw socket connection can be established using:

```
TCPIP::192.1.2.3::5025::SOCKET
```



Identifying instruments in a network

If several instruments are connected to the network, each instrument has its own IP address and associated resource string. The controller identifies these instruments by means of the resource string.

For details on configuring the LAN connection, see [Chapter 7.4.4.1, "How to Configure a Network"](#), on page 218.

• VXI-11 Protocol	170
• HiSLIP Protocol	170
• Socket Communication	170
• LXI Web Browser Interface	171

VXI-11 Protocol

The VXI-11 standard is based on the ONC RPC (Open Network Computing Remote Procedure Call) protocol which in turn relies on TCP/IP as the network/transport layer. The TCP/IP network protocol and the associated network services are preconfigured. TCP/IP ensures connection-oriented communication, where the order of the exchanged messages is adhered to and interrupted links are identified. With this protocol, messages cannot be lost.

HiSLIP Protocol

The HiSLIP (**H**igh **S**peed **L**AN **I**nstrument **P**rotocol) is the successor protocol for VXI-11 for TCP-based instruments specified by the IVI foundation. The protocol uses two TCP sockets for a single connection - one for fast data transfer, the other for non-sequential control commands (e.g. `Device Clear` or `SRQ`).

HiSLIP has the following characteristics:

- High performance as with raw socket network connections
- Compatible IEEE 488.2 support for Message Exchange Protocol, Device Clear, Serial Poll, Remote/Local, Trigger, and Service Request
- Uses a single IANA registered port (4880), which simplifies the configuration of fire-walls
- Supports simultaneous access of multiple users by providing versatile locking mechanisms
- Usable for IPv6 or IPv4 networks



Using VXI-11, each operation is blocked until a VXI-11 device handshake returns. However, using HiSLIP, data is sent to the device using the "fire and forget" method with immediate return. Thus, a successful return of a VISA operation such as `viWrite()` does not guarantee that the instrument has finished or started the requested command, but is delivered to the TCP/IP buffers.

For more information see also the application note:

[1MA208: Fast Remote Instrument Control with HiSLIP](#)

Socket Communication

An alternative way for remote control of the software is to establish a simple network communication using sockets. The socket communication, also referred to as "Raw Ethernet communication", does not necessarily require a VISA installation on the remote controller side. It is available by default on all operating systems.

The simplest way to establish socket communication is to use the built-in telnet program. The telnet program is part of every operating system and supports a communication with the software on a command-by-command basis. For more convenience and to enable automation by means of programs, user-defined sockets can be programmed.

Socket connections are established on a specially defined port. The socket address is a combination of the IP address or the host name of the instrument and the number of the port configured for remote-control. All R&S FPL1000 use port number 5025 for this purpose. The port is configured for communication on a command-to-command basis and for remote control from a program.

LXI Web Browser Interface

LAN eXtensions for Instrumentation (LXI) is an instrumentation platform for measuring instruments and test systems that is based on standard Ethernet technology. LXI is intended to be the LAN-based successor to GPIB, combining the advantages of Ethernet with the simplicity and familiarity of GPIB. The LXI browser interface allows for easy configuration of the LAN and remote control of the R&S FPL1000 without additional installation requirements.

The instrument's LXI web browser interface works correctly with all W3C compliant browsers.

Via the LXI browser interface to the R&S FPL1000 you can control the instrument remotely from another PC. Manual instrument controls are available via the front panel simulation. File upload and download between the instrument and the remote PC is also available. Using this feature, several users can access *and operate* the R&S FPL1000 simultaneously. This is useful for troubleshooting or training purposes.

For details, see ["How to Configure the LAN Using the LXI Web Browser Interface"](#) on page 222 and [Chapter 7.4.4.5, "How to Control the R&S FPL1000 via the Web Browser Interface"](#), on page 227.



If you do not want other users in the LAN to be able to access and operate the R&S FPL1000 you can deactivate this function.

See [Chapter 7.4.4.6, "How to Deactivate the Web Browser Interface"](#), on page 228.

To display the LXI web browser interface

- ▶ In the address field of the browser on your PC, type the host name or IP address of the instrument, for example: `http://10.113.10.203`.

The instrument home page (welcome page) opens.

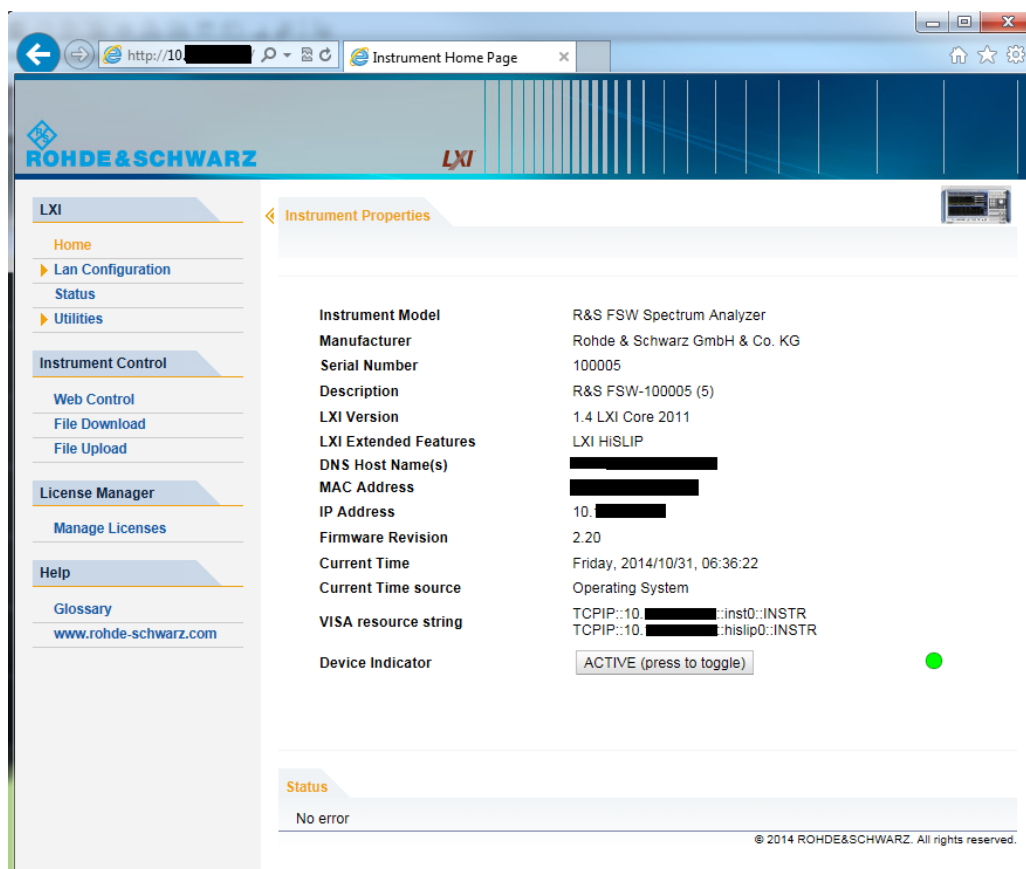

The navigation pane of the browser interface contains the following elements:

- "LXI"
 - "Home" opens the instrument home page.
The home page displays the device information required by the LXI standard, including the VISA resource string in read-only format.
The "Device Indicator" button allows you to physically identify the instrument. This is useful if you have several instruments and want to know which instrument the LXI home page belongs to. To identify the instrument, activate the "Device Indicator" . Then check the "LAN Status" indicator of the instruments.
 - "LAN Configuration" allows you to configure LAN parameters and to initiate a ping.
(See ["Ping Client"](#) on page 224.)
(See
 - "Status Bar" displays information about the LXI status of the instrument.
 - "Utilities" provides access to the LXI event log functionality required by the LXI standard.
- "Instrument Control"
 - "Web Control" provides remote access to the instrument via VNC (no installation required). Manual instrument controls are available via the front panel simulation.
 - "File Download" downloads files from the instrument.

- "File Upload" uploads files to the instrument.

(See [Chapter 7.4.4.5, "How to Control the R&S FPL1000 via the Web Browser Interface"](#), on page 227.)

- "License Manager"
 - "License Manager" allows you to install or uninstall license keys and to activate, register or unregister licenses.
- "Help"
 - "Glossary" explains terms related to the LXI standard.
 - "www.rohde-schwarz.com" opens the Rohde & Schwarz home page.

GPIB Interface (IEC 625/IEEE 418 Bus Interface)

An optional GPIB interface can be integrated on the rear panel of the instrument.

By connecting a PC to the R&S FPL1000 via the GPIB connection you can send remote commands to control and operate the instrument.

To be able to control the instrument via the GPIB bus, the instrument and the controller must be linked by a GPIB bus cable. A GPIB bus card, the card drivers and the program libraries for the programming language used must be provided in the controller. The controller must address the instrument with the GPIB bus address (see ["How to Change the GPIB Instrument Address"](#) on page 224). You can set the GPIB address and the ID response string. The GPIB language is set as SCPI by default and cannot be changed for the R&S FPL1000.

Notes and Conditions

In connection with the GPIB interface, note the following:

- Up to 15 instruments can be connected
- The total cable length is restricted to a maximum of 15 m or 2 m times the number of devices, whichever is less; the cable length between two instruments should not exceed 2 m.
- A wired "OR"-connection is used if several instruments are connected in parallel.
- Any connected IEC-bus cables should be terminated by an instrument or controller.

GPIB Interface Messages

Interface messages are transmitted to the instrument on the data lines, with the attention line (ATN) being active (LOW). They are used for communication between the controller and the instrument and can only be sent by a computer which has the function of a GPIB bus controller. GPIB interface messages can be further subdivided into:

- **Universal commands:** act on all instruments connected to the GPIB bus without previous addressing
- **Addressed commands:** only act on instruments previously addressed as listeners

The following figure provides an overview of the available communication lines used by the GPIB interface.

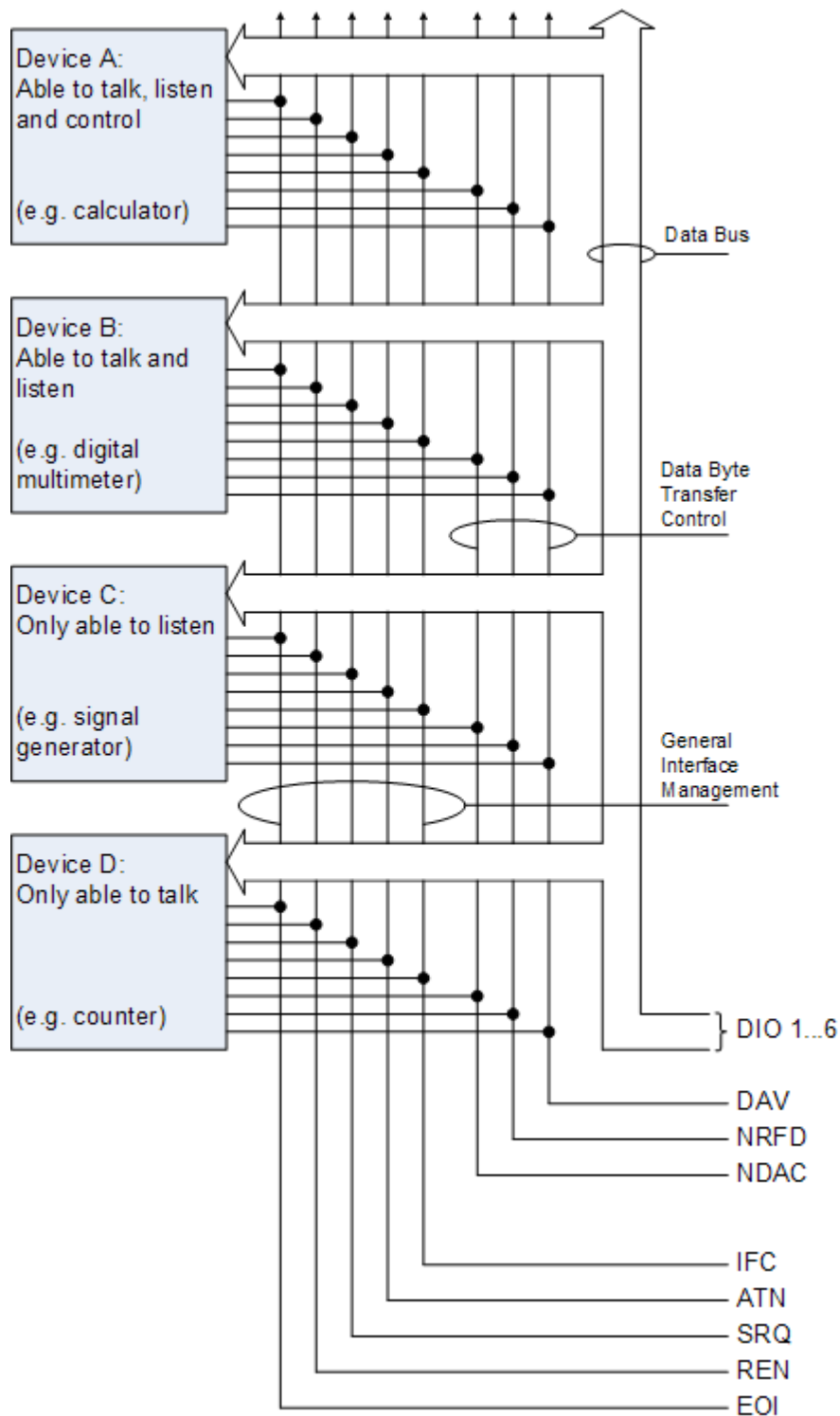

Figure 7-1: Communication lines used by the GPIB interface

Universal Commands

Universal commands are encoded in the range 10 through 1F hex. They affect all instruments connected to the bus and do not require addressing.

Command	Effect on the instrument
DCL (Device Clear)	Aborts the processing of the commands just received and sets the command processing software to a defined initial state. Does not change the instrument settings.
IFC (Interface Clear *)	Resets the interfaces to the default setting.
LLO (Local Lockout)	The "Local" softkey is disabled. Manual operation is no longer available until <i>GTL</i> is executed.
SPE (Serial Poll Enable)	Ready for serial poll.
SPD (Serial Poll Disable)	End of serial poll.
PPU (Parallel Poll Unconfigure)	End of the parallel-poll state.
*) IFC is not a real universal command, it is sent via a separate line; however, it also affects all instruments connected to the bus and does not require addressing	

Addressed Commands

Addressed commands are encoded in the range 00 through 0F hex. They only affect instruments addressed as listeners.

Command	Effect on the instrument
GET (Group Execute Trigger)	Triggers a previously active instrument function (e.g. a sweep). The effect of the command is the same as with that of a pulse at the external trigger signal input.
GTL (Go to Local)	Transition to the "local" state (manual control).
GTR (Go to Remote)	Transition to the "remote" state (remote control).
PPC (Parallel Poll Configure)	Configures the instrument for parallel poll.
SDC (Selected Device Clear)	Aborts the processing of the commands just received and sets the command processing software to a defined initial state. Does not change the instrument setting.

7.4.1.2 SCPI (Standard Commands for Programmable Instruments)

SCPI commands - messages - are used for remote control. Commands that are not taken from the SCPI standard follow the SCPI syntax rules. The R&S FPL1000 supports the SCPI version 1999. The SCPI standard is based on standard IEEE 488.2 and aims at the standardization of device-specific commands, error handling and the status registers. The tutorial "Automatic Measurement Control - A tutorial on SCPI and IEEE 488.2" from John M. Pieper (R&S order number 0002.3536.00) offers detailed information on concepts and definitions of SCPI.

Tables provide a fast overview of the bit assignment in the status registers. The tables are supplemented by a comprehensive description of the status registers.

7.4.1.3 VISA Libraries

VISA is a standardized software interface library providing input and output functions to communicate with instruments. The I/O channel (LAN or TCP/IP, USB, ...) is selected at initialization time by one of the following:

- The channel-specific address string ("VISA resource string") indicated in [Table 7-3](#)
- An appropriately defined VISA alias (short name).

A VISA installation is a prerequisite for remote control using the following interfaces:

- "[GPIB Interface \(IEC 625/IEEE 418 Bus Interface\)](#)" on page 173
- "[LAN Interface](#)" on page 168

For more information about VISA, refer to the user documentation.

7.4.1.4 Messages

The messages transferred on the data lines are divided into the following categories:

- **Interface messages**
Interface messages are transmitted to the instrument on the data lines, with the attention line being active (LOW). They are used to communicate between the controller and the instrument. Interface messages can only be sent by instruments that have GPIB bus functionality. For details see the sections for the required interface.
- **Instrument messages**
Instrument messages are employed in the same way for all interfaces, if not indicated otherwise in the description. Structure and syntax of the instrument messages are described in [Chapter 7.4.1.5, "SCPI Command Structure"](#), on page 177. A detailed description of all messages available for the instrument is provided in the chapter "Remote Control Commands".
There are different types of instrument messages, depending on the direction they are sent:
 - Commands
 - Instrument responses

Commands

Commands (program messages) are messages the controller sends to the instrument. They operate the instrument functions and request information. The commands are subdivided according to two criteria:

- According to the effect they have on the instrument:
 - **Setting commands** cause instrument settings such as a reset of the instrument or setting the frequency.
 - **Queries** cause data to be provided for remote control, e.g. for identification of the instrument or polling a parameter value. Queries are formed by directly appending a question mark to the command header.

- According to their definition in standards:
 - **Common commands:** their function and syntax are precisely defined in standard IEEE 488.2. They are employed identically on all instruments (if implemented). They refer to functions such as management of the standardized status registers, reset and self-test.
 - **Instrument control commands** refer to functions depending on the features of the instrument such as frequency settings. Many of these commands have also been standardized by the SCPI committee. These commands are marked as "SCPI confirmed" in the command reference chapters. Commands without this SCPI label are device-specific; however, their syntax follows SCPI rules as permitted by the standard.

Instrument responses

Instrument responses (response messages and service requests) are messages the instrument sends to the controller after a query. They can contain measurement results, instrument settings and information on the instrument status.

7.4.1.5 SCPI Command Structure

SCPI commands consist of a header and, in most cases, one or more parameters. The header and the parameters are separated by a "white space" (ASCII code 0 to 9, 11 to 32 decimal, e.g. blank). The headers may consist of several mnemonics (keywords). Queries are formed by appending a question mark directly to the header.

The commands can be either device-specific or device-independent (common commands). Common and device-specific commands differ in their syntax.

Syntax for Common Commands

Common (= device-independent) commands consist of a header preceded by an asterisk (*), and possibly one or more parameters.

Table 7-4: Examples of common commands

*RST	RESET	Resets the instrument.
*ESE	EVENT STATUS ENABLE	Sets the bits of the event status enable registers.
*ESR?	EVENT STATUS QUERY	Queries the contents of the event status register.
*IDN?	IDENTIFICATION QUERY	Queries the instrument identification string.

Syntax for Device-Specific Commands



Not all commands used in the following examples are necessarily implemented in the instrument. For demonstration purposes only, assume the existence of the following commands for this section:

- DISPLAY[:WINDow<1...4>]:MAXimize <Boolean>
- FORMat:READings:DATA <type>[,<length>]
- HCOpy:DEvIce:COLor <Boolean>
- HCOpy:DEvIce:CMAP:COLor:RGB <red>,<green>,<blue>
- HCOpy[:IMMediate]
- HCOpy:ITEM:ALL
- HCOpy:ITEM:LABel <string>
- HCOpy:PAGE:DIMensions:QUADrant[<N>]
- HCOpy:PAGE:ORientation LANDscape | PORTrait
- HCOpy:PAGE:SCALE <numeric value>
- MMEMory:COpy <file_source>,<file_destination>
- SENSE:BANDwidth|BWIDth[:RESolution] <numeric_value>
- SENSE:FREQuency:STOP <numeric value>
- SENSE:LIST:FREQuency <numeric_value>{,<numeric_value>}

- [Long and short form](#)..... 178
- [Numeric Suffixes](#)..... 178
- [Optional Mnemonics](#)..... 179

Long and short form

The mnemonics feature a long form and a short form. The short form is marked by upper case letters, the long form corresponds to the complete word. Either the short form or the long form can be entered; other abbreviations are not permitted.

Example:

HCOpy:DEvIce:COLor ON is equivalent to HCOP:DEV:COL ON.



Case-insensitivity

Upper case and lower case notation only serves to distinguish the two forms in the manual, the instrument itself is case-insensitive.

Numeric Suffixes

If a command can be applied to multiple instances of an object, e.g. specific channels or sources, the required instances can be specified by a suffix added to the command. Numeric suffixes are indicated by angular brackets (<1...4>, <n>, <i>) and are replaced by a single value in the command. Entries without a suffix are interpreted as having the suffix 1.

Example:

Definition: `HCOPY:PAGE:DIMensions:QUADrant [<N>]`

Command: `HCOP:PAGE:DIM:QUAD2`

This command refers to the quadrant 2.

**Different numbering in remote control**

For remote control, the suffix may differ from the number of the corresponding selection used in manual operation. SCPI prescribes that suffix counting starts with 1. Suffix 1 is the default state and used when no specific suffix is specified.

Some standards define a fixed numbering, starting with 0. If the numbering differs in manual operation and remote control, it is indicated for the corresponding command.

Optional Mnemonics

Some command systems permit certain mnemonics to be inserted into the header or omitted. These mnemonics are marked by square brackets in the description. The instrument must recognize the long command to comply with the SCPI standard. Some commands are considerably shortened by these optional mnemonics.

Example:

Definition: `HCOPY[:IMMEDIATE]`

Command: `HCOP:IMM` is equivalent to `HCOP`

**Optional mnemonics with numeric suffixes**

Do not omit an optional mnemonic if it includes a numeric suffix that is relevant for the effect of the command.

Example:

Definition: `DISPlay[:WINDow<1...4>]:MAXimize <Boolean>`

Command: `DISP:MAX ON` refers to window 1.

In order to refer to a window other than 1, you must include the optional `WINDow` parameter with the suffix for the required window.

`DISP:WIND2:MAX ON` refers to window 2.

SCPI Parameters

Many commands are supplemented by a parameter or a list of parameters. The parameters must be separated from the header by a "white space" (ASCII code 0 to 9, 11 to 32 decimal, e.g. blank).

The parameters required for each command and the allowed range of values are specified in the command description.

Allowed parameters are:

- [Numeric Values](#)..... 180
- [Special Numeric Values](#)..... 180
- [Boolean Parameters](#)..... 181

• Text Parameters	181
• Character Strings	181
• Block Data	182

Numeric Values

Numeric values can be entered in any form, i.e. with sign, decimal point and exponent. Values exceeding the resolution of the instrument are rounded up or down. The mantissa may comprise up to 255 characters, the exponent must lie inside the value range -32000 to 32000. The exponent is introduced by an "E" or "e". Entry of the exponent alone is not allowed.

Example:

```
SENS:FREQ:STOP 1500000 = SENS:FREQ:STOP 1.5E6
```

Units

For physical quantities, the unit can be entered. If the unit is missing, the basic unit is used. Allowed unit prefixes are:

- G (giga)
- MA (mega), MOHM, MHZ
- K (kilo)
- M (milli)
- U (micro)
- N (nano)

Example:

```
SENSe:FREQ:STOP 1.5GHz = SENSe:FREQ:STOP 1.5E9
```

Some settings allow relative values to be stated in percent. According to SCPI, this unit is represented by the `PCT` string.

Example:

```
HCOP:PAGE:SCAL 90PCT
```

Special Numeric Values

The following mnemonics are special numeric values. In the response to a query, the numeric value is provided.

- **MIN and MAX:** denote the minimum and maximum value.
- **DEF:** denotes a preset value which has been stored in the EPROM. This value conforms to the default setting, as it is called by the `*RST` command.
- **UP and DOWN:** increases or reduces the numeric value by one step. The step width can be specified via an allocated step command for each parameter which can be set via UP and DOWN.
- **INF and NINF:** INFINITY and negative INFINITY (NINF) represent the numeric values 9.9E37 or -9.9E37, respectively. INF and NINF are only sent as instrument responses.

- **NAN:** Not A Number (NAN) represents the value 9.91E37. NAN is only sent as a instrument response. This value is not defined. Possible causes are the division of zero by zero, the subtraction of infinite from infinite and the representation of missing values.

Example:

Setting command: `SENSe:LIST:FREQ MAXimum`

Query: `SENS:LIST:FREQ?`

Response: `3.5E9`

**Queries for special numeric values**

The numeric values associated to `MAXimum`/`MINimum`/`DEFault` can be queried by adding the corresponding mnemonic after the quotation mark.

Example: `SENSe:LIST:FREQ? MAXimum`

Returns the maximum numeric value as a result.

Boolean Parameters

Boolean parameters represent two states. The "ON" state (logically true) is represented by "ON" or a numeric value 1. The "OFF" state (logically untrue) is represented by "OFF" or the numeric value 0. The numeric values are provided as the response for a query.

Example:

Setting command: `HCOPY:DEV:COL ON`

Query: `HCOPY:DEV:COL?`

Response: `1`

Text Parameters

Text parameters observe the syntactic rules for mnemonics, i.e. they can be entered using a short or long form. Like any parameter, they have to be separated from the header by a white space. In the response to a query, the short form of the text is provided.

Example:

Setting command: `HCOPY:PAGE:ORIENTATION LANDscape`

Query: `HCOP:PAGE:ORI?`

Response: `LAND`

Character Strings

Strings must always be entered in quotation marks (' or ").

Example:

```
HCOP:ITEM:LABel "Test1"
```

```
HCOP:ITEM:LABel 'Test1'
```

Block Data

Block data is a format which is suitable for the transmission of large amounts of data. For example, a command using a block data parameter has the following structure:

```
FORMat:READings:DATA #45168xxxxxxxx
```

The ASCII character # introduces the data block. The next number indicates how many of the following digits describe the length of the data block. In the example the 4 following digits indicate the length to be 5168 bytes. The data bytes follow. During the transmission of these data bytes all end or other control signs are ignored until all bytes are transmitted.

#0 specifies a data block of indefinite length. The use of the indefinite format requires a NL^END message to terminate the data block. This format is useful when the length of the transmission is not known or if speed or other considerations prevent segmentation of the data into blocks of definite length.

Overview of Syntax Elements

The following tables provide an overview of the syntax elements and special characters.

Table 7-5: Syntax elements

:	The colon separates the mnemonics of a command.
;	The semicolon separates two commands of a command line. It does not alter the path.
,	The comma separates several parameters of a command.
?	The question mark forms a query.
*	The asterisk marks a common command.
' '	Quotation marks introduce a string and terminate it (both single and double quotation marks are possible).
#	The hash symbol introduces binary, octal, hexadecimal and block data. <ul style="list-style-type: none"> • Binary: #B10110 • Octal: #O7612 • Hexa: #HF3A7 • Block: #21312
	A "white space" (ASCII-Code 0 to 9, 11 to 32 decimal, e.g. blank) separates the header from the parameters.

Table 7-6: Special characters

 	<p>Parameters</p> <p>A vertical stroke in parameter definitions indicates alternative possibilities in the sense of "or". The effect of the command differs, depending on which parameter is used.</p> <p>Example:</p> <p>Definition: <code>HCOPY:PAGE:ORIENTATION LANDscape PORTRait</code></p> <p>Command <code>HCOPY:PAGE:ORI LAND</code> specifies landscape orientation</p> <p>Command <code>HCOPY:PAGE:ORI PORT</code> specifies portrait orientation</p> <p>Mnemonics</p> <p>A selection of mnemonics with an identical effect exists for several commands. These mnemonics are indicated in the same line; they are separated by a vertical stroke. Only one of these mnemonics needs to be included in the header of the command. The effect of the command is independent of which of the mnemonics is used.</p> <p>Example:</p> <p>Definition: <code>SENSE:BANDwidth BWIDTH[:RESolution] <numeric_value></code></p> <p>The two following commands with identical meaning can be created:</p> <p><code>SENS:BAND:RES 1</code></p> <p><code>SENS:BWID:RES 1</code></p>
[]	<p>Mnemonics in square brackets are optional and may be inserted into the header or omitted.</p> <p>Example: <code>HCOPY[:IMMEDIATE]</code></p> <p><code>HCOPY:IMM</code> is equivalent to <code>HCOPY</code></p>
{}	<p>Parameters in curly brackets are optional and can be inserted once or several times, or omitted.</p> <p>Example: <code>SENSE:LIST:FREQUENCY <numeric_value>{,<numeric_value>}</code></p> <p>The following are valid commands:</p> <p><code>SENS:LIST:FREQ 10</code></p> <p><code>SENS:LIST:FREQ 10,20</code></p> <p><code>SENS:LIST:FREQ 10,20,30,40</code></p>

Structure of a Command Line

A command line may consist of one or several commands. It is terminated by one of the following:

- <New Line>
- <New Line> with EOI
- EOI together with the last data byte

Several commands in a command line must be separated by a semicolon ";".

Example:

```
MMEM:COPY "Test1", "MeasurementXY";:HCOP:ITEM ALL
```

This command line contains two commands. The first command belongs to the MMEM system, the second command belongs to the HCOP system. If the next command belongs to a different command system, the semicolon is followed by a colon.

Example:

```
HCOP:ITEM ALL;:HCOP:IMM
```

This command line contains two commands. Both commands are part of the HCOP command system, i.e. they have one level in common.

If the successive commands belong to the same system, having one or several levels in common, the command line can be abbreviated. When abbreviating the command line, the second command begins with the level below HCOP. The colon after the semi-colon is omitted. The abbreviated form of the command line reads as follows:

```
HCOP:ITEM ALL;IMM
```

Example:

```
HCOP:ITEM ALL
```

```
HCOP:IMM
```

A new command line always begins with the complete path.

Responses to Queries

A query is defined for each setting command unless explicitly specified otherwise. It is formed by adding a question mark to the associated setting command. According to SCPI, the responses to queries are partly subject to stricter rules than in standard IEEE 488.2.

- The requested parameter is transmitted without a header.
Example: HCOP:PAGE:ORI?, Response: LAND
- Maximum values, minimum values and all other quantities that are requested via a special text parameter are returned as numeric values.
Example: SENSE:FREQUENCY:STOP? MAX, Response: 3.5E9
- Numeric values are output without a unit. Physical quantities are referred to the basic units or to the units set using the Unit command. The response 3.5E9 in the previous example stands for 3.5 GHz.
- Truth values (Boolean values) are returned as 0 (for OFF) and 1 (for ON).
Example:
Setting command: HCOpy:DEV:COL ON
Query: HCOpy:DEV:COL?
Response: 1
- Text (character data) is returned in a short form.
Example:
Setting command: HCOpy:PAGE:ORIENTATION LANDscape
Query: HCOP:PAGE:ORI?
Response: LAND
- Invalid numerical results
In some cases, particularly when a result consists of multiple numeric values, invalid values are returned as 9.91E37 (not a number).

7.4.1.6 Command Sequence and Synchronization

IEEE 488.2 defines a distinction between overlapped and sequential commands:

- A sequential command is one which finishes executing before the next command starts executing. Commands that are processed quickly are usually implemented as sequential commands.
- An overlapping command is one which does not automatically finish executing before the next command starts executing. Usually, overlapping commands take longer to process and allow the program to do other tasks while being executed. If overlapping commands do have to be executed in a defined order, e.g. in order to avoid wrong measurement results, they must be serviced sequentially. This is called synchronization between the controller and the instrument.

Setting commands within one command line, even though they may be implemented as sequential commands, are not necessarily serviced in the order in which they have been received. In order to make sure that commands are actually carried out in a certain order, each command must be sent in a separate command line.

Example: Commands and queries in one message

The response to a query combined in a program message with commands that affect the queried value is not predictable.

The following commands always return the specified result:

```
:FREQ:STAR 1GHZ;SPAN 100;:FREQ:STAR?
```

Result:

```
1000000000 (1 GHz)
```

Whereas the result for the following commands is not specified by SCPI:

```
:FREQ:STAR 1GHz;STAR?;SPAN 1000000
```

The result could be the value of `STARt` before the command was sent since the instrument might defer executing the individual commands until a program message terminator is received. The result could also be 1 GHz if the instrument executes commands as they are received.



As a general rule, send commands and queries in different program messages.

Example: Overlapping command with *OPC

The instrument implements `INITiate[:IMMEDIATE]` as an overlapped command. Assuming that `INITiate[:IMMEDIATE]` takes longer to execute than `*OPC`, sending the following command sequence results in initiating a sweep and, after some time, setting the `OPC` bit in the `ESR`:

```
INIT; *OPC.
```

Sending the following commands still initiates a sweep:

```
INIT; *OPC; *CLS
```

However, since the operation is still pending when the instrument executes `*CLS`, forcing it into the "Operation Complete Command Idle" State (OCIS), `*OPC` is effectively skipped. The `OPC` bit is not set until the instrument executes another `*OPC` command.

Preventing Overlapping Execution

To prevent an overlapping execution of commands, one of the commands `*OPC`, `*OPC?` or `*WAI` can be used. All three commands cause a certain action only to be carried out after the hardware has been set. The controller can be forced to wait for the corresponding action to occur.

Table 7-7: Synchronization using *OPC, *OPC? and *WAI

Command	Action	Programming the controller
*OPC	Sets the Operation Complete bit in the ESR after all previous commands have been executed.	<ul style="list-style-type: none"> Setting bit 0 in the ESE Setting bit 5 in the SRE Waiting for service request (SRQ)
*OPC?	Stops command processing until 1 is returned. This occurs when all pending operations are completed.	Send *OPC? directly after the command whose processing must be terminated before other commands can be executed.
*WAI	Stops further command processing until all commands sent before *WAI have been executed.	Send *WAI directly after the command whose processing must be terminated before other commands are executed.

Command synchronization using `*WAI` or `*OPC?` is a good choice if the overlapped command takes only little time to process. The two synchronization commands simply block overlapped execution of the command. Append the synchronization command to the overlapping command, for example:

```
SINGLE; *OPC?
```

For time consuming overlapped commands, you can allow the controller or the instrument to do other useful work while waiting for command execution. Use one of the following methods:

***OPC with a service request**

1. Set the OPC mask bit (bit no. 0) in the ESE: `*ESE 1`
2. Set bit no. 5 in the SRE: `*SRE 32` to enable ESB service request.
3. Send the overlapped command with `*OPC` .

4. Wait for a service request.

The service request indicates that the overlapped command has finished.

***OPC? with a service request**

1. Set bit no. 4 in the SRE: `*SRE 16` to enable MAV service request.
2. Send the overlapped command with `*OPC?`.
3. Wait for a service request.

The service request indicates that the overlapped command has finished.

Event status register (ESE)

1. Set the OPC mask bit (bit no. 0) in the ESE: `*ESE 1`
2. Send the overlapped command without `*OPC`, `*OPC?` or `*WAI`.
3. Poll the operation complete state periodically (with a timer) using the sequence:
`*OPC; *ESR?`

A return value (LSB) of 1 indicates that the overlapped command has finished.

7.4.1.7 Status Reporting System

The status reporting system stores all information on the current operating state of the instrument, and on errors which have occurred. This information is stored in the status registers and in the error queue. Both can be queried via GPIB bus or LAN interface (`STATus...` commands).

(See [Chapter 9.12, "Using the Status Register"](#), on page 947).

- [Hierarchy of Status Registers](#)..... 187
- [Structure of a SCPI Status Register](#)..... 189
- [Contents of the Status Registers](#)..... 190
- [Application of the Status Reporting System](#)..... 200
- [Reset Values of the Status Reporting System](#)..... 203

Hierarchy of Status Registers

As shown in the following figure, the status information is of hierarchical structure.

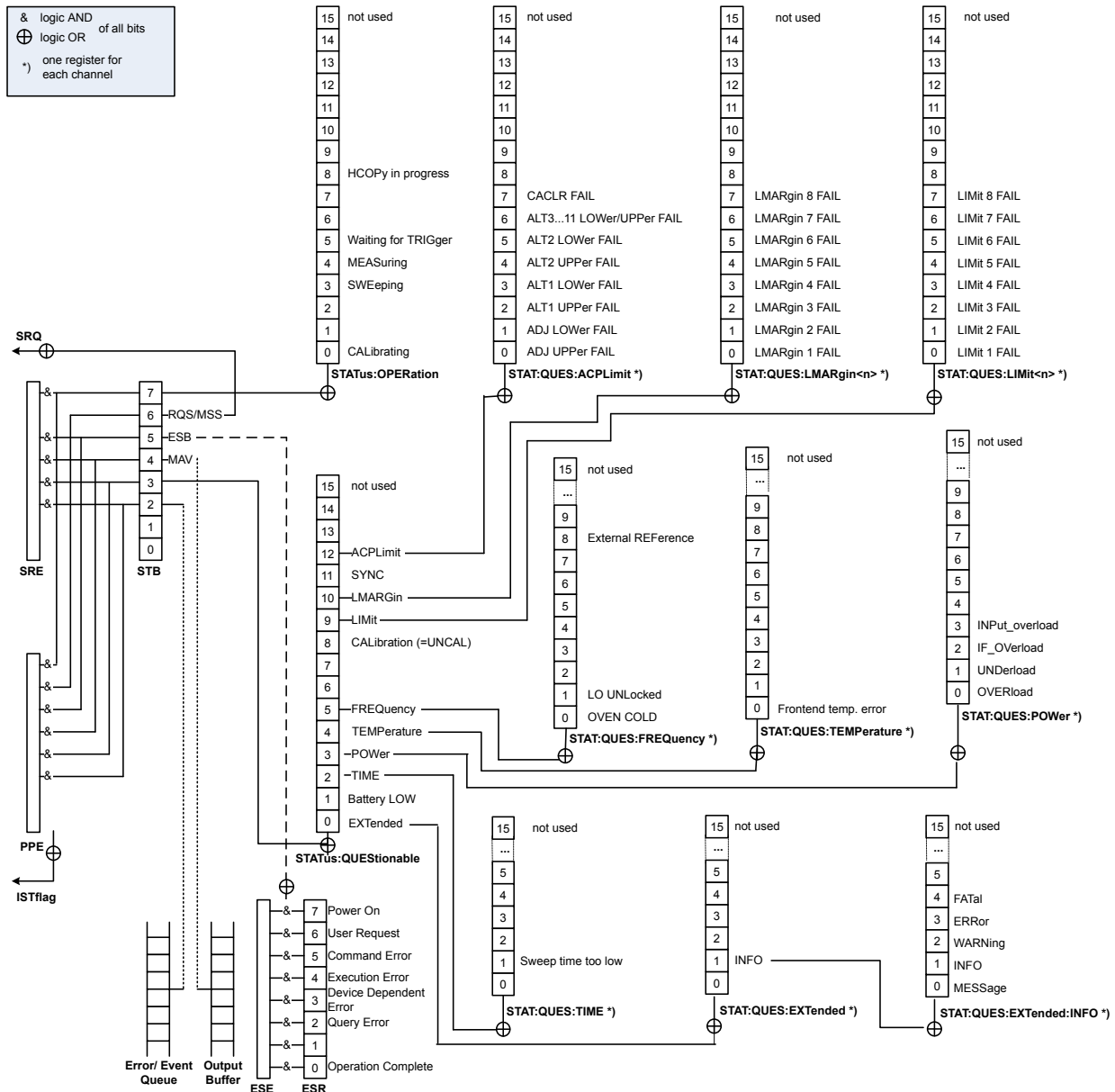

Figure 7-2: Graphical overview of the R&S FPL1000 status registers hierarchy

- **STB, SRE**
The STatus Byte (STB) register and its associated mask register Service Request Enable (SRE) form the highest level of the status reporting system. The STB provides a rough overview of the instrument status, collecting the information of the lower-level registers.
- **ESR, SCPI registers**
The STB receives its information from the following registers:
 - The Event Status Register (ESR) with the associated mask register standard Event Status Enable (ESE).
 - The STATus:OPERation and STATus:QUESTIONable registers which are defined by SCPI and contain detailed information on the instrument.

- **IST, PPE**

The **IST** flag ("Individual Status"), like the **SRQ**, combines the entire instrument status in a single bit. The **PPE** fulfills the same function for the **IST** flag as the **SRE** for the service request.

- **Output buffer**

The output buffer contains the messages the instrument returns to the controller. It is not part of the status reporting system but determines the value of the **MAV** bit in the **STB** and thus is represented in the overview.

All status registers have the same internal structure.



SRE, ESE

The service request enable register **SRE** can be used as **ENABLE** part of the **STB** if the **STB** is structured according to **SCPI**. By analogy, the **ESE** can be used as the **ENABLE** part of the **ESR**.

Structure of a SCPI Status Register

Each standard **SCPI** register consists of 5 parts. Each part has a width of 16 bits and has different functions. The individual bits are independent of each other, i.e. each hardware status is assigned a bit number which is valid for all five parts. Bit 15 (the most significant bit) is set to zero for all parts. Thus the contents of the register parts can be processed by the controller as positive integers.

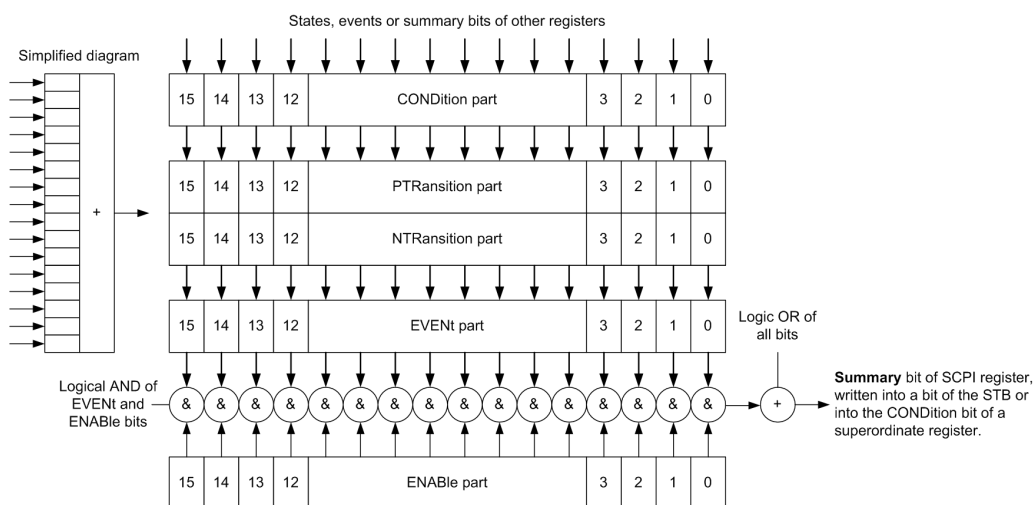

Figure 7-3: The status-register model

Description of the five status register parts

The five parts of a **SCPI** register have different properties and functions:

- **CONDition**

The **CONDition** part is written into directly by the hardware or the sum bit of the next lower register. Its contents reflect the current instrument status. This register part can only be read, but not written into or cleared. Its contents are not affected by reading.

- **PTRansition / NTRansition**

The two transition register parts define which state transition of the `CONDition` part (none, 0 to 1, 1 to 0 or both) is stored in the `EVENT` part.

The **Positive-TRansition** part acts as a transition filter. When a bit of the `CONDition` part is changed from 0 to 1, the associated `PTR` bit decides whether the `EVENT` bit is set to 1.

- `PTR` bit =1: the `EVENT` bit is set.
- `PTR` bit =0: the `EVENT` bit is not set.

This part can be written into and read as required. Its contents are not affected by reading.

The **Negative-TRansition** part also acts as a transition filter. When a bit of the `CONDition` part is changed from 1 to 0, the associated `NTR` bit decides whether the `EVENT` bit is set to 1.

- `NTR` bit =1: the `EVENT` bit is set.
- `NTR` bit =0: the `EVENT` bit is not set.

This part can be written into and read as required. Its contents are not affected by reading.

- **EVENT**

The `EVENT` part indicates whether an event has occurred since the last reading, it is the "memory" of the condition part. It only indicates events passed on by the transition filters. It is permanently updated by the instrument. This part can only be read by the user. Reading the register clears it. This part is often equated with the entire register.

- **ENABLE**

The `ENABLE` part determines whether the associated `EVENT` bit contributes to the sum bit (see below). Each bit of the `EVENT` part is "ANDed" with the associated `ENABLE` bit (symbol '&'). The results of all logical operations of this part are passed on to the sum bit via an "OR" function (symbol '+').

`ENABLE` bit = 0: the associated `EVENT` bit does not contribute to the sum bit

`ENABLE` bit = 1: if the associated `EVENT` bit is "1", the sum bit is set to "1" as well.

This part can be written into and read by the user as required. Its contents are not affected by reading.

Sum bit

The sum bit is obtained from the `EVENT` and `ENABLE` part for each register. The result is then entered into a bit of the `CONDition` part of the higher-order register.

The instrument automatically generates the sum bit for each register. Thus an event can lead to a service request throughout all levels of the hierarchy.

Contents of the Status Registers

In the following sections, the contents of the status registers are described in more detail.



STATUS:QUESTIONABLE:SYNC register

The STATUS:QUESTIONABLE:SYNC register is used by the R&S FPL1000 applications and is described in the individual sections (manuals) for each application.

- Status Byte (STB) and Service Request Enable Register (SRE)..... 191
- IST Flag and Parallel Poll Enable Register (PPE)..... 192
- Event Status Register (ESR) and Event Status Enable Register (ESE)..... 192
- STATUS:OPERation Register..... 193
- STATUS:QUESTIONable Register..... 194
- STATUS:QUESTIONable:ACPLimit Register..... 195
- STATUS:QUESTIONable:EXTended Register..... 196
- STATUS:QUESTIONable:EXTended:INFO Register..... 196
- STATUS:QUESTIONable:FREQuency Register..... 197
- STATUS:QUESTIONable:LIMit Register..... 197
- STATUS:QUESTIONable:LMARgin Register..... 198
- STATUS:QUESTIONable:POWer Register..... 199
- STATUS:QUESTIONable:TEMPerature Register..... 199
- STATUS:QUESTIONable:TIME Register..... 200

Status Byte (STB) and Service Request Enable Register (SRE)

The STATUS Byte (STB) is already defined in IEEE 488.2. It provides a rough overview of the instrument status by collecting the pieces of information of the lower registers. A special feature is that bit 6 acts as the sum bit of the remaining bits of the status byte.

The STB can thus be compared with the CONDITION part of an SCPI register and assumes the highest level within the SCPI hierarchy.

The STB is read using the command `*STB?` or a serial poll.

The STATUS Byte (STB) is linked to the Service Request Enable (SRE) register. Each bit of the STB is assigned a bit in the SRE. Bit 6 of the SRE is ignored. If a bit is set in the SRE and the associated bit in the STB changes from 0 to 1, a service request (SRQ) is generated. The SRE can be set using the command `*SRE` and read using the command `*SRE?`.

Table 7-8: Meaning of the bits used in the status byte

Bit No.	Meaning
0...1	Not used
2	Error Queue not empty The bit is set when an entry is made in the error queue. If this bit is enabled by the SRE, each entry of the error queue generates a service request. Thus an error can be recognized and specified in greater detail by polling the error queue. The poll provides an informative error message. This procedure is to be recommended since it considerably reduces the problems involved with remote control.
3	QUESTIONable status register summary bit The bit is set if an EVENT bit is set in the QUESTIONable status register and the associated ENABLE bit is set to 1. A set bit indicates a questionable instrument status, which can be specified in greater detail by querying the STATUS:QUESTIONable status register.

Bit No.	Meaning
4	MAV bit (message available) The bit is set if a message is available in the output queue which can be read. This bit can be used to enable data to be automatically read from the instrument to the controller.
5	ESB bit Sum bit of the event status register. It is set if one of the bits in the event status register is set and enabled in the event status enable register. Setting of this bit indicates a serious error which can be specified in greater detail by polling the event status register.
6	MSS bit (master status summary bit) The bit is set if the instrument triggers a service request. This is the case if one of the other bits of this registers is set together with its mask bit in the service request enable register SRE.
7	STaTus:OPERation status register summary bit The bit is set if an EVENt bit is set in the OPErAtion status register and the associated ENABle bit is set to 1. A set bit indicates that the instrument is just performing an action. The type of action can be determined by querying the STaTus:OPERation status register.

IST Flag and Parallel Poll Enable Register (PPE)

As with the SRQ, the IST flag combines the entire status information in a single bit. It can be read by means of a parallel poll (see "Parallel Poll" on page 201) or using the command `*IST?`.

The parallel poll enable register (PPE) determines which bits of the STB contribute to the IST flag. The bits of the STB are "ANDed" with the corresponding bits of the PPE, with bit 6 being used as well in contrast to the SRE. The IST flag results from the "ORing" of all results. The PPE can be set using commands `*PRE` and read using command `*PRE?`.

Event Status Register (ESR) and Event Status Enable Register (ESE)

The ESR is defined in IEEE 488.2. It can be compared with the EVENt part of a SCPI register. The event status register can be read out using command `*ESR?`.

The ESE corresponds to the ENABle part of a SCPI register. If a bit is set in the ESE and the associated bit in the ESR changes from 0 to 1, the ESB bit in the STB is set. The ESE register can be set using the command `*ESE` and read using the command `*ESE?`.

Table 7-9: Meaning of the bits used in the event status register

Bit No.	Meaning
0	Operation Complete This bit is set on receipt of the command <code>*OPC</code> exactly when all previous commands have been executed.
1	Not used
2	Query Error This bit is set if either the controller wants to read data from the instrument without having sent a query, or if it does not fetch requested data and sends new instructions to the instrument instead. The cause is often a query which is faulty and hence cannot be executed.

Bit No.	Meaning
3	Device-dependent Error This bit is set if a device-dependent error occurs. An error message with a number between -300 and -399 or a positive error number, which denotes the error in greater detail, is entered into the error queue.
4	Execution Error This bit is set if a received command is syntactically correct but cannot be performed for other reasons. An error message with a number between -200 and -300, which denotes the error in greater detail, is entered into the error queue.
5	Command Error This bit is set if a command is received, which is undefined or syntactically incorrect. An error message with a number between -100 and -200, which denotes the error in greater detail, is entered into the error queue.
6	User Request This bit is set when the instrument is switched over to manual control.
7	Power On (supply voltage on) This bit is set on switching on the instrument.

STATus:OPERation Register

The `STATus:OPERation` register contains information on current activities of the R&S FPL1000. It also contains information on activities that have been executed since the last read out.

You can read out the register with `STATus:OPERation:CONDition?` or `STATus:OPERation[:EVENT]?`.

Table 7-10: Meaning of the bits used in the STATus:OPERation register

Bit No.	Meaning
0	CALibrating This bit is set as long as the instrument is performing a self-alignment.
1-2	Not used
3	SWEEping Sweep is being performed in base unit (applications are not considered); identical to bit 4 In applications, this bit is not used.
4	MEASuring Measurement is being performed in base unit (applications are not considered); identical to bit 3 In applications, this bit is not used.
5	Waiting for TRigger Instrument is ready to trigger and waiting for trigger signal.
6-7	Not used
8	HardCOpy in progress This bit is set while the instrument is printing a hardcopy.
9	not used

Bit No.	Meaning
10-14	Not used
15	This bit is always 0.

STATus:QUEStionable Register

The STATus:QUEStionable register contains information on instrument states that do not meet the specifications.



The STAT:QUES:SYNC register is used by the applications and is thus described in the individual applications' User Manuals.

You can read out the register with STAT:QUES:COND or STAT:QUES:EVEN.



The STATus:QUEStionable register "sums up" the information from all subregisters (e.g. bit 2 sums up the information for all STATus:QUEStionable:TIME registers). For some subregisters, there may be separate registers for each active channel. Thus, if a status bit in the STATus:QUEStionable register indicates an error, the error may have occurred in any of the channel-specific subregisters. In this case, you must check the subregister of each channel to determine which channel caused the error. By default, querying the status of a subregister always returns the result for the currently selected channel.

Table 7-11: Meaning of the bits used in the STATus:QUEStionable register

Bit No.	Meaning
0	Unused
1	"Battery LOW" This bit is set if the battery needs to be charged or a fixed power supply must be connected to the R&S FPL1000 to continue operation.
2	"TIME" This bit is set if a time error occurs in any of the active channels. The STATus:QUEStionable:TIME Register provides more information on the error type.
3	"POWer" This bit is set if the measured power level in any of the active channels is questionable. The STATus:QUEStionable:POWer Register provides more information on the error type.
4	"TEMPerature" This bit is set if the temperature is questionable.
5	"FREQuency" This bit is set if there is anything wrong with the frequency of the local oscillator or the reference frequency in any of the active channels. The STATus:QUEStionable:FREQuency Register provides more information on the error type.
6 - 7	Unused

Bit No.	Meaning
8	"CALibration" This bit is set if the R&S FPL1000 is unaligned ("UNCAL" display)
9	"LIMit" (device-specific) This bit is set if a limit value is violated in any of the active channels in any window. The STATus:QUEStionable:LIMit Register provides more information on the error type.
10	"LMARgin" (device-specific) This bit is set if a margin is violated in any of the active channels in any window. The STATus:QUEStionable:LMARgin Register provides more information on the error type.
11	"SYNC" (device-specific) This bit is set if the R&S FPL1000 is not synchronized to the signal that is applied. The R&S FPL1000 is not synchronized if: <ul style="list-style-type: none"> • it cannot synchronize to midamble during a measurement or premeasurement • it cannot find a burst during a measurement or premeasurement • the results deviate too much from the expected value during premeasurements
12	"ACPLimit" (device-specific) This bit is set if a limit during ACLR measurements is violated in any of the active channels. The STATus:QUEStionable:ACPLimit Register provides more information on the error type.
13-14	Unused
15	This bit is always 0.

STATus:QUEStionable:ACPLimit Register

Available for the Spectrum application.

The STATus:QUEStionable:ACPLimit register contains information about the results of a limit check during ACLR measurements. A separate ACPLimit register exists for each active channel.

You can read out the register with [STATus:QUEStionable:ACPLimit:CONDition?](#) or [STATus:QUEStionable:ACPLimit\[:EVENT\]?](#)

Table 7-12: Meaning of the bits used in the STATus:QUEStionable:ACPLimit register

Bit No.	Meaning
0	ADJ UPPer FAIL This bit is set if the limit is exceeded in the upper adjacent channel
1	ADJ LOWer FAIL This bit is set if the limit is exceeded in the lower adjacent channel.
2	ALT1 UPPer FAIL This bit is set if the limit is exceeded in the upper 1st alternate channel.
3	ALT1 LOWer FAIL This bit is set if the limit is exceeded in the lower 1st alternate channel.
4	ALT2 UPPer FAIL This bit is set if the limit is exceeded in the upper 2nd alternate channel.

Bit No.	Meaning
5	ALT2 LOWER FAIL This bit is set if the limit is exceeded in the lower 2nd alternate channel.
6	ALT3 ... 11 LOWER/UPPER FAIL This bit is set if the limit is exceeded in one of the lower or upper alternate channels 3 ... 11.
7	CACLR FAIL This bit is set if the CACLR limit is exceeded in one of the gap channels.
8-14	Unused
15	This bit is always 0.

STATUS:QUESTIONABLE:EXTENDED Register

The `STATUS:QUESTIONABLE:EXTENDED` register contains further status information not covered by the other status registers of the R&S FPL1000. A separate `EXTENDED` register exists for each active channel.

You can read out the register with `STATUS:QUESTIONABLE:EXTENDED:CONDITION?` or `STATUS:QUESTIONABLE:EXTENDED[:EVENT]?`

Table 7-13: Meaning of the bits used in the STATUS:QUESTIONABLE:EXTENDED register

Bit No.	Meaning
0	not used
1	INFO This bit is set if a status message is available for the application. Which type of message occurred is indicated in the <code>STATUS:QUESTIONABLE:EXTENDED:INFO Register</code> .
2 to 14	Unused
15	This bit is always 0.

STATUS:QUESTIONABLE:EXTENDED:INFO Register

The `STATUS:QUESTIONABLE:EXTENDED:INFO` register contains information on the type of messages that occur during operation of the R&S FPL1000. A separate `INFO` register exists for each active channel.

You can read out the register with `STATUS:QUESTIONABLE:EXTENDED:INFO:CONDITION?` or `STATUS:QUESTIONABLE:EXTENDED:INFO[:EVENT]?`. You can query all messages that occur for a specific channel using the command `SYSTEM:ERROR:EXTENDED?` on page 910.

Table 7-14: Meaning of the bits used in the STATUS:QUESTIONABLE:EXTENDED:INFO register

Bit No.	Meaning
0	MESSAge This bit is set if event or state has occurred that may lead to an error during further operation.
1	INFO This bit is set if an informational status message is available for the application.

Bit No.	Meaning
2	WARNing This bit is set if an irregular situation occurs during measurement, e.g. the settings no longer match the displayed results, or the connection to an external device was interrupted temporarily.
3	ERRor This bit is set if an error occurs during a measurement, e.g. due to missing data or wrong settings, so that the measurement cannot be completed correctly.
4	FATal This bit is set if a serious error occurs in the application and regular operation is no longer possible.
5 to 14	Unused
15	This bit is always 0.

STATus:QUEStionable:FREQuency Register

The STATus:QUEStionable:FREQuency register contains information about the condition of the local oscillator and the reference frequency. A separate frequency register exists for each active channel.

You can read out the register with `STATus:QUEStionable:FREQuency:CONDition?` or `STATus:QUEStionable:FREQuency[:EVENT]?`.

Table 7-15: Meaning of the bits used in the STATus:QUEStionable:FREQuency register

Bit No.	Meaning
0	OVEN COLD This bit is set if the reference oscillator has not yet attained its operating temperature. "OCXO" is displayed.
1	LO UNLocked This bit is set if the local oscillator no longer locks. "LOUNL" is displayed.
2 to 7	Not used
8	EXTernalREFerence This bit is set if you have selected an external reference oscillator but did not connect a useable external reference source. In that case the synthesizer can not lock. The frequency in all probability is not accurate.
9 to 14	Not used
15	This bit is always 0.

STATus:QUEStionable:LIMit Register

The STATus:QUEStionable:LIMit register contains information about the results of a limit check when you are working with limit lines.

A separate LIMit register exists for each active channel and for each window.

You can read out the register with `STATus:QUEStionable:LIMit<n>:CONDition?` or `STATus:QUEStionable:LIMit<n>[:EVENT]?`.

Table 7-16: Meaning of the bits used in the STATUS:QUESTIONable:LIMit register

Bit No.	Meaning
0	LIMit 1 FAIL This bit is set if limit line 1 is violated.
1	LIMit 2 FAIL This bit is set if limit line 2 is violated.
2	LIMit 3 FAIL This bit is set if limit line 3 is violated.
3	LIMit 4 FAIL This bit is set if limit line 4 is violated.
4	LIMit 5 FAIL This bit is set if limit line 5 is violated.
5	LIMit 6 FAIL This bit is set if limit line 6 is violated.
6	LIMit 7 FAIL This bit is set if limit line 7 is violated.
7	LIMit 8 FAIL This bit is set if limit line 8 is violated.
8 to 14	Unused
15	This bit is always 0.

STATUS:QUESTIONable:LMARgin Register

This register contains information about the observance of limit margins.

A separate LMARgin register exists for each active channel and for each window.

It can be read using the commands

STATUS:QUESTIONable:LMARgin:CONDition? and
STATUS:QUESTIONable:LMARgin[:EVENT]?

Table 7-17: Meaning of the bits used in the STATUS:QUESTIONable:LMARgin register

Bit No.	Meaning
0	LMARgin 1 FAIL This bit is set if limit margin 1 is violated.
1	LMARgin 2 FAIL This bit is set if limit margin 2 is violated.
2	LMARgin 3 FAIL This bit is set if limit margin 3 is violated.
3	LMARgin 4 FAIL This bit is set if limit margin 4 is violated.
4	LMARgin 5 FAIL This bit is set if limit margin 5 is violated.

Bit No.	Meaning
5	LMARgin 6 FAIL This bit is set if limit margin 6 is violated.
6	LMARgin 7 FAIL This bit is set if limit margin 7 is violated.
7	LMARgin 8 FAIL This bit is set if limit margin 8 is violated.
8 to 14	Not used
15	This bit is always 0.

STATus:QUEStionable:POWer Register

The `STATus:QUEStionable:POWer` register contains information about possible overload situations that may occur during operation of the R&S FPL1000. A separate power register exists for each active channel.

You can read out the register with `STATus:QUEStionable:POWer:CONDition?` or `STATus:QUEStionable:POWer[:EVENT]?`

Table 7-18: Meaning of the bits used in the `STATus:QUEStionable:POWer` register

Bit No.	Meaning
0	OVERload This bit is set if an overload occurs at the RF input, causing signal distortion but not yet causing damage to the device. The R&S FPL1000 displays the keyword "RF OVLD".
1	Unused
2	IF_Overload This bit is set if an overload occurs in the IF path. The R&S FPL1000 displays the keyword "IF OVLD".
3	Input Overload This bit is set if the signal level at the RF input connector exceeds the maximum. The RF input is disconnected from the input mixer to protect the device. In order to re-enable measurement, decrease the level at the RF input connector and reconnect the RF input to the mixer input. For details on the protection mechanism see " RF Input Protection " on page 410 or <code>INPut<ip>:ATTenuation:PROtection:RESet</code> on page 742. The R&S FPL1000 displays the keyword "INPUT OVLD".
4 to 14	Unused
15	This bit is always 0.

STATus:QUEStionable:TEMPerature Register

The `STATus:QUEStionable:TEMPerature` register contains information about possible temperature deviations that may occur during operation of the R&S FPL1000. A separate temperature register exists for each active channel.

You can read out the register with `STATUS:QUESTIONABLE:TEMPERATURE:CONDITION?` or `STATUS:QUESTIONABLE:TEMPERATURE[:EVENT]?`

Table 7-19: Meaning of the bits used in the STATUS:QUESTIONABLE:TEMPERATURE register

Bit No.	Meaning
0	This bit is set if the frontend temperature sensor deviates by a certain degree from the self-alignment temperature. During warmup, this bit is always 0. For details see "Temperature check" on page 163.
1 to 14	Unused
15	This bit is always 0.

STATUS:QUESTIONABLE:TIME Register

The `STATUS:QUESTIONABLE:TIME` register contains information about possible time errors that may occur during operation of the R&S FPL1000. A separate time register exists for each active channel.

You can read out the register with `STATUS:QUESTIONABLE:TIME:CONDITION?` or `STATUS:QUESTIONABLE:TIME[:EVENT]?`

Table 7-20: Meaning of the bits used in the STATUS:QUESTIONABLE:TIME register

Bit No.	Meaning
0	not used
1	Sweep time too low This bit is set if the sweep time is too low.
2 to 14	Unused
15	This bit is always 0.

Application of the Status Reporting System

The purpose of the status reporting system is to monitor the status of one or several devices in a measuring system. To do this and react appropriately, the controller must receive and evaluate the information of all devices. The following standard methods are used:

- **Service request** (SRQ) initiated by the instrument
- **Serial poll** of all devices in the bus system, initiated by the controller in order to find out who sent a SRQ and why
- **Parallel poll** of all devices
- Query of a **specific instrument status** by means of commands
- Query of the **error queue**

Service Request

Under certain circumstances, the instrument can send a service request (SRQ) to the controller. A service request is a request from an instrument for information, advice or treatment by the controller. Usually this service request initiates an interrupt at the con-

troller, to which the control program can react appropriately. As evident from [Figure 7-2](#), an SRQ is always initiated if one or several of bits 2, 3, 4, 5 or 7 of the status byte are set and enabled in the SRE. Each of these bits combines the information of a further register, the error queue or the output buffer. The `ENABLE` parts of the status registers can be set such that arbitrary bits in an arbitrary status register initiate an SRQ. In order to make use of the possibilities of the service request effectively, all bits should be set to "1" in enable registers SRE and ESE.

The service request is the only possibility for the instrument to become active on its own. Each controller program should cause the instrument to initiate a service request if errors occur. The program should react appropriately to the service request.

Use of the command `*OPC` to generate an SRQ at the end of a sweep

1. `CALL InstrWrite(analyzer, "*ESE 1")` 'Set bit 0 in the ESE (Operation Complete)
2. `CALL InstrWrite(analyzer, "*SRE 32")` 'Set bit 5 in the SRE (ESB)
3. `CALL InstrWrite(analyzer, "**INIT;*OPC")` 'Generate an SRQ after operation complete

After its settings have been completed, the instrument generates an SRQ.

A detailed example for a service request routine is provided in [Chapter 9.12.7, "Service Request"](#), on page 951.

Serial Poll

In a serial poll, just as with command `*STB`, the status byte of an instrument is queried. However, the query is realized via interface messages and is thus clearly faster.

The serial poll method is defined in IEEE 488.1 and used to be the only standard possibility for different instruments to poll the status byte. The method also works for instruments which do not adhere to SCPI or IEEE 488.2.

The serial poll is mainly used to obtain a fast overview of the state of several instruments connected to the controller.

Parallel Poll

In a parallel poll, up to eight instruments are simultaneously requested by the controller using a single command to transmit 1 bit of information each on the data lines, i.e., to set the data line allocated to each instrument to a logical "0" or "1".

In addition to the SRE register, which determines the conditions under which an SRQ is generated, there is a Parallel Poll Enable register (PPE) which is ANDed with the STB bit by bit, considering bit 6 as well. This register is ANDed with the STB bit by bit, considering bit 6 as well. The results are ORed, the result is possibly inverted and then sent as a response to the parallel poll of the controller. The result can also be queried without parallel poll using the command `*IST?`.

The instrument first has to be set for the parallel poll using the command `PPC`. This command allocates a data line to the instrument and determines whether the response is to be inverted. The parallel poll itself is executed using `PPE`.

The parallel poll method is mainly used to find out quickly which one of the instruments connected to the controller has sent a service request. To this effect, SRE and PPE must be set to the same value.

Query of an instrument status

Each part of any status register can be read using queries. There are two types of commands:

- The common commands `*ESR?`, `*IDN?`, `*IST?`, `*STB?` query the higher-level registers.
- The commands of the `STATUS` system query the SCPI registers (`STATUS:QUESTIONABLE...`)

The returned value is always a decimal number that represents the bit pattern of the queried register. This number is evaluated by the controller program.

Queries are usually used after an SRQ in order to obtain more detailed information on the cause of the SRQ.

Decimal representation of a bit pattern

The STB and ESR registers contain 8 bits, the SCPI registers 16 bits. The contents of a status register are specified and transferred as a single decimal number. To make this possible, each bit is assigned a weighted value. The decimal number is calculated as the sum of the weighted values of all bits in the register that are set to 1.

Bits	0	1	2	3	4	5	6	7	...
Weight	1	2	4	8	16	32	64	128	...

Example:

The decimal value $40 = 32 + 8$ indicates that bits no. 3 and 5 in the status register (e.g. the `QUESTIONABLE` status summary bit and the `ESB` bit in the `STATUS Byte`) are set.

Error Queue

Each error state in the instrument leads to an entry in the error queue. The entries of the error queue are detailed plain text error messages that can be looked up in the Error Log or queried via remote control using `SYSTEM:ERROR[:NEXT]?`. Each call of `SYSTEM:ERROR[:NEXT]?` provides one entry from the error queue. If no error messages are stored there any more, the instrument responds with 0, "No error".

The error queue should be queried after every SRQ in the controller program as the entries describe the cause of an error more precisely than the status registers. Especially in the test phase of a controller program the error queue should be queried regularly since faulty commands from the controller to the instrument are recorded there as well.

Reset Values of the Status Reporting System

The following table contains the different commands and events causing the status reporting system to be reset. None of the commands, except *RST and SYSTem:PRESet, influence the functional instrument settings. In particular, DCL does not change the instrument settings.

Table 7-21: Resetting the status reporting system

Event	Switching on supply voltage Power-On-Status-Clear		DCL, SDC (Device Clear, Selected Device Clear)	*RST or SYS- Tem:PRE Set	STA- Tus:PRE- Set	*CLS
	0	1				
Clear STB, ESR	-	yes	-	-	-	yes
Clear SRE, ESE	-	yes	-	-	-	-
Clear PPE	-	yes	-	-	-	-
Clear EVENT parts of the registers	-	yes	-	-	-	yes
Clear ENABLE parts of all OPERation and QUEStionable registers; Fill ENABLE parts of all other registers with "1".	-	yes	-	-	yes	-
Fill PTRansition parts with "1"; Clear NTRansition parts	-	yes	-	-	yes	-
Clear error queue	yes	yes	-	-	-	yes
Clear output buffer	yes	yes	yes	1)	1)	1)
Clear command processing and input buffer	yes	yes	yes	-	-	-
1) The first command in a command line that immediately follows a <PROGRAM MESSAGE TERMINATOR> clears the output buffer.						

7.4.1.8 General Programming Recommendations

Initial instrument status before changing settings

Manual operation is designed for maximum possible operating convenience. In contrast, the priority of remote control is the "predictability" of the instrument status. Thus, when a command attempts to define incompatible settings, the command is ignored and the instrument status remains unchanged, i.e. other settings are not automatically adapted. Therefore, control programs should always define an initial instrument status (e.g. using the *RST command) and then implement the required settings.

Command sequence

As a general rule, send commands and queries in different program messages. Otherwise, the result of the query may vary depending on which operation is performed first (see also "[Preventing Overlapping Execution](#)" on page 186).

Reacting to malfunctions

The service request is the only possibility for the instrument to become active on its own. Each controller program should instruct the instrument to initiate a service request in case of malfunction. The program should react appropriately to the service request.

Error queues

The error queue should be queried after every service request in the controller program as the entries describe the cause of an error more precisely than the status registers. Especially in the test phase of a controller program the error queue should be queried regularly since faulty commands from the controller to the instrument are recorded there as well.

7.4.2 GPIB Languages

The R&S FPL1000 analyzer family supports a subset of the GPIB commands used by other devices. Thus it can emulate other devices in order to use existing remote control programs.

Supported languages

Language	Comment
SCPI	
71100C	Compatible to 8566A/B
71200C	Compatible to 8566A/B
71209A	Compatible to 8566A/B
8560E	
8561E	
8562E	
8563E	
8564E	
8565E	
8566A	Command sets A and B are available. Command sets A and B differ in the rules regarding the command structure.
8566B	

Language	Comment
8568A	Command sets A and B are available. Command sets A and B differ in the rules regarding the command structure.
8568A_DC	Uses DC input coupling by default if supported by the instrument
8568B	Command sets A and B are available. Command sets A and B differ in the rules regarding the command structure.
8568B_DC	Uses DC input coupling by default if supported by the instrument
8591E	Compatible to 8594E
8594E	Command sets A and B are available. Command sets A and B differ in the rules regarding the command structure.
CXA/EXA	
R&S FSV	
R&S FSL	

Notes:

- If you select a language other than "SCPI", the GPIB address is set to 18 if it was 20 before.
- The Start/stop frequency, reference level and number of sweep points are adapted to the selected instrument model.
- When you switch between remote control languages, the following settings or changes are made:
SCPI:
The instrument performs a PRESET.
8566A/B, 8568A/B, 8594E; FSEA, FSEB, FSEM; FSEK:
 - The instrument performs a PRESET.
 - The following instrument settings are changed:

Table 7-22: Instrument settings for emulation of 8566A/B, 8568A/B, 8594E; FSEA, FSEB, FSEM; FSEK instruments

Model	# of Trace Points	Start Freq.	Stop Freq.	Ref Level	Input Coupling
8566A/B	1001	2 GHz	22 GHz	0 dBm	AC
8568A/B	1001	0 Hz	1.5 GHz	0 dBm	AC
8560E	601	0 Hz	2.9 GHz	0 dBm	AC
8561E	601	0 Hz	6.5 GHz	0 dBm	AC
8562E	601	0 Hz	13.2 GHz	0 dBm	AC
8563E	601	0 Hz	26.5 GHz	0 dBm	AC
8564E	601	0 Hz	40 GHz	0 dBm	AC
8565E	601	0 Hz	50 GHz	0 dBm	AC
8594E	401	0 Hz	3 GHz	0 dBm	AC

Note: The stop frequency indicated in the table may be limited to the corresponding frequency of the R&S FPL1000, if required.

7.4.3 Network and Remote Control Settings

Access: [SETUP] > "Network + Remote"

The remote commands required to define these settings are described in [Chapter 9.10.6, "Configuring the Network and Remote Control"](#), on page 904.

Step-by-step instructions are provided in [Chapter 7.4.4, "How to Set Up a Network and Remote Control"](#), on page 218.

- [General Network Settings](#).....206
- [Remote Settings](#).....208
- [Compatibility Settings](#).....211
- [LXI Settings](#).....213
- [Remote Errors](#).....215
- [Returning to Manual Mode \("Local"\)](#).....217

7.4.3.1 General Network Settings

Access: [SETUP] > "Network + Remote" > "Network" tab

The R&S FPL1000 can be operated in a local area network (LAN), for example to control the instrument from a remote PC or use a network printer.

NOTICE

Risk of network problems

All parameters can be edited here; however, beware that changing the computer name has major effects in a network.

For details, see [Chapter 7.4.4, "How to Set Up a Network and Remote Control"](#), on page 218.

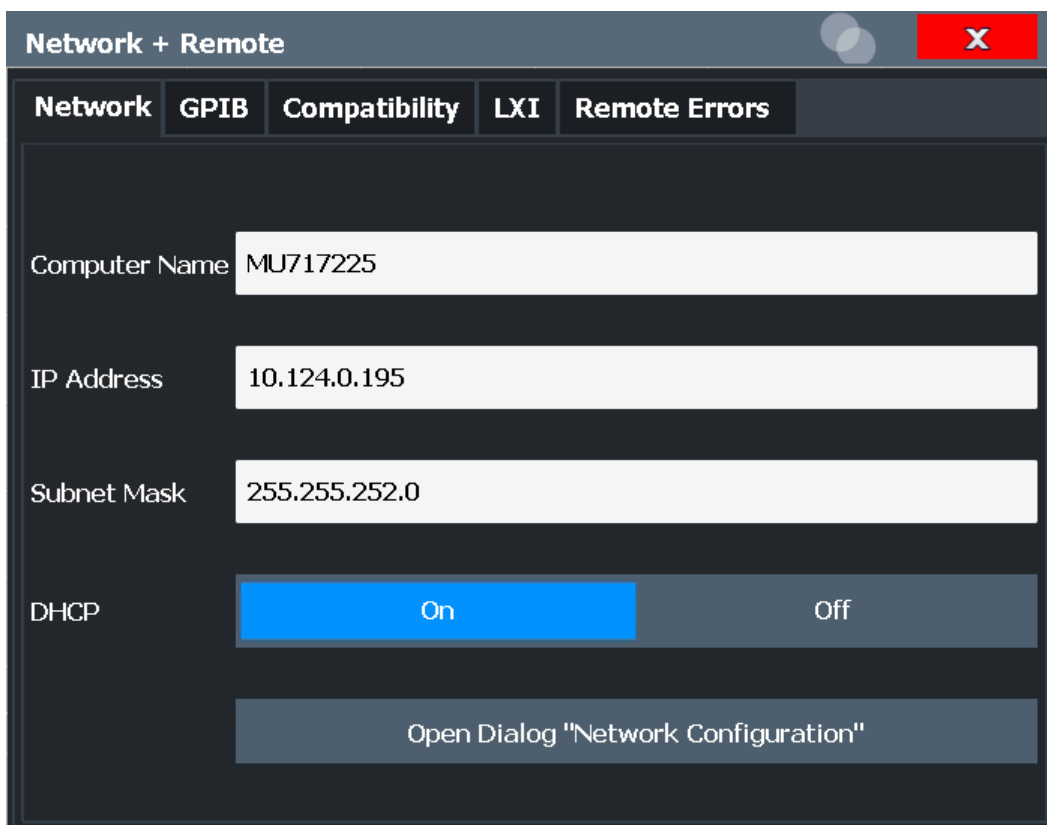

Computer Name.....207
 IP Address.....208
 Subnet Mask.....208
 DHCP.....208
 Network Configuration.....208

Computer Name

Each instrument is delivered with an assigned computer name, but this name can be changed. The naming conventions of Windows apply. If too many characters and/or numbers are entered, an error message is displayed in the status line.

The default instrument name is a non-case-sensitive string with the following syntax:

<Type><variant>-<serial_number>

For example FPL1003-123456

The serial number can be found on the rear panel of the instrument. It is the third part of the device ID printed on the bar code sticker:



IP Address

Defines the IP address. The TCP/IP protocol is preinstalled with the IP address 10.0.0.10. If the DHCP server is available ("DHCP On"), the setting is read-only.

The IP address consists of four number blocks separated by dots. Each block contains 3 numbers in maximum (e.g. 100.100.100.100), but also one or two numbers are allowed in a block (as an example see the preinstalled address).

Subnet Mask

Defines the subnet mask. The TCP/IP protocol is preinstalled with the subnet mask 255.255.255.0. If the DHCP server is available ("DHCP On"), this setting is read-only.

The subnet mask consists of four number blocks separated by dots. Each block contains 3 numbers in maximum (e.g. 100.100.100.100), but also one or two numbers are allowed in a block (as an example see the preinstalled address).

DHCP

Switches between DHCP server available (On) or not available (Off). If a DHCP server is available in the network, the IP address and subnet mask of the instrument are obtained automatically from the DHCP server.

Network Configuration

Opens the standard Windows "Network Configuration" dialog box for further configuration.

7.4.3.2 Remote Settings

Access: [Setup] > "Network + Remote" > "Remote" tab



GPIB-specific settings are only available if option R&S FPL1-B10 is installed on the R&S FPL1000.

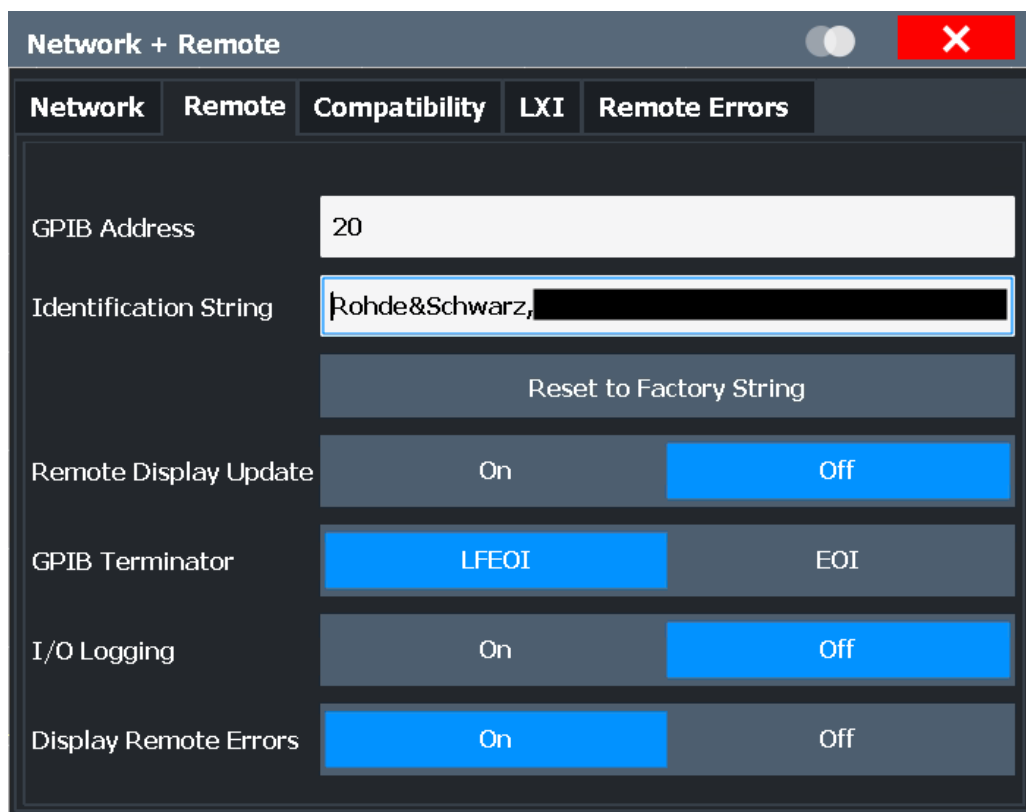

GPIB Address.....	209
Identification String.....	209
Reset to Factory String.....	209
Remote Display Update.....	210
GPIB Terminator.....	210
I/O Logging.....	210
Display Remote Errors.....	210

GPIB Address

Defines the GPIB address. Values from 0 to 30 are allowed. The default address is 20.

Remote command:

[SYSTem:COMMunicate:GPIB\[:SELF\]:ADDRESS](#) on page 904

Identification String

Defines the identification string for the R&S FPL1000 which is provided as a response to the *IDN? query. Maximum 36 characters are allowed.

Remote command:

[SYSTem:IDENTify\[:STRing\]](#) on page 906

Reset to Factory String

Restores the default identification string. Each R&S FPL1000 has a unique ID according to the following syntax:

Rohde&Schwarz,FPL1000,<Unique number>

Remote command:

[SYSTem:IDENtify:FACTory](#) on page 906

Remote Display Update

Defines whether the display of the R&S FPL1000 is updated when changing from manual operation to remote control.

Turning off the display update function improves performance during remote control.

Note: Usually, this function remains available on the display during remote operation. However, it can be disabled remotely. In this case, the display is not updated during remote operation, and cannot be turned on again locally until local operation is resumed.

Remote command:

[SYSTem:DISPlay:UPDate](#) on page 905

GPIO Terminator

Changes the GPIO receive terminator.

"LFEOI" According to the standard, the terminator in ASCII is <LF> and/or <EOI>.

"EOI" For binary data transfers (e.g. trace data) from the control computer to the instrument, the binary code used for <LF> might be included in the binary data block, and therefore should not be interpreted as a terminator in this particular case. This can be avoided by using only the receive terminator EOI.

Remote command:

[SYSTem:COMMunicate:GPIO\[:SELF\]:RTERminator](#) on page 904

I/O Logging

Activates or deactivates the SCPI error log function. All remote control commands received by the R&S FPL1000 are recorded in a log file. The files are named according to the following syntax:

C:

`\Users\Public\Documents\Rohde-Schwarz\Analyzer\ScpiLogging\ScpiLog.<no.>`

where <no.> is a sequential number

A new log file is started each time logging was stopped and is restarted.

Logging the commands may be extremely useful for debug purposes, e.g. in order to find misspelled keywords in control programs.

Remote command:

[SYSTem:CLOGging](#) on page 579

Display Remote Errors

Activates and deactivates the display of errors that occur during remote operation of the R&S FPL1000. If activated, the R&S FPL1000 displays a message box at the bottom of the screen that contains the type of error and the command that caused the error.



The error message remains in place when you switch to "Local" mode. To close the message box, select the  "Close" icon.

Only the most recent error is displayed in remote mode. However, in local mode, all errors that occurred during remote operation are listed in a separate tab of the "Network + Remote" dialog box (see [Chapter 7.4.3.5, "Remote Errors"](#), on page 215).

Remote command:

`SYSTem:ERRor:DISPlay` on page 906

`SYSTem:ERRor:CLEar:REMote` on page 909

7.4.3.3 Compatibility Settings

The R&S FPL1000 can emulate the GPIB interface of other signal and spectrum analyzers, e.g. in order to use existing control applications.



Compatibility with former R&S signal and spectrum analyzers

As a rule, the R&S FPL1000 supports most commands from previous R&S signal and spectrum analyzers such as the FSQ, FSP, FSU, or FSV. However, the default values, in particular the number of sweep points or particular bandwidths, may vary. Therefore, the R&S FPL1000 can emulate these other devices, including their default values, in order to repeat previous measurements or support existing control applications as in legacy systems.

The required settings are configured in the "Compatibility" tab of the "Network + Remote" dialog box.

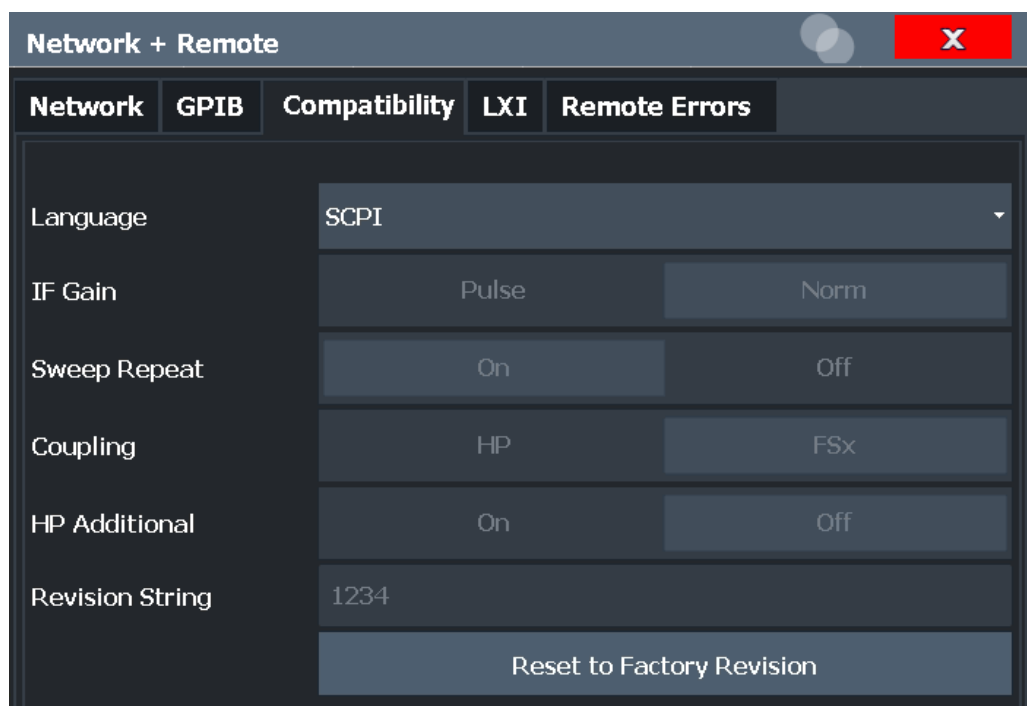

Language.....	212
IF Gain.....	212
Sweep Repeat.....	212
Coupling.....	213
Revision String.....	213
Resetting the Factory Revision.....	213

Language

Defines the system language used to control the instrument.

For details on the available GPIB languages, see [Chapter 9.11.2, "Reference: GPIB Commands of Emulated HP Models"](#), on page 916.

Note: Emulating previous R&S signal and spectrum analyzers. This function is also used to emulate previous R&S signal and spectrum analyzers.

As a rule, the R&S FPL1000 supports most commands from previous R&S signal and spectrum analyzers such as the FSQ, FSP, FSU, or FSV. However, the default values, in particular the number of sweep points or particular bandwidths, may vary. Therefore, the R&S FPL1000 can emulate these other devices, including their default values, in order to repeat previous measurements or support existing control applications as in legacy systems.

Remote command:

[SYSTem:LANGuage](#) on page 915

IF Gain

Configures the internal IF gain settings in HP emulation mode due to the application needs. This setting is only taken into account for resolution bandwidth < 300 kHz.

NORM	Optimized for high dynamic range, overload limit is close to reference level.
PULS	Optimized for pulsed signals, overload limit up to 10 dB above reference level.

This setting is only available if an HP language is selected (see ["Language"](#) on page 212).

Remote command:

[SYSTem:IFGain:MODE](#) on page 915

Sweep Repeat

Controls a repeated sweep of the E1 and MKPK HI HP model commands (for details on the commands refer to [Chapter 9.11.2, "Reference: GPIB Commands of Emulated HP Models"](#), on page 916). If the repeated sweep is OFF, the marker is set without sweeping before.

Note: In single sweep mode, switch off this setting before you set the marker via the E1 and MKPK HI commands in order to avoid sweeping again.

This setting is only available if a HP language is selected (see ["Language"](#) on page 212).

Remote command:

[SYSTem:RSweep](#) on page 916

Coupling

Controls the default coupling ratios in the HP emulation mode for:

- span and resolution bandwidth (Span/RBW)
- resolution bandwidth and video bandwidth (RBW/VBW)

For FSx, the standard parameter coupling of the instrument is used. As a result, in most cases a shorter sweep time is used than in case of HP.

This setting is only available if a HP language is selected (see "[Language](#)" on page 212).

Remote command:

`SYSTem:HPCoupling` on page 914

Revision String

Defines the response to the `REV?` query for the revision number.

(HP emulation only, see "[Language](#)" on page 212).

Max. 36 characters are allowed.

Remote command:

`SYSTem:REVision[:STRing]` on page 916

Resetting the Factory Revision

Resets the response to the `REV?` query for the revision number to the factory default (HP emulation only, see "[Language](#)" on page 212).

Remote command:

`SYSTem:REVision:FACTory` on page 908

7.4.3.4 LXI Settings

Access: [SETUP] > "Network + Remote" > "LXI" tab

On the R&S FPL1000 the LXI Class C functionality is already installed and enabled; thus, the instrument can be accessed via any web browser (e.g. the Microsoft Internet Explorer) to perform the following tasks:

- modifying network configurations
- modifying device configurations
- monitoring connections from the device to other devices

The "LXI" tab of the "Network + Remote" dialog box provides basic LXI functions and information for the R&S FPL1000.

Alternatively, you can change the LAN settings using the LXI Web browser interface.

For details see "[How to Configure the LAN Using the LXI Web Browser Interface](#)" on page 222.

Only user accounts with administrator rights are able to use LXI functionality.

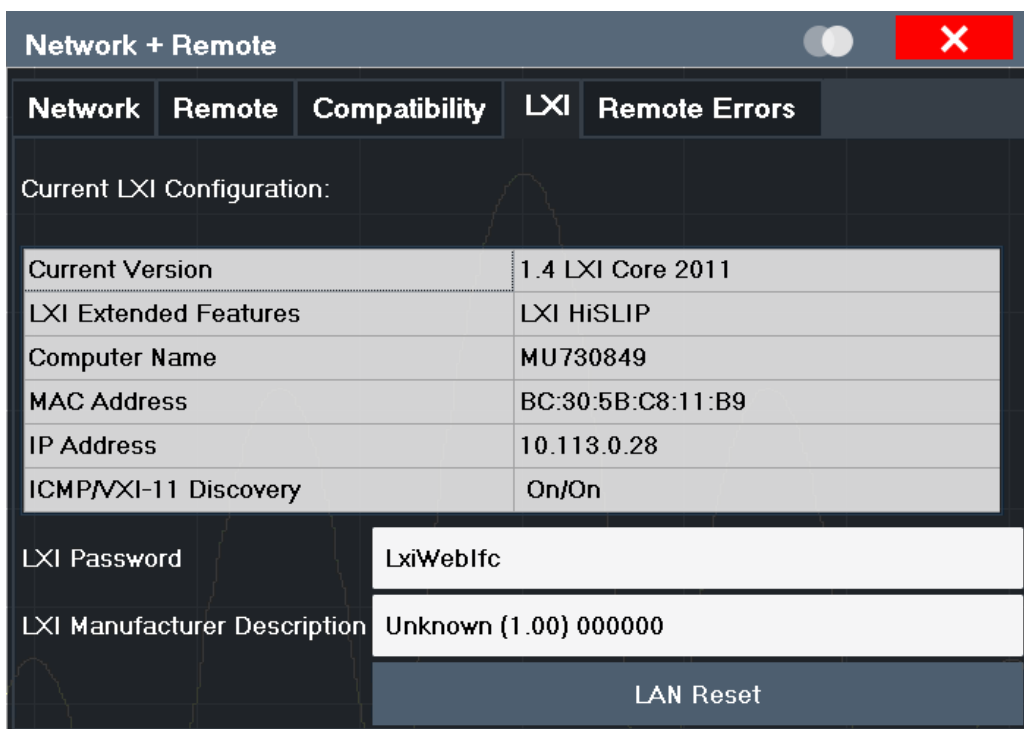

[Current LXI Configuration](#)..... 214
[LXI Password](#)..... 214
[LXI Manufacturer Description](#)..... 215
[LAN Reset](#)..... 215

Current LXI Configuration

Displays the current LXI information from the R&S FPL1000 (read-only).

- "Current ver- sion" Current LXI version
- "LXI Extended Features" Detected LXI features, such as HiSlip (see "[HiSLIP Protocol](#)" on page 170)
- "Computer name" Name of the R&S FPL1000 as defined in the operating system (see also "[Computer Name](#)" on page 207)
- "MAC address" Media Access Control address (MAC address), a unique identifier for the network card in the R&S FPL1000
- "IP address" IP address of the R&S FPL1000 as defined in the operating system (see also "[IP Address](#)" on page 208).
- "ICMP" Indicates whether the ping responder is active or not
- "VXI-11 Discovery" If enabled, connected devices are detected automatically using the VXI-11 protocol (see "[VXI-11 Protocol](#)" on page 170)

Remote command:
[SYSTem:LXI:INFO?](#) on page 907

LXI Password

Password for LAN configuration. The default password is *LxiWebIfc*.

Remote command:

[SYSTem:LXI:PASSword](#) on page 907

LXI Manufacturer Description

Instrument description of the R&S FPL1000

Remote command:

[SYSTem:LXI:MDEScription](#) on page 907

LAN Reset

Resets the LAN configuration to its default settings (LCI function).

According to the LXI standard, an LCI must set the following parameters to a default state.

Parameter	Value
TCP/IP Mode	DHCP + Auto IP Address
Dynamic DNS	Enabled
ICMP Ping	Enabled
Password for LAN configuration	LxiWebIfc

The LAN settings are configured in the "Network" tab of the "Network + Remote" dialog box or using the instrument's LXI Browser interface.

Remote command:

[SYSTem:LXI:LANReset](#) on page 907

7.4.3.5 Remote Errors

Access: [SETUP] > "Network + Remote" > "Remote Errors " tab

The error messages generated by the R&S FPL1000 during remote operation are displayed here.

The messages are displayed in the order of their occurrence; the most recent messages are placed at the top of the list.

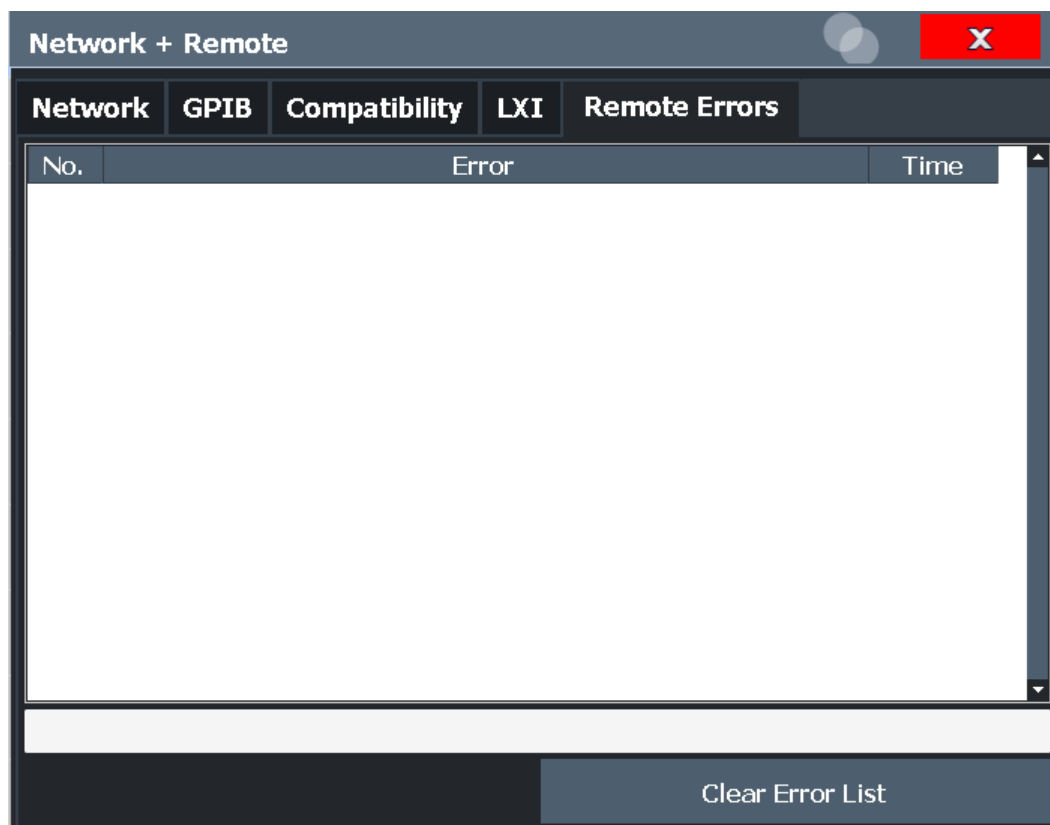

The most recent error message during remote operation can be displayed on the screen, see "[Display Remote Errors](#)" on page 210.

If the number of error messages exceeds the capacity of the error buffer, the oldest error message is removed before the newest one is inserted. To clear the message buffer use the "Clear Error List" button. It is automatically cleared when the R&S FPL1000 is shut down.

The following information is available:

No	Device-specific error code
Error	Brief description of the error
Date/Time	Time the message occurred

Remote command:

`SYSTem:ERRor:LIST?` on page 910

Clear Error List

Deletes the error message buffer for remote operation.

Note: The remote error list is automatically cleared when the R&S FPL1000 is shut down.

Remote command:

[SYSTem:ERRor:CLEar:REMOte](#) on page 909

7.4.3.6 Returning to Manual Mode ("Local")

When switched on, the instrument is always in the manual measurement mode and can be operated via the front panel. As soon as the instrument receives a remote command, it is switched to the remote control mode.

In remote control mode, all keys of the instrument except the [PRESET] key are disabled. The "LOCAL" softkey and the [Remote Display Update](#) softkey are displayed.

Local

The instrument switches from remote to manual operation, but only if the local lockout function has not been activated in the remote control mode (see ["GPIB Interface Messages"](#) on page 173).

Furthermore, when you return to manual operation, the following happens:

- All front panel keys are enabled.
- The main softkey menu of the current mode is displayed.
- The measurement diagrams, traces and display fields are displayed again.
- If, at the time of pressing the "LOCAL" softkey, the synchronization mechanism via *OPC, *OPC? or *WAI is active, the currently running measurement procedure is aborted and synchronization is achieved by setting the corresponding bits in the registers of the status reporting system.
- Bit 6 (User Request) of the Event Status Register is set.
If the status reporting system is configured accordingly, this bit immediately causes the generation of a service request (SRQ) to inform the control software that the user wishes to return to front panel control. For example, this can be used to interrupt the control program and to correct instrument settings manually. This bit is set each time the "LOCAL" softkey is pressed.

Note: Before you switch back to manual operation, all remote command processing must be completed. Otherwise, the instrument will switch back to remote control immediately.

If you select the "Local" softkey while a self-alignment or a self-test is still running (which was started remotely), the instrument only returns to the manual operation state when the alignment or test is completed.

Remote command:

[SYSTem:KLOCK](#) on page 906

7.4.4 How to Set Up a Network and Remote Control

NOTICE

Risk of network failure

Consult your network administrator before performing the following tasks:

- Connecting the instrument to the network
- Configuring the network
- Changing IP addresses
- Exchanging hardware

Errors can affect the entire network.

Remote operation

You can operate the instrument remotely from a connected computer using SCPI commands (see [Chapter 7.4.1.2, "SCPI \(Standard Commands for Programmable Instruments\)"](#), on page 175). Before you send remote commands you must configure the instrument in a LAN network or connect it to a PC via the GPIB interface as described in [Chapter 7.4.4.1, "How to Configure a Network"](#), on page 218.

Remote Desktop

In production test and measurement, a common requirement is central monitoring of the T&M instruments for remote maintenance and remote diagnostics. Equipped with the Remote Desktop software of Windows, the R&S FPL1000 ideally meets requirements for use in production. The computer that is used for remote operation is called "controller" here.

The following tasks can be performed using Remote Desktop:

- Access to the control functions via a virtual front panel (soft front panel)
- Printout of measurement results directly from the controller
- Storage of measured data on the controller's hard disk

This documentation provides basic instructions on setting up the Remote Desktop for the R&S FPL1000. For details refer to the Windows operating system documentation.

7.4.4.1 How to Configure a Network

A precondition for operating or monitoring the instrument remotely is that it is connected to a LAN network or a PC connected to the GPIB interface. This is described here.



Windows Firewall Settings

A firewall protects an instrument by preventing unauthorized users from gaining access to it through a network. Rohde & Schwarz highly recommends the use of the firewall on your instrument. R&S instruments are shipped with the Windows firewall enabled and preconfigured in such a way that all ports and connections for remote control are enabled. For more details on firewall configuration see the Windows help system and the R&S White Paper (available from the Rohde & Schwarz website):

How to Connect the Instrument to the Network

There are two methods to establish a LAN connection to the instrument:

- A non-dedicated network (Ethernet) connection from the instrument to an existing network made with an ordinary RJ-45 network cable. The instrument is assigned an IP address and can coexist with a computer and with other hosts on the same network.
- A dedicated network connection (Point-to-point connection) between the instrument and a single computer made with a (crossover) RJ-45 network cable. The computer must be equipped with a network adapter and is directly connected to the instrument. The use of hubs, switches, or gateways is not required, however, data transfer is still performed using the TCP/IP protocol. An IP address has to be assigned to the instrument and the computer, see "[How to Assign the IP Address](#)" on page 219.

Note: As the R&S FPL1000 uses a 1 GBit LAN, a crossover cable is not necessary (due to Auto-MDI(X) functionality).

- ▶ To establish a non-dedicated network connection, connect a commercial RJ-45 cable to one of the LAN ports.
To establish a dedicated connection, connect a (crossover) RJ-45 cable between the instrument and a single PC.

If the instrument is connected to the LAN, Windows automatically detects the network connection and activates the required drivers.

The network card can be operated with a 1 GBit Ethernet IEEE 802.3u interface.

How to Assign the IP Address

Depending on the network capacities, the TCP/IP address information for the instrument can be obtained in different ways.

- If the network supports dynamic TCP/IP configuration using the Dynamic Host Configuration Protocol (DHCP), all address information can be assigned automatically.
- If the network does not support DHCP, or if the instrument is set to use alternate TCP/IP configuration, the addresses must be set manually.

By default, the instrument is configured to use dynamic TCP/IP configuration and obtain all address information automatically. This means that it is safe to establish a physical connection to the LAN without any previous instrument configuration.



When a DHCP server is used, a new IP address may be assigned each time the PC is restarted. This address must first be determined on the PC itself. Thus, when using a DHCP server, it is recommended that you use the permanent computer name, which determines the address via the DNS server (see ["Using a DNS server to determine the IP address"](#) on page 221).

NOTICE

Risk of network errors

Connection errors can affect the entire network. If your network does not support DHCP, or if you choose to disable dynamic TCP/IP configuration, you must assign valid address information before connecting the instrument to the LAN. Contact your network administrator to obtain a valid IP address.

Assigning the IP address on the instrument

1. Press the [SETUP] key.
2. Press the "Network + Remote" softkey.
3. Select the "Network" tab.
4. In the "Network + Remote" dialog, toggle the "DHCP On/Off" setting to the required mode.

If DHCP is "Off", you must enter the IP address manually, as described in the following steps.

Note: When DHCP is changed from "On" to "Off", the previously set IP address and subnet mask are retrieved.

If DHCP is "On", the IP address of the DHCP server is obtained automatically. The configuration is saved, and you are prompted to restart the instrument. You can skip the remaining steps.

Note: When a DHCP server is used, a new IP address may be assigned each time the instrument is restarted. This address must first be determined on the instrument itself. Thus, when using a DHCP server, it is recommended that you use the permanent computer name, which determines the address via the DNS server (See ["Using a DNS server to determine the IP address"](#) on page 33 and [Chapter 5.1.5.3, "Using Computer Names"](#), on page 34).

5. Enter the "IP Address", for example *192.0.2.0*. The IP address consists of four number blocks separated by dots. Every block contains a maximum of 3 numbers.
6. Enter the "Subnet Mask", for example *255.255.255.0*. The subnet mask consists of four number blocks separated by dots. Every block contains a maximum of 3 numbers.
7. Close the dialog box.

If you have entered an invalid IP address or subnet mask, the message "out of range" is displayed in the status line. If the settings are correct, the configuration is saved, and you are prompted to restart the instrument.

8. Confirm the displayed message ("Yes" button) to restart the instrument.

Using a DNS server to determine the IP address

If a DNS server is configured on the R&S FPL1000, the server can determine the current IP address for the connection using the permanent computer name.

1. Obtain the name of your DNS domain and the IP addresses of the DNS and WINS servers on your network (see ["How to Change the Instrument Name"](#) on page 221).
2. Press the [Setup] key and then the "Network + Remote" softkey.
3. In the "Network" tab, select the "Open Dialog 'Network Connections'" button.
4. Double-tap the "Local Area Network" entry.
5. In the "Local Area Connection Status" dialog box, select the "Properties" button. The items used by the LAN connection are displayed.
6. Tap the entry named "Internet Protocol Version 4 (TCP/IPv4)" to highlight it.

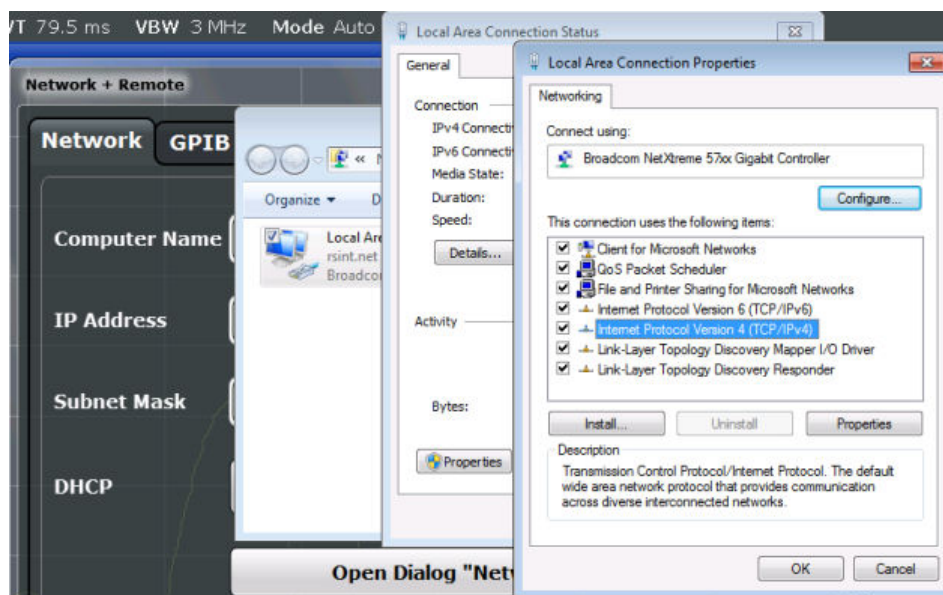

7. Select the "Properties" button.
8. On the "General" tab, select "Use the following DNS server addresses" and enter your own DNS addresses.

For more information refer to the Windows operating system Help.

How to Change the Instrument Name

In a LAN that uses a DNS server (Domain Name System server), each PC or instrument connected in the LAN can be accessed via an unambiguous computer name instead of the IP address. The DNS server translates the host name to the IP address. This is especially useful when a DHCP server is used, as a new IP address may be assigned each time the instrument is restarted.

Each instrument is delivered with an assigned computer name, but this name can be changed.

To change the instrument's computer name

1. Press the [Setup] key and then the "Network + Remote" softkey.
The current "Computer Name" is displayed in the "Network" tab.
2. Enter the new computer name and close the dialog box.
The configuration is saved, and you are prompted to restart the instrument.
3. Confirm the displayed message ("Yes" button) to restart the instrument.

How to Configure the LAN Using the LXI Web Browser Interface

The instrument's LXI browser interface works correctly with all W3C compliant browsers.

- ▶ In the web browser, open the `http://<instrument-hostname>` or `http://<instrument-ip-address>` page, e.g. `http://10.113.10.203`.
The default password to change LAN configurations is *LxiWebIfc*.
The "Instrument Home Page" (welcome page) opens.

The screenshot shows a web browser window with the URL `http://172.23.226.47/web/html/ihp.php`. The page displays the Rohde & Schwarz LXI Instrument Home Page. The main content area is titled "Instrument Properties" and lists the following information:

Instrument Model	R&S FPL1000 Spectrum Analyzer
Manufacturer	Rohde & Schwarz GmbH & Co. KG
Serial Number	[REDACTED]
Description	R&S FPL1000-[REDACTED]
LXI Version	1.4 LXI Core 2011
LXI Extended Features	LXI HiSLIP
DNS Host Name(s)	[REDACTED]
MAC Address	[REDACTED]
IP Address	172.23.226.47
Firmware Revision	1.20
Current Time	Tuesday, 2018/06/12, 06:53:10
Current Time source	Operating System
VISA resource string	TCPIP::172.23.226.47::inst0::INSTR TCPIP::172.23.226.47::hislip0::INSTR
Device Indicator	INACTIVE (press to toggle) ●

The instrument home page displays the device information required by the LXI standard including the VISA resource string in read-only format.

- ▶ Press the "Device Indicator" button on the "Instrument Home Page" to activate or deactivate the LXI status LED to the right of the button. A green LXI status LED indicates that a LAN connection has been established; a red status LED indicates an error, for example, that no LAN cable is connected. When a device is connecting to the instrument, the LXI status LED blinks. The "Device Indicator" setting is not password-protected.

The most important control elements in the navigation pane of the browser interface are the following:

- "LAN Configuration" opens the menu with configuration pages.
- "Status" displays information about the LXI status of the instrument.
- "Help > Glossary" opens a document with a glossary of terms related to the LXI standard.

LAN Configuration

The LAN configuration consists of three parts:

- "IP configuration" provides all mandatory LAN parameters.
- "Advanced LAN Configuration" provides LAN settings that are not declared mandatory by the LXI standard.
- "Ping Client" provides the ping utility to verify the connection between the instrument and other devices.

IP Configuration

The "LAN Configuration > IP configuration" web page displays all mandatory LAN parameters and allows their modification.

The "TCP/IP Mode" configuration field controls how the IP address for the instrument gets assigned (see also "[How to Assign the IP Address](#)" on page 219).

For the manual configuration mode, the static IP address, subnet mask, and default gateway are used to configure the LAN. The automatic configuration mode uses DHCP server or Dynamic Link Local Addressing (Automatic IP) to obtain the instrument IP address.



Changing the LAN configuration is password-protected. The default password is *Lxi-WebIfc* (notice upper and lower case characters).

You can change the LXI password in the "Network + Remote" dialog box, see [Chapter 7.4.3.4, "LXI Settings"](#), on page 213

Advanced LAN Configuration

The "LAN Configuration > Advanced LAN Configuration" parameters are used as follows:

- The "Negotiation" configuration field provides different Ethernet speed and duplex mode settings. In general, the "Auto Detect" mode is sufficient.
- "ICMP Ping" must be enabled to use the ping utility.

- "VXI-11" is the protocol that is used to detect the instrument in the LAN. According to the standard, LXI devices must use VXI-11 to provide a detection mechanism; other additional detection mechanisms are permitted.
- mDNS and DNS-SD are two additional protocols: Multicast DNS and DNS Service Discovery. They are used for device communication in zero configuration networks working without DNS and DHCP

Ping Client

Ping is a utility that verifies the connection between the LXI-compliant instrument and another device. The ping command uses the `ICMP` echo request and echo reply packets to determine whether the LAN connection is functional. Ping is useful for diagnosing IP network or router failures. The ping utility is not password-protected.

To initiate a ping between the LXI-compliant instrument and a second connected device:

1. Enable "ICMP Ping" on the "Advanced LAN Configuration" page (enabled after an LCI).
2. Enter the IP address of the second device **without the ping command and without any further parameters** into the "Destination Address" field (e.g. `10.113.10.203`).
3. Select "Submit".

How to Change the GPIB Instrument Address

In order to operate the instrument via remote control, it must be addressed using the GPIB address. The remote control address is factory-set to 20, but it can be changed if it does not fit in the network environment. For remote control, addresses 0 through 30 are allowed. The GPIB address is maintained after a reset of the instrument settings.

Setting the GPIB address

1. On the R&S FPL1000, press the [SETUP] key.
2. Press the "Network + Remote" softkey.
3. In the "Network + Remote" dialog box, select the "GPIB" tab.
4. In the "GPIB Address" field, enter a value between 0 and 30.

Remote command:

```
SYST:COMM:GPIB:ADDR 18
```

7.4.4.2 How to Operate the Instrument Without a Network

To operate the instrument without a network connection either temporarily or permanently, no special measures are necessary. Windows automatically detects the interruption of the network connection and does not set up the connection when the instrument is switched on.

If you are not prompted to enter the user name and password, proceed as described in ["How to Activate or Deactivate the Automatic Login Mechanism"](#) on page 226.

7.4.4.3 How to Log on to the Network

Windows requires that users identify themselves by entering a user name and password in a login window. You can set up two types of user accounts, either an administrator account with unrestricted access to the computer/domain or a standard user account with limited access. The instrument provides an auto-login function for the administrator account, i.e. login with unrestricted access is carried out automatically in the background. By default, the user name for the administrator account is "Instrument", and the user name for the standard user account is "NormalUser". In both cases the initial password is "894129". You can change the password in Windows for any user at any time. Some administrative tasks require administrator rights (e.g. firmware updates or the configuration of a LAN network).

Refer to [Chapter 7.3, "General Instrument Setup"](#), on page 130 to find out which functions are affected.

At the same time you log on to the operating system, you are automatically logged on to the network. As a prerequisite, the user name and the password must be identical on the instrument and on the network.

How to Create Users

After the software for the network has been installed, the instrument issues an error message the next time it is switched on because there is no user named "instrument" (= default user ID for Windows automatic login) in the network. Thus, a matching user must be created in the R&S FPL1000 and in the network, the password must be adapted to the network password, and the automatic login mechanism must then be deactivated.

The network administrator is responsible for creating new users in the network.

1.



Select the "Windows" icon in the toolbar to access the operating system.

2. Select "Start > Settings > Accounts > Other users".
3. Select "Add someone else to this PC".
4. In the "Microsoft account" dialog box, enter the new user name and password.
5. Select "OK".
6. Select "Finish".
The new user is created.

How to Change the User Password

After the new user has been created on the instrument, the password must be adapted to the network password.

1.



Select the "Windows" icon in the toolbar to access the operating system.

2. Press [Ctrl + Alt + Delete], then select "Change a password".

3. Enter the user account name.

4. Enter the old password.

5. Enter the new password in the upper text line and repeat it in the following line.

6. Press [Enter].

The new password is now active.

How to Activate or Deactivate the Automatic Login Mechanism

Deactivating the automatic login mechanism

When shipped, the instrument is already configured to automatically log on under Windows. To deactivate the automatic login mechanism, perform the following steps:

1. In the "Start" menu, select "Run".

The "Run" dialog box is displayed.

2. Enter the command

```
C:\Users\Public\Documents\Rohde-Schwarz\Analyzer\user\  
NO_AUTOLOGIN.REG.
```

3. Press the [ENTER] key to confirm.

The automatic login mechanism is deactivated. The next time you switch on the instrument, you are prompted to enter your user name and password before the firmware is started.

Reactivating the automatic login mechanism

1. In the "Start" menu, select "Run".

The "Run" dialog box is displayed.

2. Enter the command

```
C:\Users\Public\Documents\Rohde-Schwarz\Analyzer\user\  
AUTOLOGIN.REG.
```

3. Press the [ENTER] key to confirm.

The automatic login mechanism is reactivated. It will be applied the next time the instrument is switched on.

7.4.4.4 How to Share Directories (only with Microsoft Networks)

Sharing directories makes data available for other users. This is only possible in Microsoft networks. Sharing is a property of a file or directory.

1. In the "Start" menu, select "Programs", "Accessories" and then select "Windows Explorer".
2. Select the desired folder with the right mouse button.
3. In the context menu, select "Sharing with > Specific people".
The dialog box for sharing a directory is displayed.
4. Select a user from the list or add a new name and select the "Add" button.
5. Select the "Share" button.
6. Select "Done" to close the dialog box.
The drive is shared and can be accessed by the selected users.

7.4.4.5 How to Control the R&S FPL1000 via the Web Browser Interface

Via the LXI browser interface to the R&S FPL1000 one or more users can control the instrument remotely from another PC without additional installation. Most instrument controls are available via the front panel simulation. File upload and download between the instrument and the remote PC is also available.

To access the R&S FPL1000 via the web browser interface

1. Start a web browser that supports html5 (W3C compliant).
2. Enter the IP address of the R&S FPL1000 in the browser's address bar.
The R&S FPL1000's Welcome page is displayed.
3. In the navigation pane, select "Instrument Control > Web Control".
The instrument's display is shown in a new browser window, with a software front panel displayed beside or below it.
4. Use the mouse cursor to access the functionality in the software front panel or in the display as you would directly on the instrument's front panel.

To exchange files with the R&S FPL1000

You can download files, for example stored measurement data, from the R&S FPL1000 to the remote PC, or upload files, for example limit line definitions, from the PC to the R&S FPL1000.

1. In the web browser, select the Welcome page window.
2. In the navigation pane, select "Instrument Control" > "File Upload" or "File Download".

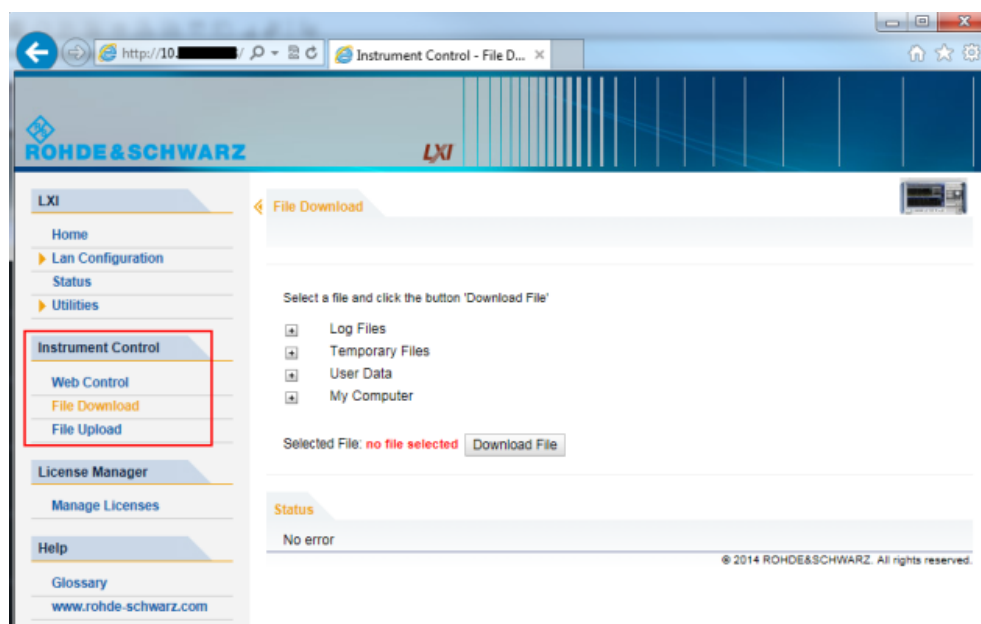

The most commonly used folders on the instrument are displayed, for example those that contain user data, as well as the top-most *My Computer* folder, from which you can access all other folders on the instrument.

3. To download a file from the R&S FPL1000, select the file from the displayed folders and then select "Download File".
4. To upload a file to the R&S FPL1000:
 - a) From the displayed folders in the web browser window, select the folder on the R&S FPL1000 to which you want to copy a file.
 - b) Under "File to Upload", select "Browse" to open a file selection dialog box and select the required file on the PC.
 - c) Select "Upload" to copy the file from the PC to the defined folder on the R&S FPL1000.

7.4.4.6 How to Deactivate the Web Browser Interface

If you want to prevent other users in the LAN from accessing or operating the R&S FPL1000 via its LXI web browser interface, you must deactivate this function. Note that **after a firmware update** the function is **automatically active** again until you deactivate it manually.

To deactivate the LXI web browser interface

1.



Select the "Windows" icon in the toolbar to access the operating system.

2. In the "Start" menu, select "Control Panel".

3. Select "System and Security" > "Administrative Tools".
4. From the list on the right, select "Services".
5. From the list of local services, select "R&S TightVNC Server".

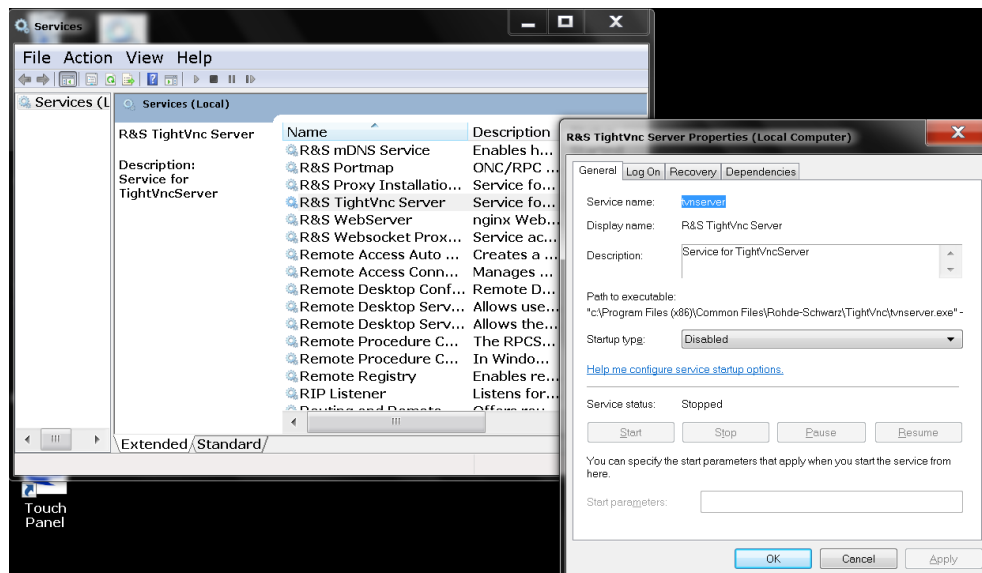

6. Set "Startup type" to "Disabled".
7. Select "Stop".
8. Select "Apply".

The next time a user enters the IP address of the instrument in a web browser, an error message is displayed:

```
Failed to connect to server (code. 1006)
```

7.4.4.7 How to Set Up Remote Desktop

Remote Desktop is a Windows application which can be used to access and control the instrument from a remote computer through a LAN connection. While the instrument is in operation, the instrument screen contents are displayed on the remote computer, and Remote Desktop provides access to all of the applications, files, and network resources of the instrument. Thus, remote operation of the R&S FPL1000 is possible.

With Windows, Remote Desktop Client is part of the operating system. For other versions of Windows, Microsoft offers the Remote Desktop Client as an add-on. For details refer to the Windows operating system documentation.

With the factory settings, the default "instrument" user can connect to the R&S FPL1000 with the Remote Desktop program of the controller immediately. No further configuration is required. However, if the connection fails or other users need to connect, this section provides basic instructions on setting up the Remote Desktop for the R&S FPL1000.

How to Configure the R&S FPL1000 for Remote Operation via Remote Desktop

1. Create a fixed IP address for the TCP/IP protocol as described in ["How to Assign the IP Address"](#) on page 219.

Note: To avoid problems, use a fixed IP address.

When a DHCP server is used, a new IP address is assigned each time the instrument is restarted. This address must first be determined on the instrument itself. Thus, using a DHCP server is not suitable for remote operation of the R&S FPL1000 via Remote Desktop.

- 2.



Select the "Windows" icon in the toolbar to access the operating system.

3. In the Windows "Start" menu, select "Settings > System".
4. Search for "remote access".
5. Select "Allow remote access to your computer".
6. Define which users are to be given access to the R&S FPL1000 via Remote Desktop.

Note: The user account under which configuration is carried out is automatically enabled for Remote Desktop.

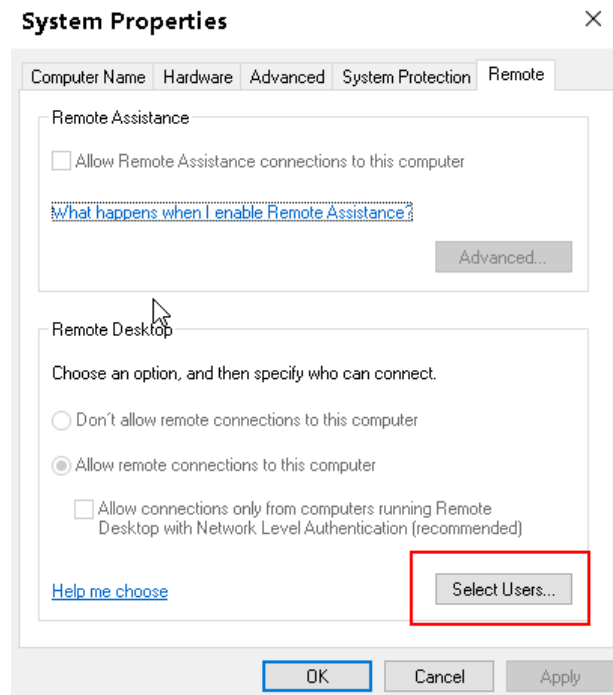

- a) Select the "Select Users" button.
- b) Select the users or create new user accounts as described in ["How to Create Users"](#) on page 225.

- c) Select "OK" to confirm the settings.
7. The R&S FPL1000 is now ready for connection setup with the Remote Desktop program of the controller.

How to Configure the Controller



Remote Desktop Client

With Windows, Remote Desktop Client is part of the operating system and can be accessed via "Start > Programs > Accessories > Remote Desktop Connection".

For other versions of Windows, Microsoft offers the Remote Desktop Client as an add-on.

1.



Select the "Windows" icon in the toolbar to access the operating system.

2. From the "Start" menu, select "All Programs > Accessories > Remote Desktop Connection".

The "Remote Desktop Connection" dialog box is displayed.

3. Select the "Options >>" button.

The dialog box is expanded to display the configuration data.

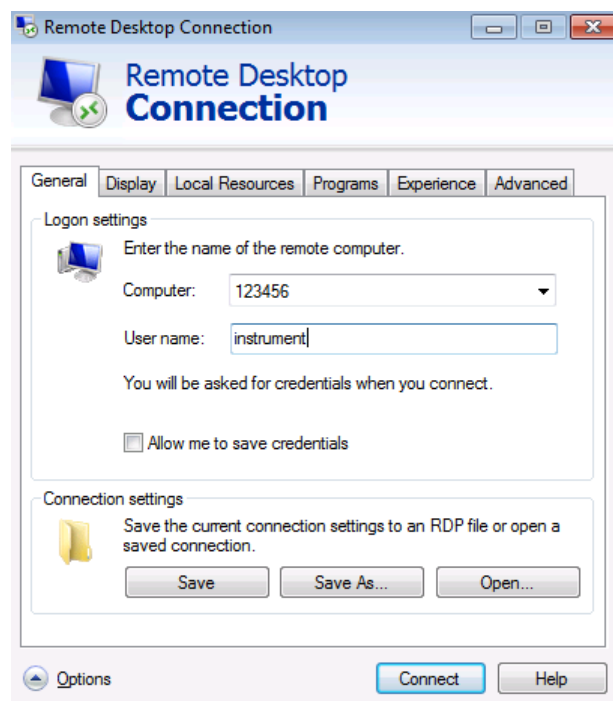

4. Open the "Experience" tab.
The settings on this tab are used to select and optimize the connection speed.

- In the list, select the appropriate connection (for example: LAN (10 Mbps or higher)).
Depending on your selection (and how powerful the connection is), the options are activated or deactivated.
- To improve the performance, you can deactivate the "Desktop background", "Show contents of window while dragging" and "Menu and window animation" options.
- Open the "Local Resources" tab for enabling printers, local drives and serial interfaces.
- If you will need to access drives of the controller from the R&S FPL1000 (e.g. in order to store settings or to copy files from the controller to the R&S FPL1000), select "More", then enable the "Drives" option.

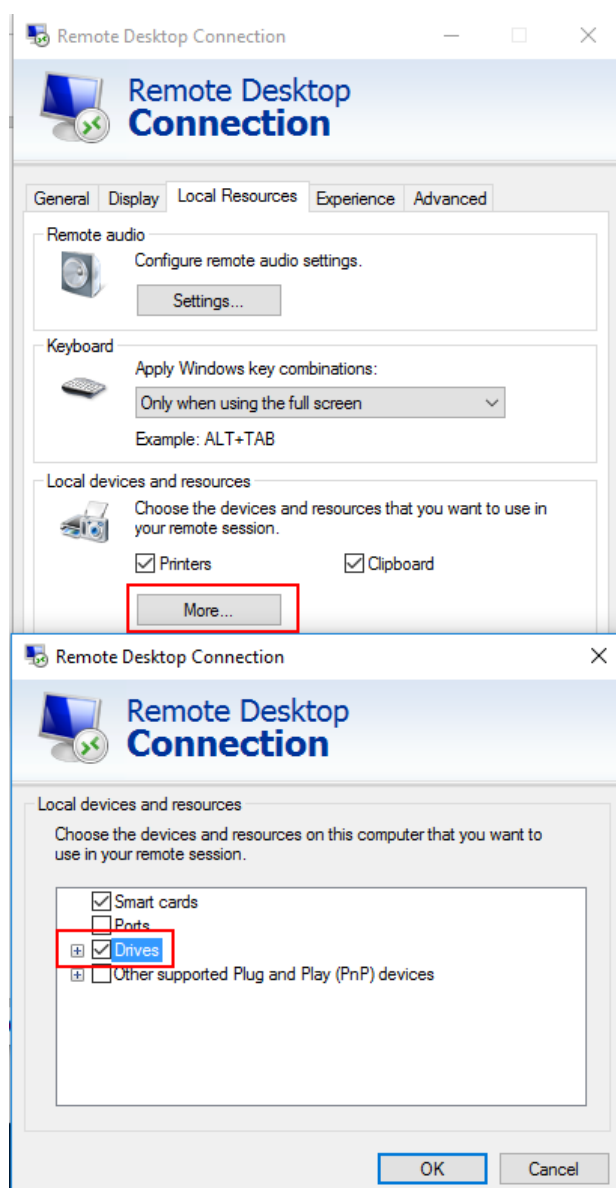

Windows will then map drives of the controller to the corresponding network drives.

9. To use printers connected to the controller while accessing them from the R&S FPL1000, activate the "Printers" option. Do not change the remaining settings.
10. Open the "Display" tab.
The options for configuring the R&S FPL1000 screen display are displayed.
11. Under "Remote desktop size", you can set the size of the R&S FPL1000 window on the desktop of the controller.
12. Under "Colors", do not change the settings.
13. Set the "Display the connection bar when I use the full screen" option:
 - If activated, a bar showing the network address of the R&S FPL1000 will appear at the top edge of the screen. You can use this bar to reduce, minimize or close the window.
 - If deactivated, the only way you can return to the controller desktop from the R&S FPL1000 screen in full screen mode is to select "Disconnect" from the "Start" menu.

How to Start and Close the Remote Desktop

To set up a connection to the R&S FPL1000

1. In the "Remote Desktop Connection" dialog box (see ["How to Configure the Controller"](#) on page 231), open the "General" tab.
2. In the "Computer" field, enter the IP address of the R&S FPL1000.
In the "User name" field, enter *instrument* to log in as an administrator, or *Normal User* to log in as a standard user.
In the "Password" field, enter *894129*.
3. To save the connection configuration for later use:
 - a) Select the "Save As" button.
The "Save As" dialog box is displayed.
 - b) Enter the name for the connection information (*.RDP).
4. To load an existing connection configuration:
 - a) Select the "Open" button.
The "Open" dialog box is displayed.
 - b) Select the *.RDP file.
5. Select the "Connect" button.
The connection is set up.
6. If the "Disk drives" option is activated on the "Local Resources" tab, a warning is displayed indicating that the drives are enabled for access from the R&S FPL1000. Select "OK" to confirm the warning.

7. After a few moments, the R&S FPL1000 screen is displayed.
If a dark screen appears or a dark square appears in the upper left-hand corner of the screen, you must restart the R&S FPL1000 in order to see the modified screen resolution.

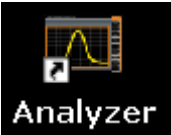
	<ul style="list-style-type: none"> • Press the key combination [ALT] + [F4]. • The R&S FPL1000 firmware is shut down, which may take a few seconds. • On the desktop, double-tap the "Analyzer" icon.
-----------------------------------------------------------------------------------	--------------------------------------------------------------------------------------------------------------------------------------------------------------------------------------------------------------------------------------------

The firmware restarts and then automatically opens the "Soft Front Panel", i.e. the user interface on which all front panel controls and the rotary knob are mapped to buttons.

For more information see [Chapter 7.3.2.3, "How to Work with the Soft Front Panels"](#), on page 140.

8. To deactivate or activate the "Softfrontpanel", press the [F6] key.
After the connection is established, the R&S FPL1000 screen is displayed in the "Remote Desktop" application window.

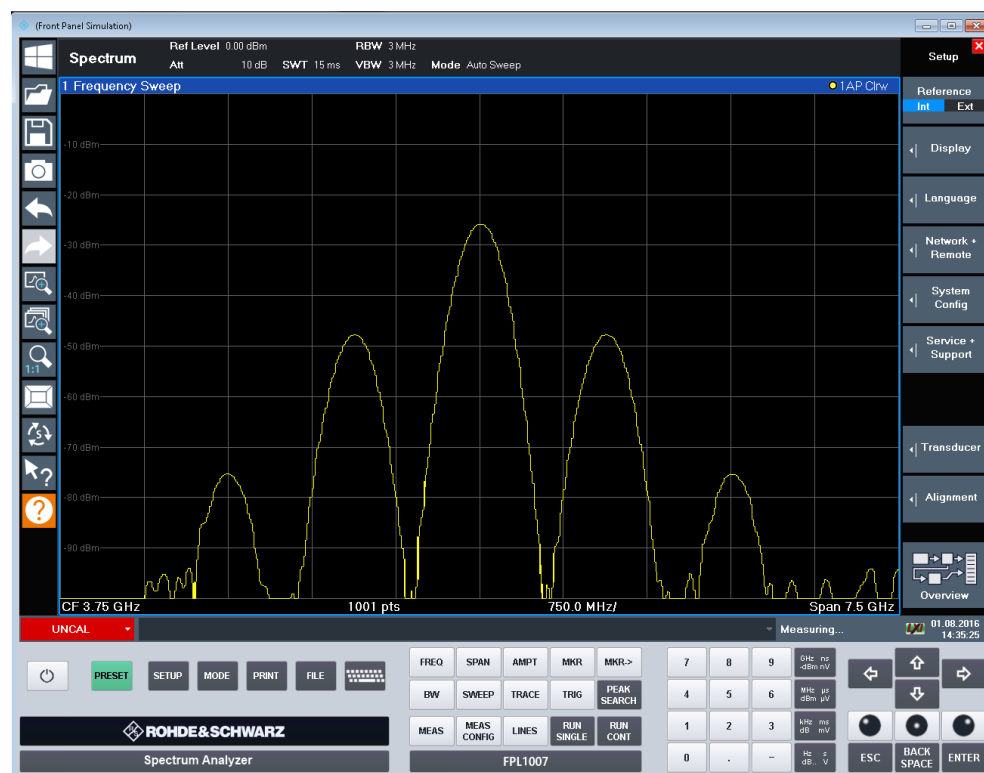

The Windows "Start" menu can be made available by expanding the "Remote Desktop" window to full size.

During the connection with the controller, the login entry is displayed on the R&S FPL1000 screen.

To terminate Remote Desktop control

The connection can be terminated by the controller or by a user at the R&S FPL1000:

1. On the controller, close the "Remote Desktop" window at any time.
The connection to the R&S FPL1000 is terminated.
2. On the R&S FPL1000, a user logs on.
The connection to the controller is terminated as a result. A message is displayed on the controller display indicating that another user has assumed control of the instrument.

Restoring the connection to the R&S FPL1000

Follow the instructions above for setting up a connection to the R&S FPL1000. If the connection is terminated and then restored, the R&S FPL1000 remains in the same state.

How to Shut Down the R&S FPL1000 via Remote Operation

1. Select the R&S FPL1000 softfrontpanel and close the application with the key combination [ALT] + [F4].
2. Select the desktop and press the key combination [ALT] + [F4].
A safety query is displayed to warn you that the instrument cannot be reactivated via remote operation and asks you whether you want to continue the shutdown process.
3. Respond to the safety query with "Yes".
The connection with the controller is terminated and the R&S FPL1000 is shut down.

7.4.4.8 How to Start a Remote Control Session from a PC

When you switch on the R&S FPL1000, it is always in manual operation state ("local" state) and can be operated via the front panel.

To start remote control

1. Send an addressed command (`GTR` - Go to Remote) from a controller to the instrument.

The instrument is switched to remote control ("remote" state). Operation via the front panel is disabled. Only the "Local" softkey is displayed to return to manual operation. The instrument remains in the remote state until it is reset to the manual state via the instrument or via remote control interfaces. Switching from manual operation to remote control and vice versa does not affect the other instrument settings.
2. During program execution, send the `SYSTem:DISPlay:UPDate ON` command to activate the display of results (see `SYSTem:DISPlay:UPDate` on page 905).

The changes in the device settings and the recorded measurement values are displayed on the instrument screen.

3. To obtain optimum performance during remote control, send the `SYSTem:DISPlay:UPDate OFF` command to hide the display of results and diagrams again (default setting in remote control).
4. To prevent unintentional return to manual operation, disable the keys of the instrument using the universal command `LLO`.

Switching to manual mode is only possible via remote control then. This function is only available for the GPIB interface.

5. To enable the keys of the R&S FPL1000 again, switch the instrument to local mode (`GTL` - Go to Local), i.e. deactivate the `REN` line of the remote control interface.



If the instrument is operated exclusively in remote control, it is recommended that you switch off the display. For details see ["Remote Display Update"](#) on page 210.

7.4.4.9 How to Return to Manual Operation

Before you switch back to manual operation, all remote command processing must be completed. Otherwise, the instrument will switch back to remote control immediately.

- ▶ Select the "Local" softkey, or use the following GPIB command:
`status = viGpibControlREN(vi, VI_GPIB_REN_ADDRESS_GTL)`



If you select the "Local" softkey while a self-alignment or a self-test is still running (which was started remotely), the instrument only returns to the manual operation state when the alignment or test is completed.

8 The Spectrum Application (RF Measurements)

The Spectrum application provides basic RF measurements in the frequency and time domain. The common settings for these measurements are described here.

- [Configuration Overview](#).....237
- [Measurements and Results](#)..... 239
- [Receiving Data Input and Providing Data Output](#)..... 409
- [Frequency and Span Configuration](#)..... 418
- [Amplitude and Vertical Axis Configuration](#)..... 426
- [Bandwidth, Filter and Sweep Configuration](#)..... 434
- [Trigger and Gate Configuration](#)..... 449
- [Adjusting Settings Automatically](#)..... 461
- [Marker Usage](#)..... 463
- [Trace Configuration](#)..... 503
- [Display and Limit Lines](#)..... 535
- [Zoomed Displays](#)..... 554
- [Importing and Exporting Measurement Results for Evaluation](#)..... 560
- [Optimizing Measurements](#)..... 571

8.1 Configuration Overview



Access: all menus

Each channel setup provides an overview of the most important currently defined settings and access to the most important configuration dialog boxes for the particular measurement. This overview is available via the "Overview" icon, which is displayed in all menus.

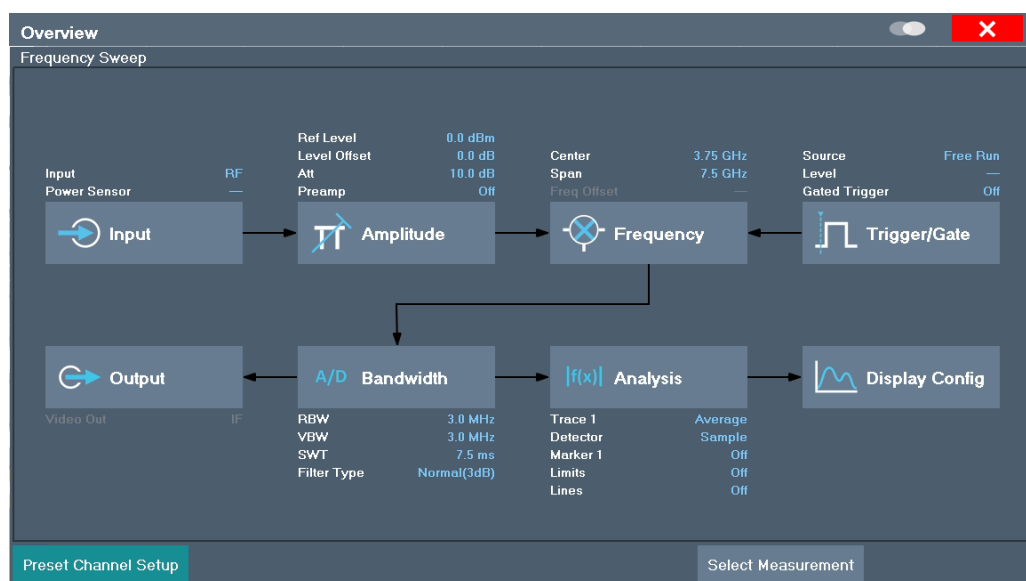

Using this overview, you can easily configure an entire channel setup from input over processing to output and analysis by stepping through the dialog boxes as indicated.

In particular, the "Overview" provides quick access to the following configuration dialog boxes (listed in the recommended order of processing):

1. "Select Measurement"
See [Chapter 8.2, "Measurements and Results"](#), on page 239
2. Input
See [Chapter 8.3.1, "Radio Frequency Input"](#), on page 409
3. Amplitude
See [Chapter 8.5, "Amplitude and Vertical Axis Configuration"](#), on page 426
4. Frequency
See [Chapter 8.4, "Frequency and Span Configuration"](#), on page 418
5. (Optionally:) Trigger/Gate
See [Chapter 8.7, "Trigger and Gate Configuration"](#), on page 449
6. Bandwidth
See [Chapter 8.6.2, "Bandwidth, Filter and Sweep Settings"](#), on page 440
(For SEM measurements: SEM Setup, see [Chapter 8.2.6.5, "SEM Configuration"](#), on page 308)
(For Spurious measurements: Spurious Setup, see [Chapter 8.2.7.4, "Spurious Emissions Measurement Configuration"](#), on page 338)
7. (Optionally:) Outputs
Requires option R&S FPL1-B5, see [Chapter 8.3.3, "Output Settings"](#), on page 417
8. Analysis
See [Chapter 8.10, "Trace Configuration"](#), on page 503 and [Chapter 8.9, "Marker Usage"](#), on page 463
9. Display
See [Chapter 6.6, "Configuring Result Displays"](#), on page 94

To configure settings

- ▶ Select any button to open the corresponding dialog box.
Select a setting in the channel setup bar (at the top of the channel setup tab) to change a specific setting.

Preset Channel Setup

Select the "Preset Channel" button in the lower left-hand corner of the "Overview" to restore all measurement settings **in the current channel setup** to their default values.

Do not confuse the "Preset Channel" button with the [Preset] key, which restores the entire instrument to its default values and thus closes **all channel setups** on the R&S FPL1000 (except for the default channel setup)!

Remote command:

`SYSTem:PRESet:CHANnel[:EXEC]` on page 876

8.2 Measurements and Results

Access: "Overview" > "Select Measurement"

Or: [MEAS]

In the Spectrum application, the R&S FPL1000 provides a variety of different measurement functions.

- **Basic measurements** - measure the spectrum of your signal or watch your signal in time domain
- **Power measurements** - calculate the powers involved in modulated carrier signals
- **Emission measurements** - detect unwanted signal emission
- **Statistic measurements** - evaluate the spectral distribution of the signal
- **Special measurements** - provide characteristic values of the signal
- **EMI measurements** - detect electromagnetic interference in the signal

The individual functions are described in detail in the following chapters.

The measurement function determines which settings, functions and evaluation methods are available in the R&S FPL1000. The various measurement functions are described in detail here.

When you select a measurement function, the measurement is started with its default settings immediately and the corresponding measurement configuration menu is displayed. The measurement configuration menu can be displayed at any time by pressing the [MEAS CONFIG] key.

The easiest way to configure measurements is using the configuration "Overview" , see [Chapter 8.1, "Configuration Overview"](#), on page 237.

In addition to the measurement-specific parameters, the general parameters can be configured as usual, see [Chapter 8, "The Spectrum Application \(RF Measurements\)"](#), on page 237. Many measurement functions provide special result displays or evaluation methods; however, in most cases the general evaluation methods are also available, see [Chapter 8.2.2, "Basic Evaluation Methods"](#), on page 260.

In addition to the measurement-specific parameters, the general parameters can be configured as usual, see [Chapter 8.1, "Configuration Overview"](#), on page 237. Many measurement functions provide special result displays or evaluation methods; however, in most cases the general evaluation methods are also available, see [Chapter 8.2.2, "Basic Evaluation Methods"](#), on page 260.

The remote commands required to retrieve measurement results are described in [Chapter 9.8.7.4, "Retrieving Trace Results"](#), on page 775.

- [Basic Measurements](#).....240
- [Basic Evaluation Methods](#).....260
- [Channel Power and Adjacent-Channel Power \(ACLR\) Measurement](#).....262
- [Carrier-to-Noise Measurements](#).....284
- [Occupied Bandwidth Measurement \(OBW\)](#).....288
- [Spectrum Emission Mask \(SEM\) Measurement](#).....294
- [Spurious Emissions Measurement](#).....334
- [Statistical Measurements \(APD, CCDF\)](#).....347

- [Time Domain Power Measurement](#).....361
- [Harmonic Distortion Measurement](#).....366
- [Third Order Intercept \(TOI\) Measurement](#)..... 372
- [AM Modulation Depth Measurement](#).....382
- [Electromagnetic Interference \(EMI\) Measurement](#)..... 385

8.2.1 Basic Measurements

Basic measurements are common sweeps in the time or frequency domain which provide an overview of the basic input signal characteristics.

If no other measurement function is selected, or if all measurement functions are switched off, the R&S FPL1000 performs a basic frequency or time sweep.

After a preset, a frequency sweep is performed.

Use the general measurement settings to configure the measurement, e.g. via the "Overview" (see [Chapter 8.1, "Configuration Overview"](#), on page 237).

8.2.1.1 Basic Measurement Types

Frequency Sweep	240
Zero Span	240
All Functions Off	241

Frequency Sweep

A common frequency sweep of the input signal over a specified span. Can be used for general purposes to obtain basic measurement results such as peak levels and spectrum traces. The "Frequency" menu is displayed. This is the default measurement if no other function is selected.

Use the general measurement settings to configure the measurement, e.g. via the "Overview" (see [Chapter 8.1, "Configuration Overview"](#), on page 237).

Remote command:

`[SENSe:]FREQuency:START` on page 716, `[SENSe:]FREQuency:STOP`
on page 716

`INITiate<n>[:IMMediate]` on page 590

`INITiate<n>:CONTInuous` on page 589

Zero Span

A sweep in the time domain at the specified (center) frequency, i.e. the frequency span is set to zero. The display shows the time on the x-axis and the signal level on the y-axis, as on an oscilloscope. On the time axis, the grid lines correspond to 1/10 of the current sweep time.

Use the general measurement settings to configure the measurement, e.g. via the "Overview" (see [Chapter 8.1, "Configuration Overview"](#), on page 237).

Most result evaluations can also be used for zero span measurements, although some functions (e.g. markers) may work slightly differently and some may not be available. If so, this will be indicated in the function descriptions (see [Chapter 8.2.2, "Basic Evaluation Methods"](#), on page 260).

Remote command:

[SENSe:]FREQuency:SPAN on page 715

INITiate<n>[:IMMediate] on page 590

INITiate<n>:CONTInuous on page 589

All Functions Off

Switches off all measurement functions and returns to a basic frequency sweep.

Selecting "Frequency Sweep" has the same effect.

8.2.1.2 How to Perform a Basic Sweep Measurement

The following step-by-step instructions demonstrate how to perform basic sweep measurements.



For remote operation, see [Chapter 9.6.16, "Programming Example: Performing a Basic Frequency Sweep"](#), on page 700.

To perform one or more single sweeps

1. Configure the frequency and span to be measured ("Frequency" dialog box, see [Chapter 8.4, "Frequency and Span Configuration"](#), on page 418).
2. Configure the number of sweeps to be performed in a single measurement ("Sweep Config" dialog box, see " [Sweep/Average Count](#) " on page 444).
3. If necessary, configure a trigger for the measurement ("Trigger/ Gate Config" dialog box, see [Chapter 8.7, "Trigger and Gate Configuration"](#), on page 449).
4. Define how the results are evaluated for display ("Trace" dialog box, see [Chapter 8.10.1.2, "Trace Settings"](#), on page 509).
5. If necessary, configure the vertical axis of the display ("Amplitude" dialog box, see [Chapter 8.5, "Amplitude and Vertical Axis Configuration"](#), on page 426).
6. To start the measurement, select one of the following:
 - [RUN SINGLE] key
 - "Single Sweep" softkey in the "Sweep" menu

The defined number of sweeps are performed, then the measurement is stopped. While the measurement is running, the [RUN SINGLE] key is highlighted. To abort the measurement, press the [RUN SINGLE] key again. The key is no longer highlighted. The results are not deleted until a new measurement is started.

7. To repeat the same number of sweeps without deleting the last trace, select the "Continue Single Sweep" softkey in the "Sweep" menu.

To start continuous sweeping

1. If you want to average the trace or search for a maximum over more (or less) than 10 sweeps, configure the "Sweep/Average Count" ("Sweep Config" dialog box, see " [Sweep/Average Count](#) " on page 444).
2. To start the measurement, select one of the following:
 - [RUN CONT] key
 - "Continuous Sweep" softkey in the "Sweep" menu

After each sweep is completed, a new one is started automatically. While the measurement is running, the [RUN CONT] key is highlighted. To stop the measurement, press the [RUN CONT] key again. The key is no longer highlighted. The results are not deleted until a new measurement is started.

8.2.1.3 Measurement Examples - Measuring a Sinusoidal Signal

One of the most common measurement tasks that can be handled using a signal analyzer is determining the level and frequency of a signal. When measuring an unknown signal, you can usually start with the presettings.

NOTICE**High input values**

If levels higher than +30 dBm (=1 W) are expected or are possible, a power attenuator must be inserted before the RF input of the analyzer. Otherwise, signal levels exceeding 30 dBm can damage the RF attenuator or the input mixer. The total power of all occurring signals must be taken into account.

Test setup

- Connect the RF output of the signal generator to the RF input of the R&S FPL1000.

Table 8-1: Signal generator settings (e.g. R&S SMW)

Frequency	128 MHz
Level	-30 dBm

- [Measuring the Level and Frequency Using Markers](#).....242
- [Measuring the Signal Frequency Using the Signal Counter](#)..... 244

Measuring the Level and Frequency Using Markers

The level and frequency of a sinusoidal signal can be measured easily using the marker function. The R&S FPL1000 always displays its amplitude and frequency at the marker position. The frequency measurement uncertainty is determined by the reference frequency of the R&S FPL1000, the resolution of the marker frequency display and the number of sweep points.

1. Select [PRESET] to reset the instrument.
2. Connect the signal to be measured to the "RF INPUT" connector on the R&S FPL1000.
3. Set the center frequency to *128 MHz*.
4. Reduce the frequency span to *1 MHz*.

Note: Coupled settings. When the frequency span is defined, the resolution bandwidth, the video bandwidth and the sweep time are automatically adjusted, because these functions are defined as coupled functions in the presettings.

5. Select [MKR] to activate marker 1 and automatically set it to the maximum of the trace.

The level and frequency values measured by the marker are displayed in the marker information at the top of the display.

Note: Performing a peak search. When a marker is initially activated, it automatically performs the peak search function (as shown in the example). If a marker was already active, select the [Peak Search] key or the "Peak" softkey in the [MKR >] menu in order to set the currently active marker to the maximum of the displayed signal.

Increasing the Frequency Resolution

The frequency resolution of the marker is determined by the resolution of the trace. A trace consists of 1001 trace points, i.e. if the frequency span is 1 MHz, each trace point represents a span of approximately 1 kHz. This corresponds to a maximum uncertainty of +/- 0.5 kHz.

You can increase the resolution of the trace by reducing the frequency span.

Reducing the frequency span to 10 kHz

- ▶ Reduce the frequency span to *10 kHz*.

The resolution of the trace is now approximately 10 Hz (10 kHz span / 1001 trace points), thus, the precision of the marker frequency display increases to approximately ±5 Hz.

Setting the Reference Level

The reference level is the level at the upper limit of the diagram. To achieve the widest dynamic range possible for a spectrum measurement, use the entire level span of the R&S FPL1000. In other words, the highest level that occurs in the signal should be located at the top edge of the diagram (= reference level) or immediately below it.



Low Reference Levels

If the selected reference level is lower than the highest signal that occurs in the spectrum, the signal path in the R&S FPL1000 is overloaded.

In this case, the message "IFOVL" is displayed in the error message field.

In the presettings, the value of the reference level is 0 dBm. If the input signal is -30 dBm, the reference level can be reduced by 30 dB without causing the signal path to be overloaded.

Reducing the reference level by 30 dB

- ▶ Set the reference level to *-30 dBm*.

The maximum of the trace is near the maximum of the measurement diagram. The increase in the displayed noise is not substantial. Thus, the distance between the signal maximum and the noise display (=dynamic range) has increased.

Setting the reference level with the help of a marker

You can also use a marker to shift the maximum value of the trace directly to the top edge of the diagram. If the marker is located at the maximum level of the trace (as in this example), the reference level can be moved to the marker level as follows:

1. Press the [MKR ->] key.
2. Select "Ref Lvl = Mkr Lvl" .

The reference level is set to the current marker level.

Measuring the Signal Frequency Using the Signal Counter

The built-in signal counter allows you to measure the frequency more accurately than measuring it with the marker. The frequency sweep is stopped at the marker, and the R&S FPL1000 measures the frequency of the signal at the marker position (see also [Chapter 8.9.4.1, "Precise Frequency \(Signal Count\) Marker"](#), on page 480).

In the following example, the frequency of the generator at 128 MHz is shown using the marker.

Prerequisite

Precise frequency measurements require a precise reference frequency. Therefore, an external reference frequency from the signal generator is used. Connect the signal generator's "Ref OUT" connector to the analyzer's "Ref IN" connector.

1. Select [PRESET] to reset the instrument.
2. Set the center frequency to *128 MHz*.
3. Set the frequency span to *1 MHz*.
4. Select "Setup" > "Reference" > "External Reference 10 MHz" to activate the external reference frequency.
5. Select [MKR] to activate marker 1 and automatically set it to the maximum of the trace.

The level and the frequency of the marker are displayed in the marker results in the diagram or the marker table.

6. Select [MKR FUNC] > "Signal Count" to activate the signal counter.

The result of the signal counter is displayed in the marker results.

7. If necessary, increase the resolution of the signal counter by selecting "Signal Count Resolution" (in the "Signal Count" menu).



Prerequisites for using the internal signal counter

In order to obtain a correct result when measuring the frequency with the internal signal counter, an RF sinusoidal signal or a spectral line must be available. The marker must be located more than 25 dB above the noise level to ensure that the specified measurement accuracy is adhered to.

8.2.1.4 Measurement Example – Measuring Levels at Low S/N Ratios

The minimum signal level a signal analyzer can measure is limited by its intrinsic noise. Small signals can be swamped by noise and therefore cannot be measured. For signals that are just above the intrinsic noise, the accuracy of the level measurement is influenced by the intrinsic noise of the R&S FPL1000.

The displayed noise level of a signal analyzer depends on its noise figure, the selected RF attenuation, the selected reference level, the selected resolution and video bandwidth and the detector.

For details see:

- [Chapter 8.5.1.2, "RF Attenuation"](#), on page 428
- [Chapter 8.5.1.1, "Reference Level"](#), on page 426
- [Chapter 8.6.1.1, "Separating Signals by Selecting an Appropriate Resolution Bandwidth"](#), on page 435
- [Chapter 8.6.1.2, "Smoothing the Trace Using the Video Bandwidth"](#), on page 436
- ["Mapping Samples to sweep Points with the Trace Detector"](#) on page 503

This measurement example shows the different factors influencing the S/N ratio.

Table 8-2: Signal generator settings (e.g. R&S SMW)

Frequency	128 MHz
Level	-95 dBm

1. Preset the R&S FPL1000.
2. Set the center frequency to *128 MHz*.
3. Set the span to *100 MHz*.
4. Set the reference level to *-30 dBm*.

The signal is measured with the auto peak detector and is completely hidden in the intrinsic noise of the R&S FPL1000.

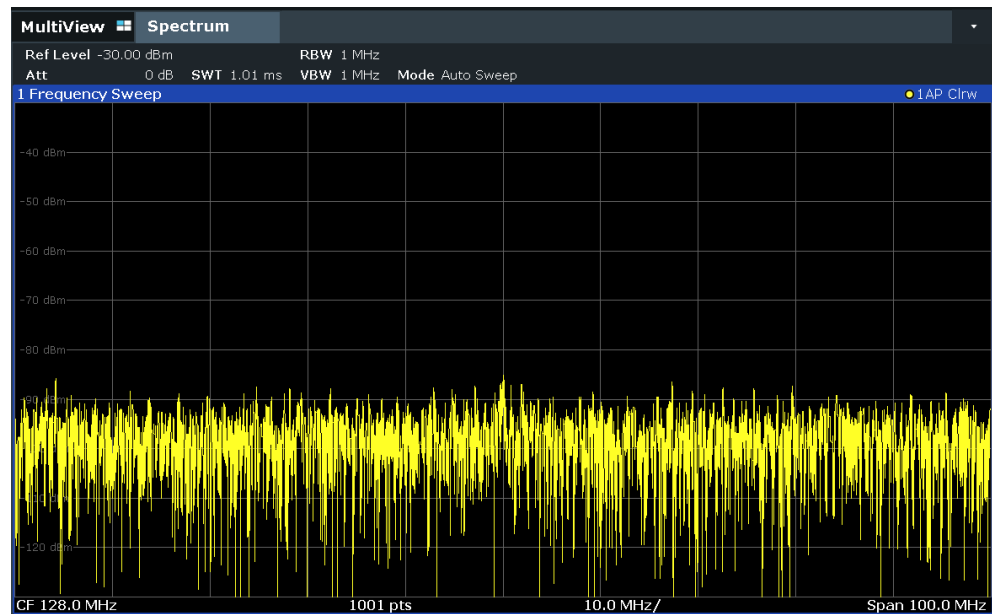

Figure 8-1: Sine wave signal with low S/N ratio

- To suppress noise spikes, average the trace. In the "Traces" configuration dialog, set the "Trace Mode" to "Average" (see "Trace Mode" on page 510).

The traces of consecutive sweeps are averaged. To perform averaging, the R&S FPL1000 automatically switches on the sample detector. The RF signal, therefore, can be more clearly distinguished from noise.

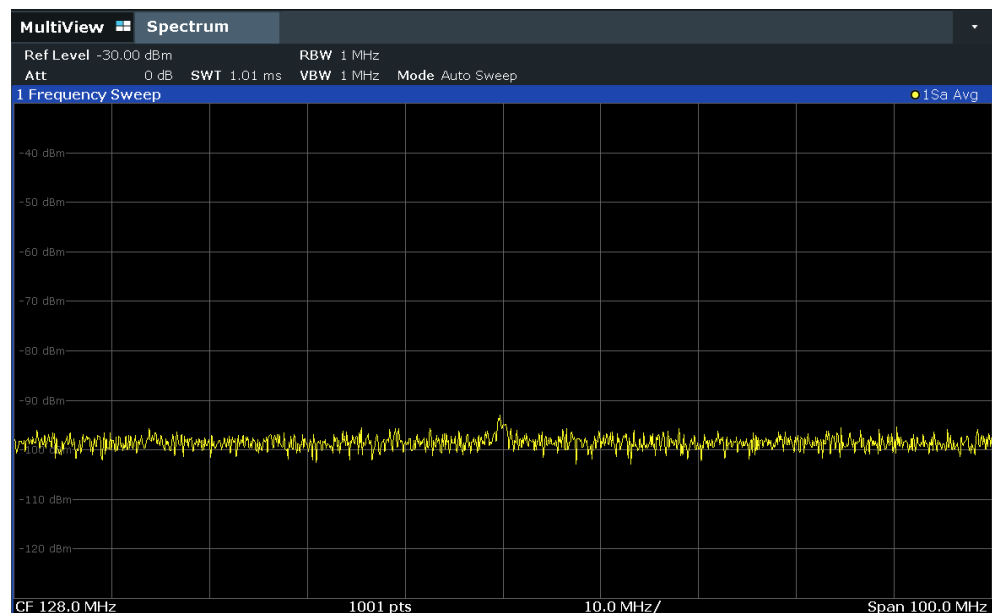

Figure 8-2: RF sine wave signal with low S/N ratio with an averaged trace

6. Instead of trace averaging, you can select a video filter that is narrower than the resolution bandwidth. Set the trace mode back to "Clear/ Write" , then set the VBW to 10 kHz manually in the "Bandwidth" configuration dialog.

The RF signal can be distinguished from noise more clearly.

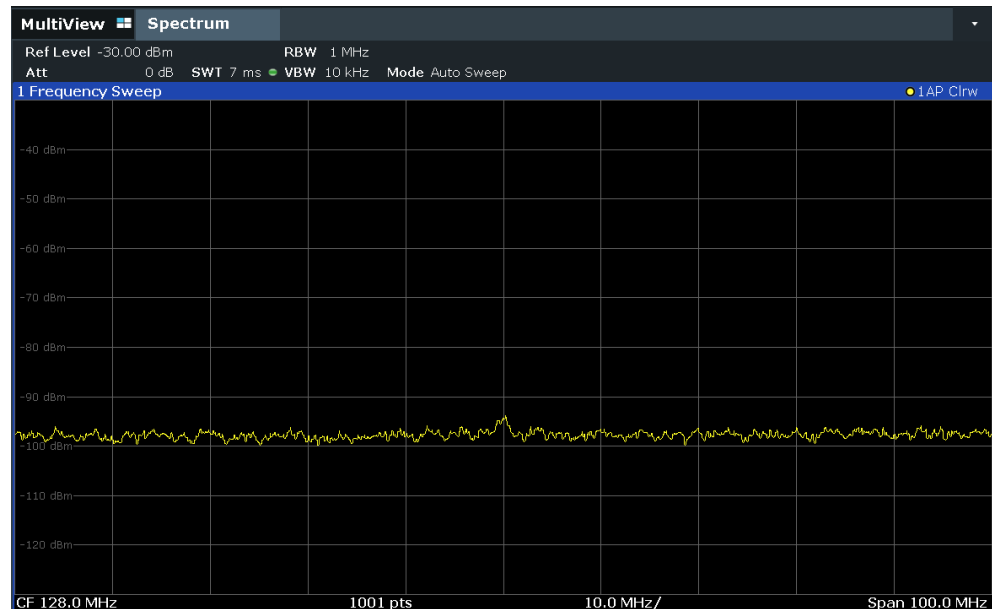

Figure 8-3: RF sine wave signal with low S/N ratio with a smaller video bandwidth

7. By reducing the resolution bandwidth by a factor of 10, the noise is reduced by 10 dB. Set the RBW to 100 kHz.

The displayed noise is reduced by approximately 10 dB. The signal, therefore, emerges from noise by about 10 dB. Compared to the previous setting, the video bandwidth has remained the same, i.e. it has increased relative to the smaller resolution bandwidth. The averaging effect of the video bandwidth is therefore reduced. The trace will be noisier.

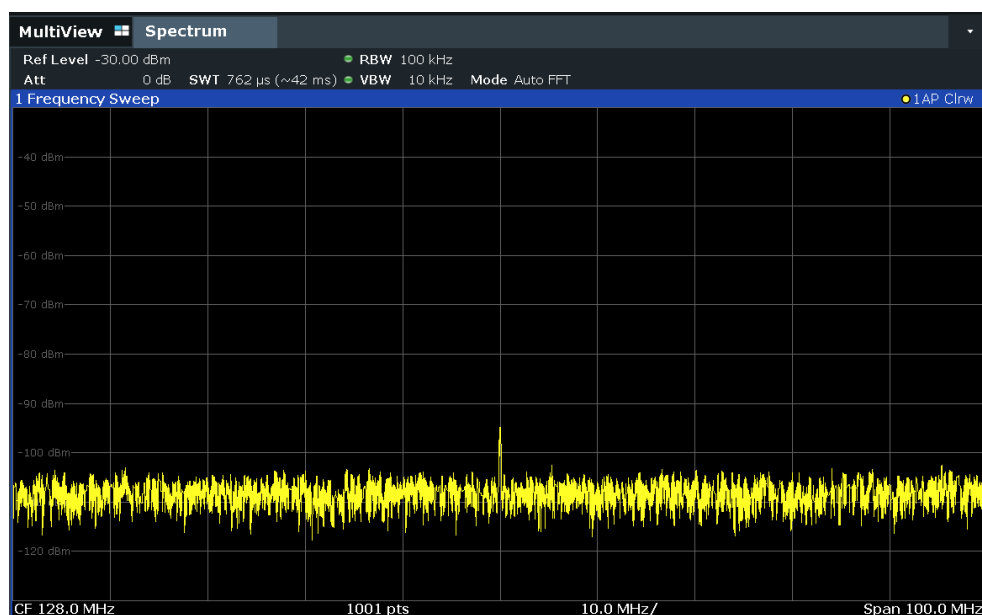

Figure 8-4: Reference signal at a smaller resolution bandwidth

8.2.1.5 Measurement Examples - Measuring Signal Spectra with Multiple Signals

- [Separating Signals by Selecting the Resolution Bandwidth](#)..... 248
- [Measuring the Modulation Depth of an AM-Modulated Carrier in the Frequency Domain](#).....252
- [Measuring AM-Modulated Signals](#).....253

Separating Signals by Selecting the Resolution Bandwidth

A basic feature of a Signal and Spectrum Analyzer is the ability to separate the spectral components of a mixture of signals. The resolution at which the individual components can be separated is determined by the resolution bandwidth. Selecting a resolution bandwidth that is too large may make it impossible to distinguish between spectral components, i.e. they are displayed as a single component (see also [Chapter 8.6.1.1, "Separating Signals by Selecting an Appropriate Resolution Bandwidth"](#), on page 435).

Two signals with the same amplitude can be resolved if the resolution bandwidth is smaller than or equal to the frequency spacing of the signal. If the resolution bandwidth is equal to the frequency spacing, the spectrum display shows a level drop of 3 dB precisely in the center of the two signals. Decreasing the resolution bandwidth makes the level drop larger, which thus makes the individual signals clearer.

In this measurement example we will analyze two signals with a level of -30 dBm each and a frequency spacing of 30 kHz.

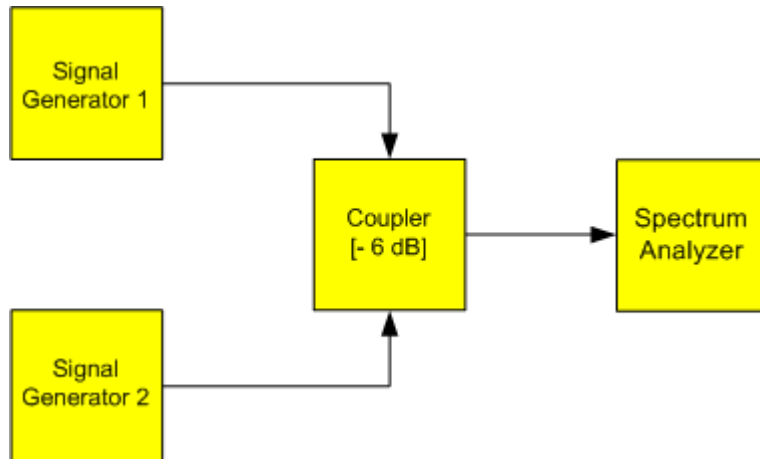

Figure 8-5: Test setup

Table 8-3: Signal generator settings (e.g. R&S SMW)

	Level	Frequency
Signal generator 1	-30 dBm	128,00 MHz
Signal generator 2	-30 dBm	128,03 MHz

1. Select [PRESET] to reset the instrument.
2. Set the center frequency to *128.015 MHz*.
3. Set the frequency span to *300 kHz*.
4. Set the resolution bandwidth to *30 kHz* and the video bandwidth to *1 kHz*.

Note: Larger video bandwidths. The video bandwidth is set to 1 kHz in order to make the level drop in the center of the two signals clearly visible. At larger video bandwidths, the video voltage that results from envelope detection is not sufficiently suppressed. This produces additional voltages, which are visible in the trace, in the transition area between the two signals.

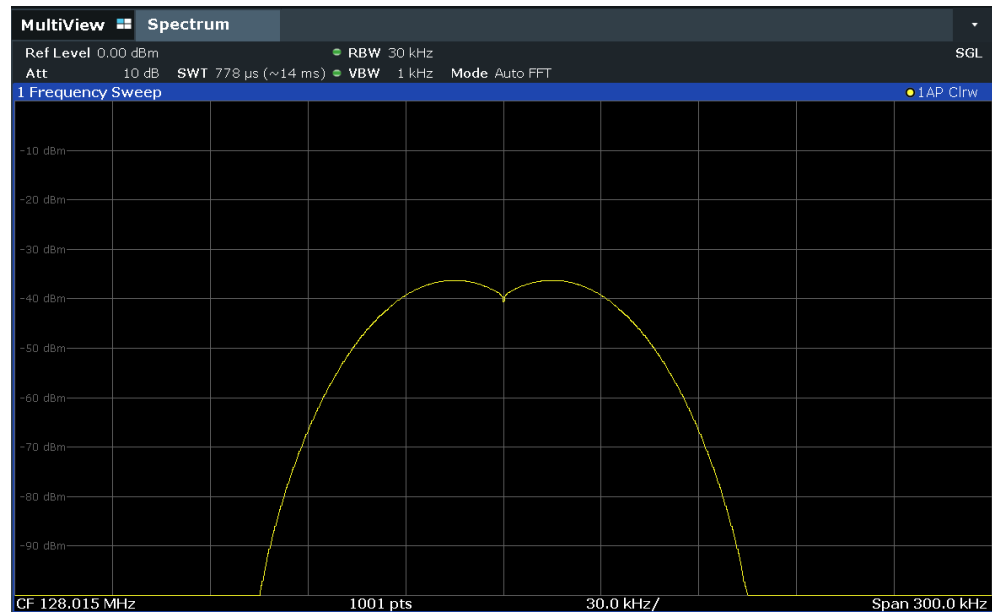

Figure 8-6: Measurement of two equally-leveled RF sinusoidal signals with the resolution bandwidth which corresponds to the frequency spacing of the signals

Matching generator and R&S FPL1000 frequencies

The level drop is located exactly in the center of the display only if the generator frequencies match the frequency display of the R&S FPL1000 exactly. To achieve exact matching, the frequencies of the generators and the R&S FPL1000 must be synchronized.

5. Set the resolution bandwidth to *100 kHz*.

It is no longer possible to clearly distinguish the two generator signals.

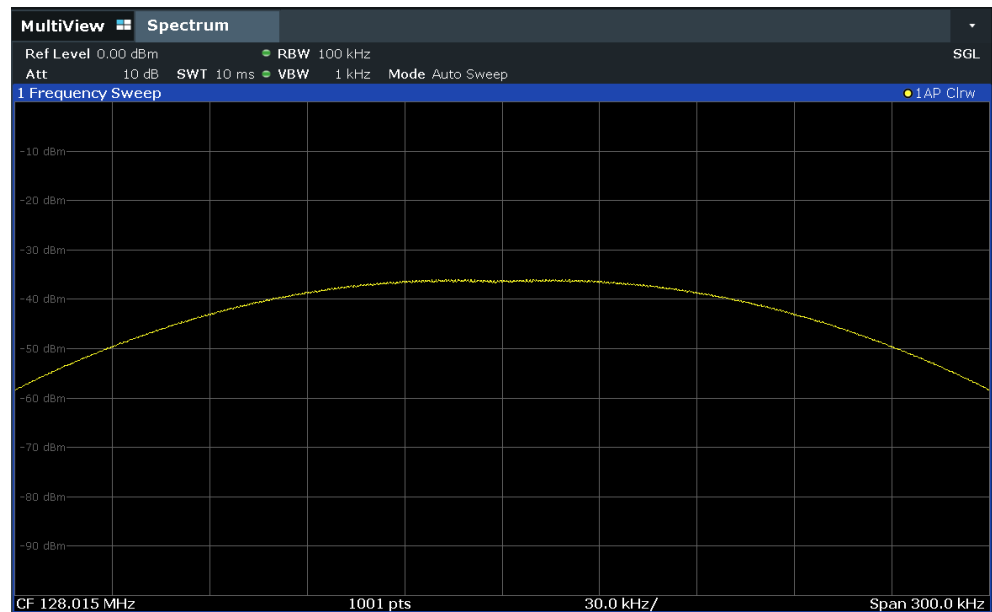

Figure 8-7: Measurement of two equally-leveled RF sinusoidal signals with a resolution bandwidth which is larger than their frequency spacing

6. Set the resolution bandwidth to 1 kHz.

The two generator signals are shown with high resolution. However, the sweep time becomes longer. At smaller bandwidths, the noise display decreases simultaneously (10 dB decrease in noise floor for a decrease in bandwidth by a factor of 10).

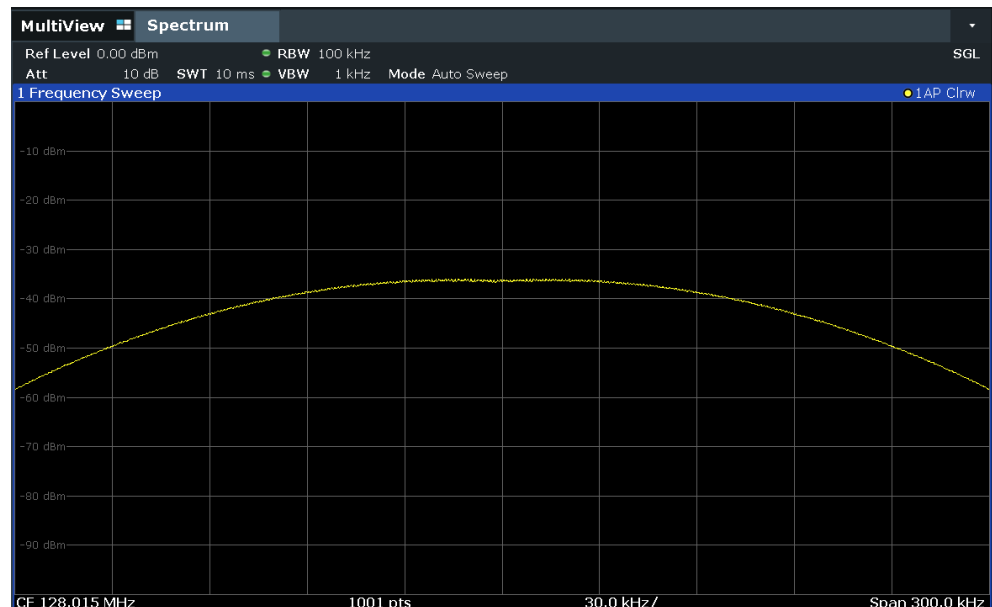

Figure 8-8: Measurement of two equally-leveled RF sinusoidal signals with a resolution bandwidth (1 kHz) which is significantly smaller than their frequency spacing

Measuring the Modulation Depth of an AM-Modulated Carrier in the Frequency Domain

In the frequency range display, the AM side bands can be resolved with a narrow bandwidth and measured separately. The modulation depth of a carrier modulated with a sinusoidal signal can then be measured. Since the dynamic range of a signal analyzer is very large, extremely small modulation depths can also be measured precisely. For this purpose, the R&S FPL1000 provides measurement routines that output the modulation depth numerically in percent directly.

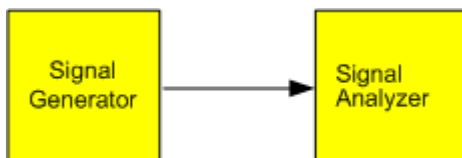

Figure 8-9: Test setup

Table 8-4: Signal generator settings (e.g. R&S SMW)

Frequency	128 MHz
Level	-30 dBm
Modulation	50 % AM, 10 kHz AF

1. Select [PRESET] to reset the instrument.
2. Set the center frequency to *128 MHz*.
3. Set the frequency span to *50 kHz*.
4. Select [MEAS] > "AM Modulation Depth" to activate the modulation depth measurement.

The R&S FPL1000 automatically sets a marker to the carrier signal in the center of the diagram and one delta marker each to the upper and lower AM sidebands. The R&S FPL1000 calculates the AM modulation depth from the level differences of the delta markers to the main marker and outputs the numeric value in the marker information.

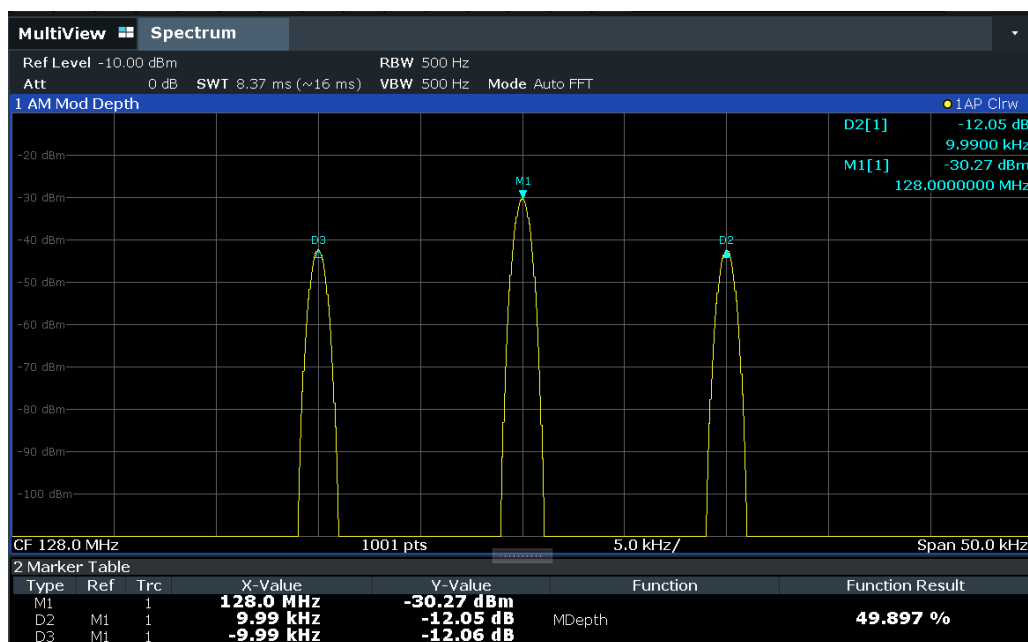

Figure 8-10: Measurement of the AM modulation depth

The modulation depth is displayed as "MDepth". The frequency of the AF signal can be obtained from the frequency display of the delta marker.

Measuring AM-Modulated Signals

The R&S FPL1000 rectifies the RF input signal (that is, removes the negative parts) and displays it as a magnitude spectrum. The rectification also demodulates AM-modulated signals. The AF voltage can be displayed in zero span if the modulation sidebands fall within the resolution bandwidth.

Displaying the AF of an AM-modulated signal (Zero Span)

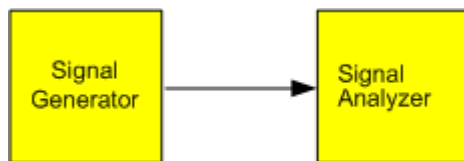

Figure 8-11: Test setup

Table 8-5: Signal generator settings (e.g. R&S SMW)

Frequency	128 MHz
Level	-30 dBm
Modulation	50 % AM, 1 kHz AF

1. Select [PRESET] to reset the instrument.
2. Set the center frequency to 128 MHz.
3. Set the frequency span to 0 Hz or select "Zero Span".

4. Set the sweep time to 2.5 ms.
5. Set the reference level to 6 dBm and the display range to linear ([AMPT] > "Scale Config" > "Scaling" : "Linear Percent").
6. Define triggering in response to the AF signal using the video trigger to produce a static image.
 - a) Press the [TRIG] key.
 - b) Select "Video" .
 - c) Set the "Trg/Gate Level" to 50%.

The trigger level is displayed as a horizontal line across the entire measurement diagram. The R&S FPL1000 displays the 1 kHz AF signal as a static image in zero span.

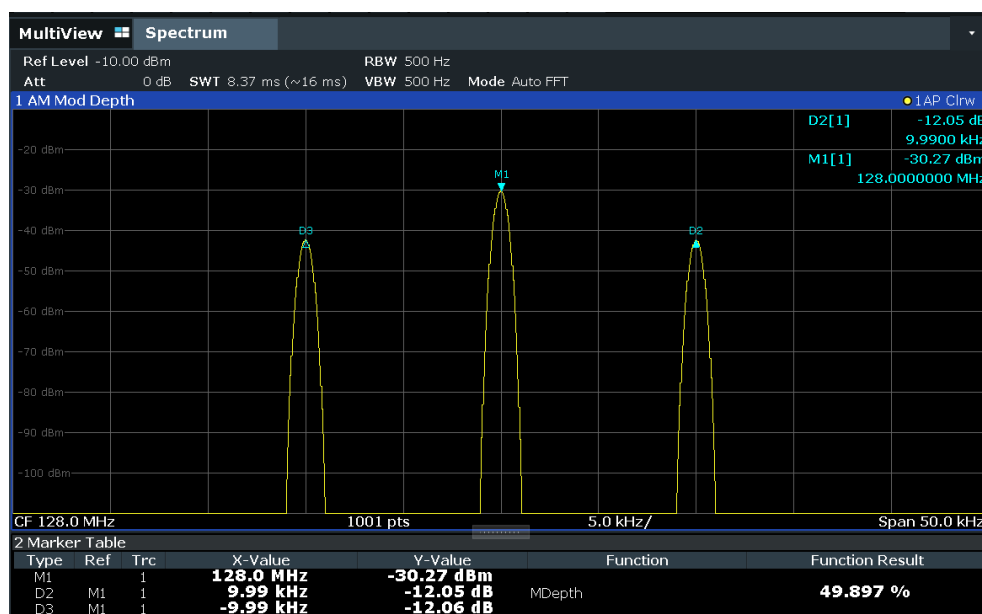

Figure 8-12: Measurement of the AF signal of a carrier that is AM-modulated with 1 kHz

7. Activate the internal AM demodulator to output the audio signal.
 - a) Press the [MKR FUNC] key.
 - b) Select "Marker Demodulation" .
The R&S FPL1000 automatically switches on the AM audio demodulator. A 1 kHz tone can be heard over headset (via the headphones connector). If necessary, use the volume control to turn up the volume.

8.2.1.6 Measurement Examples in Zero Span

For radio transmission systems that use the TDMA method (for example, GSM), transmission quality is determined not only by spectral characteristics but also by characteristics in zero span. A timeslot is assigned to each user since several users share the same frequency. Smooth operation is ensured only if all users adhere exactly to their assigned timeslots.

Both the power during the send phase as well as the timing and duration of the TDMA burst, and rise and fall times of the burst, are important.

- [Measuring the Power Characteristic of Burst Signals](#).....255
- [Measuring the Signal-to-Noise Ratio of Burst Signals](#).....258

Measuring the Power Characteristic of Burst Signals

To measure power in zero span, the R&S FPL1000 offers easy-to-use functions that measure the power over a predefined time.

Measuring the Power of a GSM Burst During the Activation Phase

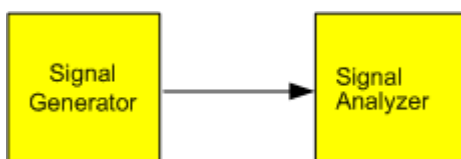

Figure 8-13: Test setup

Table 8-6: Signal generator settings (e.g. R&S SMW)

Frequency	890 MHz
Level	0 dBm
Modulation	GSM, one timeslot activated

1. Select [PRESET] to reset the instrument.
2. Set the center frequency to *890 MHz* ([FREQ]).
3. Set the frequency span to *0 Hz* ([SPAN] > "Zero Span").
4. Set the reference level to *10 dBm* (= level of the signal generator +10 dB) (AMPT).
5. Set the attenuation to *20 dB* ([AMPT] > "RF Atten Manual").
6. Set the resolution bandwidth to *1 MHz* ([BW] > "Res BW").
7. Set the sweep time to *1 ms* ([SWEEP] > "Sweep Time Manual").

The R&S FPL1000 shows the GSM burst continuously across the display.

8. Using the video trigger, set triggering on the rising edge of the burst.
 - a) Press the [TRIG] key.
 - b) Set the "Trg Source" to "Video" .
 - c) Set the "Trg/Gate Level" to *70%*.

The R&S FPL1000 shows a static image with the GSM burst at the start of the trace. The trigger level is displayed as a horizontal line labeled with the absolute level for the trigger threshold in the measurement diagram.

9. Activate power measurement within the activation phase of the burst in zero span.
 - a) Press the [MEAS] key.
 - b) Select "Time Domain Power" .

- c) Select "Time Dom Power Config" .
- d) Set the "Limits" state to "On" .
- e) Select the "Left Limit" input field.
- f) By turning the rotary knob clockwise, move the vertical line "S1" to the start of the burst.
- g) Select the "Right Limit" input field.
- h) By turning the rotary knob clockwise, move the vertical line "S2" to the end of the burst.

The R&S FPL1000 displays the average (mean) power during the activation phase of the burst.

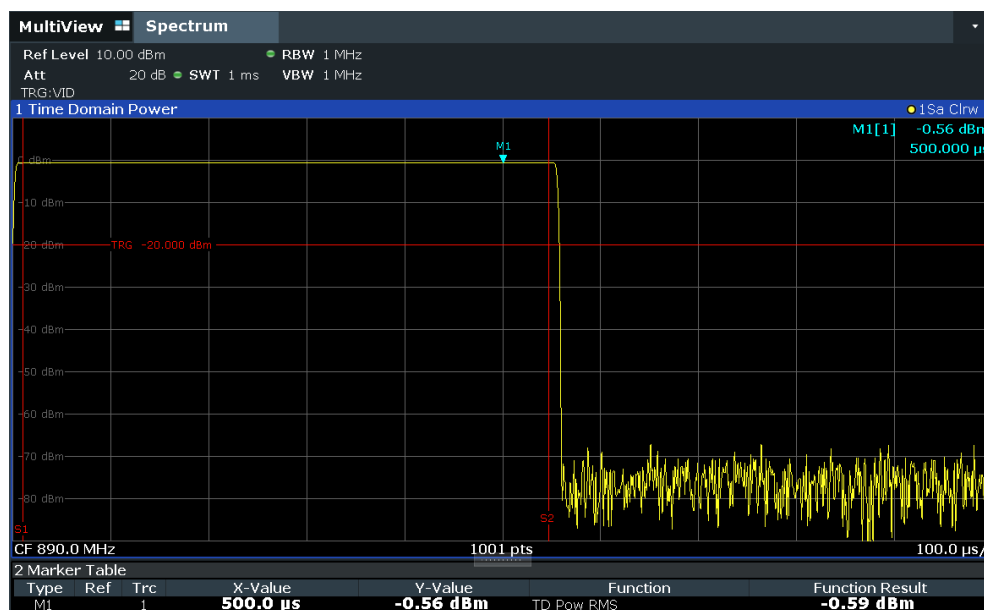

Figure 8-14: Measurement of the average power during the burst of a GSM signal

Measuring the Edges of a GSM Burst with High Time Resolution

Due to the high time resolution of the R&S FPL1000 at the 0 Hz display range, the edges of TDMA bursts can be measured precisely. The edges can be shifted to the display area using the trigger offset.

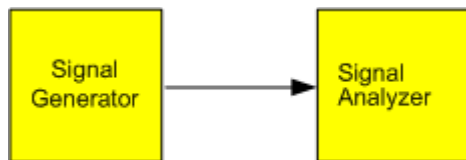

Figure 8-15: Test setup

Table 8-7: Signal generator settings (e.g. R&S SMW)

Frequency	890 MHz
Level	0 dBm
Modulation	GSM, one timeslot activated

The measurement is based on the example "Measuring the Power of a GSM Burst During the Activation Phase" on page 255.

1. Switch off the power measurement.
 - a) Press the [MEAS] key.
 - b) Select "Zero Span".
 2. Increase the time resolution by setting the sweep time to $100\ \mu\text{s}$ ([SWEEP] > "Sweep Time Manual").
 3. Shift the rising edge of the GSM burst to the center of the display by defining a trigger offset.
 - a) Press the [TRIG] key.
 - b) Select "Trigger Offset" .
 - c) By turning the rotary knob counterclockwise, reduce the trigger offset until the burst edge is displayed in the center of the display, or enter $-50\ \mu\text{s}$.
- The R&S FPL1000 displays the rising edge of the GSM burst.

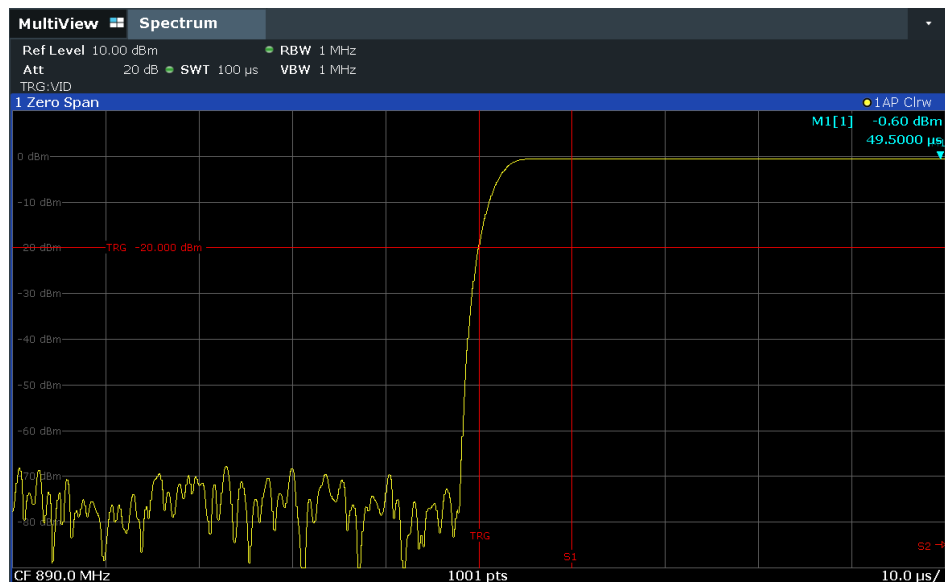

Figure 8-16: Rising edge of the GSM burst displayed with high time resolution

4. Move the falling edge of the burst to the center of the display. To do so, switch the trigger "Slope" to "Falling" ([TRIG] > "Trigger/ Gate Config").
- The R&S FPL1000 displays the falling edge of the GSM burst.

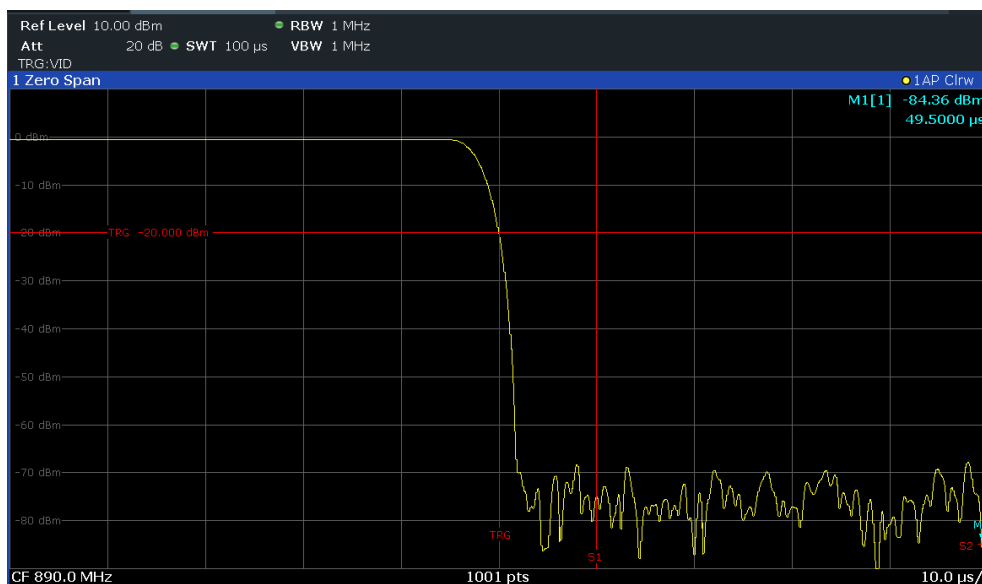

Figure 8-17: Falling edge of the GSM burst displayed with high time resolution

Measuring the Signal-to-Noise Ratio of Burst Signals

When TDMA transmission methods are used, the signal-to-noise ratio or the dynamic range for deactivation can be measured by comparing the power values during the activation phase and the deactivation phase of the transmission burst. Therefore, the R&S FPL1000 provides a measurement for absolute and relative power in zero span. In the following example, the measurement is performed using a GSM burst.

Signal-to-Noise Ratio of a GSM Signal

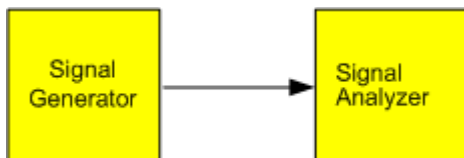

Figure 8-18: Test setup

Table 8-8: Signal generator settings (e.g. R&S SMW)

Frequency	890 MHz
Level	0 dBm
Modulation	GSM, one time slot is switched on

1. Select [PRESET] to reset the instrument.
2. Set the center frequency to 890 MHz.
3. Set the frequency span to 0 Hz.
4. Set the resolution bandwidth to 1 MHz.
5. Set the reference level to 0 dBm (= level of the signal generator).

6. Set the sweep time to 2 ms ([SWEEP] > "Sweep Time Manual").
The R&S FPL1000 shows the GSM burst continuously across the display.
7. Use the trigger source "Video" and the trigger slope "Rising" to trigger on the rising edge of the burst and shift the start of the burst to the center of the display (see [step 3](#) in "[Measuring the Edges of a GSM Burst with High Time Resolution](#)" on page 256).
8. Activate power measurement within the activation phase of the burst in zero span.
 - a) Press the [MEAS] key.
 - b) Select "Time Domain Power" .
 - c) Select "Time Dom Power Config" .
 - d) Set the "Limits" state to "On" .
 - e) Select the "Left Limit" input field.
 - f) By turning the rotary knob clockwise, move the vertical line "S1" to the start of the burst.
 - g) Select the "Right Limit" input field.
 - h) By turning the rotary knob clockwise, move the vertical line "S2" to the end of the burst.
 - i) Note down the power result for the burst, indicated by the "TD Pow RMS" result in the marker table.
9. Measure the power during the deactivation phase of the burst by switching the trigger slope to "Falling" ([TRIG] > "Trigger/ Gate Config").

The R&S FPL1000 initiates triggering in response to the falling edge of the burst. This shifts the burst to the left-hand side of the measurement diagram. The power is measured in the deactivation phase.

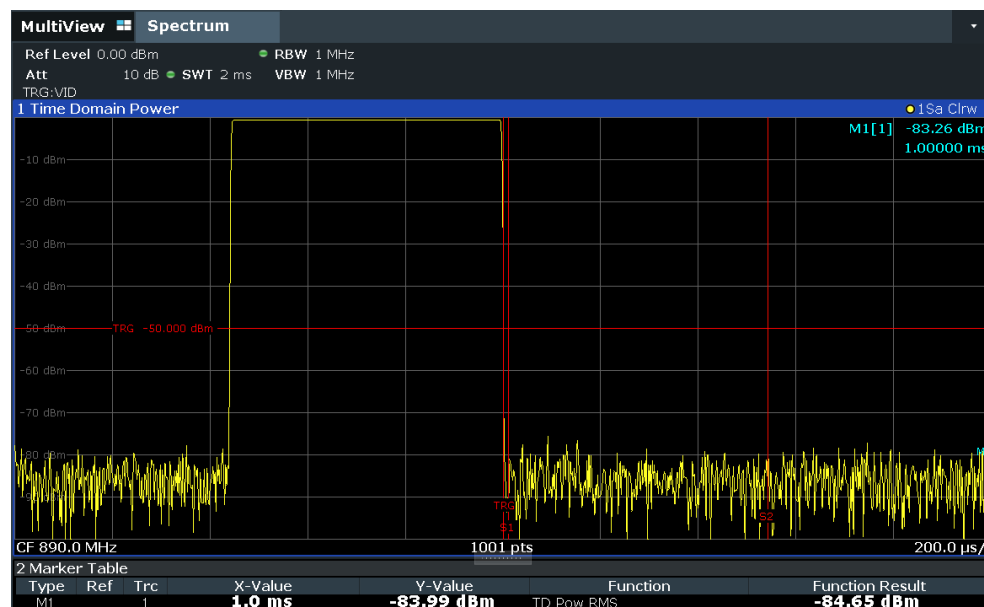

Figure 8-19: Measurement of the signal-to-noise ratio of a GSM burst signal in zero span

10. Note down the power result for the measured noise, indicated by the "TD Pow RMS" result in the marker table.

Subtract the measured noise power from the burst power to obtain the signal-to-noise ratio of the burst signal.

8.2.2 Basic Evaluation Methods

Measurement results can be displayed and evaluated using various different methods, also at the same time. Depending on the currently selected measurement, in particular when using optional firmware applications, not all evaluation methods are available.

The evaluation methods described here are available for most measurements in the Spectrum application.

Diagram	260
Marker Table	260
Marker Peak List	261
Result Summary	261
Spectrogram	262

Diagram

Displays a basic level vs. frequency or level vs. time diagram of the measured data to evaluate the results graphically. This is the default evaluation method. Which data is displayed in the diagram depends on the "Trace" settings. Scaling for the y-axis can be configured.

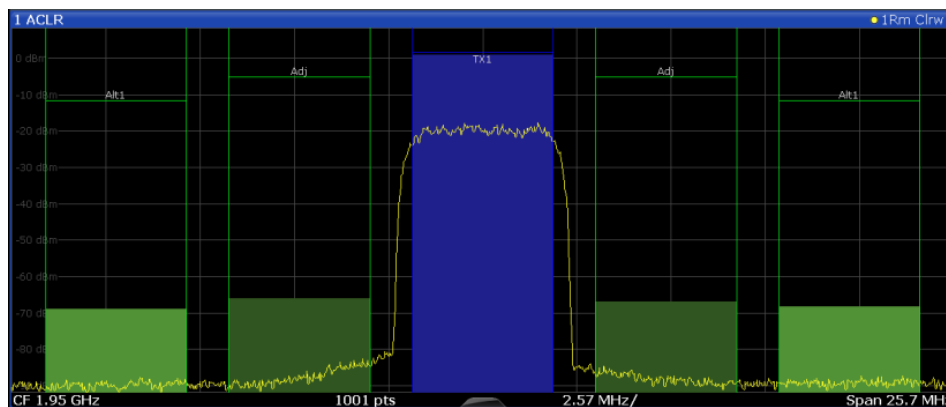

Remote command:

LAY:ADD? '1',RIGH, DIAG, see [LAYout:ADD\[:WINDow\]?](#) on page 703

Results:

[TRACe<n>\[:DATA\]](#) on page 776

Marker Table

Displays a table with the current marker values for the active markers.

This table is displayed automatically if configured accordingly (see "[Marker Table Display](#)" on page 470).

Tip: To navigate within long marker tables, simply scroll through the entries with your finger on the touchscreen.

Remote command:

LAY:ADD? '1',RIGH, MTAB, see LAYout:ADD[:WINDow]? on page 703

Results:

CALCulate<n>:MARKer<m>:X on page 789

CALCulate<n>:MARKer<m>:Y on page 803

Marker Peak List

The marker peak list determines the frequencies and levels of peaks in the spectrum or time domain. How many peaks are displayed can be defined, as well as the sort order. In addition, the detected peaks can be indicated in the diagram. The peak list can also be exported to a file for analysis in an external application.

You can define search and sort criteria to influence the results of the analysis.

3 Marker Peak List				
Wnd	No	X-Value	Y-Value	
2	1	1.086245 ms	-75.810 dBm	
2	2	2.172490 ms	-6.797 dBm	
2	3	3.258736 ms	-76.448 dBm	
2	4	4.831918 ms	-76.676 dBm	
2	5	6.255274 ms	-76.482 dBm	
2	6	6.798397 ms	-6.800 dBm	
2	7	9.233084 ms	-76.519 dBm	
2	8	10.075861 ms	-76.172 dBm	
2	9	11.405574 ms	-6.801 dBm	

Remote command:

LAY:ADD? '1',RIGH, PEAK, see LAYout:ADD[:WINDow]? on page 703

Results:

CALCulate<n>:MARKer<m>:X on page 789

CALCulate<n>:MARKer<m>:Y on page 803

Result Summary

Result summaries provide the results of specific measurement functions in a table for numerical evaluation. The contents of the result summary vary depending on the selected measurement function. See the description of the individual measurement functions for details.

2 Result Summary				
Channel	Bandwidth	Offset	Power	
Tx1 (Ref)	1.229 MHz		-0.86 dBm	
Tx Total			-0.86 dBm	
Channel	Bandwidth	Offset	Lower	Upper
Adj	30.000 kHz	750.000 kHz	-79.59 dB	-80.34 dB
Alt1	30.000 kHz	1.960 MHz	-85.04 dB	-83.85 dB

Remote command:

LAY:ADD? '1',RIGH, RSUM, see LAYout:ADD[:WINDow]? on page 703

Spectrogram

A spectrogram shows how the spectral density of a signal varies over time. The x-axis shows the frequency or sweep time, the y-axis shows the measurement time. A third dimension, the power level, is indicated by different colors. Thus you can see how the strength of the signal varies over time for different frequencies.

The spectrogram display consists of two diagrams: the standard spectrum result display (upper diagram) and the spectrogram result display (lower diagram).

For details see [Chapter 8.10.2.1, "Working with Spectrograms"](#), on page 515.

Remote command:

LAY:ADD? '1',RIGH, SGR, see [LAYout:ADD\[:WINDow\]?](#) on page 703

8.2.3 Channel Power and Adjacent-Channel Power (ACLR) Measurement

Measuring the power in channels adjacent to the carrier or transmission channel is useful to detect interference. The results are displayed as a bar chart for the individual channels.

• About Channel Power Measurements	262
• Channel Power Results	263
• Channel Power Basics	265
• Channel Power Configuration	269
• How to Perform Channel Power Measurements	277
• Measurement Examples	280
• Optimizing and Troubleshooting the Measurement	283
• Reference: Predefined CP/ACLR Standards	284

8.2.3.1 About Channel Power Measurements

Measuring channel power and adjacent channel power is one of the most important tasks during signal analysis with the necessary test routines in the field of digital transmission. Theoretically, a power meter could be used to measure channel power at highest accuracy. However, its low selectivity means that it is not suitable for measuring adjacent channel power as an absolute value or relative to the transmit channel power. Only a selective power meter can measure the power in the adjacent channels.

A signal analyzer cannot be classified as a true power meter, because it displays the IF envelope voltage. However, it is calibrated such as to display the power of a pure sine wave signal correctly, irrespective of the selected detector. This calibration cannot be applied for non-sinusoidal signals. Assuming that the digitally modulated signal has a Gaussian amplitude distribution, the signal power within the selected resolution bandwidth can be obtained using correction factors. The internal power measurement routines in a signal analyzer normally use these correction factors to determine the signal power from IF envelope measurements. These factors apply if and only if the assumption of a Gaussian amplitude distribution is correct.

Apart from this common method, the R&S FPL1000 also has a true power detector, i.e. an RMS detector. It displays the power of the test signal within the selected resolution bandwidth correctly, irrespective of the amplitude distribution, without additional correction factors being required.

The R&S FPL1000 software allows you to perform ACLR measurements on input containing multiple signals for different communication standards. A measurement standard is provided that allows you to define multiple discontinuous transmit channels at specified frequencies, independent from the selected center frequency. The ACLR measurement determines the power levels of the individual transmit, adjacent, and gap channels, as well as the total power for each sub block of transmit channels.

A detailed measurement example is provided in [Chapter 8.2.3.6, "Measurement Examples"](#), on page 280.

8.2.3.2 Channel Power Results

For channel or adjacent-channel power measurements, the individual channels are indicated by different colored bars in the diagram. The height of each bar corresponds to the measured power of that channel. In addition, the name of the channel ("Adj" , "Alt %1" , "Tx %1" , etc., or a user-defined name) is indicated above the bar (separated by a line which has no further meaning).

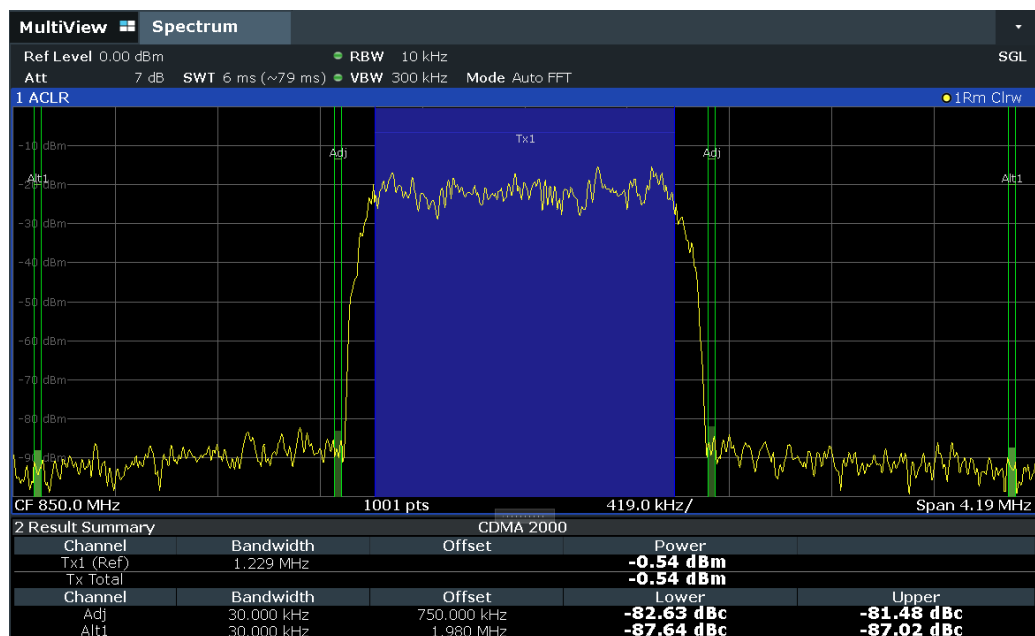

Results are provided for the TX channel and the number of defined adjacent channels *above and below* the TX channel. If more than one TX channel is defined, you must specify the channel to which the relative adjacent-channel power values refer. By default, it is the TX channel with the maximum power.

Table 8-9: Measurements performed depending on the number of adjacent channels

Number of adj. chan.	Measurement results
0	Channel powers
1	<ul style="list-style-type: none"> • Channel powers • Power of the upper and lower adjacent channel

Number of adj. chan.	Measurement results
2	<ul style="list-style-type: none"> • Channel powers • Power of the upper and lower adjacent channel • Power of the next higher and lower channel (alternate channel 1)
3	<ul style="list-style-type: none"> • Channel powers • Power of the upper and lower adjacent channel • Power of the next higher and lower channel (alternate channel 1) • Power of the second next higher and lower adjacent channel (alternate channel 2)
...	...
12	<ul style="list-style-type: none"> • Channel powers • Power of the upper and lower adjacent channel • Power of all the higher and lower channels (alternate channels 1 to 11)



In the R&S FPL1000 display, only the first neighboring channel of the carrier (TX) channel is labeled "Adj" (adjacent) channel; all others are labeled "Alt" (alternate) channels. In this manual, "Adjacent" refers to both adjacent and alternate channels.

The measured power values for the TX and adjacent channels are also output as a table in the Result Summary window. Which powers are measured depends on the number of configured channels.

For each channel, the following values are displayed:

Label	Description
Channel	Channel name as specified in the "Channel Settings" (see " Channel Names " on page 276).
Bandwidth	Configured channel bandwidth (see " Channel Bandwidth " on page 274)
Offset	Offset of the channel to the TX channel (configured channel spacing, see " Channel Bandwidth " on page 274)
Power (Lower/Upper)	The measured power values for the TX and lower and upper adjacent channels. The powers of the transmission channels are output in dBm or dBm/Hz, or in dBc, relative to the specified reference TX channel.

Retrieving Results via Remote Control

All or specific channel power measurement results can be retrieved using the `CALC:MARK:FUNC:POW:RES?` command from a remote computer (see [CALCulate<n>:MARKer<m>:FUNCTION:POWER<sb>:RESult?](#) on page 592). Alternatively, the results can be output as channel power density, i.e. in reference to the measurement bandwidth.

Furthermore, the measured power values of the displayed trace can be retrieved as usual using the `TRAC:DATA?` commands (see [TRACe<n>\[:DATA\]](#) on page 776). In this case, the measured power value for each sweep point (by default 1001) is returned.

For a full list of remote commands for ACLR measurements, see [Chapter 9.6.3.7, "Retrieving and Analyzing Measurement Results"](#), on page 609.

8.2.3.3 Channel Power Basics

Some background knowledge on basic terms and principles used in channel power measurements is provided here for a better understanding of the required configuration settings.

- [Recommended Common Measurement Parameters](#).....265

Recommended Common Measurement Parameters

The following sections provide recommendations on the most important measurement parameters for channel power measurements.



All instrument settings for the selected channel setup (channel bandwidth, channel spacing) can be optimized automatically using the "Adjust Settings" function (see ["Optimized Settings \(Adjust Settings \)"](#) on page 273).

The easiest way to configure a measurement is using the configuration "Overview", see [Chapter 8.1, "Configuration Overview"](#), on page 237.

- [Sweep Time](#) 265
- [Frequency Span](#).....266
- [Resolution Bandwidth \(RBW\)](#).....267
- [Video Bandwidth \(VBW\)](#).....267
- [Detector](#).....268
- [Trace Averaging](#).....268
- [Reference Level](#).....268

Sweep Time

The "Sweep Time" is selected depending on the desired reproducibility of results. Reproducibility increases with "Sweep Time" since power measurement is then performed over a longer time period. As a general approach, approximately 500 non-correlated measured values are required for a reproducibility of 0.5 dB. (That means: 95 % of the measurements are within 0.5 dB of the true measured value). Approximately 5000 measured values are required for a reproducibility of 0.1 dB (99 %). These values are valid for white noise. The measured values are considered as non-correlated if their time interval corresponds to the reciprocal of the measured bandwidth.

The number of A/D converter values, N, used to calculate the power, is defined by the "Sweep Time". The time per trace pixel for power measurements is directly proportional to the selected "Sweep Time".

If the sample detector is used, it is best to select the smallest "Sweep Time" possible for a given span and resolution bandwidth. The minimum time is obtained if the setting is coupled, that is: the time per measurement is minimal. Extending the measurement time does not have any advantages. The number of samples for calculating the power is defined by the number of trace points in the channel.

If the RMS detector is used, the selection of "Sweep Time" s can affect the repeatability of the measurement results. Repeatability is increased at longer "Sweep Time" s.

If the RMS detector is used, the number of samples can be estimated as follows:

Since only uncorrelated samples contribute to the RMS value, the number of samples can be calculated from the "Sweep Time" and the resolution bandwidth.

Samples can be assumed to be uncorrelated if sampling is performed at intervals of 1/ RBW. The number of uncorrelated samples is calculated as follows:

$$N_{\text{decorr}} = \text{SWT} * \text{RBW}$$

(N_{decorr} means uncorrelated samples)

The number of uncorrelated samples per trace pixel is obtained by dividing N_{decorr} by 1001 (= pixels per trace).

The "Sweep Time" can be defined using the softkey in the "Ch Power" menu or in the "Sweep" configuration dialog box (see " [Sweep Time](#) " on page 273).

Frequency Span

The frequency span must cover at least the channels to be measured plus a measurement margin of approximately 10 %.

If the frequency span is large in comparison to the channel bandwidth (or the adjacent-channel bandwidths) being analyzed, only a few points on the trace are available per channel. The calculated waveform for the used channel filter is less accurate, which has a negative effect on the measurement accuracy. It is therefore strongly recommended that you consider the described formulas when you select the frequency span.

The frequency span for the defined channel settings can be optimized. Use the "Adjust Settings" function in the "Ch Power" menu or the "General Settings" tab of the "ACLR Setup" dialog box (see "[Optimized Settings \(Adjust Settings \)](#)" on page 273). You can set the frequency span manually in the "Frequency" configuration dialog box.

(See [Chapter 8.4.4, "How To Define the Frequency Range"](#), on page 425.)

For channel power measurements the "Adjust Settings" function sets the frequency span as follows:

"(No. of transmission channels – 1) x transmission channel spacing + 2 x transmission channel bandwidth + measurement margin"

For adjacent-channel power measurements, the "Adjust Settings" function sets the frequency span as a function of the following parameters:

- Number of transmission channels
- Transmission channel spacing
- Adjacent-channel spacing
- Bandwidth of one of adjacent-channels ADJ, ALT1 or ALT2, whichever is furthest away from the transmission channels

"(No. of transmission channels – 1) * (transmission channel spacing + 2) * (adjacent-channel spacing + adjacent-channel bandwidth) + measurement margin"

The measurement margin is approximately 10 % of the value obtained by adding the channel spacing and the channel bandwidth.

Resolution Bandwidth (RBW)

It is important to suppress spectral components outside the channel to be measured, especially of the adjacent channels. At the same time, you expect an acceptable measurement speed. To fulfill both these requirements, the appropriate resolution bandwidth is essential. As a general approach, set the resolution bandwidth to values between 1 % and 4 % of the channel bandwidth.

If the spectrum within the channel to be measured and the spectrum around the channel has a flat characteristic, you can select a larger resolution bandwidth. In the standard setting, e.g. for standard IS95A REV at an adjacent channel bandwidth of 30 kHz, a resolution bandwidth of 30 kHz is used. This yields correct results since the spectrum near the adjacent channels normally has a constant level.

You can optimize the resolution bandwidth for the defined channel settings. Use the "Adjust Settings" function in the "Ch Power" menu or the "General Settings" tab of the "ACLR Setup" dialog box (see "[Optimized Settings \(Adjust Settings \)](#)" on page 273). You can set the RBW manually in the "Bandwidth" configuration dialog box, see "[RBW](#)" on page 401.

Except for the IS95 CDMA standards, the "Adjust Settings" function sets the resolution bandwidth (RBW) as a function of the channel bandwidth:

$$\text{"RBW"} \leq 1/40 \text{ of "Channel Bandwidth"}$$

The maximum resolution bandwidth (concerning the requirement $\text{RBW} \leq 1/40$) resulting from the available RBW steps (1, 3) is selected.

Video Bandwidth (VBW)

For a correct power measurement, the video signal must not be limited in bandwidth. A restricted bandwidth of the logarithmic video signal causes signal averaging and thus results in a too low indication of the power (-2.51 dB at very low video bandwidths). Thus, select the video bandwidth at least three times the resolution bandwidth:

$$\text{VBW} \geq 3 * \text{RBW}$$

For FFT sweeps, instead of increasing the VBW, you can also select the trace average mode "Power" to ensure correct power measurements (see "[Average Mode](#)" on page 512). Note that in power measurements this setting affects the VBW regardless of whether or not a trace is actually averaged.

The video bandwidth for the defined channel settings can be optimized. Use the "Adjust Settings" function in the "Ch Power" menu or the "General Settings" tab of the "ACLR Setup" dialog box (see "[Optimized Settings \(Adjust Settings \)](#)" on page 273). You can set the VBW manually in the "Bandwidth" configuration dialog box, see "[VBW](#)" on page 442.

The video bandwidth (VBW) is set as a function of the channel bandwidth (see formula above) and the smallest possible VBW with regard to the available step size is selected.

Detector

The RMS detector correctly indicates the power irrespective of the characteristics of the signal to be measured. The whole IF envelope is used to calculate the power for each measurement point. The IF envelope is digitized using a sampling frequency which is at least five times the resolution bandwidth which has been selected. Based on the sample values, the power is calculated for each measurement point using the following formula:

$$P_{RMS} = \sqrt{\frac{1}{N} \cdot \sum_{i=1}^N s_i^2}$$

Where:

s_i = linear digitized video voltage at the output of the A/D converter

N = number of A/D converter values per measurement point

P_{RMS} = power represented by a measurement point

When the power has been calculated, the power units are converted into decibels and the value is displayed as a measurement point.

In principle, the sample detector would be possible as well. Due to the limited number of measurement points used to calculate the power in the channel, the sample detector would yield less stable results.

The RMS detector can be set for the defined channel settings automatically. Use the "Adjust Settings" function in the "Ch Power" menu or the "General Settings" tab of the "ACLR Setup" dialog box (see "[Optimized Settings \(Adjust Settings \)](#)" on page 273). You can set the detector manually in the "Traces" configuration dialog box, see "[Detector](#)" on page 511.

Trace Averaging

Avoid averaging, which is often performed to stabilize the measurement results but leads to a level indication that is too low. The reduction in the displayed power depends on the number of averages and the signal characteristics in the channel to be measured.

The "Adjust Settings" function switches off trace averaging. You can deactivate the trace averaging manually in the "Traces" configuration dialog box, see "[Average Mode](#)" on page 512.

Reference Level

To achieve an optimum dynamic range, set the reference level so that the signal is as close to the reference level as possible without forcing an overload message. However, if the signal-to-noise ratio becomes too small, the dynamic range is also limited. The measurement bandwidth for channel power measurements is significantly smaller than the signal bandwidth. Thus, the signal path can be overloaded although the trace is still significantly below the reference level.



Selecting a predefined standard or automatically adjusting settings does not affect the reference level. The reference level can be set automatically using the "Auto Level" function in the [Auto Set] menu, or manually in the "Amplitude" menu.

8.2.3.4 Channel Power Configuration

Access: "Overview" > "Select Measurement" > "Channel Power ACLR" > "CP / ACLR Config"

Both Channel Power (CP) and Adjacent-Channel Power (ACLR) measurements are available.

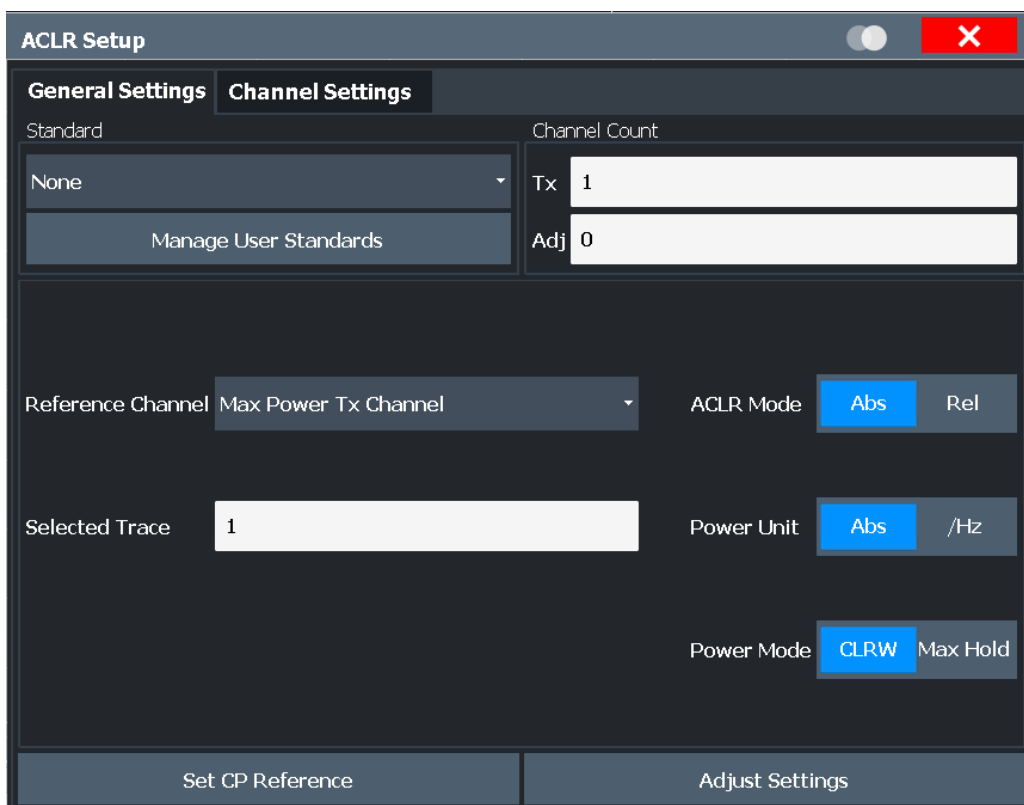

The remote commands required to perform these tasks are described in [Chapter 9.6.3, "Measuring the Channel Power and ACLR"](#), on page 595.

- [General CP/ACLR Measurement Settings](#).....269
- [Channel Setup](#)..... 274

General CP/ACLR Measurement Settings

General measurement settings are defined in the "ACLR Setup" dialog, in the "General Settings" tab.

Standard	270
L Predefined Standards	270
L User Standards	270
Number of channels: Tx , Adj	271

Reference Channel	272
Selected Trace	272
Absolute and Relative Values (ACLR Mode)	272
Channel power level and density (Power Unit).....	272
Power Mode	273
Setting a fixed reference for Channel Power measurements (Set CP Reference)...	273
Optimized Settings (Adjust Settings).....	273
Sweep Time	273

Standard

The main measurement settings can be stored as a standard file. When such a standard is loaded, the required channel and general measurement settings are automatically set on the R&S FPL1000. However, the settings can be changed. Predefined standards are available for standard measurements, but standard files with user-defined configurations can also be created.

Predefined Standards ← Standard

Predefined standards contain the main measurement settings for standard measurements. When such a standard is loaded, the required channel settings are automatically set on the R&S FPL1000. However, the settings can be changed.

The predefined standards contain the following settings:

- Channel bandwidths
- Channel spacings
- Detector
- Trace Average setting
- Resolution Bandwidth (RBW)
- Weighting Filter

Predefined standards can be selected via the "CP / ACLR Standard" softkey in the "Ch Power" menu or in the "General Settings" tab of the "CP / ACLR Config" dialog box.

For details on the available standards, see [Chapter 8.2.3.8, "Reference: Predefined CP/ACLR Standards"](#), on page 284.

Remote command:

`CALCulate<n>:MARKer<m>:FUNCTION:POWER<sb>:PRESet` on page 596

User Standards ← Standard

Access: "CP / ACLR Config" > "General Settings" tab > "Manage User Standards"

In addition to the predefined standards, you can save your own standards with your specific measurement settings in an XML file so you can use them again later. User-defined standards are stored on the instrument in the

`C:\ProgramData\Rohde-Schwarz\ZNL-FPL\acp_std` directory.

Note that ACLR user standards are not supported for multicarrier ACLR measurements.

Note: User standards created on an analyzer of the R&S FSP family are compatible to the R&S FPL1000. User standards created on an R&S FPL1000, however, are not necessarily compatible to the analyzers of the R&S FSP family and may not work there.

The following parameter definitions are saved in a user-defined standard:

- Number of adjacent channels
- Channel bandwidth of transmission (Tx), adjacent (Adj) and alternate (Alt) channels
- Channel spacings
- Weighting filters
- Resolution bandwidth
- Video bandwidth
- Detector
- ACLR limits and their state
- "Sweep Time" and "Sweep Time" coupling
- Trace and power mode

Save the current measurement settings as a user-defined standard, load a stored measurement configuration, or delete an existing configuration file.

For details see ["How to Manage User-Defined Configurations"](#) on page 279.

Remote command:

To query all available standards:

`CALCulate<n>:MARKer<m>:FUNCTION:POWER<sb>:STANDARD:CATALOG?`

on page 596

To load a standard:

`CALCulate<n>:MARKer<m>:FUNCTION:POWER<sb>:PRESet` on page 596

To save a standard:

`CALCulate<n>:MARKer<m>:FUNCTION:POWER<sb>:STANDARD:SAVE`

on page 597

To delete a standard:

`CALCulate<n>:MARKer<m>:FUNCTION:POWER<sb>:STANDARD:DELETE`

on page 597

Number of channels: Tx , Adj

Up to 18 carrier channels and up to 12 adjacent channels can be defined.

Results are provided for the Tx channel and the number of defined adjacent channels *above and below* the Tx channel. If more than one Tx channel is defined, the carrier channel to which the relative adjacent-channel power values should be referenced must be defined (see ["Reference Channel"](#) on page 272).

Note: If several carriers (Tx channels) are activated for the measurement, the number of sweep points is increased to ensure that adjacent-channel powers are measured with adequate accuracy.

For more information on how the number of channels affects the measured powers, see [Chapter 8.2.3.2, "Channel Power Results"](#), on page 263.

Remote command:

Number of Tx channels:

`[SENSe:]POWER:ACHannel:TXChannel:COUNT` on page 600

Number of Adjacent channels:

`[SENSe:]POWER:ACHannel:ACPairs` on page 598

Reference Channel

The measured power values in the adjacent channels can be displayed relative to the transmission channel. If more than one Tx channel is defined, define which one is used as a reference channel.

Tx Channel 1	Transmission channel 1 is used.
Min Power Tx Channel	The transmission channel with the lowest power is used as a reference channel.
Max Power Tx Channel	The transmission channel with the highest power is used as a reference channel (Default).
Lowest & Highest Channel	The outer left-hand transmission channel is the reference channel for the lower adjacent channels, the outer right-hand transmission channel that for the upper adjacent channels.

Remote command:

[\[SENSe:\]POWer:ACHannel:REference:TXChannel:MANual](#) on page 603

[\[SENSe:\]POWer:ACHannel:REference:TXChannel:AUTO](#) on page 603

Selected Trace

The CP/ACLR measurement can be performed on any active trace.

Remote command:

[\[SENSe:\]POWer:TRACe](#) on page 595

Absolute and Relative Values (ACLR Mode)

The powers of the adjacent channels are output in dBm or dBm/Hz (absolute values), or in dBc, relative to the specified reference Tx channel.

"Abs" The absolute power in the adjacent channels is displayed in the unit of the y-axis, e.g. in dBm, dBμV.

"Rel" The level of the adjacent channels is displayed relative to the level of the transmission channel in dBc.

Remote command:

[\[SENSe:\]POWer:ACHannel:MODE](#) on page 610

Channel power level and density (Power Unit)

By default, the channel power is displayed in absolute values. If "/Hz" is activated, the channel power density is displayed instead. Thus, the absolute unit of the channel power is switched from dBm to dBm/Hz.

Note: The channel power density in dBm/Hz corresponds to the power inside a bandwidth of 1 Hz and is calculated as follows:

"channel power density = channel power – log₁₀(channel bandwidth)"

Thus you can measure the signal/noise power density, for example, or use the additional functions [Absolute and Relative Values \(ACLR Mode\)](#) and [Reference Channel](#) to obtain the signal to noise ratio.

Remote command:

[CALCulate<n>:MARKer<m>:FUNCTION:POWer<sb>:RESult:PHZ](#) on page 610

Power Mode

The measured power values can be displayed directly for each trace ("Clear/ Write"), or only the maximum values over a series of measurements can be displayed ("Max Hold"). In the latter case, the power values are calculated from the current trace and compared with the previous power value using a maximum algorithm. The higher value is retained. If "Max Hold" mode is activated, "Pwr Max" is indicated in the table header. Note that the *trace* mode remains unaffected by this setting.

Remote command:

`CALCulate<n>:MARKer<m>:FUNCTION:POWER<sb>:MODE` on page 591

Setting a fixed reference for Channel Power measurements (Set CP Reference)

If only one Tx channel and no adjacent channels are defined, the currently measured channel power can be used as a fixed reference value for subsequent channel power measurements.

When you select this button, the channel power currently measured on the Tx channel is stored as a fixed reference power. In the following channel power measurements, the power is indicated relative to the fixed reference power. The reference value is displayed in the "Reference" field (in relative ACLR mode); the default value is 0 dBm.

Note: In adjacent-channel power measurement, the power is always referenced to a transmission channel (see " Reference Channel " on page 272), thus, this function is not available.

Remote command:

`[SENSe:]POWER:ACHannel:REFERENCE:AUTO ONCE` on page 603

Optimized Settings (Adjust Settings)

All instrument settings for the selected channel setup (channel bandwidth, channel spacing) can be optimized automatically.

The adjustment is carried out only once. If necessary, the instrument settings can be changed later.

The following settings are optimized by "Adjust Settings" :

- "Frequency Span" on page 266
- "Resolution Bandwidth (RBW)" on page 267
- "Video Bandwidth (VBW)" on page 267
- "Detector" on page 268
- "Trace Averaging" on page 268

Remote command:

`[SENSe:]POWER:ACHannel:PRESet` on page 594

Sweep Time

With the RMS detector, a longer "Sweep Time" increases the stability of the measurement results. For recommendations on setting this parameter, see " Sweep Time " on page 265.

The "Sweep Time" can be set via the softkey in the "Ch Power" menu and is identical to the general setting in the "Sweep" configuration dialog box.

Remote command:

`[SENSe:]SWEep:TIME` on page 728

Channel Setup

The "Channel Settings" tab in the "ACLR Setup" dialog box provides all the channel settings to configure the channel power or ACLR measurement. You can define the channel settings for all channels, independent of the defined number of *used* Tx or adjacent channels (see " [Number of channels: Tx , Adj](#) " on page 271).

For details on setting up channels, see "[How to Set Up the Channels](#)" on page 277.



In addition to the specific channel settings, the general settings " [Standard](#) " on page 270 and " [Number of channels: Tx , Adj](#) " on page 271 are also available in this tab.

The following settings are available in individual subtabs of the "Channel Settings" tab.

Channel Bandwidth	274
Channel Spacings	275
Limit Check	275
Weighting Filters	276
Channel Names	276

Channel Bandwidth

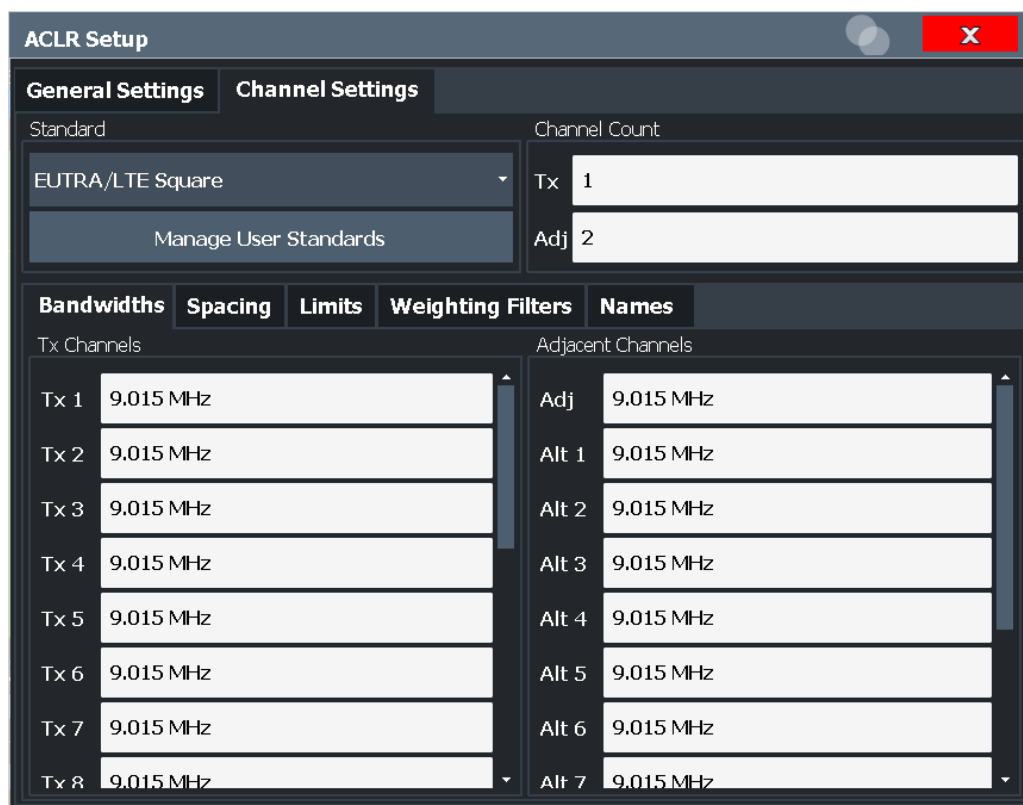

The Tx channel bandwidth is normally defined by the transmission standard.

The correct bandwidth is set automatically for the selected standard. The bandwidth for each channel is indicated by a colored bar in the display.

The value entered for any Tx channel is automatically also defined for all subsequent Tx channels. Thus, only enter one value if all Tx channels have the same bandwidth.

The value entered for any ADJ or ALT channel is automatically also defined for all alternate (ALT) channels. Thus, only enter one value if all adjacent channels have the same bandwidth.

Remote command:

[SENSe:] POWer:ACHannel:BANDwidth[:CHANnel<ch>] on page 598

[SENSe:] POWer:ACHannel:BANDwidth:ACHannel on page 598

[SENSe:] POWer:ACHannel:BANDwidth:ALternate<ch> on page 598

Channel Spacings

Channel spacings are normally defined by the transmission standard but can be changed.

If the spacings are not equal, the channel distribution in relation to the center frequency is as follows:

Odd number of Tx channels	The middle Tx channel is centered to center frequency.
Even number of Tx channels	The two Tx channels in the middle are used to calculate the frequency between those two channels. This frequency is aligned to the center frequency.

The spacings between all Tx channels can be defined individually. When you change the spacing for one channel, the value is automatically also defined for all subsequent Tx channels. This allows you to set up a system with equal Tx channel spacing quickly. For different spacings, set up the channels from top to bottom.

Tx1-2	Spacing between the first and the second carrier
Tx2-3	Spacing between the second and the third carrier
...	...

If you change the adjacent-channel spacing (ADJ), all higher adjacent channel spacings (ALT1, ALT2, ...) are multiplied by the same factor (new spacing value/old spacing value). Again, only enter one value for equal channel spacing. For different spacing, configure the spacings from top to bottom.

For details, see ["How to Set Up the Channels"](#) on page 277

Remote command:

[SENSe:] POWer:ACHannel:SPACing:CHANnel<ch> on page 600

[SENSe:] POWer:ACHannel:SPACing[:ACHannel] on page 599

[SENSe:] POWer:ACHannel:SPACing:ALternate<ch> on page 600

Limit Check

During an ACLR measurement, the power values can be checked whether they exceed user-defined or standard-defined limits. A relative or absolute limit can be defined, or both. Both limit types are considered, regardless whether the measured levels are absolute or relative values. The check of both limit values can be activated independently. If any active limit value is exceeded, the measured value is displayed in red and marked by a preceding asterisk in the result table.

2 Result Summary			W-CDMA 3GPP DL			
Tx Power 30.54 dBm		Tx Bandwidth 3.840 MHz		RBW 1.000 MHz		
Range Low	Range Up	RBW	Frequency	Power Abs	Power Rel	ΔLimit
-12.750 MHz	-8.000 MHz	1.000 MHz	2.09053 GHz	-40.68 dBm	-71.22 dB	-17.18 dB
-8.000 MHz	-4.000 MHz	1.000 MHz	2.09268 GHz	-40.13 dBm	-70.67 dB	-20.63 dB
-4.000 MHz	-3.515 MHz	30.000 kHz	2.09647 GHz	-52.60 dBm	-83.14 dB	-20.10 dB
-3.515 MHz	-2.715 MHz	30.000 kHz	2.09652 GHz	-54.30 dBm	-84.84 dB	-22.38 dB
-2.715 MHz	-2.515 MHz	30.000 kHz	2.09728 GHz	-51.51 dBm	-82.05 dB	-31.01 dB
2.515 MHz	2.715 MHz	30.000 kHz	2.10270 GHz	-54.13 dBm	-84.67 dB	-33.63 dB
2.715 MHz	3.515 MHz	30.000 kHz	2.10299 GHz*	-17.29 dBm*	-47.83 dB*	7.27 dB*
3.515 MHz	4.000 MHz	30.000 kHz	2.10355 GHz	-51.94 dBm	-82.48 dB	-19.44 dB
4.000 MHz	8.000 MHz	1.000 MHz	2.10725 GHz	-40.01 dBm	-70.55 dB	-20.51 dB
8.000 MHz	12.750 MHz	1.000 MHz	2.10911 GHz	-40.28 dBm	-70.82 dB	-16.78 dB

The results of the power limit checks are also indicated in the STAT:QUES:ACPL status registry (see "STATus:QUESTIONable:ACPLimit Register" on page 195).

Remote command:

CALCulate<n>:LIMit:ACPower[:STATe] on page 609

CALCulate<n>:LIMit:ACPower:ACHannel:ABSolute:STATe on page 604

CALCulate<n>:LIMit:ACPower:ACHannel:ABSolute on page 604

CALCulate<n>:LIMit:ACPower:ACHannel[:RELative]:STATe

on page 606

CALCulate<n>:LIMit:ACPower:ACHannel[:RELative] on page 605

CALCulate<n>:LIMit:ACPower:ALternate<ch>:ABSolute:STATe

on page 607

CALCulate<n>:LIMit:ACPower:ALternate<ch>:ABSolute on page 606

CALCulate<n>:LIMit:ACPower:ALternate<ch>[:RELative]:STATe

on page 608

CALCulate<n>:LIMit:ACPower:ALternate<ch>[:RELative]

on page 607

CALCulate<n>:LIMit:ACPower:ACHannel:RESult? on page 605

Weighting Filters

Weighting filters allow you to determine the influence of individual channels on the total measurement result. For each channel you can activate or deactivate the use of the weighting filter and define an individual weighting factor ("Alpha:" value).

Weighting filters are not available for all supported standards and cannot always be defined manually where they are available.

Remote command:

Activating/Deactivating:

[SENSe:] POWER:ACHannel:FILTer[:STATe]:CHANnel<ch> on page 602

[SENSe:] POWER:ACHannel:FILTer[:STATe]:ACHannel on page 602

[SENSe:] POWER:ACHannel:FILTer[:STATe]:ALternate<ch> on page 602

Alpha value:

[SENSe:] POWER:ACHannel:FILTer:ALPHa:CHANnel<ch> on page 602

[SENSe:] POWER:ACHannel:FILTer:ALPHa:ACHannel on page 601

[SENSe:] POWER:ACHannel:FILTer:ALPHa:ALternate<ch> on page 601

Channel Names

In the R&S FPL1000's display, carrier channels are labeled "Tx" by default; the first neighboring channel is labeled "Adj" (adjacent) channel; all others are labeled "Alt" (alternate) channels. You can define user-specific channel names for each channel which are displayed in the result diagram and result table.

Remote command:

[SENSe:] POWer:ACHannel:NAME:ACHannel on page 599

[SENSe:] POWer:ACHannel:NAME:ALternate<ch> on page 599

[SENSe:] POWer:ACHannel:NAME:CHANnel<ch> on page 599

8.2.3.5 How to Perform Channel Power Measurements

The following step-by-step instructions demonstrate the most common tasks when performing channel power measurements.



For remote operation, see [Chapter 9.6.3.8, "Programming Examples for Channel Power Measurements"](#), on page 611.

- [How to Perform a Standard Channel Power Measurement](#).....277
- [How to Set Up the Channels](#).....277
- [How to Manage User-Defined Configurations](#).....279
- [How to Compare the Tx Channel Power in Successive Measurements](#).....279

How to Perform a Standard Channel Power Measurement

Performing a channel power or ACLR measurement according to common standards is a very easy and straightforward task with the R&S FPL1000.

1. Press the [MEAS] key or select "Select Measurement" in the "Overview" .
2. Select "Channel Power ACLR" .
The measurement is started immediately with the default settings.
3. Select the "CP / ACLR Standard" softkey.
4. Select a standard from the list.
The measurement is restarted with the predefined settings for the selected standard.
5. If necessary, edit the settings for your specific measurement as described in ["How to Set Up the Channels"](#) on page 277, or load a user-defined configuration (see ["To load a user-defined configuration"](#) on page 279).

How to Set Up the Channels

Channel definition is the basis for measuring power levels in certain frequency ranges. Usually, the power levels in one or more carrier (Tx) channels and possibly the adjacent channels are of interest. Up to 18 carrier channels and up to 12 adjacent channels can be defined.

When a measurement standard is selected, all settings including the channel bandwidths and channel spacings are set according to the selected standard. Select a standard in the "Ch Power" menu or the "ACLR Setup" dialog box. You can adjust the settings afterwards.

Channel setup consists of the following settings:

- The number of transmission (Tx) and adjacent channels
- The bandwidth of each channel
- For multicarrier ACLR measurements: which Tx channel is used as a reference
- The spacing between the individual channels
- Optionally: the names of the channels displayed in the diagram and result table
- Optionally: the influence of individual channels on the total measurement result ("Weighting Filter")
- Optionally: limits for a limit check on the measured power levels



Changes to an existing standard can be stored as a user-defined standard, see ["How to Manage User-Defined Configurations"](#) on page 279.

- ▶ To configure the channels in the "Ch Power" dialog box, select "Ch Power" > "CP / ACLR Config" > "Channel Settings" tab.



In the "Channel Setup" dialog box, you can define the channel settings for all channels, independent of the defined number of *used* Tx or adjacent channels.

To define channel spacings

Channel spacings are normally defined by the selected standard but can be changed.

- ▶ In the "Channel Settings" tab of the "ACLR Setup" dialog box, select the "Spacing" subtab.
The value entered for any Tx channel is automatically also defined for all subsequent Tx channels. Thus, only enter one value if all Tx channels have the same spacing.
If the channel spacing for the adjacent or an alternate channel is changed, all higher alternate channel spacings are multiplied by the same factor (new spacing value/old spacing value). The lower adjacent-channel spacings remain unchanged.
Only enter one value for equal channel spacing.

Example: Defining channel spacing

In the default setting, the adjacent channels have the following spacing: 20 kHz ("ADJ"), 40 kHz ("ALT1"), 60 kHz ("ALT2"), 80 kHz ("ALT3"), 100 kHz ("ALT4"), ...

Set the spacing of the first adjacent channel ("ADJ") to *40 kHz*. For all other adjacent channels, the spacing is multiplied by factor 2: 80 kHz ("ALT1"), 120 kHz ("ALT2"), 160 kHz ("ALT3"), ...

Starting from the default setting, set the spacing of the fifth adjacent channel ("ALT4") to *150 kHz*. For all higher adjacent channels, the spacing is multiplied by factor 1.5: 180 kHz ("ALT5"), 210 kHz ("ALT6"), 240 kHz ("ALT7"), ...

How to Manage User-Defined Configurations

You can define measurement configurations independently of a predefined standard and save the current ACLR configuration as a "user standard" in an XML file. You can then load the file and thus the settings again later.

User-defined standards are not supported for multicarrier ACLR measurements.



Compatibility to R&S FSP

User standards created on an analyzer of the R&S FSP family are compatible to the R&S FPL1000. User standards created on an R&S FPL1000, however, are not necessarily compatible to the analyzers of the R&S FSP family and may not work there.

To store a user-defined configuration

1. In the "Ch Power" menu, select the "CP / ACLR Config" softkey to display the "ACLR Setup" dialog box.
2. Configure the measurement as required (see also ["How to Set Up the Channels"](#) on page 277).
3. In the "General Settings" tab, select the "Manage User Standards" button to display the "Manage" dialog box.
4. Define a filename and storage location for the user standard.
By default, the XML file is stored in
`C:\ProgramData\Rohde-Schwarz\ZNL-FPL\acp_std\`. However, you can define any other storage location.
5. Select "Save" .

To load a user-defined configuration

1. In the "General Settings" tab of the "ACLR Setup" dialog box, select the "Manage User Standards" button to display the "Manage" dialog box.
2. Select the user standard file.
3. Select "Load" .

The stored settings are automatically set on the R&S FPL1000 and the measurement is restarted with the new parameters.

How to Compare the Tx Channel Power in Successive Measurements

For power measurements with only one Tx channel and no adjacent channels, you can define a fixed reference power and compare subsequent measurement results to the stored reference power.

1. Configure a measurement with only one Tx channel and no adjacent channels (see also ["How to Set Up the Channels"](#) on page 277).
2. In the "ACLR Setup" dialog box, select the "Set CP Reference" button.

The channel power currently measured on the Tx channel is stored as a fixed reference power. The reference value is displayed in the "Reference" field of the result table (in relative ACLR mode).

3. Start a new measurement.
The resulting power is indicated relative to the fixed reference power.
4. Repeat this for any number of measurements.
5. To start a new measurement without the fixed reference, temporarily define a second channel or preset the instrument.

8.2.3.6 Measurement Examples

The R&S FPL1000 has test routines for simple channel and adjacent channel power measurements. These routines give quick results without any complex or tedious setting procedures.



A programming example demonstrating an ACLR measurement in a remote environment is provided in [Chapter 9.6.3.8, "Programming Examples for Channel Power Measurements"](#), on page 611.

- [Measurement Example 2 – Measuring Adjacent Channel Power of a W-CDMA Uplink Signal](#).....280
- [Measurement Example 3 – Measuring the Intrinsic Noise of the R&S FPL1000 with the Channel Power Function](#).....282

Measurement Example 2 – Measuring Adjacent Channel Power of a W-CDMA Uplink Signal

Test setup:

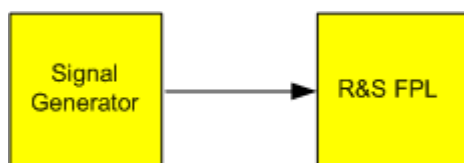

Signal generator settings (e.g. R&S SMW):

Frequency:	1950 MHz
Level:	4 dBm
Modulation:	3GPP W-CDMA Reverse Link

Procedure:

1. Preset the R&S FPL1000.

- Set the center frequency to *1950 MHz*.
- Select the "Channel Power ACLR" measurement function from the "Select Measurement" dialog box.
- Set the "W-CDMA 3GPP REV" standard for adjacent channel power measurement in the "ACLR Setup" dialog box.

The R&S FPL1000 sets the channel configuration to the W-CDMA standard for mobiles with two adjacent channels above and below the transmit channel. The frequency span, the resolution and video bandwidth and the detector are automatically set to the correct values. The spectrum is displayed in the upper window and the channel power, the level ratios of the adjacent channel powers and the channel configuration in the lower window. The individual channels are displayed as bars in the graph.

- Set the optimal reference level and RF attenuation for the applied signal level using the "Auto Level" function.

The R&S FPL1000 sets the optimum RF attenuation and the reference level for the power in the transmission channel to obtain the maximum dynamic range. The following figure shows the result of the measurement.

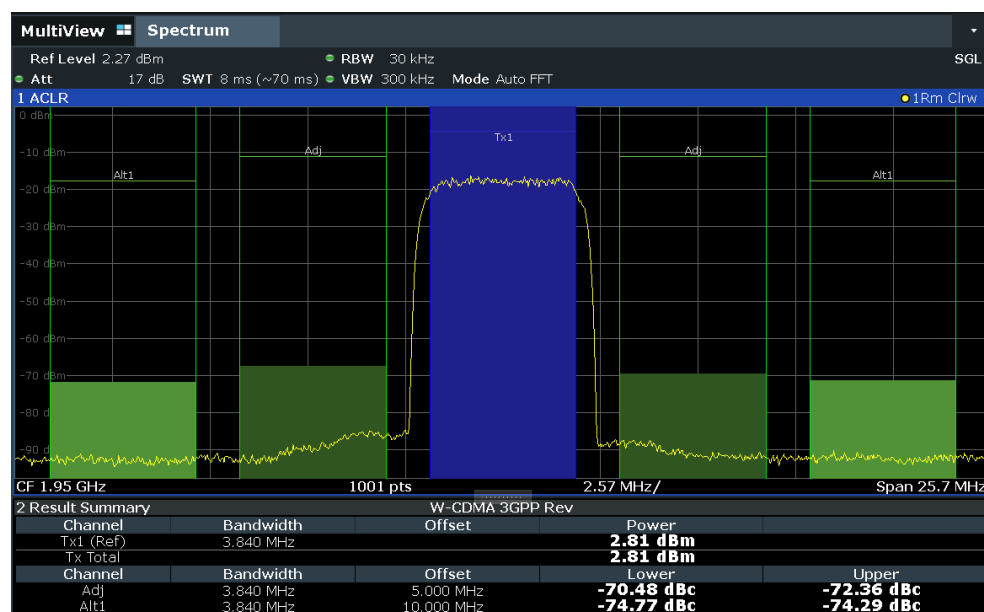

Figure 8-20: Measuring the relative adjacent channel power on a W-CDMA uplink signal

The R&S FPL1000 measures the power of the individual channels. A root raised cosine filter with the parameters $\alpha = 0.22$ and chip rate 3.84 Mcps (= receive filter for W-CDMA) is used as channel filter.

Measurement Example 3 – Measuring the Intrinsic Noise of the R&S FPL1000 with the Channel Power Function

Noise in any bandwidth can be measured with the channel power measurement functions. Thus the noise power in a communication channel can be determined, for example.

If the noise spectrum within the channel bandwidth is flat, the noise marker can be used to determine the noise power in the channel by considering the channel bandwidth. However, in the following cases, the channel power measurement method must be used to obtain correct measurement results:

- If phase noise and noise that normally increases towards the carrier is dominant in the channel to be measured
- If there are discrete spurious signals in the channel

Test setup:

- ▶ Leave the RF input of the R&S FPL1000 open-circuited or terminate it with 50 Ω .

Procedure:

1. Preset the R&S FPL1000.
2. Set the center frequency to 1 GHz and the span to 1 MHz.
3. To obtain maximum sensitivity, set RF attenuation to 0 dB and the reference level to -40 dBm.
4. Select the "Channel Power ACLR" measurement function from the "Select Measurement" dialog box.
5. In the "ACLR Setup" dialog box, set up a single Tx channel with the channel bandwidth 1.23 MHz.
6. Select the "Adjust Settings" softkey.
The settings for the frequency span, the bandwidth (RBW and VBW) and the detector are automatically set to the optimum values required for the measurement.
7. Stabilize the measurement result by increasing the "Sweep Time" .
Set the "Sweep Time" to 1 s.

The trace becomes much smoother because of the RMS detector and the channel power measurement display is much more stable.

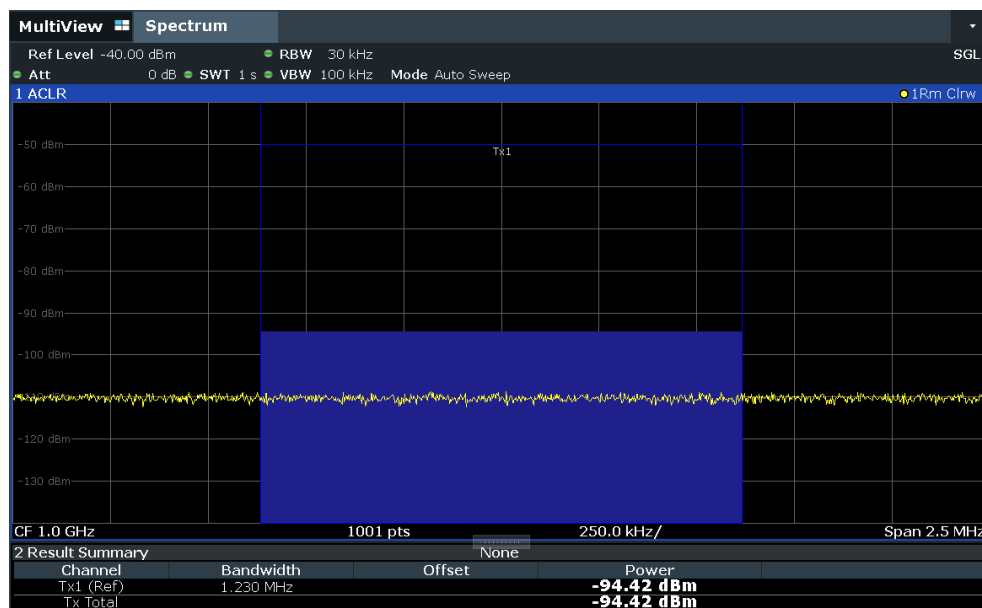

Figure 8-21: Measurement of the R&S FPL1000's intrinsic noise power in a 1.23 MHz channel bandwidth.

8.2.3.7 Optimizing and Troubleshooting the Measurement

If the results do not meet your expectations, or if you want to minimize the measurement duration, try the following methods to optimize the measurement:

- Only activate as many **adjacent channels** as necessary to minimize the required span and thus the required measurement time for the measurement.
- Increase the **RBW** to minimize the measurement time; however, consider the requirements of the standard if you need to measure according to standard! The automatic settings are always according to standard.
- Take advantage of the **speed optimization mode** in the "Sweep" settings if you do not require the larger dynamic range (see "Optimization" on page 445).
- Reduce the "**Sweep Time**" and thus the amount of data to be captured and calculated; however, consider the requirements regarding the standard deviation.
- To improve the **stability of the measured results**, increase the "Sweep Time", which also leads to more averaging steps.
- Instead of **trace averaging**, use an RMS detector with a higher "Sweep Time" to obtain better average power results in less time.
- To determine a **channel power level** quickly, use the **Time Domain Power Measurement** (TDP) rather than a Channel Power measurement. The TDP measurement is a zero span measurement where the sweep time determines the measurement time. Due to the FFT measurement, duplicate averaging is performed, providing very stable results very quickly.

Note, however, that for TDP measurements, channel filters are not available and a fixed RBW is used. Thus, the measurement may not be according to standard for some test cases.

8.2.3.8 Reference: Predefined CP/ACLR Standards

When using predefined standards for ACLR measurement, the test parameters for the channel and adjacent-channel measurements are configured automatically.

You can select a predefined standard via the "CP / ACLR Standard" softkey in the "Ch Power" menu or the selection list in the "General Settings" tab of the "ACLR Setup" dialog box (see "Standard" on page 270).

Table 8-10: Predefined CP / ACLR standards with remote command parameters

Standard	Remote parameter
None	NONE
EUTRA/LTE Square	EUTRa
EUTRA/LTE Square/RRC	REUTra
W-CDMA 3GPP FWD	FW3Gppcdma
W-CDMA 3GPP REV	RW3Gppcdma
WLAN 802.11A	AWLAN
WLAN 802.11B	BWLAN
RFID 14443	RFID14443
TETRA	TETRa

8.2.4 Carrier-to-Noise Measurements

Measures the carrier-to-noise ratio. C/No measurements normalize the ratio to a 1 Hz bandwidth.

- [About the Measurement](#).....284
- [Carrier-to-Noise Results](#).....285
- [Carrier-to-Noise Configuration](#)..... 286
- [How to Determine the Carrier-to-Noise Ratio](#)..... 288

8.2.4.1 About the Measurement

The largest signal in the frequency span is the carrier. It is searched when the C/N or C/N₀ function is activated and is marked using a fixed reference marker ("FXD").

To determine the noise power, a channel with a defined bandwidth at the defined center frequency is analyzed. The power within this channel is integrated to obtain the noise power level. (If the carrier is within this channel, an extra step is required to determine the correct noise power level, see below.)

The noise power of the channel is subtracted from the maximum carrier signal level, and in the case of a C/N₀ measurement, it is referred to a 1 Hz bandwidth.



For this measurement, the RMS detector is activated.

The carrier-to-noise measurements are only available in the frequency domain (span >0).

Measurement process

Depending on whether the carrier is inside or outside the analyzed channel, the measurement process for the carrier-to-noise ratio varies:

- The carrier is outside the analyzed channel: In this case, it is sufficient to switch on the desired measurement function and to set the channel bandwidth. The carrier/noise ratio is displayed on the screen.
- The carrier is inside the analyzed channel: In this case, the measurement must be performed in two steps:
 - First, perform the reference measurement by switching on either the C/N or the C/N_0 measurement and waiting for the end of the next measurement run. The fixed reference marker is set to the maximum of the measured carrier signal.
 - Then, switch off the carrier so that only the noise of the test setup is active in the channel. The carrier-to-noise ratio is displayed after the subsequent measurement has been completed.

Frequency Span

The frequency span should be set to approximately twice the channel bandwidth in order to measure the carrier-to-noise ratio correctly. This setting is defined automatically by the "Adjust Settings" function.

8.2.4.2 Carrier-to-Noise Results

As a result of the carrier-to-noise measurement the evaluated bandwidth and the calculated C/N ratio are displayed in the result window. The fixed reference marker is indicated in the diagram.

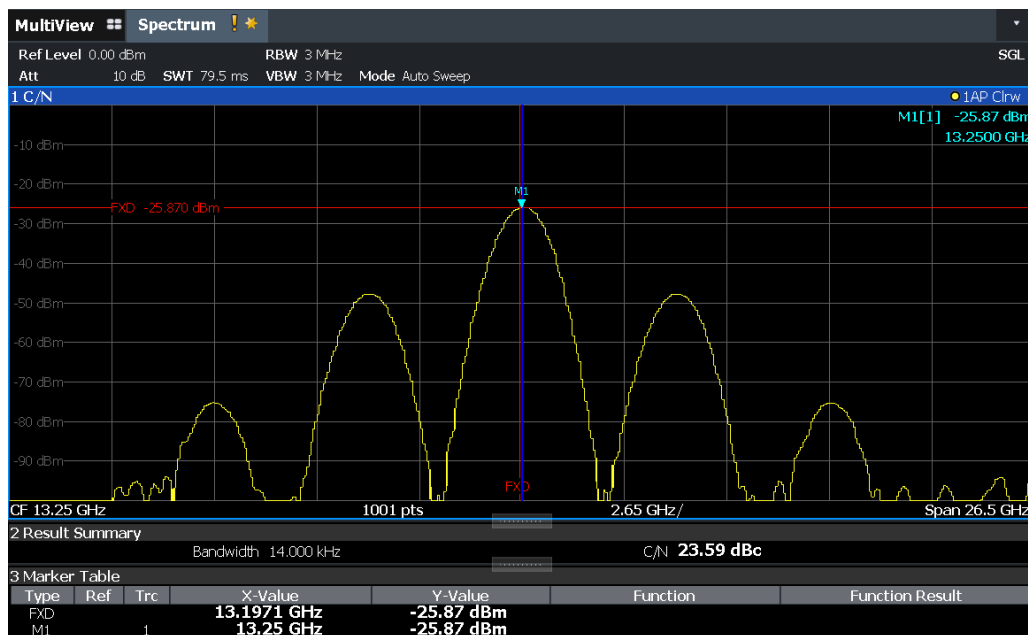

Remote command:

You can also query the determined carrier-to-noise ratio via the remote command `CALC:MARK:FUNC:POW:RES? CN` or `CALC:MARK:FUNC:POW:RES? CN0`, see [CALCulate<n>:MARKer<m>:FUNCTION:POWer<sb>:RESult?](#) on page 592.

8.2.4.3 Carrier-to-Noise Configuration

Access: "Overview" > "Select Measurement" > "C/N" / "C/N0" > "Carrier Noise Config"

Both a carrier-to-noise ratio (C/N) and a carrier-to-noise ratio in relation to the bandwidth (C/N₀) measurement are available.

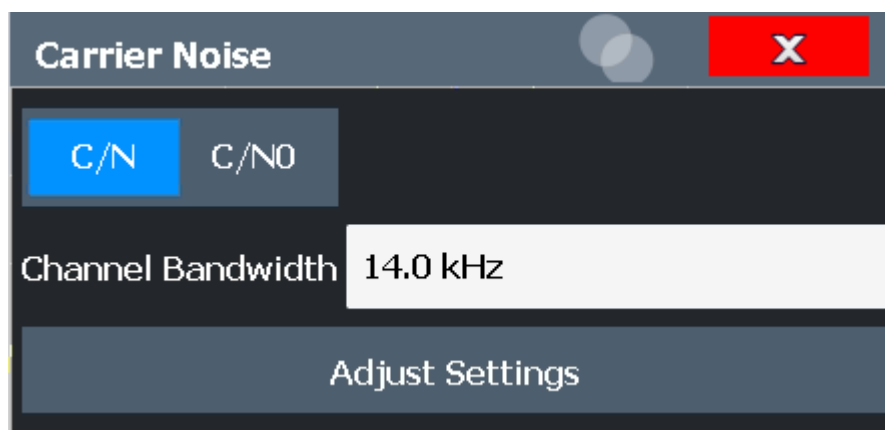

Carrier-to-noise measurements are not available in zero span mode.



The easiest way to configure a measurement is using the configuration "Overview", see [Chapter 8.1, "Configuration Overview"](#), on page 237.

The remote commands required to perform these tasks are described in [Chapter 9.6.4, "Measuring the Carrier-to-Noise Ratio"](#), on page 613.

C/N	287
C/NO	287
Channel Bandwidth	287
Adjust Settings	287

C/N

Switches the measurement of the carrier/noise ratio on or off. If no marker is active, marker 1 is activated.

The measurement is performed on the trace that marker 1 is assigned to. To shift marker 1 and measure another trace, use the "Marker To Trace" softkey in the "Marker" menu (see ["Assigning the Marker to a Trace"](#) on page 398).

Remote command:

[CALCulate<n>:MARKer<m>:FUNCTION:POWER<sb>:SElect](#) on page 593

[CALCulate<n>:MARKer<m>:FUNCTION:POWER<sb>:RESult?](#) on page 592

[CALCulate<n>:MARKer<m>:FUNCTION:POWER<sb>\[:STATE\]](#) on page 594

C/NO

Switches the measurement of the carrier/noise ratio with reference to a 1 Hz bandwidth on or off. If no marker is active, marker 1 is activated.

The measurement is performed on the trace that marker 1 is assigned to. To shift marker 1 and measure another trace, use the "Marker To Trace" softkey in the "Marker" menu (see ["Assigning the Marker to a Trace"](#) on page 398).

Remote command:

[CALCulate<n>:MARKer<m>:FUNCTION:POWER<sb>:SElect](#) on page 593

[CALCulate<n>:MARKer<m>:FUNCTION:POWER<sb>:RESult?](#) on page 592

[CALCulate<n>:MARKer<m>:FUNCTION:POWER<sb>\[:STATE\]](#) on page 594

Channel Bandwidth

Defines the channel bandwidth.

The default setting is 14 kHz.

Remote command:

[\[SENSe:\] POWER:ACHannel:BANDwidth\[:CHANnel<ch>\]](#) on page 598

Adjust Settings

Enables the RMS detector and adjusts the span to the selected channel bandwidth according to:

"4 x channel bandwidth + measurement margin"

The adjustment is performed once; if necessary, the setting can be changed later on.

Remote command:

[\[SENSe:\] POWER:ACHannel:PRESet](#) on page 594

8.2.4.4 How to Determine the Carrier-to-Noise Ratio

The following step-by-step instructions demonstrate how to determine the carrier-to-noise ratio.



For remote operation, see ["Programming example: Measuring the carrier-to-noise ratio"](#) on page 613.

1. Press the "C/N" , "C/N0" softkey to configure the carrier-to-noise ratio measurement.
2. To change the channel bandwidth to be analyzed, press the "Channel Bandwidth" softkey.
3. To optimize the settings for the selected channel configuration, press the "Adjust Settings" softkey.
4. To activate the measurements without reference to the bandwidth, press the "C/N" softkey.
To activate the measurements with reference to the bandwidth, press the "C/N₀" softkey .
5. If the carrier signal is located within the analyzed channel bandwidth, switch off the carrier signal so that only the noise is displayed in the channel and perform a second measurement.

The carrier-to-noise ratio is displayed after the measurement has been completed.

8.2.5 Occupied Bandwidth Measurement (OBW)

An important characteristic of a modulated signal is its occupied bandwidth, that is: the bandwidth which must contain a defined percentage of the power. In a radio communications system, for instance, the occupied bandwidth must be limited to enable distortion-free transmission in adjacent channels.

- [About the Measurement](#).....288
- [OBW Results](#).....290
- [OBW Configuration](#)..... 291
- [How to Determine the Occupied Bandwidth](#)..... 293
- [Measurement Example](#)..... 294

8.2.5.1 About the Measurement

The occupied bandwidth is defined as the bandwidth containing a defined percentage of the total transmitted power. A percentage between 10 % and 99.9 % can be set.

Measurement principle

The bandwidth containing 99% of the signal power is to be determined, for example. The algorithm first calculates the total power of all displayed points of the trace. In the

next step, the points from the right edge of the trace are summed up until 0.5 % of the total power is reached. Auxiliary marker 1 is positioned at the corresponding frequency. Then the points from the left edge of the trace are summed up until 0.5 % of the power is reached. Auxiliary marker 2 is positioned at this point. 99 % of the power is now between the two markers. The distance between the two frequency markers is the occupied bandwidth which is displayed in the marker field.



OBW within defined search limits - multicarrier OBW measurement in one sweep

The occupied bandwidth of the signal can also be determined within defined search limits instead of for the entire signal. Thus, only a single sweep is required to determine the OBW for a multicarrier signal. To do so, search limits are defined for an individual carrier and the OBW measurement is restricted to the frequency range contained within those limits. Then the search limits are adapted for the next carrier and the OBW is automatically recalculated for the new range.

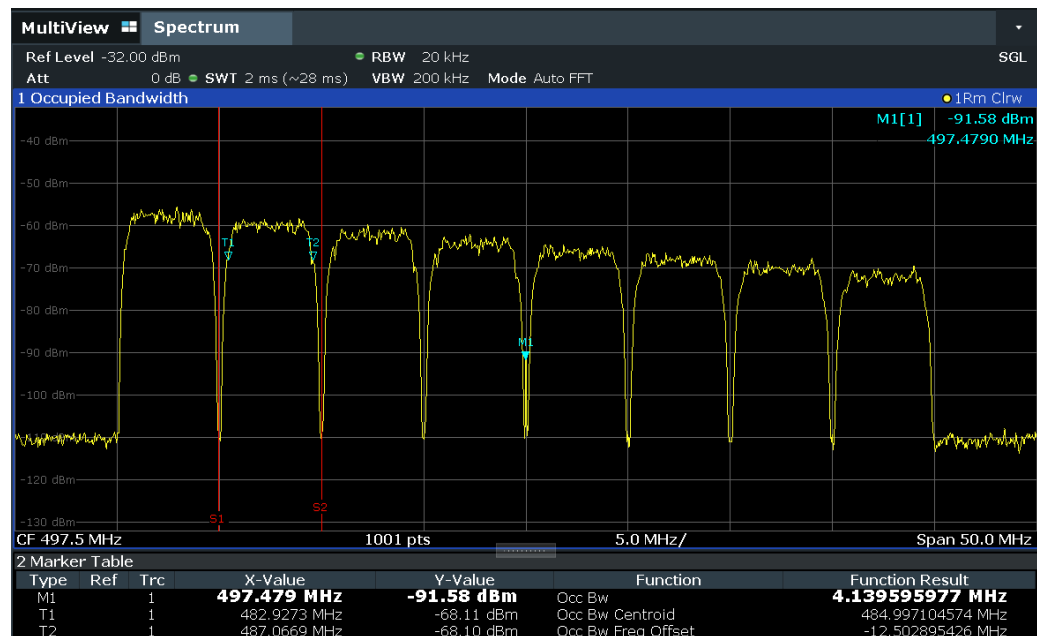

For step-by-step instructions, see ["How to determine the OBW for a multicarrier signal using search limits"](#) on page 293.

Prerequisites

To ensure correct power measurement, especially for noise signals, and to obtain the correct occupied bandwidth, the following prerequisites and settings are necessary:

- Only the signal to be measured is displayed in the window, or search limits are defined to include only one (carrier) signal. An additional signal would falsify the measurement.
- $RBW \ll$ occupied bandwidth (approx. 1/20 of occupied bandwidth, for voice communication type: 300 Hz or 1 kHz)
- $VBW \geq 3 \times RBW$
- RMS detector

- Span ≥ 2 to 3 x occupied bandwidth

Some of the measurement specifications (e.g. PDC, RCR STD-27B) require measurement of the occupied bandwidth using a peak detector. The detector setting of the R&S FPL1000 has to be changed accordingly then.

8.2.5.2 OBW Results

As a result of the OBW measurement the occupied bandwidth ("Occ Bw") is indicated in the marker results. Furthermore, the marker at the center frequency and the temporary markers are indicated.

The measurement is performed on the trace with marker 1. In order to evaluate another trace, marker 1 must be placed on another trace (see [Assigning the Marker to a Trace](#)).



The OBW calculation is repeated if the [Search Limits](#) are changed, without performing a new sweep. Thus, the OBW for a multicarrier signal can be determined using only one sweep.

Centroid frequency

The centroid frequency is defined as the point in the center of the occupied bandwidth, calculated using the temporary OBW markers T1 and T2. This frequency is indicated as a function result ("Occ Bw Centroid") in the marker table.

Frequency offset

The offset of the calculated centroid frequency to the defined center frequency of the R&S FPL1000 is indicated as a function result ("Occ Bw Freq Offset") in the marker table.

Remote command:

The determined occupied bandwidth can also be queried using the remote command `CALC:MARK:FUNC:POW:RES? OBW` or `CALC:MARK:FUNC:POW:RES? AOBW`. While the `OBW` parameter returns only the occupied bandwidth, the `AOBW` parameter also returns the position and level of the temporary markers T1 and T2 used to calculate the occupied bandwidth.

`CALC:MARK:FUNC:POW:SEL OBW`, see [CALCulate<n>:MARKer<m>:FUNCTION:POWer<sb>:SElect](#) on page 593

[CALCulate<n>:MARKer<m>:FUNCTION:POWer<sb>\[:STATe\]](#) on page 594

`CALC:MARK:FUNC:POW:RES? OBW`, see [CALCulate<n>:MARKer<m>:FUNCTION:POWer<sb>:RESult?](#) on page 592

`CALC:MARK:FUNC:POW:RES? COBW`, see [CALCulate<n>:MARKer<m>:FUNCTION:POWer<sb>:RESult?](#) on page 592

8.2.5.3 OBW Configuration

Access: "Overview" > "Select Measurement" > "OBW" > "OBW Config"

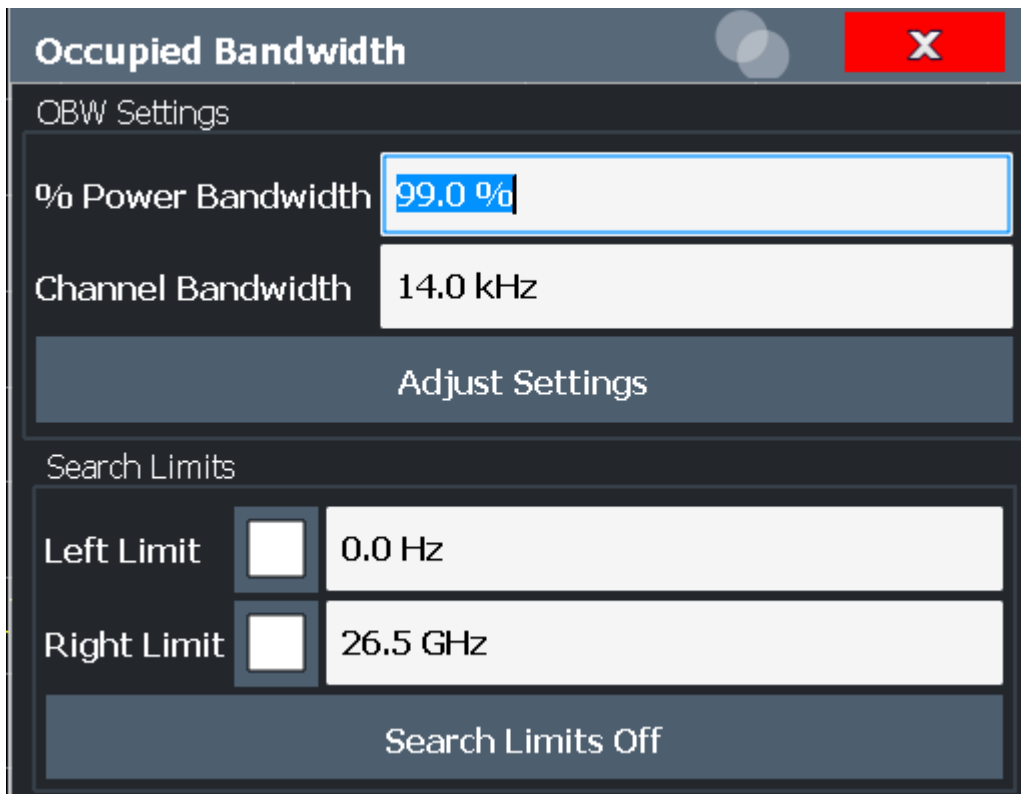

This measurement is not available in zero span.



Configuring search limits for OBW measurement

The OBW measurement uses the same search limits as defined for marker search (see " [Search Limits](#) " on page 474). However, only the left and right limits are considered.

The remote commands required to perform these tasks are described in [Chapter 9.6.5, "Measuring the Occupied Bandwidth"](#), on page 614.

% Power Bandwidth	291
Channel Bandwidth	292
Adjust Settings	292
Search Limits (Left / Right)	292
Deactivating All Search Limits	292

% Power Bandwidth

Defines the percentage of total power in the displayed frequency range which defines the occupied bandwidth. Values from 10 % to 99.9 % are allowed.

Remote command:

`[SENSe:]POWer:BANDwidth` on page 614

Channel Bandwidth

Defines the channel bandwidth for the transmission channel in single-carrier measurements. This bandwidth is used to optimize the test parameters (for details see "[Adjust Settings](#)" on page 292). The default setting is 14 kHz.

For measurements according to a specific transmission standard, define the bandwidth specified by the standard for the transmission channel.

For multicarrier measurements, this setting is irrelevant.

Remote command:

`[SENSe:]POWer:ACHannel:BANDwidth[:CHANnel<ch>]` on page 598

Adjust Settings

Optimizes the instrument settings for the measurement of the occupied bandwidth according to the specified channel bandwidth.

This function is only useful for single carrier measurements.

All instrument settings relevant for power measurement within a specific frequency range are optimized:

- Frequency span: $3 \times$ channel bandwidth
- RBW \leq 1/40 of channel bandwidth
- VBW \geq $3 \times$ RBW
- Detector: RMS

The reference level is not affected by "Adjust Settings". For an optimum dynamic range, select the reference level such that the signal maximum is close to the reference level.

(See "[Setting the Reference Level Automatically \(Auto Level \)](#)" on page 431).

The adjustment is carried out only once. If necessary, the instrument settings can be changed later.

Remote command:

`[SENSe:]POWer:ACHannel:PRESet` on page 594

Search Limits (Left / Right)

If activated, limit lines are defined and displayed for the search. Only results within the limited search range are considered.

For details on limit lines for searches, see "[Peak search limits](#)" on page 496.

Remote command:

`CALCulate<n>:MARKer<m>:X:SLIMits[:STATe]` on page 793

`CALCulate<n>:MARKer<m>:X:SLIMits:LEFT` on page 793

`CALCulate<n>:MARKer<m>:X:SLIMits:RIGHT` on page 794

Deactivating All Search Limits

Deactivates the search range limits.

Remote command:

`CALCulate<n>:MARKer<m>:X:SLIMits[:STATe]` on page 793

`CALCulate<n>:THReshold:STATe` on page 795

8.2.5.4 How to Determine the Occupied Bandwidth

The following step-by-step instructions demonstrate how to determine the occupied bandwidth.



For remote operation, see [Chapter 9.6.5.2, "Programming Example: OBW Measurement"](#), on page 615.

How to determine the OBW for a single signal

1. Press the [MEAS] key or select "Select Measurement" in the "Overview" .
2. Select the "OBW" measurement function.
The measurement is started immediately with the default settings.
3. Select the "OBW Config" softkey.
The "Occupied Bandwidth" configuration dialog box is displayed.
4. Define the percentage of power ("% Power Bandwidth") that defines the bandwidth to be determined.
5. If necessary, change the channel bandwidth for the transmission channel.
6. To optimize the settings for the selected channel configuration, select "Adjust Settings" .
7. Start a sweep.
The result is displayed as OBW in the marker results.

How to determine the OBW for a multicarrier signal using search limits

1. Press the [MEAS] key or select "Select Measurement" in the "Overview" .
2. Select the "OBW" measurement function.
3. Select the "OBW Config" softkey.
4. Define the percentage of power ("% Power Bandwidth") that defines the bandwidth to be determined.
5. Define search limits so the search area contains only the first carrier signal:
 - a) Enter values for the left or right limits, or both.
 - b) Enable the use of the required limits.
6. Start a sweep.
The result for the first carrier is displayed as OBW in the marker results.
7. Change the search limits so the search area contains the next carrier signal as described in [step 5](#).
The OBW is recalculated and the result for the next carrier is displayed. A new sweep is not necessary!

8. Continue in this way until all carriers have been measured.

8.2.5.5 Measurement Example

In the following example, the bandwidth that occupies 99 % of the total power of a PDC signal at 800 MHz, level 0 dBm is measured.



A programming example demonstrating an OBW measurement in a remote environment is provided in [Chapter 9.6.5.2, "Programming Example: OBW Measurement"](#), on page 615.

1. Preset the R&S FPL1000.
2. Set the "Center Frequency" to *800 MHz*.
3. Set the "Reference Level" to *-10 dBm*.
4. Press the [MEAS] key or select "Select Measurement" in the "Overview" .
5. Select the "OBW" measurement function.
6. Select the "OBW Config" softkey.
7. Set the "% Power Bandwidth" to *99 %*.
8. Set the "Channel Bandwidth" to *21 kHz* as specified by the PDC standard.
9. Optimize the settings for the selected channel configuration by selecting "Adjust Settings" .
10. Adjust the reference level to the measured total power by selecting "Auto Level" in the [Auto set] menu.
11. The PDC standard requires the peak detector for OBW measurement. In the "Traces" configuration dialog, set the trace detector to "PositivePeak" .
12. Start a sweep.

The result is displayed as OBW in the marker results.

8.2.6 Spectrum Emission Mask (SEM) Measurement

Spectrum Emission Mask (SEM) measurements monitor compliance with a spectral mask.

- [About the Measurement](#).....295
- [Typical Applications](#).....295
- [SEM Results](#)..... 295
- [SEM Basics](#).....298
- [SEM Configuration](#).....308
- [How to Perform a Spectrum Emission Mask Measurement](#).....322
- [Measurement Example: Multi-SEM Measurement](#).....326
- [Reference: SEM File Descriptions](#)..... 328

8.2.6.1 About the Measurement

The Spectrum Emission Mask (SEM) measurement defines a measurement that monitors compliance with a spectral mask. The mask is defined with reference to the input signal power. The R&S FPL1000 allows for a flexible definition of all parameters in the SEM measurement. The analyzer performs measurements in predefined frequency ranges with settings that can be specified individually for each of these ranges.

In the basic Spectrum application, spectrum emissions can be measured for multiple sub blocks of channels, where the sub blocks can include gaps or overlap, and define separate masks. Radio signals using multiple standards can also be analyzed.

SEM measurement configurations can be saved to an XML file which can then be exported to another application or loaded on the R&S FPL1000 again later. Some predefined XML files are provided that contain ranges and parameters according to the selected standard.

To improve the performance of the R&S FPL1000 for spectrum emission mask measurements, a "Fast SEM" mode is available.

A special limit check for SEM measurements allows for monitoring compliance of the spectrum.

8.2.6.2 Typical Applications

Spectrum Emission Mask measurements are typically performed to ensure that modulated signals remain within the valid signal level ranges. These ranges are defined by a particular transmission standard, both in the transmission channel and neighboring channels. Any violations of the mask can interfere with other transmissions.

The 3GPP TS 34.122 standard, for example, defines a mask for emissions outside the transmission channel. This mask is defined relative to the input signal power. Three frequency ranges to each side of the transmission channel are defined.

8.2.6.3 SEM Results

As a result of the Spectrum Emission Mask measurement, the following results are displayed in a diagram (see also "[Limit Lines in SEM Measurements](#)" on page 301):

- The measured signal levels
- The result of the limit check (mask monitoring)
- The defined limit lines
- TX channel power "P"
- The used power class



Multi-SEM measurements

Multi-SEM measurements are SEM measurements with more than one sub block. In these measurements, each sub block has its own power class definitions. In this case, the power class is not indicated in the graphical result displays.

Example:

For example, in [Figure 8-22](#), "31 < P < 39" is indicated as the used power class is defined from 31 to 39.

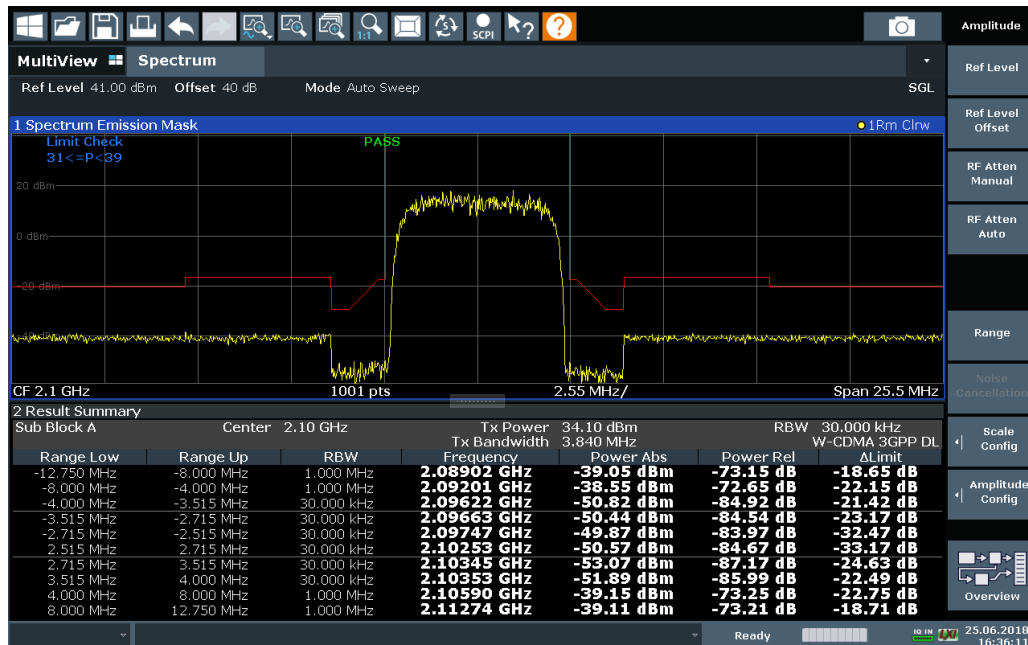

Figure 8-22: Spectrum Emission Mask result displays

In addition to the graphical results of the SEM measurement displayed in the diagram, a result summary is displayed to evaluate the limit check results (see also "[Limit Lines in SEM Measurements](#)" on page 301).

The following information is provided in the result summary:

Label	Description
General information	
"Standard"	Loaded standard settings
"Tx Power"	Power of the reference range
"Tx Bandwidth"	Tx bandwidth used by the reference range
"RBW"	RBW used by the reference range
Range results	
"Range Low"	Start of the frequency range the peak value was found in
"Range Up"	Frequency range end the peak value was found in
"RBW"	RBW of the range
"Frequency"	Frequency of the peak power level
"Power Abs"	Absolute peak power level within the range

Label	Description
"Power Rel"	Peak power level within the range, relative to the "Tx Power"
"ΔLimit"	Deviation of the peak power level from the limit line

You can define in which detail the data is displayed in the result summary in the "List Evaluation" settings (see "[List Evaluation \(Results Configuration\)](#)" on page 320). By default, one peak per range is displayed. However, you can change the settings to display only peaks that exceed a threshold ("Margin").

Detected peaks are not only listed in the Result Summary, they are also indicated by colored squares in the diagram (optionally, see [Show Peaks](#) in the "List Evaluation" settings).



Figure 8-23: Detected peak display in SEM measurement

Furthermore, you can export the results of the result summary to a file which can be exported to another application for further analysis.

Results for SEM with multiple sub blocks

In the Spectrum application only, spectrum emissions can be measured for multiple sub blocks of channels (see "[SEM with Multiple Sub Blocks \("Multi-SEM"\)](#)" on page 304 for details). Up to three sub blocks (with two gaps) can be defined. For each sub block and each gap, the results described above are provided individually in the result summary.

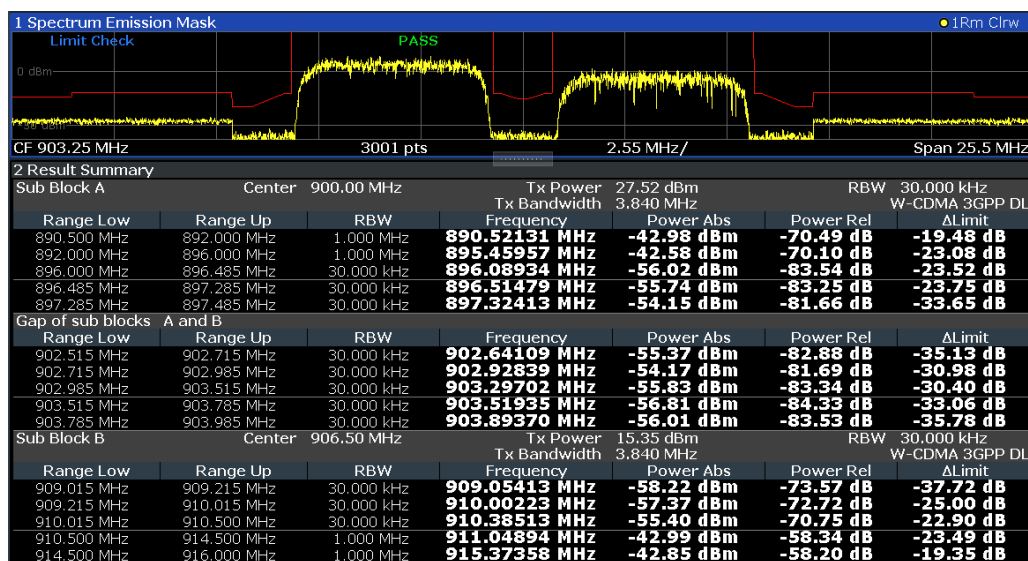

Figure 8-24: SEM results for multiple sub blocks

Retrieving results via remote control

The measurement results of the spectrum emission mask test can be retrieved using the `CALC:LIM:FAIL?` command from a remote computer; see `CALCulate<n>:LIMit:FAIL?` on page 858 for a detailed description.

The power result for the reference range can be queried using `CALC:MARK:FUNC:POW:RES? CPOW`;

The peak power for the reference range can be queried using `CALC:MARK:FUNC:POW:RES? PPOW`, see `CALCulate<n>:MARKer<m>:FUNCTION:POWer<sb>:RESult?` on page 592.

The measured power trace can be queried using `TRAC:DATA?` and `TRAC:DATA:X?`, see `TRACe<n>[:DATA]` on page 776 and `TRACe<n>[:DATA]:X?` on page 778:

The measured peak power list can be queried using `TRAC:DATA? LIST`, see `TRACe<n>[:DATA]` on page 776.

8.2.6.4 SEM Basics

Some background knowledge on basic terms and principles used in SEM measurements is provided here for a better understanding of the required configuration settings.

- [Ranges and Range Settings](#)..... 299
- [Limit Lines in SEM Measurements](#)..... 301
- [Fast SEM Measurements](#)..... 303
- [SEM with Multiple Sub Blocks \("Multi-SEM"\)](#)..... 304

Ranges and Range Settings

In the Spectrum Emission Mask measurements, a range defines a segment for which you can define the following parameters separately:

- Start and stop frequency
- RBW
- VBW
- "Sweep Time"
- "Sweep Points"
- Reference level
- Attenuator settings
- Preamplifier settings
- Transducer settings
- Limit values

Via the sweep list, you define the ranges and their settings. For details on settings, refer to "[Sweep List](#)" on page 309.

For details on defining the limits (masks), see "[Limit Lines in SEM Measurements](#)" on page 301.

Range definition

After a preset, the sweep list contains a set of default ranges and parameters. For each range, you can change the parameters listed above. You can insert or delete ranges.

The changes of the sweep list are only kept until you load another parameter set (by pressing [PRESET] or by loading an XML file). If you want a parameter set to be available permanently, create an XML file for this configuration (for details refer to "[How to save a user-defined SEM settings file](#)" on page 325).

If you load one of the provided XML files, the sweep list contains ranges and parameters according to the selected standard.

Reference range

The range containing the center frequency is defined as the reference range for all other ranges in the sweep list. All range limits are defined in relation to the reference range. The TX power used as a reference for all power level results in the result summary is also calculated for this reference range. You can define whether the power used for reference is the peak power level or the integrated power of the reference range. In the "Sweep List", the reference range is highlighted in blue and cannot be deleted.

Rules

The following rules apply to ranges:

- The minimum span of a range is 20 Hz.
- The individual ranges must not overlap (but can have gaps).

- The maximum number of ranges is 30.
- The minimum number of ranges is 3.
- The reference range cannot be deleted.
- Center the reference range on the center frequency.
- The current "Tx Bandwidth" defines the minimum span of the reference range (see "[Channel Power Settings](#)" on page 316).
- Define frequency values for each range relative to the center frequency.

To change the start frequency of the first range or the stop frequency of the last range, select the appropriate span with the [SPAN] key. You can define a span that is smaller than the combined span of all ranges. In this case, the measurement includes only the ranges that lie within the defined span and have a minimum span of 20 Hz. The first and last ranges are adapted to the given span as long as the minimum span of 20 Hz is not violated.

Sweep points

You can define a minimum number of sweep points for each range. The total number of available sweep points is then distributed among the ranges in consideration of the minimum values. If the total number of sweep points is not enough to satisfy the minimum sweep point requirements in all ranges, the R&S FPL1000 adjusts the global number of [Sweep Points](#) accordingly. By default, each range has a minimum of one sweep point.

This allows you to increase the resolution within a specific range for detailed analysis. You do not have to increase the overall number of sweep points and thus the measurement time for the SEM measurement.

Symmetrical ranges

You can easily define a sweep list with symmetrical range settings, i.e. the ranges to the left and right of the reference range are defined symmetrically. When symmetrical setup is activated, the current sweep list configuration is changed to define a symmetrical setup regarding the reference range. The number of ranges to the left of the reference range is reflected to the right, i.e. any missing ranges on the right are inserted, while superfluous ranges are removed. The values in the ranges to the right of the reference range are adapted symmetrically to those in the left ranges.

Symmetrical ranges fulfill the conditions required for "Fast SEM" mode (see "[Fast SEM Measurements](#)" on page 303).

Power classes

If the signal power level to be monitored varies and the limits vary accordingly, you can define power classes, which can then be assigned to the frequency ranges. Thus, the limits for the signal levels can be defined differently for varying input levels. For instance, for higher input levels a transmission standard can allow for higher power levels in adjacent channels, whereas for lower input levels the allowed deviation can be stricter. Up to four different power classes can be defined.

Limit Lines in SEM Measurements

For the R&S FPL1000, the spectrum emission mask is defined using limit lines. Limit lines allow you to check the measured data (that is, the trace results) against specified limit values. Generally, it is possible to define limit lines for any measurement in the Spectrum application application using the [Lines] function. For SEM measurements, however, special limit lines are available via the "Sweep List" , and it is strongly recommended that you use only these limit line definitions.

In the "Sweep List" , you can define a limit line for each power class that varies its level according to the specified frequency ranges. Special limit lines are automatically defined for each power class according to the current "Sweep List" settings every time the settings change. These limit lines are labeled "_SEM_LINE_<xxx>_ABS<0...3>" and "_SEM_LINE_<xxx>_REL<0...3>" , where <xxx> is an index to distinguish limit lines between different channel setups.

The limit line defined for the currently used power class is indicated by a red line in the display. The result of the limit check is indicated at the top of the diagram. Note that only "Pass" or "Fail" is indicated; a "Margin" function as for general limit lines is not available.

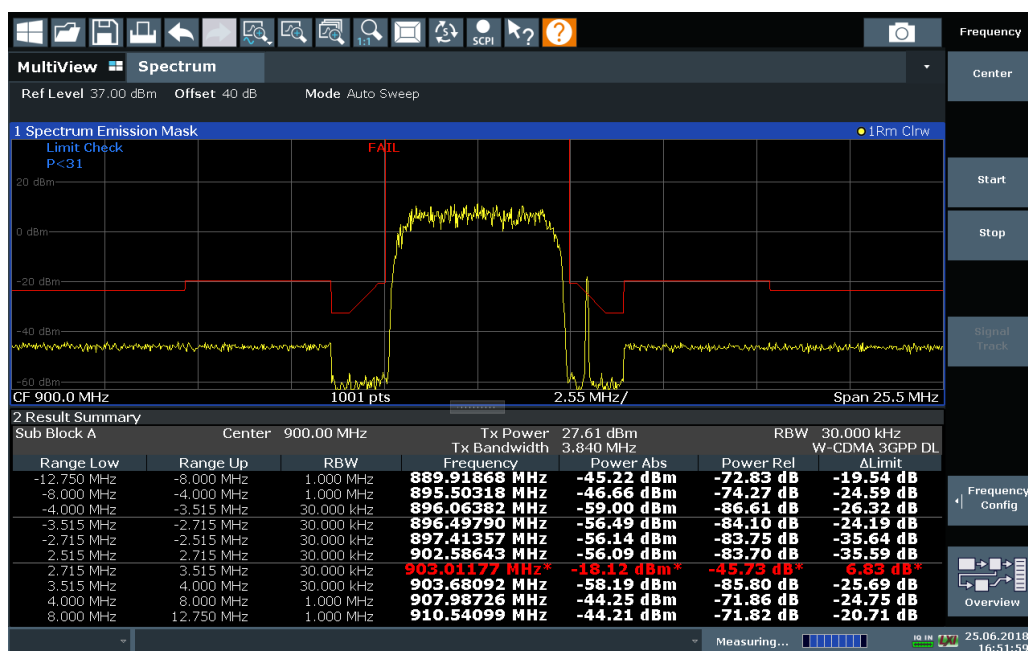

The indicated limit line depends on the settings in the "Sweep List" . Several types of limit checks are possible:

Table 8-11: Limit check types

Limit check type	Pass/fail criteria	Limit line definition
"Absolute"	Absolute power levels must not exceed limit line	Defined by the "Abs Limit Start" / "Abs Limit Stop" values for each range
"Relative"	Power deviations relative to the TX channel power must not exceed limit line	Defined by the "Rel Limit Start" / "Rel Limit Stop" values (relative to the TX channel power), fixed for each range.

Limit check type	Pass/fail criteria	Limit line definition
"Relative with function f(x)"	If the power exceeds both the absolute and the relative limits, the check fails (see Relative limit line functions below)	Defined by the maximum of the absolute or relative start and stop limit values for each range. Thus, the start or stop point of the limit range, or both, are variable (since the maximum can vary).
"Abs and Rel"	If the power exceeds both the absolute and the relative limits, the check fails.	The less strict (higher) limit line is displayed for each range. If you use a function to define the relative limit start or stop value, the signal is checked against an additional condition: the power must exceed the absolute limit, as well as the absolute and relative function values.
"Abs or Rel"	If the power exceeds either the absolute or the relative limits, the check fails.	The stricter (lower) limit line is displayed for each range. If you use a function to define the relative limit start or stop value, the signal is checked against an additional condition: if the power exceeds the absolute limit, or the higher of the absolute and relative function values, the check fails.

Relative limit line functions

A new function allows you to define limit lines whose start or end points (or both) are variable, depending on the carrier power. Thus, the resulting limit line can change its slope within the range, depending on the carrier power. Common relative limit lines are calculated once for the defined start and end points and maintain a constant slope.

If the relative limit value function is used in combination with the "Abs and Rel" or "Abs or Rel" limit check types, an additional condition is considered for the limit check (see [Table 8-11](#)).

Limit check results in the result summary

For each range, the peak measured value and the deviation of these values from the limit line are displayed in the result summary. If the limit check is passed for the range, the deviation represents the closest value to the limit line. If the limit check is passed for the range, the deviation represents the closest value to the limit line. If the limit check for the range fails, the deviation represents the maximum violation against the limit line. Furthermore, the absolute power levels and the relative deviation of the peaks from the TX channel power are displayed. Values that exceed the limit are indicated in red and by an asterisk (*).

A2 Spectrum Emission Mask				W-CDMA 3GPP (31,39)dBm DL		
Tx Power -28.10 dBm		Tx Bandwidth 3.840 MHz		RBW 1.000 MHz		
Range Low	Range Up	RBW	Frequency	Power Abs	Power Rel	ΔLimit
-12.750 MHz	-8.000 MHz	1.000 MHz	13.24173 GHz*	-47.08 dBm*	-18.98 dB*	35.52 dB*
-8.000 MHz	-4.000 MHz	1.000 MHz	13.24364 GHz*	-25.01 dBm*	3.09 dB*	53.59 dB*
-4.000 MHz	-3.515 MHz	30.000 kHz	13.24619 GHz	-100.18 dBm	-72.08 dB	-8.58 dB
-3.515 MHz	-2.715 MHz	30.000 kHz	13.24668 GHz	-105.92 dBm	-77.83 dB	-17.23 dB



Although a margin functionality is not available for the limit check, a margin (threshold) for the peak values to be displayed in the Result Summary can be defined. (In the "List Evaluation" settings, see "[List Evaluation \(Results Configuration\)](#)" on page 320).

Fast SEM Measurements

To improve the performance of the R&S FPL1000 for spectrum emission mask measurements, a "Fast SEM" mode is available. If this mode is activated, several consecutive ranges with identical sweep settings are combined to one sweep internally, which makes the measurement considerably faster. The displayed results remain unchanged and still consist of several ranges. Thus, measurement settings that apply only to the results, such as limits, can nevertheless be defined individually for each range.

Prerequisites

"Fast SEM" mode is available if the following criteria apply:

- The frequency ranges are consecutive, without frequency gaps
- The following sweep settings are identical (for details see "[Sweep List](#)" on page 309):
 - "Filter Type"
 - "RBW"
 - "VBW"
 - "Sweep Time Mode"
 - "Reference Level"
 - "RF Attenuation Mode"
 - "RF Attenuation"
 - "Preamplifier"

Activating Fast SEM mode

"Fast SEM" mode is activated in the sweep list (see "[Sweep List](#)" on page 309) or using a remote command. Activating the mode for one range automatically activates it for all ranges in the sweep list.

Remote command:

[SENSe:]ESpectrum<sb>:HSPEED on page 620



Fast SEM not supported for multiple sub blocks

For SEM with multiple sub blocks, fast SEM is not available. If more than one sub block is defined and a standard is loaded which contains an active fast SEM setting, this setting is disabled.

For more information on multi-SEM measurements, see "[SEM with Multiple Sub Blocks \("Multi-SEM"\)](#)" on page 304.

Consequences

When the "Fast SEM" mode is activated, the ranges for which these criteria apply are displayed as one single range. The sweep time is defined as the sum of the individual sweep times, initially, but can be changed.



If "Symmetrical Setup" mode is active when "Fast SEM" mode is activated, not all sweep list settings can be configured symmetrically automatically (see also "Symmetrical Setup" on page 314).

Any other changes to the sweep settings of the combined range are applied to each included range and remain changed even after deactivating "Fast SEM" mode.

Example

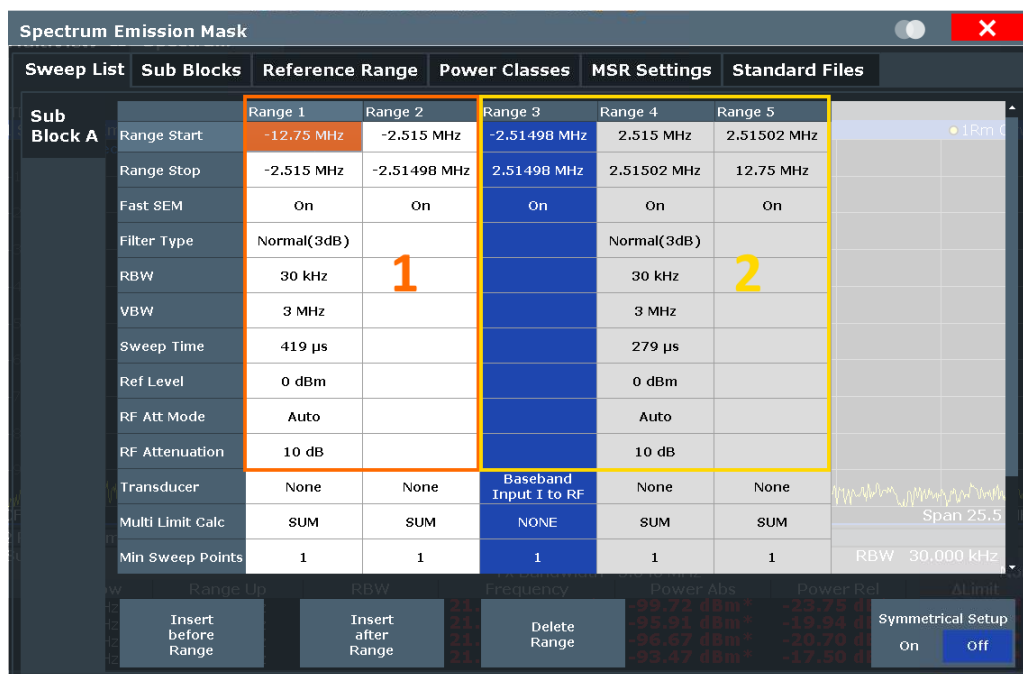

Figure 8-25: Sweep list using Fast SEM mode

In Figure 8-25, a sweep list is shown for which Fast SEM is activated. The formerly five separately defined ranges are combined to two sweep ranges internally.

SEM with Multiple Sub Blocks ("Multi-SEM")

In the Spectrum application application only, spectrum emissions can be measured for multiple sub blocks of channels (also referred to as a "Multi-SEM" measurement). Sub blocks are a set of multiple ranges around a defined center frequency (carrier). Multiple sub blocks can include gaps or overlap, and each sub block defines a separate mask. In the overlapping masks, multi-limit lines are calculated. Up to three sub blocks (with two gaps) can be defined. For each sub block, the familiar configuration settings concerning ranges, limit lines etc. can be defined individually.

Comparison to "traditional" SEM measurement

The default SEM measurement is simply a special case of "Multi-SEM" - consisting of one single block. Only if the number of sub blocks in the basic SEM configuration is larger than 1, multiple sub blocks are inserted in the configuration settings and result tables.

Particular features of configuring multiple sub blocks

The sub blocks are independent of the global start, stop, center and span frequencies for the complete SEM measurement. Thus, there can be gaps that can even include other carrier ranges, but are not configured for the SEM measurement.

For each sub block, you define:

- The center frequency of the reference range of the sub block; center frequencies must be defined in ascending order for sub blocks A,B,C
- The reference range; note that although individual ranges of different sub blocks can overlap, reference ranges for different sub blocks *cannot*; they must define distinct frequency ranges
- The sweep list, including the limit lines



Fast SEM not supported for multiple sub blocks

For SEM with multiple sub blocks, fast SEM is not available. If more than one sub block is defined and a standard is loaded which contains an active fast SEM setting, this setting is disabled.

Absolute vs relative frequencies

In the default configuration with only one sub block, frequencies are defined relative to the center frequency; this is the familiar configuration.

For setups with more than one sub block, frequencies are defined relative to the center frequency of the reference ranges for the individual sub blocks. However, in the result summary, frequencies are indicated as absolute values. Relative frequencies that refer to different reference ranges would be inconvenient and difficult to analyze.

Limit check behavior for overlapping masks

Since spectrum emission masks are defined individually for each sub block, and sub blocks can overlap, the question arises what happens during the limit check in the overlapping regions? To answer this question, we must distinguish the following cases:

- For the reference range, no limit checking is performed, as the reference range contains the carrier
- For other ranges, only the limit lines defined for ranges between the carriers, that is the reference ranges to either side, are significant. In other words: if a limit line definition covers the frequency area of several carriers, only the limit lines for ranges between the corresponding reference range and the next closest reference range are significant.

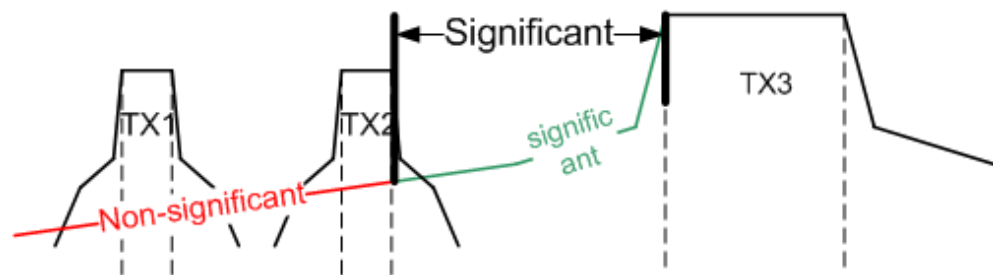

Figure 8-26: Behavior for overlapping masks

- For the ranges in which multiple limit lines are significant, a range-specific function determines the behavior of the limit check

Limit calculation for individual ranges

For each range a function can be defined that determines the behavior of the limit check if there are multiple limit lines:

- **"NONE"** : In reference ranges no limit check is performed; Reference ranges always use the function "NONE" . For other ranges, see the combinations for overlapping ranges below.
- **"SUM"** : sum of the two limit lines (calculated for linear powers) is used
- **"MAX"** : maximum of the two limit lines is used

This leads to the following **combinations for overlapping ranges**:

- **"MAX" + "MAX"** : maximum of the two limit lines is used
- **"MAX" + "SUM"** : maximum of the two limit lines is used
- **"SUM" + "SUM"** : sum of the two limit lines (calculated for linear powers) is used
- **"NONE" + "MAX" / "NONE" + "SUM"** : limit line (and parameters) of the "NONE" range are ignored
- **"NONE" + "NONE"** : depends on the position of the overlapping ranges in relation to the mid-frequency between the two neighboring sub blocks:
 - Overlap is completely *below* the mid-frequency: limits and parameters of the left sub block are used
 - Overlap is completely *above* the mid-frequency: limits and parameters of the right sub block are used
 - Overlap crosses the mid-frequency: new subranges are created: one to the left of the mid-frequency, one to the right of the mid-frequency. The left subrange uses the limits and parameters of the left sub block, the right subrange uses the limits and parameters of the right sub block.



Different RBWs in overlapping ranges

If different RBWs are defined for the overlapping ranges, the following parameters from the range with the smaller RBW are considered for both ranges:

- RBW
- VBW
- Attenuation
- Reference level
- Transducer
- Filter type
- (proportional) sweep time

In the range with the higher RBW, the following offset is applied to the limit line:

$$-10 \cdot \log(RBW_{large} / RBW_{small})$$

Table 8-12: Limit lines in overlapping ranges crossing the mid-frequency

<p>The diagram shows a frequency spectrum with two sub-blocks, Sub block 1 and Sub block 2, separated by a mid-frequency region. Two overlapping ranges, Range 4 and Range 5, are shown. Range 4 is labeled "None" and Range 5 is labeled "None". The ranges overlap and cross the mid-frequency between sub blocks 1 and 2. The diagram also shows Range 3 and Range 6, and two transmitters TX1 and TX2.</p>	<p>The diagram shows the same frequency spectrum as the initial situation, but with the overlapping ranges split into subranges. Subrange 4a is created on the left side of the mid-frequency, and Subrange 5a is created on the right side. Subrange 4a is labeled "Range 3 applies" and Subrange 5a is labeled "Range 6 applies".</p>
<p>Initial situation: overlapping ranges Range 4 ("None") + Range 5 ("None") overlap and cross the mid-frequency between sub blocks 1 and 2</p>	<p>Result: Subranges 4a and 5a are created left and right of the mid-frequency; For subrange 4a: limit line and parameters of range 4 apply For subrange 5a: limit line and parameters of range 5 apply</p>

Global SEM limit check

For the complete SEM measurement, which can consist of multiple sub blocks, only one single limit check is performed. A single limit line is calculated according to the individual range limit lines and the defined functions for overlapping ranges. The measured values are then compared with this single limit line. If the limit is exceeded in any range, the result of the limit check is . " failed!"

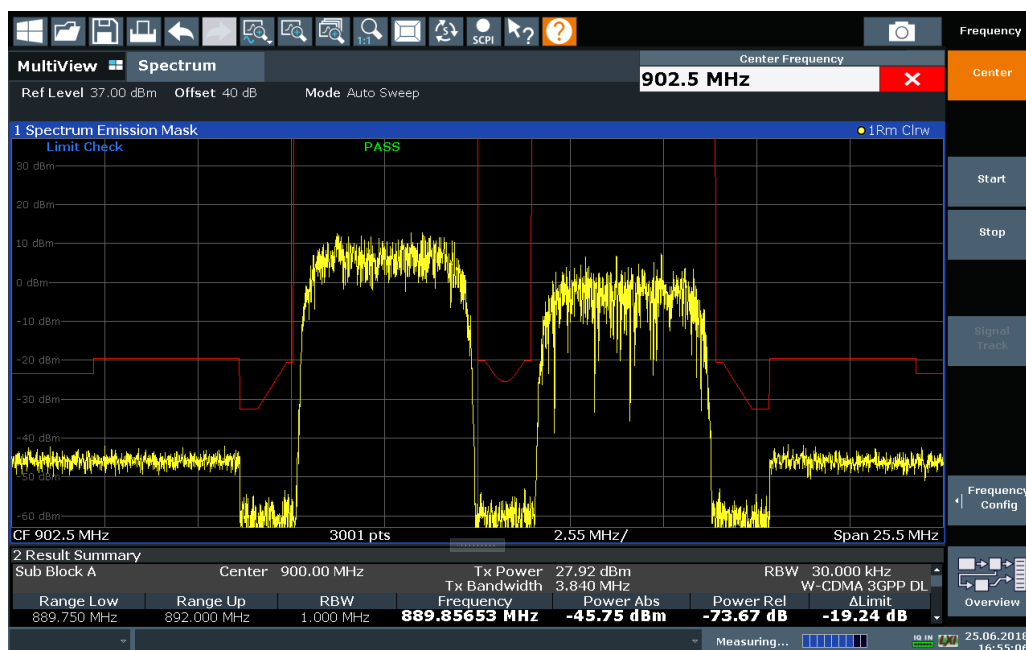

Figure 8-27: Summarized limit line for multiple sub blocks

8.2.6.5 SEM Configuration

Access: "Overview" > "Select Measurement" > "Spectrum Emission Mask"

The SEM measurement is started immediately with the default settings.

The remote commands required to perform these tasks are described in [Chapter 9.6.6, "Measuring the Spectrum Emission Mask"](#), on page 615.



Global span settings

The span of the signal to be monitored is configured in the general span settings (see [Chapter 8.4.2, "Frequency and Span Settings"](#), on page 420). Only ranges within this global span are considered for the SEM measurement.



Multi-SEM configuration

In the Spectrum application application only, spectrum emissions can be measured for multiple sub blocks of channels (see ["SEM with Multiple Sub Blocks \("Multi-SEM"\)"](#) on page 304). Up to three sub blocks (with two gaps) can be defined. For each sub block, the familiar configuration settings concerning ranges, limit lines etc. can be defined in individual tabs. In addition, settings on the sub blocks themselves must be configured in the "Sub Block" tab of the "Spectrum Emission Mask" configuration dialog box (see ["Multi-SEM \(Sub Block\) Settings"](#) on page 314).

The following settings are available in individual tabs of the "Spectrum Emission Mask" configuration dialog box.

- Sweep List309
- Multi-SEM (Sub Block) Settings 314
- Reference Range..... 315
- Power Classes..... 317
- Standard Files..... 318
- List Evaluation (Results Configuration)..... 320

Sweep List

Access: "Overview" > "Select Measurement" > "Spectrum Emission Mask" > "Sweep List"

For SEM measurements, the input signal is split into several frequency ranges which are swept individually and for which different limitations apply. You configure the individual frequency ranges and mask limits in the "Sweep List" .



If you edit the sweep list, always follow the rules and consider the limitations described in "Ranges and Range Settings" on page 299.

Spectrum Emission Mask X

Sweep List	Sub Blocks	Reference Range	Power Classes	MSR Settings	Standard Files
Sub Block A	Range Start	-12.75 MHz	-2.515 MHz	2.515 MHz	
	Range Stop	-2.515 MHz	2.515 MHz	12.75 MHz	
	Fast SEM	Off	Off	Off	
	Filter Type	Normal(3dB)	Normal(3dB)	Normal(3dB)	
	RBW	30 kHz	30 kHz	30 kHz	
	VBW	3 MHz	3 MHz	3 MHz	
	Sweep Time Mode	Auto	Auto	Auto	
	Sweep Time	140 µs	140 µs	140 µs	
	Ref Level	0 dBm	0 dBm	0 dBm	
	RF Att Mode	Auto	Auto	Auto	
	RF Attenuation	10 dB	10 dB	10 dB	
	Preamp	Off	Off	Off	
	Transducer	None	None	None	
	Multi Limit Calc	SUM	NONE	SUM	
	Min Sweep Points	1	1	1	
Limit Check 1	Relative	Relative	Relative		
Rel Limit Start 1	-50 dBc	300 dBc	-50 dBc		

Insert before Range
Insert after Range
Delete Range
Symmetrical Setup

- Range Start / Range Stop 310
- Fast SEM 310
- Filter Type 310
- RBW 310
- VBW 311
- Sweep Time Mode 311
- Sweep Time 311
- Ref Level 311
- RF Att Mode 311

RF Attenuation	311
Preamp	312
Transducer Factor	312
Limit Check <n>	312
Abs Limit Start / Stop <n>	312
Rel Limit Start / Stop <n>	312
Multi-Limit Calc <n>	313
Min Sweep Points	313
Insert before Range / Insert after Range	314
Delete Range	314
Symmetrical Setup	314

Range Start / Range Stop

Sets the start frequency/stop frequency of the selected range.

To change the start/stop frequency of the first or last range, respectively, select the appropriate span in the [SPAN] configuration dialog. You can set a span that is smaller than the overall span of the ranges. In this case, the measurement includes only the ranges that lie within the defined span and have a minimum span of 20 Hz. The first and last ranges are adapted to the given span as long as the minimum span of 20 Hz is not violated.

Define frequency values for each range relative to the center frequency. Center the reference range on the center frequency. The current "Tx Bandwidth" defines the minimum span of the reference range (see "[Channel Power Settings](#)" on page 316).

Remote command:

`[SENSe:]LIST:RANGe<ri>[:FREQuency]:START` on page 622

`[SENSe:]LIST:RANGe<ri>[:FREQuency]:STOP` on page 623

Fast SEM

Activates "Fast SEM" mode for all ranges in the sweep list. For details, see "[Fast SEM Measurements](#)" on page 303.

Note: If you deactivate "Fast SEM" mode while "Symmetrical Setup" mode is on, "Symmetrical Setup" mode is automatically also deactivated.

If you activate "Fast SEM" mode while "Symmetrical Setup" mode is on, not all range settings can be configured symmetrically automatically.

Remote command:

`[SENSe:]ESpectrum<sb>:HSPeed` on page 620

Filter Type

Sets the filter type for this range.

For details on filter types, see [Chapter 8.6.1.6, "Which Data May Pass: Filter Types"](#), on page 438.

Remote command:

`[SENSe:]ESpectrum<sb>:RANGe<ri>:FILTer:TYPE` on page 621

RBW

Sets the resolution bandwidth for this range.

For details on the RBW, see [Chapter 8.6.1.1, "Separating Signals by Selecting an Appropriate Resolution Bandwidth"](#), on page 435.

Remote command:

`[SENSe:]ESpectrum<sb>:RANGe<ri>:BANDwidth:RESolution` on page 620

VBW

Sets the video bandwidth for this range.

For details on the VBW, see [Chapter 8.6.1.2, "Smoothing the Trace Using the Video Bandwidth"](#), on page 436.

Remote command:

`[SENSe:]ESpectrum<sb>:RANGe<ri>:BANDwidth:VIDeo` on page 621

Sweep Time Mode

Activates or deactivates the auto mode for the sweep time.

Currently, only auto mode is available for the R&S FPL1000.

For details on the sweep time mode, see [Chapter 8.6.1.7, "How Long the Data is Measured: Sweep Time"](#), on page 439

Remote command:

`[SENSe:]ESpectrum<sb>:RANGe<ri>:SWEep:TIME:AUTO` on page 632

Sweep Time

Sets the sweep time value for the range.

For details on the sweep time, see [Chapter 8.6.1.7, "How Long the Data is Measured: Sweep Time"](#), on page 439

Remote command:

`[SENSe:]ESpectrum<sb>:RANGe<ri>:SWEep:TIME` on page 631

Ref Level

Sets the reference level for the range.

For details on the reference level, see [Chapter 8.5.1.1, "Reference Level"](#), on page 426.

Remote command:

`[SENSe:]ESpectrum<sb>:RANGe<ri>:RLEVel` on page 631

RF Att Mode

Activates or deactivates the auto mode for RF attenuation.

For details on attenuation, see [Chapter 8.5.1.2, "RF Attenuation"](#), on page 428.

Remote command:

`[SENSe:]ESpectrum<sb>:RANGe<ri>:INPut:ATTenuation:AUTO` on page 623

RF Attenuation

Sets the attenuation value for the range.

Remote command:

`[SENSe:]ESpectrum<sb>:RANGe<ri>:INPut:ATTenuation` on page 623

Preamp

Switches the preamplifier on or off.

For details on the preamplifier, see " [Preamplifier](#) " on page 432.

Remote command:

`[SENSe:]ESpectrum<sb>:RANGe<ri>:INPut:GAIN:STATe` on page 624

Transducer Factor

Sets a transducer for the specified range. You can only choose a transducer that fulfills the following conditions:

- The transducer overlaps or equals the span of the range.
- The x-axis is linear.
- The unit is dB.

For details on transducers, see [Chapter 7.3.6.1, "Basics on Transducer Factors"](#), on page 152.

Remote command:

`[SENSe:]ESpectrum<sb>:RANGe<ri>:TRANsducer` on page 632

Limit Check <n>

Sets the type of limit check for the n-th power class in the range. Up to four limits are possible.

For details on limit checks, see "[Limit Lines in SEM Measurements](#)" on page 301.

The limit state affects the availability of all limit settings.

Remote command:

`[SENSe:]ESpectrum<sb>:RANGe<ri>:LIMit:STATe` on page 629
`CALCulate<n>:LIMit:FAIL?` on page 858

Abs Limit Start / Stop <n>

Sets an absolute limit value for the n-th power class at the start or stop frequency of the range [dBm].

Remote command:

`[SENSe:]ESpectrum<sb>:RANGe<ri>:LIMit:ABSolute:START`
on page 625

`[SENSe:]ESpectrum<sb>:RANGe<ri>:LIMit:ABSolute:STOP`
on page 625

Rel Limit Start / Stop <n>

Sets a relative limit value for the n-th power class at the start or stop frequency of the range [dBc].

By default, this value is a fixed relative limit, i.e. no function is defined. To define a function for the relative limit, select the input field for "Rel Limit Start" or "Rel Limit Stop" and then the "f(x)" icon that appears.

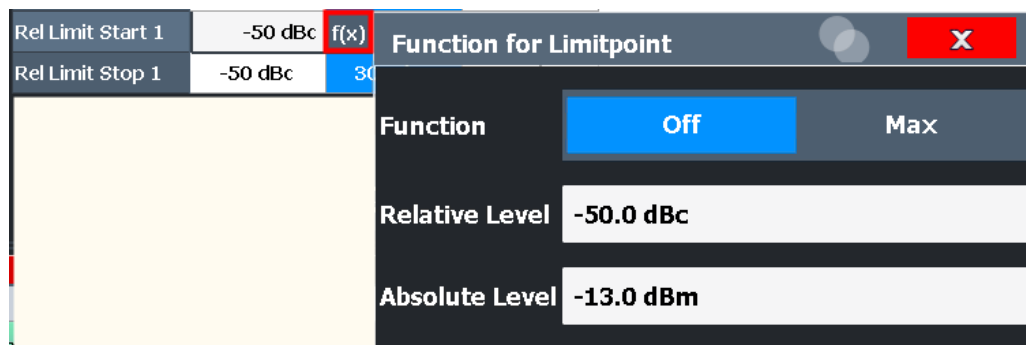

If the function is set to "Max", you can define a relative *and* an absolute limit level. In this case, the maximum of the two values is used as the limit level.

For more information, see ["Relative limit line functions"](#) on page 302.

Remote command:

`[SENSe:]ESpectrum<sb>:RANGe<ri>:LIMit:RELative:START`
on page 626

`[SENSe:]ESpectrum<sb>:RANGe<ri>:LIMit:RELative:STOP`
on page 628

`[SENSe:]ESpectrum<sb>:RANGe<ri>:LIMit:RELative:START:`
`FUNction` on page 627

`[SENSe:]ESpectrum<sb>:RANGe<ri>:LIMit:RELative:STOP:FUNction`
on page 629

`[SENSe:]ESpectrum<sb>:RANGe<ri>:LIMit:RELative:START:ABS`
on page 626

`[SENSe:]ESpectrum<sb>:RANGe<ri>:LIMit:RELative:STOP:ABS`
on page 628

Multi-Limit Calc <n>

Defines the function used to calculate the limit line for the n-th power class for overlapping ranges in Multi-SEM measurements. For details, see ["Limit calculation for individual ranges"](#) on page 306.

"NONE" (reference ranges only:) the limit of the reference range is used

"SUM" Sum of the two limit lines (calculated for linear powers) is used

"MAX" Maximum of the two limit lines is used

Remote command:

`[SENSe:]ESpectrum<sb>:RANGe<ri>:MLCalc` on page 630

Min Sweep Points

Defines the minimum number of sweep points for the range.

If necessary to fulfill all minimum sweep point requirements in all ranges, the global [Sweep Points](#) setting is increased. By default, each range is supplied with a minimum of one sweep point.

For details, see ["Sweep points"](#) on page 300

Remote command:

`[SENSe:]ESpectrum<sb>:RANGe<ri>:POINTs:MINinum[:VALue]` on page 630

Insert before Range / Insert after Range

Inserts a new range to the left (before) or to the right (after) of the range in which the cursor is currently displayed. The range numbers of the currently focused range and all higher ranges are increased accordingly. The maximum number of ranges is 30.

Remote command:

`[SENSe:]ESpectrum<sb>:RANGe<ri>:INSert` on page 624

Delete Range

Deletes the currently focused range, if possible. (The reference range cannot be deleted. A minimum of three ranges is required.) The range numbers are updated accordingly.

Remote command:

`[SENSe:]ESpectrum<sb>:RANGe<ri>:DELete` on page 621

Symmetrical Setup

Any changes to the range settings in active "Symmetrical Setup" mode lead to symmetrical changes in the other ranges (where possible). In particular, this means:

- Inserting ranges: a symmetrical range is inserted on the other side of the reference range
- Deleting ranges: the symmetrical range on the other side of the reference range is also deleted
- Editing range settings: the settings in the symmetrical range are adapted accordingly

Note: If "Fast SEM" mode is deactivated while "Symmetrical Setup" mode is on, "Sym Setup" mode is automatically also deactivated.

If "Fast SEM" mode is activated while "Symmetrical Setup" mode is on, not all range settings can be set automatically.

Remote command:

`[SENSe:]ESpectrum<sb>:SSETup` on page 633

Multi-SEM (Sub Block) Settings

Access: "Overview" > "Select Measurement" > "Spectrum Emission Mask" > "Sub Blocks"

In the Spectrum application application only, spectrum emissions can be measured for multiple sub blocks of channels (see "[SEM with Multiple Sub Blocks \("Multi-SEM"\)](#)" on page 304). Sub blocks are a set of multiple ranges around a defined center frequency (carrier).

By default, a single sub block is assumed. If more than one sub blocks are defined, additional tabs are inserted for each sub block in the individual tabs of the "Spectrum Emission Mask" configuration dialog box.

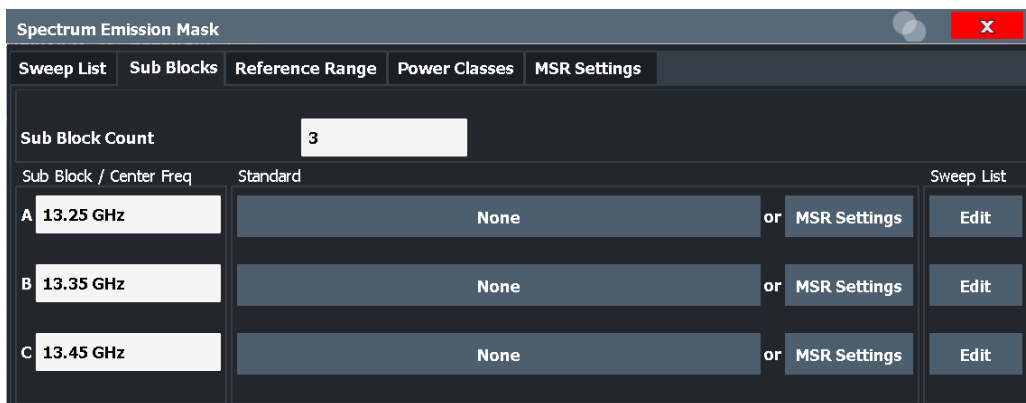

Sub Block Count 315
 Sub Block / Center Freq 315
 Standard 315
 Edit Sweep List 315

Sub Block Count

Defines the number of sub blocks. By default, the familiar SEM measurement with just one single block of ranges is configured.

Remote command:

[SENSe:]ESpectrum<sb>:SCount on page 619

Sub Block / Center Freq

Defines the center frequency for an individual sub block. The center frequency determines the reference range used for each block.

For measurements with only one sub block, this setting corresponds to the global setting in the "Frequency" settings (see [Center Frequency](#)).

Remote command:

[SENSe:]ESpectrum<sb>:SCENTER on page 618

Standard

Defines the use of a standard settings file for a particular sub block. For details, see ["Standard Files"](#) on page 318.

Remote command:

[SENSe:]ESpectrum<sb>:PRESet[:STANdard] on page 616

Edit Sweep List

Switches to the "Sweep List" tab of the "Spectrum Emission Mask" dialog box to configure the individual frequency ranges and mask limits for the corresponding sub block. See ["Sweep List"](#) on page 309.

Reference Range

Access: "Overview" > "Select Measurement" > "Spectrum Emission Mask" > "Reference Range"

The range around the center frequency is defined as the reference range for all other ranges in the sweep list.

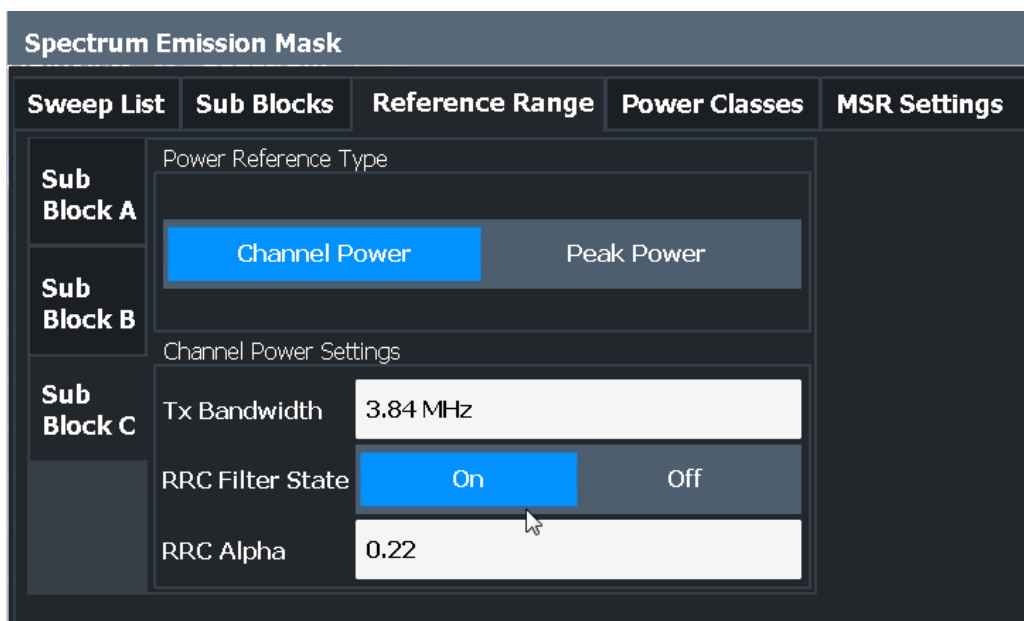

Power Reference Type316
 Channel Power Settings316
 L Tx Bandwidth 316
 L RRC Filter State316
 L Alpha:317

Power Reference Type

Defines how the reference power is calculated.

"Channel Power"

Measures the channel power within the reference range using the integration bandwidth method. Additional settings can be configured for this method.

"Peak Power"

Determines the peak power within the reference range.

Remote command:

[SENSe:]ESpectrum<sb>:RTYPE on page 634

Channel Power Settings

If the "Power Reference Type:" "Channel Power" was selected, additional parameters can be configured.

Tx Bandwidth ← Channel Power Settings

Defines the bandwidth used for measuring the channel power, with:

Minimum span ≤ "Tx Bandwidth" ≤ of reference range

Remote command:

[SENSe:]ESpectrum<sb>:BWID on page 633

RRC Filter State ← Channel Power Settings

Activates or deactivates the use of an RRC filter.

Remote command:

[SENSe:]ESpectrum<sb>:FILTer[:RRC][:STATe] on page 634

Alpha: ← **Channel Power Settings**

Sets the alpha value of the RRC filter (if activated).

Remote command:

[SENSe:]ESpectrum<sb>:FILTer[:RRC]:ALPHa on page 633

Power Classes

Access: "Overview" > "Select Measurement" > "Spectrum Emission Mask" > "Power Classes"

You can configure power classes which you can then assign to sweep list ranges. For details, see "Power classes" on page 300.

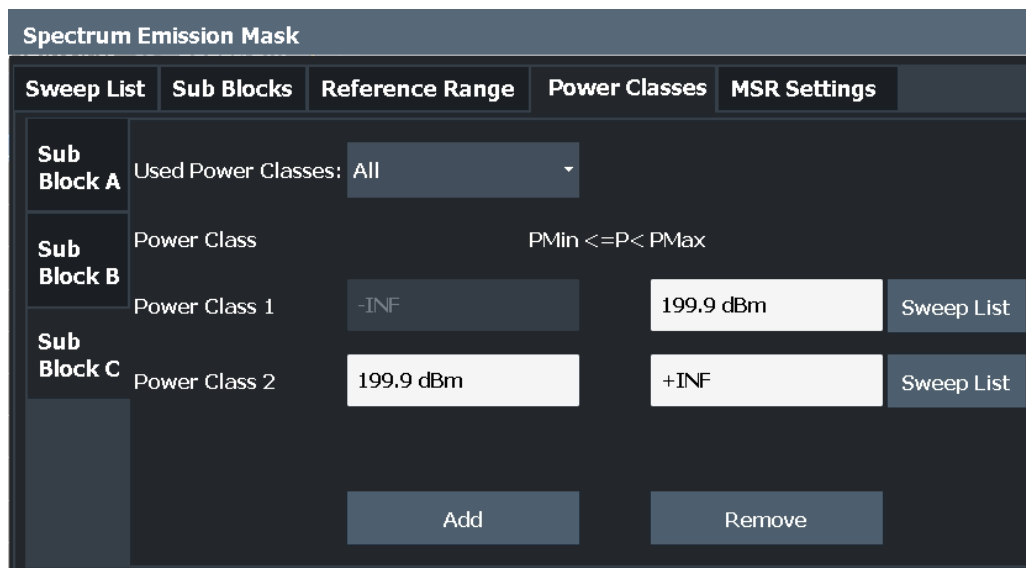

Used Power Classes:317
 PMin / PMax318
 Sweep List318
 Adding or Removing a Power Class 318

Used Power Classes:

Defines which power classes are considered for the SEM measurement. Limits can be defined only for used power classes. It is only possible to select either one specific power class or all the defined power classes.

If "All" is selected, the power class that corresponds to the currently measured power in the reference range is used for monitoring. The limits assigned to that power class are applied (see "Abs Limit Start / Stop <n>" on page 312 and "Rel Limit Start / Stop <n>" on page 312).

Remote command:

`CALCulate<n>:LIMit:ESpectrum<sb>:PCLass<pc>[:EXCLusive]`

on page 637

To define all limits in one step:

`CALCulate<n>:LIMit:ESpectrum<sb>:PCLass<pc>:LIMit[:STATe]`

on page 638

PMin / PMax

Defines the power limits for each power class. The first range always starts at -200 dBm (-INF) and the last range always stops at 200 dBm (+INF). These fields cannot be modified. If more than one power class is defined, the value of "PMin" must be equal to the value of "PMax" of the previous power class and vice versa.

Note that the power level can be equal to the lower limit(s), but must be lower than the upper limit(s):

$$P_{\min} \leq P < P_{\max}$$

Otherwise the ranges are corrected automatically.

Remote command:

`CALCulate<n>:LIMit:ESpectrum<sb>:PCLass<pc>:MINimum`

on page 639

`CALCulate<n>:LIMit:ESpectrum<sb>:PCLass<pc>:MAXimum`

on page 639

Sweep List

Switches to the "Sweep List" tab of the "Spectrum Emission Mask" dialog box and focuses the "Limit Check" setting for the corresponding power class (1-4) in the reference range (see "Limit Check <n>" on page 312).

Adding or Removing a Power Class

Adds a new power class at the end of the list or removes the last power class. After adding or removing, the last power class is adapted to end at "+INF". Note that a maximum of four power classes are available.

Remote command:

`CALCulate<n>:LIMit:ESpectrum<sb>:PCLass<pc>:COUNT` on page 637

Standard Files

Access: "Overview" > "Select Measurement" > "Spectrum Emission Mask" > "Standard Files"

You can save the current measurement settings as a user-defined standard (XML file), or load stored measurement settings. Furthermore, you can delete an existing settings file.

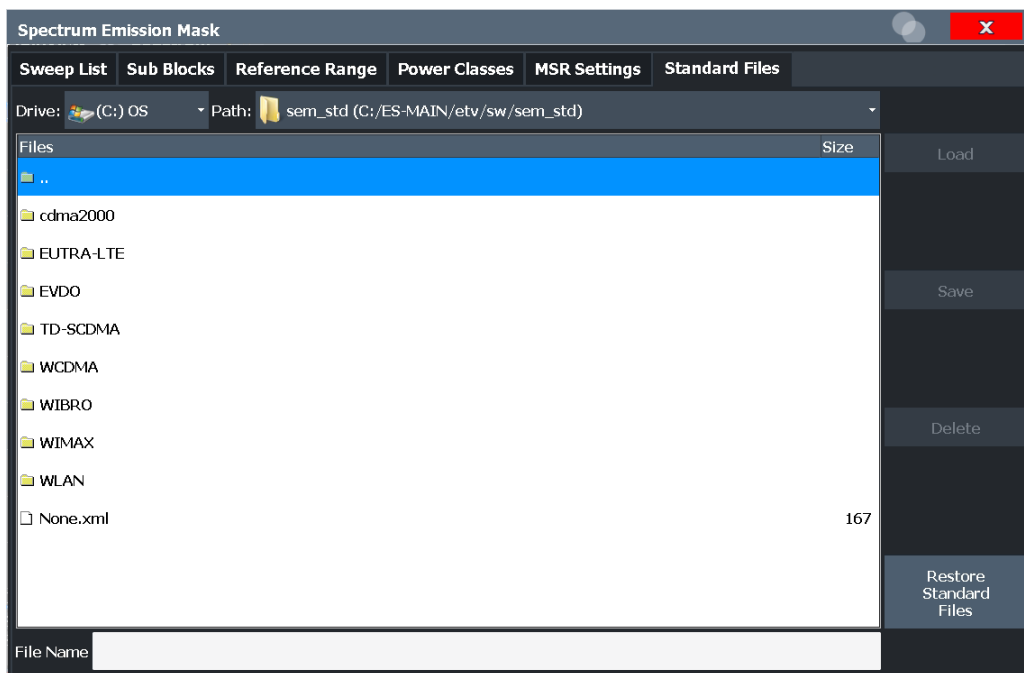

For details, see "How to Manage SEM Settings Files" on page 324.



Standard files for sub blocks (Multi-SEM measurements)

If more than one sub blocks are defined, the "Standard Files" tab and softkey are not available. To load a standard file for an individual sub block, use the [Multi-SEM \(Sub Block\) Settings](#) setting in the "Sub Blocks" tab.

Selecting Storage Location - Drive/ Path/ Files	319
File Name	319
Load Standard	320
Save Standard	320
Delete Standard	320
Restore Standard Files	320

Selecting Storage Location - Drive/ Path/ Files

Select the storage location of the file on the instrument or an external drive.

The default storage location for the SEM settings files is:

C:\ProgramData\Rohde-Schwarz\ZNL-FPL\sem_std.

Remote command:

[MMEMory:CATalog](#) on page 863

File Name

Contains the name of the data file without the path or extension.

By default, the name of a user file consists of a base name followed by an underscore. Multiple files with the same base name are extended by three numbers, e.g.

limit_lines_005.

File names must be compatible with the Windows conventions for file names. In particular, they must not contain special characters such as ":", "*", "?".

For details on the filename and location, see ["Storage Location and Filename"](#) on page 107.

Load Standard

Loads the selected measurement settings file.

Remote command:

`[SENSe:]ESpectrum<sb>:PRESet[:STANdard]` on page 616

Save Standard

Saves the current measurement settings for a specific standard as a file with the defined name.

Remote command:

`[SENSe:]ESpectrum<sb>:PRESet:STORe` on page 617

Delete Standard

Deletes the selected standard. Standards predefined by Rohde & Schwarz can also be deleted. A confirmation query is displayed to avoid unintentional deletion of the standard.

Note: Restoring predefined standard files. The standards predefined by Rohde & Schwarz available at the time of delivery can be restored using the "Restore Standard Files" function (see ["Restore Standard Files"](#) on page 320).

Restore Standard Files

Restores the standards predefined by Rohde & Schwarz available at the time of delivery.

The XML files from the `C:\ProgramData\Rohde-Schwarz\ZNL-FPL\sem_backup` folder are copied to the `C:\ProgramData\Rohde-Schwarz\ZNL-FPL\sem_std` folder.

Note that this function will overwrite customized standards that have the same name as predefined standards.

Remote command:

`[SENSe:]ESpectrum<sb>:PRESet:RESTore` on page 617

List Evaluation (Results Configuration)

Access: "Overview" > "Select Measurement" > "Spectrum Emission Mask" > "List Evaluation"

In the "List Evaluation" dialog box, you configure the contents and display of the SEM results.

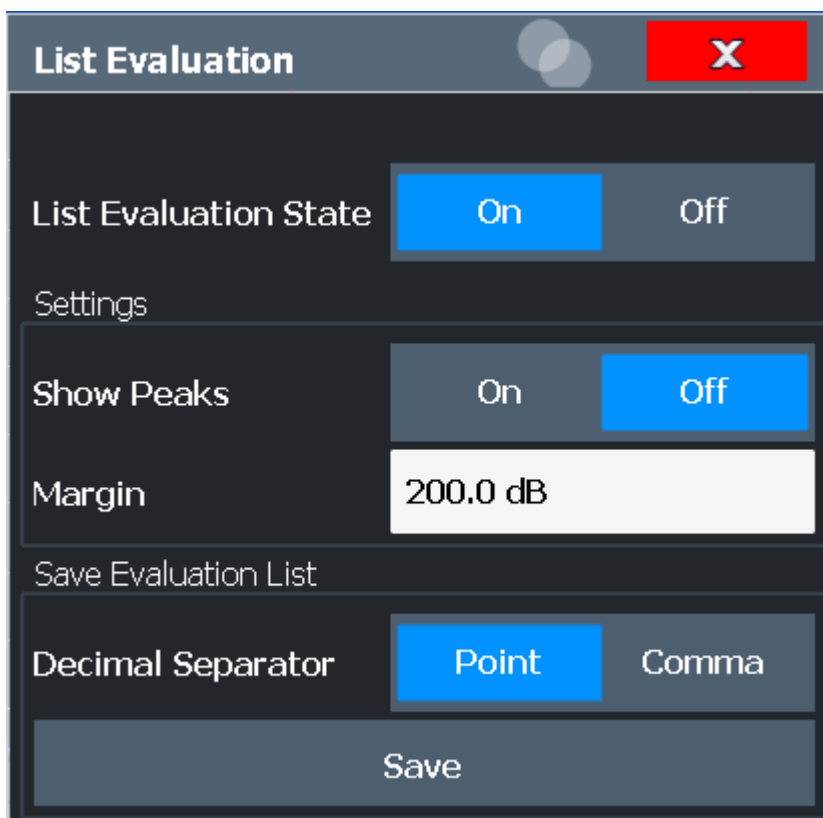

List Evaluation State (Result Summary)..... 321
 Show Peaks 321
 Margin 321
 Saving the Result Summary (Evaluation List) to a File 322

List Evaluation State (Result Summary)

Activates or deactivates the Result Summary.

Remote command:

[CALCulate<n>:ESpectrum:PEAKsearch:AUTO](#) on page 640

[TRACe<n>\[:DATA\]](#) on page 776

Show Peaks

If activated, all peaks that have been detected during an active SEM measurement are marked with blue squares in the Spectrum diagram.

Remote command:

[CALCulate<n>:ESpectrum:PEAKsearch:PSHow](#) on page 641

Margin

Although a margin functionality is not available for the limit check, you can define a margin (or: *threshold*) for the peak values to be displayed in the result summary. Only peaks that exceed the margin value are displayed (also in the diagram, if activated).

Remote command:

[CALCulate<n>:ESpectrum:PEAKsearch:MARGIN](#) on page 641

Saving the Result Summary (Evaluation List) to a File

Exports the Result Summary of the SEM measurement to an ASCII file for evaluation in an external application. If necessary, change the decimal separator for evaluation in other languages.

Define the filename and storage location in the file selection dialog box that is displayed when you select the "Save" function.

For details, see ["ASCII File Export Format \(Spectrum Emission Mask\)"](#) on page 333.

Remote command:

`MMEMoRY:STORe<n>:LIST` on page 887

`FORMat:DEXPort:DSEParator` on page 863

8.2.6.6 How to Perform a Spectrum Emission Mask Measurement

SEM measurements can be performed according to a specific standard or freely configured. Configuration for signals with a regular channel definition can be configured quickly and easily. Selecting the SEM measurement is a prerequisite for all other tasks.

For signals with multiple carriers, also in non-contiguous ranges, an SEM measurement with multiple sub blocks can be configured.

The following tasks are described:

- ["To select an SEM measurement"](#) on page 322
- ["To perform an SEM measurement according to a standard"](#) on page 322
- ["To configure a user-defined SEM measurement"](#) on page 322
- ["To perform a Multi-SEM measurement"](#) on page 324



For remote operation, see [Chapter 9.6.6.10, "Example: SEM Measurement"](#), on page 642.

To select an SEM measurement

- ▶ Press the [MEAS] key, then select the "Spectrum Emission Mask" measurement.

To perform an SEM measurement according to a standard

- ▶ Load the settings file as described in ["How to load an SEM settings file"](#) on page 325 and start a measurement.

To configure a user-defined SEM measurement

1. Define the span of the signal you want to monitor in the general span settings.
2. Split the frequency span of the measurement into ranges for signal parts with similar characteristics.

Starting from the center frequency, determine which sections of the signal to the left and right can be swept and monitored using the same parameters. Criteria for such a range definition may be, for example:

- The signal power level

- The required resolution bandwidth or sweep time
- Transducer factors
- Permitted deviation from the defined signal level, i.e. the required limit values for monitoring

If the signal consists of a transmission channel and adjacent channels, the channel ranges can usually be used for the range definition.

3. If the signal power level to be monitored varies and the limits vary, define power classes. For each range of levels that can be monitored in the same way, define a power class.
 - a) Select the "Overview" softkey.
 - b) Select the "SEM Setup" button.
 - c) Switch to the "Power Classes" tab.
 - d) To add a power class, select the "Add" button.
 - e) Enter the start and stop power levels to define the class.
 - f) Select the power classes to be used for the current measurement:
 - a specific class
 - all classes, to have the required class selected automatically according to the input level measured in the reference range
4. Select the "Sweep List" tab of the "Spectrum Emission Mask" dialog box.
5. Insert the required ranges using the "Insert before Range" and "Insert after Range" buttons, which refer to the currently selected range (the reference range by default).

If the signal trace is symmetric to the center frequency, activate the "Sym Setup" option to make setup easier and quicker.
6. Define the measurement parameters for each range as required. If symmetrical setup is activated, you only have to configure the ranges to one side of the center range.

In particular, define the limits for each range of the signal, i.e. the area in which the signal level can deviate without failing the limit check. If several power classes were defined (see [step 3](#)), define limits for each power class.

 - a) Define the type of limit check, i.e. whether absolute values or relative values are checked, or both. The type of limit check is identical for all power classes.
 - b) Define the limit start and stop values.
7. If the sweep list settings - other than the limit and transducer values - are identical for several adjacent ranges, activate "Fast SEM" mode to speed up the measurement. You only have to activate the mode for one range, the others are adapted automatically.
8. If necessary, change the settings for the reference power to which all SEM results refer in the "Reference Range" tab.
9. To indicate the determined peaks in the display during an SEM measurement, select "Overview" > "Analysis" > "Show Peaks" .

10. To save the current SEM measurement settings to a file to re-use them later, save a settings file as described in ["How to save a user-defined SEM settings file"](#) on page 325.
11. Start a sweep.
The determined powers and limit deviations for each range are indicated in the Result Summary. If activated, the peak power levels for each range are also indicated in the Spectrum diagram.
12. To save the Result Summary, export the results to a file as described in ["How to Save SEM Result Files"](#) on page 325.

To perform a Multi-SEM measurement

1. Define the span of the signal to be monitored in the general span settings.
2. Select the "Multi-SEM Config" softkey.
3. Define the number of sub blocks (up to 3) that contain the relevant carriers.
4. For each sub block, define the center frequency, that is, the frequency of the TX carrier or a frequency in the dedicated reference range.
5. For each sub block, do one of the following:
 - Select a standard settings file to be used.
 - Select the "Edit" button and configure the sweep list manually as defined in ["To configure a user-defined SEM measurement"](#) on page 322. Be sure to select the correct vertical tab for the corresponding sub block within each subtab of the "Spectrum Emission Mask" configuration dialog.
Define a function to be used for overlapping ranges in the "Multi-Limit Calc" field of the sweep list.
6. Start a sweep.
The determined powers and limit deviations for each sub block, each gap, and each range are indicated in the Result Summary. If activated, the peak power levels for each range are also indicated in the Spectrum diagram.
7. To save the Result Summary, export the results to a file as described in ["How to Save SEM Result Files"](#) on page 325.

How to Manage SEM Settings Files

SEM measurement settings can be saved to an XML file which can then be exported to another application or loaded on the R&S FPL1000 again later. Some predefined XML files are provided that contain ranges and parameters according to the selected standard. All XML files are stored under

```
C:\ProgramData\Rohde-Schwarz\ZNL-FPL\sem_std.
```

For details on the file format of the SEM settings file, see ["Format Description of SEM XML Files"](#) on page 328.

SEM settings or standard files are managed in the "Standard" tab of the "Spectrum Emission Mask" dialog box. To display this dialog box, select the "Overview" softkey and then the "SEM Setup" button.

How to load an SEM settings file

1. From the file selection dialog box, select the settings file (with a `.xml` extension).
2. Select the "Load" button.

The settings from the selected file are restored to the R&S FPL1000 and you can repeat the SEM measurement with the stored settings.

How to save a user-defined SEM settings file

1. Configure the SEM measurement as required (see [Chapter 8.2.6.6, "How to Perform a Spectrum Emission Mask Measurement"](#), on page 322).
2. In the "Standard Files" tab of the "Spectrum Emission Mask" dialog box, define a filename and storage location for the settings file.
3. Select the "Save" button.

The settings are stored to a file with the extension `.xml` as specified.

How to delete an SEM settings file

1. In the "Standard Files" tab of the "Spectrum Emission Mask" dialog box, select the file you want to delete.
2. Select the "Delete" button.
3. Confirm the message.

The settings file is removed from the R&S FPL1000.

How to restore default SEM settings files

The R&S FPL1000 is delivered with predefined settings files which can be edited and overwritten. However, you can restore the original files.

- ▶ In the "Standard Files" tab of the "Spectrum Emission Mask" dialog box, select the "Restore Standard Files" button.

The original predefined settings files are available for selection on the R&S FPL1000.

How to Save SEM Result Files

The Result Summary from an SEM measurement can be saved to a file, which can be exported to another application for further analysis, for example.

For details on the file format of the SEM export file, see ["ASCII File Export Format \(Spectrum Emission Mask\)"](#) on page 333.

1. Configure and perform an SEM measurement as described in [Chapter 8.2.6.6, "How to Perform a Spectrum Emission Mask Measurement"](#), on page 322.
2. In the "Overview" , select the "Analysis" button.
3. If necessary, change the "Decimal Separator" to "COMMA" for evaluation in other languages.
4. Select the "Save" button.
5. In the file selection dialog box, select a storage location and filename for the result file.
6. Select the "Save" button.

The file with the specified name and the extension `.dat` is stored in the defined storage location.

8.2.6.7 Measurement Example: Multi-SEM Measurement

The following measurement example demonstrates an SEM measurement for a signal with multiple sub blocks.



A programming example demonstrating a SEM measurement in a remote environment is provided in [Chapter 9.6.6.10, "Example: SEM Measurement"](#), on page 642.

Test setup:

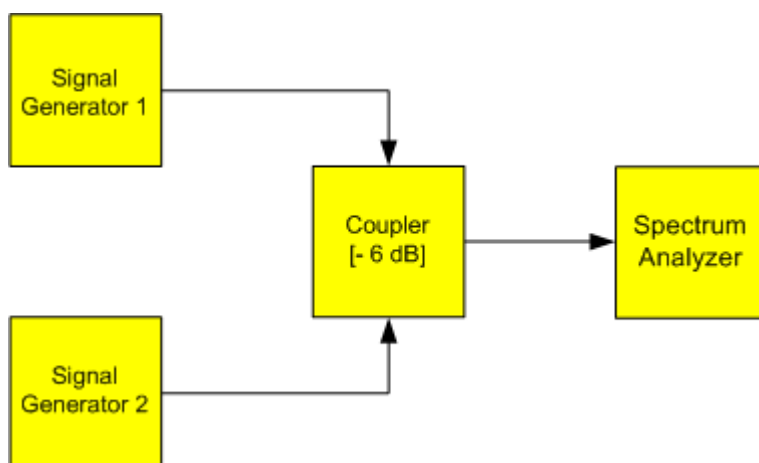

Signal generator settings (e.g. R&S FPL1000 SMW):

Device	Standard	Center frequency	Level	Test model
SigGen 1	3GPP/FDD	900 MHz	0 dBm	1-16
SigGen 2	EUTRA/LTE	906.5 MHz	0 dBm	1_1_5MHz

Setting up the measurement

1. Preset the R&S FPL1000.
2. Set the center frequency to 903.25 MHz.
3. Set the reference level to 10 dBm with an offset of to 30 dB.
4. Press the [MEAS] key or select "Select Measurement" in the "Overview" .
5. Select the "SEM" measurement function.
6. Select the "Sub Blocks" softkey and enter "Sub Block Count" of 2.
7. For "Sub Block A" , define the settings for the 3GPP/FDD signal:
 - Set the "Center Frequency" to 900 MHz
 - Set the "Base Station RF Bandwidth" to 5 MHz.
 - Select "Apply to SEM" .
8. For "Sub Block B" , define the settings for the EUTRA/LTE signal:
 - Set the "Center Frequency" to 906.5 MHz
 - Set the "Base Station RF Bandwidth" to 5 MHz.
 - Select "Apply to SEM" .
9. Select [RUN SINGLE] to perform a measurement with the new settings.

The results of the measurement for each sub block are displayed in the Result Summary. The summarized limit line is indicated in the Spectrum graph.

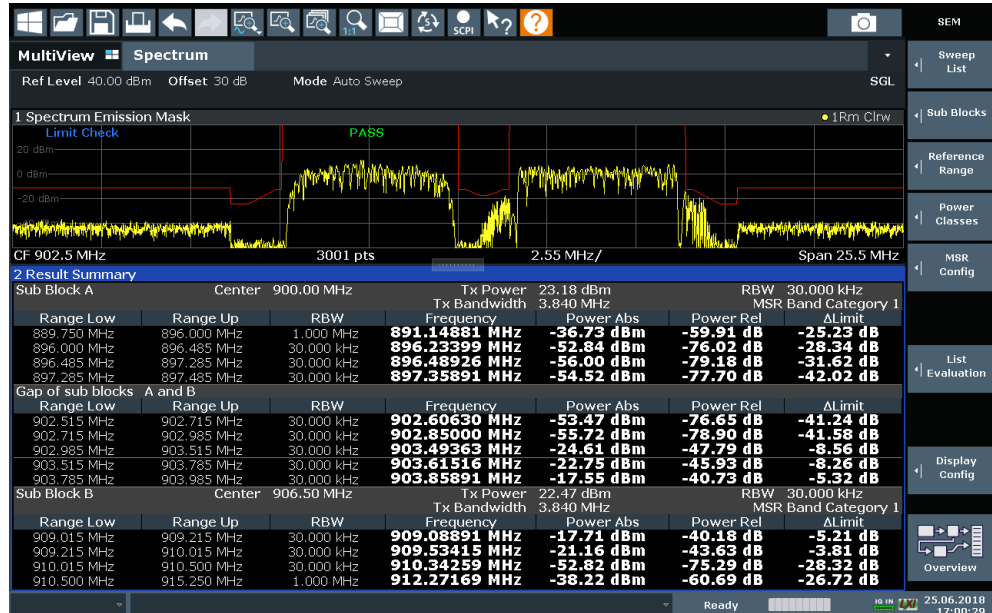

Figure 8-28: Multi-SEM measurement: results of the measurement for each sub block

8.2.6.8 Reference: SEM File Descriptions

This reference provides details on the format of the SEM settings and result files.

- [Format Description of SEM XML Files](#)..... 328
- [ASCII File Export Format \(Spectrum Emission Mask\)](#)..... 333

Format Description of SEM XML Files

The SEM XML files offer a quick way to change the measurement settings. A set of predefined XML files for different standards is already provided. You can also create and use your own XML files. Alternatively, edit the settings directly in the "Spectrum Emission Mask" dialog box and save the XML file afterwards. This way, you do not have to modify the XML file itself.

In addition to saving the current settings to a file, settings files can also be created independently of the R&S FPL1000, in an external application. When creating your own XML files, be sure to comply with the following conventions because the R&S FPL1000 can only interpret XML files of a known structure. For sample files, see the `C:\ProgramData\Rohde-Schwarz\ZNL-FPL\sem_std` directory of the R&S FPL1000.

To load a settings file, use the "Load" function in the "Standard Files" tab of the "Spectrum Emission Mask" dialog box (see ["How to load an SEM settings file"](#) on page 325). All XML files are stored under

`C:\ProgramData\Rohde-Schwarz\ZNL-FPL\sem_std`.

The files for importing range settings obey the rules of the XML standard. The child nodes, attributes, and structure defined for the data import are described here.



Be sure to follow the structure exactly as shown below or else the R&S FPL1000 is not able to interpret the XML file and error messages are shown on the screen. It is recommended that you make a copy of an existing file and edit the copy of the file.

Basically, the file consists of three elements that can be defined:

- The `BaseFormat` element
- The `PowerClass` element
- The `Range` element

The "BaseFormat" element

It carries information about basic settings. In this element, only the `ReferencePower` child node has any effects on the measurement itself. The other attributes and child nodes are used to display information about the Spectrum Emission Mask standard on the measurement screen. The child nodes and attributes of this element are shown in [Table 8-13](#).

Example:

In the sample file `PowerClass_39_43.xml` under

`C:\ProgramData\Rohde-Schwarz\ZNL-FPL\sem_std\WCDMA\3GPP`, these attributes are defined as follows:

- `Standard="W-CDMA 3GPP"`
- `LinkDirection="DL"`
- `PowerClass="(39,43)dBm"`

The "PowerClass" element

It is embedded in the `BaseFormat` element and contains settings information about the power classes. Up to four different power classes can be defined. For details, refer to ["Power Classes"](#) on page 317. The child nodes and attributes of this element are shown in [Table 8-14](#).

The "Range" element

This element is embedded in the `PowerClass` element. It contains the settings information of the range. There have to be at least three defined ranges: one reference range and at least one range to either side of the reference range. The maximum number of ranges is 30. Note that the R&S FPL1000 uses the same ranges in each power class. Therefore, the contents of the ranges of each defined power class have to be identical to the first power class. The `Start` and `Stop` values of the two `Limit` nodes that are used to determine the power class are an exception. Note also that you must define two limit nodes: one that defines the limit in absolute values and one in relative values. Make sure units for the `Start` and `Stop` nodes are identical for each `Limit` node.

For details, refer to ["Sweep List"](#) on page 309. The child nodes and attributes of this element are shown in [Table 8-15](#).

The following tables show the child nodes and attributes of each element and show if a child node or attribute is mandatory for the R&S FPL1000 to interpret the file or not. The hierarchy of the XML cannot be seen in the tables. View one of the predefined files already stored on the R&S FPL1000 in the "C:

`\ProgramData\Rohde-Schwarz\ZNL-FPL\sem_std`" directory, or check the structure as shown below.

Below, a basic example of the structure of the file is shown, containing all mandatory attributes and child nodes. Note that the `PowerClass` element and the `Range` element are themselves elements of the `BaseFormat` element. They must be inserted where noted. They are separated here simply to provide a better overview. Also, no example values are given here to allow a quick reference to the tables above. Italic font shows the placeholders for the values.

- The `BaseFormat` element is structured as follows:
 - `<RS_SEM_ACP_FileFormat Version="1.0.0.0">`
 - `<Name>"Standard"</Name>`
 - `<Instrument>`
 - `<Type>"Instrument Type"</Type>`
 - `<Application>"Application"</Application>`

- ```

</Instrument>
<LinkDirection Name="Name">
<ReferencePower>
<Method>"Method"</Method>
</ReferencePower>
<PowerClass Index="n">
<!-- For contents of the PowerClass node, see Table 8-14 -->
<!-- Define up to four PowerClass nodes -->
</PowerClass>
</LinkDirection>
</RS_SEM_ACP_File>

```
- The "PowerClass" element is structured as follows:
    - <PowerClass Index="n">

```

<StartPower Unit="dBm" InclusiveFlag="true" Value="StartPowerValue"/>
<StopPower Unit="dBm" InclusiveFlag="false" Value="StopPowerValue"/>
<DefaultLimitFailMode>"Limit Fail Mode"</DefaultLimitFailMode>
<Range Index="n">
<!-- For contents of the Range node, see Table 8-15 -->
<!-- Define up to twenty Range nodes -->
</Range>
...
</PowerClass>

```
  - The "Range" element is structured as follows:
    - <Range Index="n">

```

<Name="Name">
<ChannelType>"Channel Type"</Channel Type>
<WeightingFilter>
<Type>"FilterType"</Type>
<RollOffFactor>"Factor"</RollOffFactor>
<Bandwidth>"Bandwidth"</Bandwidth>
</WeightingFilter>
<FrequencyRange>
<Start>"RangeStart"</Start>
<Stop>"RangeStop"</Stop>
</FrequencyRange>
<Limit>
<Start Unit="Unit" Value="Value"/>
<Stop Unit="Unit" Value="Value"/>
</Limit>
<Limit>
<Start Unit="Unit" Value="Value"/>
<Stop Unit="Unit" Value="Value"/>
</Limit>
<RBW Bandwidth="Bandwidth" Type="FilterType"/>
<VBW Bandwidth="Bandwidth"/>
<Detector>"Detector"</Detector>
<Sweep Mode="SweepMode" Time="SweepTime"/>
<Amplitude>
<ReferenceLevel Unit="dBm" Value="Value"/>

```

```

<RFAttenuation Mode="Auto" Unit="dB" Value="Value"/>
<Preamplifier State="State"/>
</Amplitude>
<MeasPointsMin>1</MeasPointsMin>
<CalcRuleMulti>Sum</CalcRuleMulti>
</Range>

```

**Table 8-13: Attributes and child nodes of the BaseFormat element**

| Child Node            | Attribute                                      | Value                       | Parameter Description   | Mand. |
|-----------------------|------------------------------------------------|-----------------------------|-------------------------|-------|
|                       | FileFormatVersion                              | 1.0.0.0                     |                         | Yes   |
|                       | Date                                           | YYYY-MM-DD<br>HH:MM:SS      | Date in ISO 8601 format | No    |
| Name                  |                                                | <string>                    | Name of the standard    | Yes   |
| Instrument            | Type                                           | FSL                         | Name of the instrument  | No    |
|                       | Application                                    | SA   K72   K82              | Name of the application | No    |
| LinkDirection         | Name                                           | Downlink   Uplink  <br>None |                         | Yes   |
|                       | ShortName                                      | DL   UL                     |                         | No    |
| Reference-<br>Power   |                                                |                             |                         | Yes   |
| Method                | TX Channel Power  <br>TX Channel Peak<br>Power |                             |                         | Yes   |
| Reference-<br>Channel | <string>                                       |                             |                         | No    |

**Table 8-14: Attributes and child nodes of the PowerClass element**

| Child Node           | Attribute     | Value                                                                    | Parameter description                                                                                                        | Mand. |
|----------------------|---------------|--------------------------------------------------------------------------|------------------------------------------------------------------------------------------------------------------------------|-------|
| StartPower           | Value         | <power in dBm>                                                           | The start power must be equal to the stop power of the previous power class. The StartPower value of the first range is -200 | Yes   |
|                      | Unit          | dBm                                                                      |                                                                                                                              | Yes   |
|                      | InclusiveFlag | true                                                                     |                                                                                                                              | Yes   |
| StopPower            | Value         | <power in dBm>                                                           | The stop power must be equal to the start power of the next power class. The StopPower value of the last range is 200        | Yes   |
|                      | Unit          | dBm                                                                      |                                                                                                                              |       |
|                      | InclusiveFlag | false                                                                    |                                                                                                                              | Yes   |
| DefaultLimitFailMode |               | Absolute   Relative<br>  Absolute and Relative<br>  Absolute or Relative |                                                                                                                              | Yes   |

Table 8-15: Attributes and child nodes of the Range element (normal ranges)

| Child node      | Attribute  | Value                                                              | Parameter description                                                                                                                                            | Mand.                                                                                  |
|-----------------|------------|--------------------------------------------------------------------|------------------------------------------------------------------------------------------------------------------------------------------------------------------|----------------------------------------------------------------------------------------|
|                 | Index      | 0...19                                                             | Indices are continuous and have to start with 0                                                                                                                  | Yes                                                                                    |
|                 | Name       | <string>                                                           | Name of the range                                                                                                                                                | Only if ReferenceChannel contains a name and the range is the reference range          |
|                 | Short-Name | <string>                                                           | Short name of the range                                                                                                                                          | No                                                                                     |
| ChannelType     |            | TX   Adjacent                                                      |                                                                                                                                                                  | Yes                                                                                    |
| WeightingFilter |            |                                                                    |                                                                                                                                                                  | Only if ReferencePower method is TX Channel Power and the range is the reference range |
| Type            |            | RRC   CFilter                                                      | Type of the weighting filter                                                                                                                                     | Yes                                                                                    |
| Roll Off Factor |            | 0...1                                                              | Excess bandwidth of the filter                                                                                                                                   | Only if the filter type is RRC                                                         |
| Bandwidth       |            | <bandwidth in Hz>                                                  | Filter bandwidth                                                                                                                                                 | Only if the filter type is RRC                                                         |
| FrequencyRange  |            |                                                                    |                                                                                                                                                                  | Yes                                                                                    |
| Start           |            | <frequency in Hz>                                                  | Start value of the range                                                                                                                                         | Yes                                                                                    |
| Stop            |            | <frequency in Hz>                                                  | Stop value of the range                                                                                                                                          | Yes                                                                                    |
| Limit           |            | dBm/Hz   dBm   dBc   dBr   dB                                      | A Range must contain exactly two limit nodes; one of the limit nodes has to have a relative unit (e.g. dBc), the other one must have an absolute unit (e.g. dBm) | Yes                                                                                    |
| Start           | Value      | <numeric_value>                                                    | Power limit at start frequency                                                                                                                                   | Yes                                                                                    |
|                 | Unit       | dBm/Hz   dBm   dBc   dBr   dB                                      | Sets the unit of the start value                                                                                                                                 |                                                                                        |
| Stop            | Value      | <numeric_value>                                                    | Power limit at stop frequency                                                                                                                                    |                                                                                        |
|                 | Unit       | dBm/Hz   dBm   dBc   dBr   dB                                      | Sets the unit of the stop value                                                                                                                                  |                                                                                        |
| LimitFailMode   |            | Absolute   Relative   Absolute and Relative   Absolute or Relative | If used, it has to be identical to DefaultLimitFailMode                                                                                                          | No                                                                                     |
| RBW             | Bandwidth  | <bandwidth in Hz>                                                  | " RBW " on page 310                                                                                                                                              | Yes                                                                                    |

| Child node     | Attribute | Value                                      | Parameter description                             | Mand.                                                 |
|----------------|-----------|--------------------------------------------|---------------------------------------------------|-------------------------------------------------------|
|                | Type      | NORM   PULS  <br>CFIL   RRC                |                                                   | No                                                    |
| VBW            | Bandwidth | <bandwidth in Hz>                          | " VBW " on page 311                               | Yes                                                   |
| Detector       |           | NEG   POS  <br>SAMP   RMS  <br>AVER   QUAS | If used, it has to be identical<br>in all ranges. | No                                                    |
| Sweep          | Mode      | Manual   Auto                              | " Sweep Time Mode "<br>on page 311                | Yes                                                   |
|                | Time      | <time in sec>                              | " Sweep Time " on page 311                        | No                                                    |
| Amplitude      |           |                                            |                                                   | No                                                    |
| ReferenceLevel | Value     | <power in dBm>                             | " Ref Level " on page 311                         | Yes, if the Refer-<br>enceLevel child<br>node is used |
|                | Unit      | dBm                                        | Defines dBm as unit                               | Yes, if the Refer-<br>enceLevel node<br>is used       |
| RFAttenuation  | Mode      | Manual   Auto                              | " RF Att Mode "<br>on page 311                    | Yes, if the Refer-<br>enceLevel child<br>node is used |
| Preamplifier   |           | ON   OFF   1   0                           | " Preamp " on page 312                            | Yes                                                   |

### ASCII File Export Format (Spectrum Emission Mask)

When trace data from an SEM measurement is exported, the data is stored in ASCII format as described below. The first part of the file lists information about the signal analyzer and the general setup.

| File contents                    | Explanation                             |
|----------------------------------|-----------------------------------------|
| <b>File header</b>               |                                         |
| Type;FPL1003                     | Model                                   |
| Version;1.00;                    | Firmware version                        |
| Date;31.Mar 17;                  | Storage date of data set                |
| Mode;ANALYZER;SEM;               | Operating mode and measurement function |
| Center Freq;1325000000.000000;Hz | X-axis settings                         |
| Freq Offset;0.000000;Hz          |                                         |
| Span;25500000.000000;Hz          |                                         |
| x-Axis;LIN;                      |                                         |
| Start;13237250000.000000;Hz      |                                         |
| Stop;13262750000.000000;Hz       |                                         |
| Level Offset;0.000000;dB         | Y-axis settings                         |
| Ref Position;100.000000;%        |                                         |

| File contents                                                                                            | Explanation                                                                                                                                                                                                                                                                                                                                                               |
|----------------------------------------------------------------------------------------------------------|---------------------------------------------------------------------------------------------------------------------------------------------------------------------------------------------------------------------------------------------------------------------------------------------------------------------------------------------------------------------------|
| y-Axis;LOG;                                                                                              |                                                                                                                                                                                                                                                                                                                                                                           |
| Level Range;100.000000;dB                                                                                |                                                                                                                                                                                                                                                                                                                                                                           |
| <b>Trace settings</b>                                                                                    |                                                                                                                                                                                                                                                                                                                                                                           |
| Trace Mode;CLR/WRITE;                                                                                    |                                                                                                                                                                                                                                                                                                                                                                           |
| Detector;RMS;                                                                                            |                                                                                                                                                                                                                                                                                                                                                                           |
| Sweep Count;0;                                                                                           |                                                                                                                                                                                                                                                                                                                                                                           |
| Trace 1;;                                                                                                |                                                                                                                                                                                                                                                                                                                                                                           |
| x-Unit;Hz;                                                                                               |                                                                                                                                                                                                                                                                                                                                                                           |
| y-Unit;dBm;                                                                                              |                                                                                                                                                                                                                                                                                                                                                                           |
| <b>List evaluation settings</b>                                                                          |                                                                                                                                                                                                                                                                                                                                                                           |
| Margin;200;                                                                                              | Peak List margin                                                                                                                                                                                                                                                                                                                                                          |
| <b>Reference range settings</b>                                                                          |                                                                                                                                                                                                                                                                                                                                                                           |
| RefType; CPOWER;                                                                                         | Reference power type                                                                                                                                                                                                                                                                                                                                                      |
| TxBandwidth;3840000;;Hz                                                                                  | Channel power settings                                                                                                                                                                                                                                                                                                                                                    |
| Filter State; ON;                                                                                        |                                                                                                                                                                                                                                                                                                                                                                           |
| Alpha;0.22;                                                                                              |                                                                                                                                                                                                                                                                                                                                                                           |
| PeaksPerRange;1;                                                                                         | Max. number of peaks per range to be detected                                                                                                                                                                                                                                                                                                                             |
| Values;2;                                                                                                | Number of detected peaks                                                                                                                                                                                                                                                                                                                                                  |
| <b>File data section</b>                                                                                 |                                                                                                                                                                                                                                                                                                                                                                           |
| 0;-12750000;-2515000;30000;13242367500;-43.844722747802734;-0.33028793334960938;49.669712066650391;FAIL; | Measured peak values:<br><range number>;<br><start frequency>;<br><stop frequency>;<br><resolution bandwidth of range>;<br><frequency of peak>;<br><absolute power in dBm of peak>;<br><relative power in dBc of peak>; (related to the channel power)<br><distance to the limit line in dB>; (positive value means above the limit)<br><limit fail (pass = 0, fail =1)>; |
| 2;2515000;12750000;30000;13257632500;-43.844722747802734;-0.33028793334960938;49.669712066650391;FAIL;   |                                                                                                                                                                                                                                                                                                                                                                           |

## 8.2.7 Spurious Emissions Measurement

Spurious Emissions measurements monitor unwanted RF products outside the assigned frequency band generated by an amplifier.

- About the Measurement.....335
- Spurious Emissions Measurement Results.....335
- Spurious Emissions Basics.....336
- Spurious Emissions Measurement Configuration.....338
- How to Perform a Spurious Emissions Measurement.....344
- Reference: ASCII Export File Format (Spurious).....346

### 8.2.7.1 About the Measurement

The Spurious Emissions measurement monitors unwanted RF products outside the assigned frequency band generated by an amplifier. The spurious emissions are usually measured across a wide frequency range. The Spurious Emissions measurement allows a flexible definition of all parameters. A result table indicates the largest deviations of the absolute power from the limit line for each range, and the results can be checked against defined limits automatically.

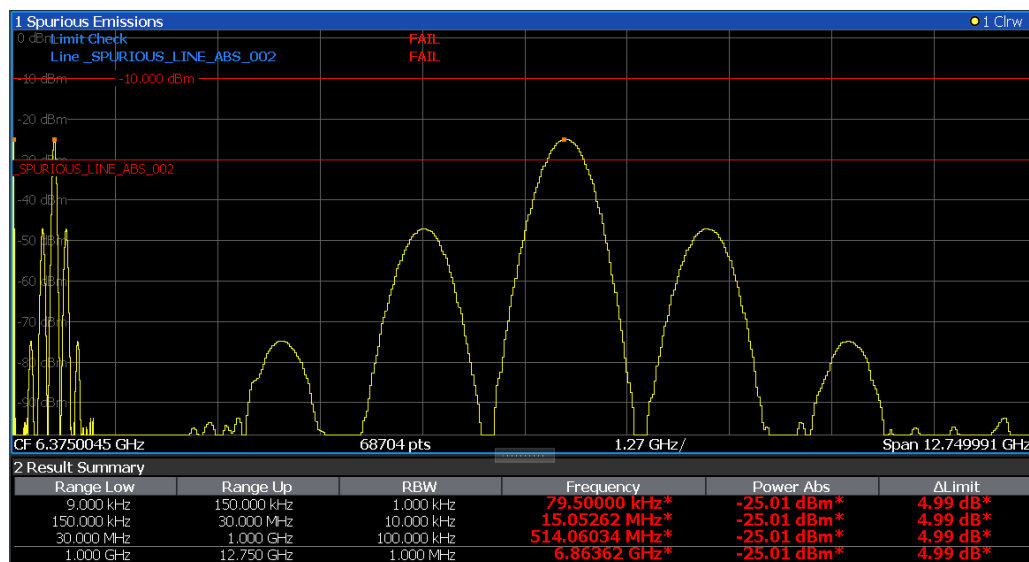

### 8.2.7.2 Spurious Emissions Measurement Results

The measured signal, including any spurious emissions, and optionally the detected peaks are displayed in the Spurious Emissions measurement diagram. If defined, the limit lines and the limit check results are also indicated. In addition to the graphical results, a result table can be displayed to evaluate the measured powers and limit check results (see also "Limit Lines in Spurious Measurements" on page 337). The details of the evaluation list can be configured.

| Range Low   | Range Up    | RBW         | Frequency      | Power Abs   | ΔLimit   |
|-------------|-------------|-------------|----------------|-------------|----------|
| 9,000 kHz   | 150,000 kHz | 1,000 kHz   | 79,50000 kHz*  | -25,01 dBm* | 4,99 dB* |
| 150,000 kHz | 30,000 MHz  | 10,000 kHz  | 15,05262 MHz*  | -25,01 dBm* | 4,99 dB* |
| 30,000 MHz  | 1,000 GHz   | 100,000 kHz | 514,06034 MHz* | -25,01 dBm* | 4,99 dB* |
| 1,000 GHz   | 12,750 GHz  | 1,000 MHz   | 6,86362 GHz*   | -25,01 dBm* | 4,99 dB* |

The following information is provided in the evaluation list for each range:

| Column    | Description                                                                     |
|-----------|---------------------------------------------------------------------------------|
| Range Low | Frequency range start for the range the peak value belongs to                   |
| Range Up  | Frequency range end for the range the peak value belongs to                     |
| RBW       | RBW of the range                                                                |
| Frequency | Frequency at the peak value                                                     |
| Power Abs | Absolute power level at the peak value                                          |
| ΔLimit    | Deviation of the absolute power level from the defined limit for the peak value |

By default, one peak per range is displayed. However, you can change the settings to:

- Display all peaks
- Display a certain number of peaks per range
- Display only peaks that exceed a threshold ( "Margin" )
- Display detected peaks as blue squares in the diagram, as well as in the peak list

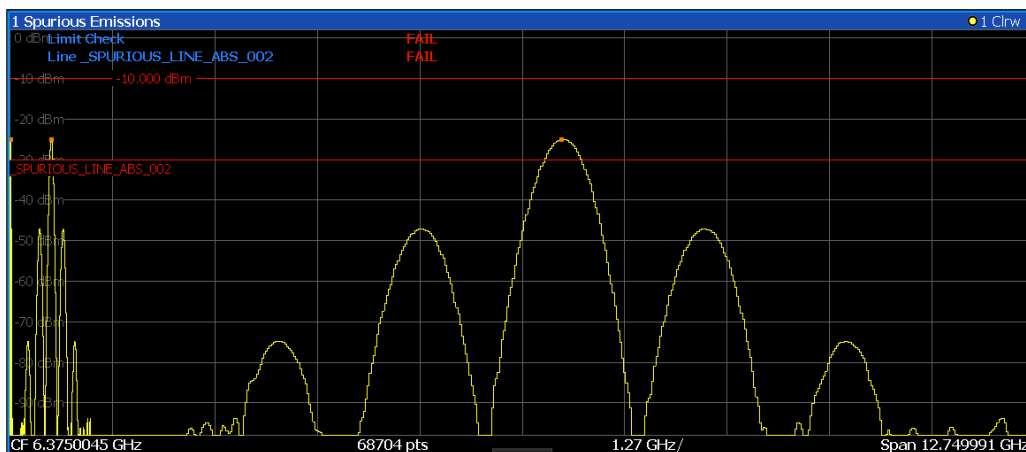

Furthermore, you can save the evaluation list to a file.

### Retrieving Results via Remote Control

The measured spurious values of the displayed trace can be retrieved using the TRAC:DATA? SPUR command (see TRACe<n> [:DATA] on page 776).

### 8.2.7.3 Spurious Emissions Basics

Some background knowledge on basic terms and principles used in Spurious Emissions measurements is provided here for a better understanding of the required configuration settings.

- [Ranges and Range Settings](#)..... 337
- [Limit Lines in Spurious Measurements](#)..... 337



## Ranges and Range Settings

### Conditions for ranges

The following rules apply to ranges:

- The minimum span of a range is 20 Hz.
- The individual ranges must not overlap (but can have gaps).
- The maximum number of ranges is 30
- The maximum number of sweep points in all ranges is limited to 100001.

You can define a span that is smaller than the combined span of the ranges. In this case, the measurement includes only the ranges that lie within the defined span and have a minimum span of 20 Hz.



### Defining ranges by remote control

In Spurious Emissions measurements, there are no remote commands to insert new ranges between existing ranges directly. However, you can delete or redefine the existing ranges to create the required order.

A remote command example for defining parameters and ranges in Spurious Emissions measurements is described in [Chapter 9.6.7.7, "Programming Example: Spurious Emissions Measurement"](#), on page 654.

---

### Limit Lines in Spurious Measurements

Limit lines allow you to check the measured data against specified limit values. Generally, it is possible to define limit lines for any measurement in the Spectrum application using the [Lines] key. For Spurious measurements, however, a special limit line is available via the "Sweep List", and it is strongly recommended that you use only this limit line definition.

In the "Sweep List", you can define a limit line that varies its level according to the specified frequency ranges. A distinguished limit line is automatically defined according to the current "Sweep List" settings every time the settings change. This limit line is labeled "\_SPURIOUS\_LINE\_ABS\_<xxx>", where <xxx> is an index to distinguish limit lines between different channel setups.

If a limit check is activated in the "Sweep List", the "\_SPURIOUS\_LINE\_ABS\_<xxx>" limit line is indicated by a red line in the display. The result of the limit check is indicated at the top of the diagram. Note that only "Pass" or "Fail" is indicated; a margin function as for general limit lines is not available. Also, only absolute limits can be checked, not relative ones.

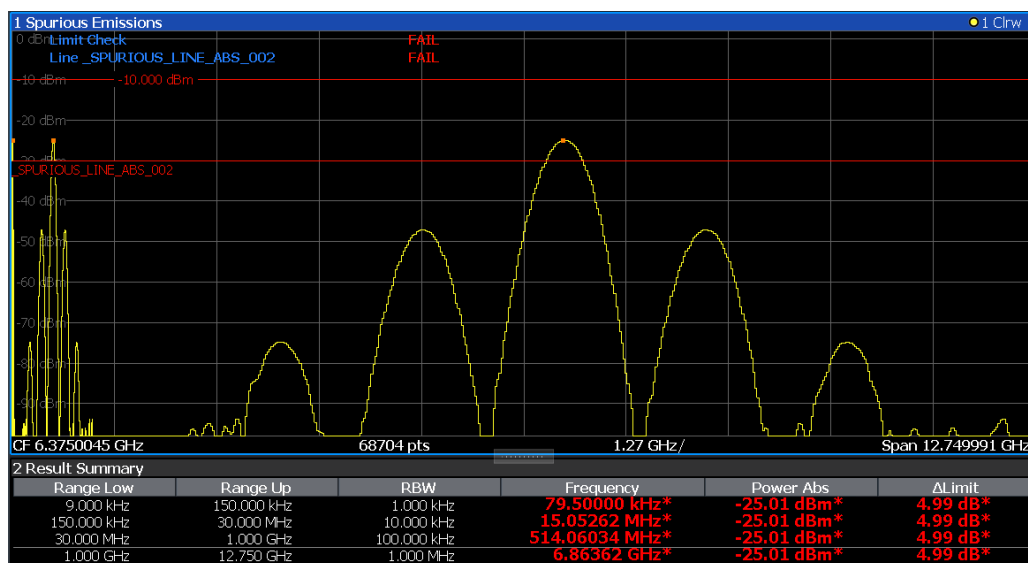

As for general limit lines, the results of each limit line check are displayed (here: "\_SPURIOUS\_LINE\_ABS\_<xxx>"), as well as the combined result for all defined limit lines ("Limit Check").

The limit check is considered to be "failed!" if any signal level outside the absolute limits is measured.

If the limit check is activated, the limit line values for each range are displayed in the evaluation list. Furthermore, the largest deviations of the absolute power from the limit line for each range are displayed. Values that exceed the limit are indicated in red and by an asterisk (\*).



Although a margin functionality is not available for the limit check, a margin (threshold) for the peak values to be displayed in the evaluation list can be defined. Furthermore, you can define how many peaks per range are listed. For details, see "List Evaluation" on page 343.

### 8.2.7.4 Spurious Emissions Measurement Configuration

**Access:** "Overview" > "Select Measurement" > "Spurious Emissions"

The spurious emissions measurement is started immediately with the default settings.

The remote commands required to perform these tasks are described in Chapter 9.6.7, "Measuring Spurious Emissions", on page 645.

- Sweep List.....339
- Adjusting the X-Axis to the Range Definitions.....342
- List Evaluation.....343

### Sweep List

**Access:** "Overview" > "Select Measurement" > "Spurious Emissions" > "Sweep List"

For Spurious Emissions measurements, the input signal is split into several frequency ranges which are swept individually and for which different limitations apply.



If you edit the sweep list, always follow the rules and consider the limitations described in "Ranges and Range Settings" on page 337.

| Spurious Emissions |             |             |             |             |
|--------------------|-------------|-------------|-------------|-------------|
|                    | Range 1     | Range 2     | Range 3     | Range 4     |
| Range Start        | 9 kHz       | 150 kHz     | 30 MHz      | 1 GHz       |
| Range Stop         | 150 kHz     | 30 MHz      | 1 GHz       | 12.75 GHz   |
| Filter Type        | Normal(3dB) | Normal(3dB) | Normal(3dB) | Normal(3dB) |
| RBW                | 1 kHz       | 10 kHz      | 100 kHz     | 1 MHz       |
| VBW                | 3 kHz       | 30 kHz      | 300 kHz     | 3 MHz       |
| Sweep Time Mode    | Auto        | Auto        | Auto        | Auto        |
| Sweep Time         | 14.1 ms     | 29.9 ms     | 32.1 ms     | 35.3 ms     |
| Detector           | RMS         | RMS         | RMS         | RMS         |
| Ref Level          | -10 dBm     | -10 dBm     | -10 dBm     | -10 dBm     |
| RF Att Mode        | Auto        | Auto        | Auto        | Auto        |
| RF Attenuation     | 0 dB        | 0 dB        | 0 dB        | 0 dB        |
| Preamp             | Off         | Off         | Off         | Off         |
| Sweep Points       | 701         | 4001        | 32001       | 32001       |
| Stop After Sweep   |             |             |             |             |
| Transducer         | None        | None        | None        | None        |
| Limit Check        | Absolute    | Absolute    | Absolute    | Absolute    |
| Abs Limit Start    | -30 dBm     | -30 dBm     | -30 dBm     | -30 dBm     |
| Abs Limit Stop     | -30 dBm     | -30 dBm     | -30 dBm     | -30 dBm     |

Insert before Range
Insert after Range
Delete Range
Adjust X-Axis

|                                |     |
|--------------------------------|-----|
| Range Start / Range Stop ..... | 340 |
| Filter Type .....              | 340 |
| RBW .....                      | 340 |
| VBW .....                      | 340 |
| Sweep Time Mode .....          | 340 |
| Sweep Time .....               | 340 |
| Detector .....                 | 341 |
| Reference Level .....          | 341 |
| RF Attenuation Mode .....      | 341 |
| RF Attenuation .....           | 341 |
| Preamp .....                   | 341 |
| Sweep Points.....              | 341 |
| Stop After Sweep .....         | 341 |
| Transducer .....               | 342 |
| Limit Check .....              | 342 |

|                                                |     |
|------------------------------------------------|-----|
| Abs Limit Start / Abs Limit Stop .....         | 342 |
| Insert before Range / Insert after Range ..... | 342 |
| Delete Range .....                             | 342 |

### Range Start / Range Stop

Sets the start frequency/stop frequency of the selected range.

You can define a span that is smaller than the overall span of the ranges. In this case, the measurement includes only the ranges that lie within the defined span and have a minimum span of 20 Hz.

Remote command:

`[SENSe:]LIST:RANGe<ri>[:FREQuency]:START` on page 622

`[SENSe:]LIST:RANGe<ri>[:FREQuency]:STOP` on page 623

### Filter Type

Sets the filter type for this range.

For details on filter types, see [Chapter 8.6.1.6, "Which Data May Pass: Filter Types"](#), on page 438.

Remote command:

`[SENSe:]LIST:RANGe<ri>:FILTer:TYPE` on page 647

### RBW

Sets the RBW value for this range.

For details on the RBW, see [Chapter 8.6.1.1, "Separating Signals by Selecting an Appropriate Resolution Bandwidth"](#), on page 435.

Remote command:

`[SENSe:]LIST:RANGe<ri>:BANDwidth:RESolution` on page 646

### VBW

Sets the VBW value for this range.

For details on the VBW, see [Chapter 8.6.1.2, "Smoothing the Trace Using the Video Bandwidth"](#), on page 436.

Remote command:

`[SENSe:]LIST:RANGe<ri>:BANDwidth:VIDeo` on page 646

### Sweep Time Mode

Activates or deactivates the auto mode for the sweep time.

For details on the sweep time mode, see [Chapter 8.6.1.7, "How Long the Data is Measured: Sweep Time"](#), on page 439

Remote command:

`[SENSe:]LIST:RANGe<ri>:SWEep:TIME:AUTO` on page 650

### Sweep Time

Sets the sweep time value for the range.

For details on the sweep time, see [Chapter 8.6.1.7, "How Long the Data is Measured: Sweep Time"](#), on page 439

Remote command:

[\[SENSe:\]LIST:RANGe<ri>:SWEep:TIME](#) on page 650

### Detector

Sets the detector for the range.

For details, refer to "[Mapping Samples to sweep Points with the Trace Detector](#)" on page 503.

Remote command:

[\[SENSe:\]LIST:RANGe<ri>:DETector](#) on page 647

### Reference Level

Sets the reference level for the range.

For details on the reference level, see [Chapter 8.5.1.1, "Reference Level"](#), on page 426.

Remote command:

[\[SENSe:\]LIST:RANGe<ri>:RLEVEL](#) on page 650

### RF Attenuation Mode

Activates or deactivates the auto mode for RF attenuation.

For details on attenuation, see [Chapter 8.5.1.2, "RF Attenuation"](#), on page 428.

Remote command:

[\[SENSe:\]LIST:RANGe<ri>:INPut:ATTenuation:AUTO](#) on page 648

### RF Attenuation

Sets the attenuation value for that range.

Remote command:

[\[SENSe:\]LIST:RANGe<ri>:INPut:ATTenuation](#) on page 648

### Preamp

Switches the preamplifier on or off.

For details on the preamplifier, see "[Preamplifier](#)" on page 432.

Remote command:

[\[SENSe:\]LIST:RANGe<ri>:INPut:GAIN:STATe](#) on page 648

### Sweep Points

Sets the number of sweep points for the specified range.

For details on sweep points, see [Chapter 8.6.1.8, "How Much Data is Measured: Sweep Points and Sweep Count"](#), on page 439.

Remote command:

[\[SENSe:\]LIST:RANGe<ri>:POINTs\[:VALue\]](#) on page 650

### Stop After Sweep

This function is not available for the R&S FPL1000.

**Transducer**

Sets a transducer for the specified range. You can only choose a transducer that fulfills the following conditions:

- The transducer overlaps or equals the span of the range.
- The x-axis is linear.
- The unit is dB.

For details on transducers, see [Chapter 7.3.6.1, "Basics on Transducer Factors"](#), on page 152.

Remote command:

[\[SENSe:\]LIST:RANGe<ri>:TRANsducer](#) on page 651

**Limit Check**

Activates or deactivates the limit check for all ranges.

For details on limit checks, see ["Limit Lines in Spurious Measurements"](#) on page 337.

"ABSOLUTE" Signal is checked against absolute limit values

"NONE" No limit check is performed.

Remote command:

[\[SENSe:\]LIST:RANGe<ri>:LIMit:STATe](#) on page 649

[CALCulate<n>:LIMit<li>:FAIL?](#) on page 858

**Abs Limit Start / Abs Limit Stop**

Sets an absolute limit value at the start or stop frequency of the range [dBm].

Remote command:

[\[SENSe:\]LIST:RANGe<ri>:LIMit:START](#) on page 649

[\[SENSe:\]LIST:RANGe<ri>:LIMit:STOP](#) on page 649

**Insert before Range / Insert after Range**

Inserts a new range to the left of the currently focused range (before) or to the right (after). The range numbers of the currently focused range and all higher ranges are increased accordingly. The maximum number of ranges is 30.

**Delete Range**

Deletes the currently focused range. The range numbers are updated accordingly.

**Adjusting the X-Axis to the Range Definitions**

**Access:** "Overview" > "Select Measurement" > "Spurious Emissions" > "Adjust X-Axis"

The frequency axis of the measurement diagram can be adjusted automatically so that the span of all sweep list ranges corresponds to the displayed span. Thus, the x-axis range is set from the start frequency of the first sweep range to the stop frequency of the last sweep range.

Remote command:

[\[SENSe:\]LIST:XADJust](#) on page 653

## List Evaluation

**Access:** "Overview" > "Select Measurement" > "Spurious Emissions" > "List Evaluation"

Configure the contents and display of the result list.

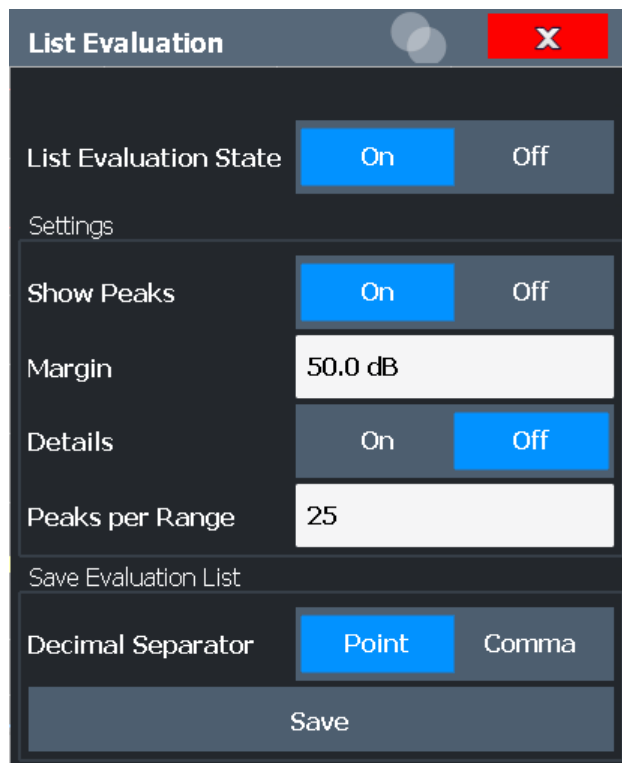

|                             |     |
|-----------------------------|-----|
| List Evaluation State ..... | 343 |
| Show Peaks .....            | 343 |
| Margin .....                | 344 |
| Details .....               | 344 |
| Peaks per Range .....       | 344 |
| Save Evaluation List .....  | 344 |

### List Evaluation State

Activates or deactivates the list evaluation.

Remote command:

[CALCulate<n>:ESpectrum:PEAKsearch:AUTO](#) on page 640

[TRACe<n>\[:DATA\]](#) on page 776

### Show Peaks

If activated, all peaks that have been detected during an active list evaluation are marked with blue squares in the diagram.

Remote command:

[CALCulate<n>:ESpectrum:PEAKsearch:PSHow](#) on page 641

**Margin**

A margin functionality is not available for the limit check. However, you can define a margin (=threshold) for the peak values to be displayed in the evaluation list. Only peaks that exceed the margin value are displayed (also in the diagram, if activated).

Remote command:

[CALCulate<n>:ESpectrum:PEAKsearch:MARGin](#) on page 641

**Details**

Configures how detailed the list in the Result Summary is.

|     |                                                                              |
|-----|------------------------------------------------------------------------------|
| On  | Includes all detected peaks (up to a maximum defined by "Peaks per Range" ). |
| Off | Includes only one peak per range.                                            |

Remote command:

[CALCulate<n>:ESpectrum:PEAKsearch:DETailS](#) on page 652

**Peaks per Range**

Defines the maximum number of peaks per range that are stored in the list. Once the selected number of peaks has been reached, the peak search is stopped in the current range and continued in the next range. The maximum value is 50.

Remote command:

[CALCulate<n>:PEAKsearch:SUBRanges](#) on page 653

**Save Evaluation List**

Exports the evaluation list of the Spurious Emissions measurement to an ASCII file for evaluation in an external application. If necessary, change the decimal separator for evaluation in other languages.

Define the file name and storage location in the file selection dialog box that is displayed when you select the "Save" function.

For details, see ["How to Save the Spurious Emissions Evaluation List"](#) on page 345.

Remote command:

[MMEMory:STORe<n>:LIST](#) on page 887

[FORMat:DEXPort:DSEParator](#) on page 863

**8.2.7.5 How to Perform a Spurious Emissions Measurement**

The following step-by-step instructions demonstrate how to perform spurious emissions measurements.



For remote operation, see [Chapter 9.6.7.7, "Programming Example: Spurious Emissions Measurement"](#), on page 654.

1. Press the [MEAS] key, then select the "Spurious Emissions" measurement.
2. Define the span of the signal to be monitored in the general span settings.
3. Select the "Overview" softkey, then select the "Spurious Setup" button.



The "Spurious Emissions" dialog box is displayed.

4. Split the frequency span of the measurement into ranges for signal parts with similar characteristics.  
Define the required ranges in the "Sweep List" using the "Insert before Range" and "Insert after Range" buttons, which refer to the currently selected range.
5. Define the measurement parameters for each range as required.
6. Optionally, define a limit check.
  - a) Activate the limit check by setting "Limit Check" to "ABSOLUTE" . The limit check is always activated or deactivated for all ranges simultaneously.
  - b) Define the limit line's start and stop values for each range of the signal. If a signal level higher than the defined limit is measured, the limit check fails, which may indicate a spurious emission.
7. Configure the peak detection during a Spurious Emissions measurement: select the "Evaluations" button in the "Overview" .
  - To indicate the determined peaks in the display, activate the "Show Peaks" option.
  - To restrict peak detection, define a "Margin" . Only peaks that exceed this value are detected.
  - To allow for more peaks per range to be detected than the default 1, increase the "Peaks per Range" value and set "Details" to "On" .
8. Start a sweep.  
The determined powers and limit deviations for each range are indicated in the evaluation list. If activated, the peak power levels for each range are also indicated in the diagram.
9. To save the evaluation list, export the results to a file as described in ["How to Save the Spurious Emissions Evaluation List"](#) on page 345.

#### How to Save the Spurious Emissions Evaluation List

The evaluation list from a Spurious Emissions measurement can be saved to a file, which can be exported to another application for further analysis, for example.

1. Configure and perform a Spurious Emissions measurement as described in [Chapter 8.2.7.5, "How to Perform a Spurious Emissions Measurement"](#), on page 344.
2. Select the "Evaluations" button in the "Overview" .
3. If necessary, change the "Decimal Separator" to "COMMA" for evaluation in other languages.
4. Select the "Save" button.
5. In the file selection dialog box, select a storage location and file name for the result file.

## 6. Select the "Save" button.

The file with the specified name and the extension `.dat` is stored in the defined storage location.

### 8.2.7.6 Reference: ASCII Export File Format (Spurious)

The file has a header containing important parameters for scaling, several data sections containing the sweep settings per range, and a data section containing the peak list.

The header data is made up of three columns, separated by ';', with the syntax:

Parameter name; numeric value; basic unit

| File contents                    | Explanation                             |
|----------------------------------|-----------------------------------------|
| <b>File header</b>               |                                         |
| Type;FPL1003                     | Model                                   |
| Version;1.00;                    | Firmware version                        |
| Date;31.Mar 11;                  | Storage date of data set                |
| Mode;ANALYZER; SPURIOUS;         | Operating mode and measurement function |
| Center Freq;1325000000.000000;Hz | X-axis settings                         |
| Freq Offset;0.000000;Hz          |                                         |
| Span;26499982000.000000;Hz       |                                         |
| x-Axis;LIN;                      |                                         |
| Start;9000.000000;Hz             |                                         |
| Stop;8000000000.000000;Hz        |                                         |
| Level Offset;0.000000;dB         | Y-axis settings                         |
| Ref Position;100.000000;%        |                                         |
| y-Axis;LOG;                      |                                         |
| Level Range;100.000000;dB        |                                         |
| <b>Trace settings</b>            |                                         |
| Trace Mode;CLR/WRITE;            |                                         |
| Sweep Count;1;                   |                                         |
| TRACE 1:                         |                                         |
| Trace Mode;CLR/WRITE;            |                                         |
| x-Unit;Hz;                       |                                         |
| y-Unit;dBm;                      |                                         |
| <b>List evaluation settings</b>  |                                         |
| Margin;6.000000;s                | Peak List margin                        |

| File contents                                                                       | Explanation                                                                                                                                                                                                                                                                                            |
|-------------------------------------------------------------------------------------|--------------------------------------------------------------------------------------------------------------------------------------------------------------------------------------------------------------------------------------------------------------------------------------------------------|
| PeaksPerRange;25;                                                                   | Max. number of peaks per range to be detected                                                                                                                                                                                                                                                          |
| Values;3;                                                                           | Number of detected peaks                                                                                                                                                                                                                                                                               |
| <b>File data section</b>                                                            |                                                                                                                                                                                                                                                                                                        |
| 0;9000;150000;1000;79500;-25.006643295288086;-12.006643295288086;PASS;              | Measured peak values:<br><range number>;<br><start frequency>;<br><stop frequency>;<br><resolution bandwidth of range>;<br><frequency of peak>;<br><absolute power in dBm of peak>;<br><distance to the limit line in dB>; (positive value means above the limit)<br><limit fail (pass = 0, fail =1)>; |
| 0;9000;150000;1000;101022.11126961483;-47.075111389160156;-34.075111389160156;PASS; |                                                                                                                                                                                                                                                                                                        |
| 0;9000;150000;1000;58380.171184022824;-47.079341888427734;-34.079341888427734;PASS; |                                                                                                                                                                                                                                                                                                        |
|                                                                                     |                                                                                                                                                                                                                                                                                                        |

## 8.2.8 Statistical Measurements (APD, CCDF)

To measure the amplitude distribution, the R&S FPL1000 has simple measurement functions to determine both the Amplitude Probability Distribution (APD) and the Complementary Cumulative Distribution Function (CCDF). Only one of the signal statistic functions can be switched on at a time.

- [About the Measurements](#)..... 347
- [Typical Applications](#)..... 348
- [APD and CCDF Results](#)..... 348
- [APD and CCDF Basics - Gated Triggering](#)..... 350
- [APD and CCDF Configuration](#)..... 351
- [How to Perform an APD or CCDF Measurement](#)..... 357
- [Examples](#)..... 358
- [Optimizing and Troubleshooting the Measurement](#)..... 361

### 8.2.8.1 About the Measurements

The probability of amplitude values can be measured with the Amplitude Probability Distribution function (APD). During a selectable measurement time all occurring amplitude values are assigned to an amplitude range. The number of amplitude values in the individual ranges is counted and the result is displayed as a histogram.

Alternatively, the Complementary Cumulative Distribution Function (CCDF) can be displayed. It shows the probability that the mean signal power amplitude will be exceeded in percent.

Only one of the signal statistic functions can be switched on at a time. When a statistic function is switched on, the R&S FPL1000 is set into zero span mode automatically. The R&S FPL1000 measures the statistics of the signal applied to the RF input with the defined analysis bandwidth. To avoid affecting the peak amplitudes the video band-

width is automatically set to 10 times the analysis bandwidth. The sample detector is used for detecting the video voltage.

Statistic measurements on pulsed signals can be performed using a gated trigger. For details see [Chapter 8.2.8.4, "APD and CCDF Basics - Gated Triggering"](#), on page 350.

### 8.2.8.2 Typical Applications

Digital modulated signals are similar to white noise within the transmit channel, but are different in their amplitude distribution. In order to transmit the modulated signal without distortion, all amplitudes of the signal have to be transmitted linearly from the output power amplifier. Most critical are the peak amplitude values. Degradation in transmit quality caused by a transmitter two port network is dependent on the amplitude of the peak values as well as on their probability.

If modulation types are used that do not have a constant envelope in zero span, the transmitter has to handle peak amplitudes that are greater than the average power. This includes all modulation types that involve amplitude modulation, QPSK for example. CDMA transmission modes in particular may have power peaks that are large compared to the average power.

For signals of this kind, the transmitter must provide large reserves for the peak power to prevent signal compression and thus an increase of the bit error rate at the receiver. The peak power or the crest factor of a signal is therefore an important transmitter design criterion. The crest factor is defined as the peak power to mean power ratio or, logarithmically, as the peak level minus the average level of the signal. To reduce power consumption and cut costs, transmitters are not designed for the largest power that could ever occur, but for a power that has a specified probability of being exceeded (e.g. 0.01 %).

The statistical functions provide information on such signal criteria.

### 8.2.8.3 APD and CCDF Results

#### Amplitude Probability Distribution (APD)

As a result of the Amplitude Probability Distribution (APD) function, the probability of measured amplitude values is displayed. During a selectable measurement time all measured amplitude values are assigned to an amplitude range (*bin*). The number of amplitude values in the individual ranges is counted and the result is displayed as a histogram. Each bar of the histogram represents the percentage of measured amplitudes within the specific amplitude range. The x-axis represents the amplitude values and is scaled in absolute values (dBm).



The size of each amplitude range (bin) determines the resolution of the histogram and is indicated in the channel bar, for example  $/ 0.10 \text{ dB}$ . In this case, a single bar in the histogram represents an amplitude range of 0.10 dB.

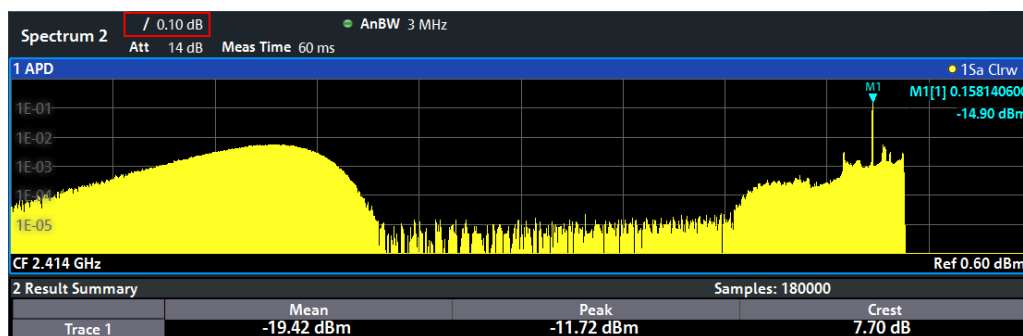

In addition to the histogram, a result table is displayed containing the following information:

- Number of samples used for calculation
- For each displayed trace:
  - Mean amplitude
  - Peak amplitude
  - Crest factor

The crest factor is defined as the peak power to mean power ratio or, logarithmically, as the peak level minus the average level of the signal.

### Complementary Cumulative Distribution Function (CCDF)

The Complementary Cumulative Distribution Function (CCDF) shows the probability that the mean signal power amplitude will be exceeded in percent. The level above the mean power is plotted along the x-axis of the graph. The origin of the axis corresponds to the mean power level. The probability that a level will be exceeded is plotted along the y-axis.

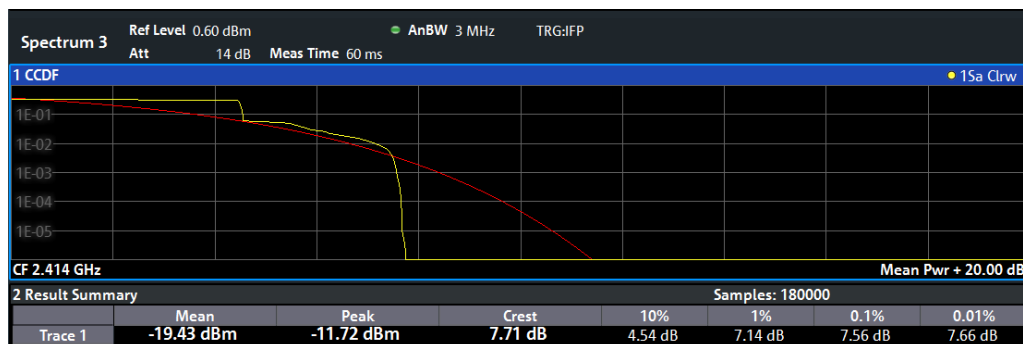

A red line indicates the ideal Gaussian distribution for the measured amplitude range.

The displayed amplitude range is indicated as "Mean Pwr" + "<x dB>"

In addition to the histogram, a result table is displayed containing the following information:

- Number of samples used for calculation

- For each displayed trace:

|               |                                           |
|---------------|-------------------------------------------|
| Mean          | Mean power                                |
| <b>Peak</b>   | Peak power                                |
| <b>Crest</b>  | Crest factor (peak power – mean power)    |
| <b>10 %</b>   | Level values over 10 % above mean power   |
| <b>1 %</b>    | Level values over 1 % above mean power    |
| <b>0,1 %</b>  | Level values over 0,1 % above mean power  |
| <b>0,01 %</b> | Level values over 0,01 % above mean power |

### Percent marker

In addition to the results for specific percentages in the table, a percent marker can be activated for a freely selectable percentage. This marker indicates how many level values are over <x> % above the mean power.



### Percent marker

As all markers, the percent marker can be moved simply by selecting it with a finger or mouse cursor and dragging it to the desired position.

### Diagram Scaling

The scaling for both the x-axis and y-axis of the statistics diagram can be configured. In particular, you can restrict the range of amplitudes to be evaluated and the probabilities to be displayed.

### Remote commands:

`CALCulate<n>:STATistics:CCDF:X<t>?` on page 663

`CALCulate<n>:STATistics:RESult<res>?` on page 663

## 8.2.8.4 APD and CCDF Basics - Gated Triggering

Statistic measurements on pulsed signals can be performed using a gated trigger. An external frame trigger is required as a time (frame) reference.

The gate ranges define the part of the measured data taken into account for the statistics calculation. These ranges are defined relative to a reference point T=0. The gate interval is repeated for each period until the end of the capture buffer.

The reference point T=0 is defined by the external trigger event and the instrument's trigger offset.

For each trace you can define up to 3 separate ranges of a single period to be traced.

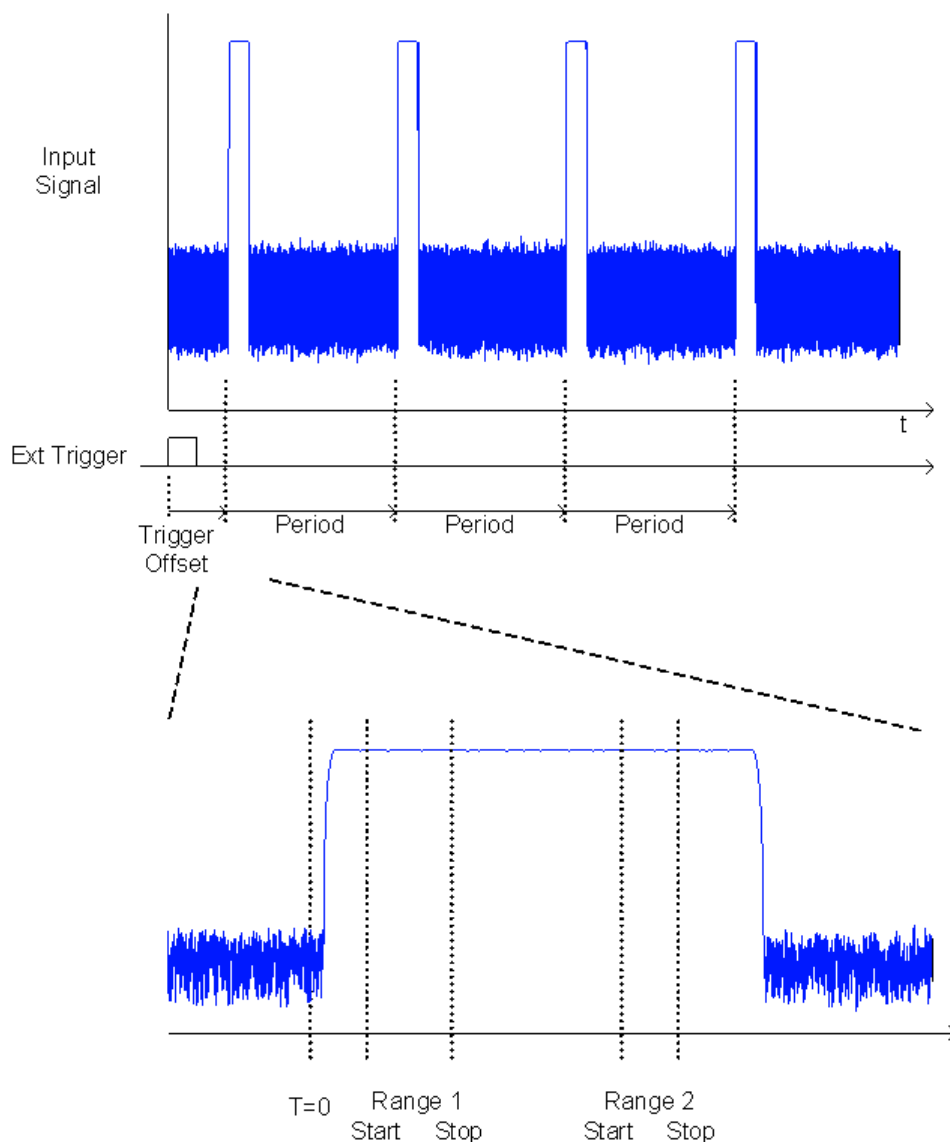

### 8.2.8.5 APD and CCDF Configuration

Configuration consists of the following settings:

- Make sure the specified reference level is higher than the measured peak value (see "Reference Level" on page 429).
- [Basic Settings](#)..... 351
- [Gate Range Definition for APD and CCDF](#)..... 353
- [Scaling for Statistics Diagrams](#)..... 355

#### Basic Settings

**Access:** "Overview" > "Select Measurement" > "APD" / "CCDF" > "APD Config" / "CCDF Config"

The remote commands required to perform these tasks are described in [Chapter 9.6.8, "Analyzing Statistics \(APD, CCDF\)"](#), on page 656.

| CCDF               |                                                               |
|--------------------|---------------------------------------------------------------|
| Percent Marker     | 0.0 %                                                         |
| Analysis Bandwidth | 3.0 MHz                                                       |
| Number of Samples  | 100000                                                        |
| Gated Trigger      | On <input type="radio"/> Off <input checked="" type="radio"/> |
| Edit Gate Ranges   |                                                               |
| Adjust Settings    |                                                               |

Both dialog boxes are identical except for the "Percent Marker" setting, which is only available for CCDF measurements.

|                                                  |     |
|--------------------------------------------------|-----|
| <a href="#">Percent Marker (CCDF only)</a> ..... | 352 |
| <a href="#">Analysis Bandwidth</a> .....         | 352 |
| <a href="#">Number of Samples</a> .....          | 352 |
| <a href="#">Gated Trigger</a> .....              | 353 |
| <a href="#">Edit Gate Ranges</a> .....           | 353 |
| <a href="#">Adjust Settings</a> .....            | 353 |

#### Percent Marker (CCDF only)

Defines a probability value. Thus, the power which is exceeded with a given probability can be determined very easily. If marker 1 is deactivated, it is switched on automatically.

Remote command:

`CALCulate<n>:MARKer<m>:Y:PERCent` on page 657

#### Analysis Bandwidth

Defines the analysis bandwidth.

For correct measurement of the signal statistics, the analysis bandwidth has to be wider than the signal bandwidth in order to measure the peaks of the signal amplitude correctly. To avoid influencing the peak amplitudes, the video bandwidth is automatically set to 10 MHz. The sample detector is used for detecting the video voltage.

The calculated measurement time is displayed for reference only.

Remote command:

`[SENSe:]BANDwidth[:RESolution]` on page 722

#### Number of Samples

Defines the number of power measurements that are taken into account for the statistics.



For statistics measurements with the R&S FPL1000, the number of samples to be measured is defined instead of the sweep time. Since only statistically independent samples contribute to statistics, the sweep or measurement time is calculated automatically and displayed in the channel bar ( "Meas Time" ). The samples are statistically independent if the time difference is at least 1/RBW. The measurement time is, therefore, expressed as follows:

$$\text{Meas Time} = N_{\text{Samples}}/\text{RBW}$$

For the R&S FPL1000, the maximum number of samples is approximately 20 million.

Remote command:

`CALCulate<n>:STATistics:NSAMples` on page 657

### Gated Trigger

Activates and deactivates gating for statistics functions for the ACP and the CCDF measurements. If activated, the trigger source is changed to "External Trigger 1" . The gate ranges are defined using the [Edit Gate Ranges](#) function.

Remote command:

`[SENSe:]SWEep:EGATe:TRACe<t>[:STATe<gr>]` on page 659

### Edit Gate Ranges

Opens a dialog box to configure up to 3 gate ranges for each trace. For details see ["Gate Range Definition for APD and CCDF"](#) on page 353.

### Adjust Settings

Adjusts the level settings according to the measured difference between peak and minimum power for APD measurement or peak and mean power for CCDF measurement in order to obtain maximum power resolution. Adjusts the reference level to the current input signal.

Remote command:

`CALCulate<n>:STATistics:SCALE:AUTO ONCE` on page 660

### Gate Range Definition for APD and CCDF

**Access:** "Overview" > "Select Measurement" > "APD" / "CCDF" > "APD Config" / "CCDF Config" > "Edit Gate Ranges"

You can configure gate ranges for gated triggering in statistical measurements.

For background information on defining gate ranges see [Chapter 8.2.8.4, "APD and CCDF Basics - Gated Triggering"](#), on page 350.

The remote commands required to perform these tasks are described in [Chapter 9.6.8.3, "Using Gate Ranges for Statistical Measurements"](#), on page 658.

| Gate Ranges   |         |         |         |         |         |         |
|---------------|---------|---------|---------|---------|---------|---------|
|               | Trace 1 | Trace 2 | Trace 3 | Trace 4 | Trace 5 | Trace 6 |
| Comment       |         |         |         |         |         |         |
| Period        | 2 ms    | 2 ms    | 2 ms    | 2 ms    | 2 ms    | 2 ms    |
| Range 1 Use   | On      | Off     | Off     | Off     | Off     | Off     |
| Range 1 Start | 0 s     | 0 s     | 0 s     | 0 s     | 0 s     | 0 s     |
| Range 1 Stop  | 1 ms    | 1 ms    | 1 ms    | 1 ms    | 1 ms    | 1 ms    |
| Range 2 Use   | Off     | Off     | Off     | Off     | Off     | Off     |
| Range 2 Start | 2 ms    | 2 ms    | 2 ms    | 2 ms    | 2 ms    | 2 ms    |
| Range 2 Stop  | 3 ms    | 3 ms    | 3 ms    | 3 ms    | 3 ms    | 3 ms    |
| Range 3 Use   | Off     | Off     | Off     | Off     | Off     | Off     |
| Range 3 Start | 4 ms    | 4 ms    | 4 ms    | 4 ms    | 4 ms    | 4 ms    |
| Range 3 Stop  | 5 ms    | 5 ms    | 5 ms    | 5 ms    | 5 ms    | 5 ms    |

Up to three ranges can be defined for each of the six available traces.

Comment .....354  
 Period ..... 354  
 Range <x> Use ..... 354  
 Range <x> Start/Stop .....354

**Comment**

An optional comment can be defined for the gate range settings of each trace.

Remote command:

[SENSe:] SWEep:EGATe:TRACe<t>:COMMeNt on page 658

**Period**

Length of the period to be traced. The period is the same for all traces. If you change the period for one trace, it is automatically changed for all traces.

Make sure the defined period is not longer than the total measurement time of the current measurement. Keep in mind that the measurement time depends on the bandwidth and the number of samples (see " Number of Samples " on page 352). The current measurement time is indicated as "Meas Time" in the channel bar.

Remote command:

[SENSe:] SWEep:EGATe:TRACe<t>:PERIoD on page 658

**Range <x> Use**

Activates tracing of the defined range during a gated measurement.

Remote command:

[SENSe:] SWEep:EGATe:TRACe<t>[:STATe<gr>] on page 659

**Range <x> Start/Stop**

Defines the start and stop points of the range within the tracing period. Make sure the value for the stopping time is smaller than the length of the period.

**Note:** You can define the time values with a greater numerical resolution than is displayed; the values are only rounded for display.

Remote command:

[SENSe:] SWEep:EGATe:TRACe<t>:STARt<gr> on page 658

[SENSe:] SWEep:EGATe:TRACe<t>:STOP<gr> on page 659

**Scaling for Statistics Diagrams**

**Access:** "Overview" > "Amplitude" > "Scale" tab

**Or:** [AMPT] > "Scale Config"

For statistics displays, scale settings are available for both the y-axis and the x-axis.

The remote commands required to perform these tasks are described in [Chapter 9.6.8.4, "Scaling the Diagram"](#), on page 660.

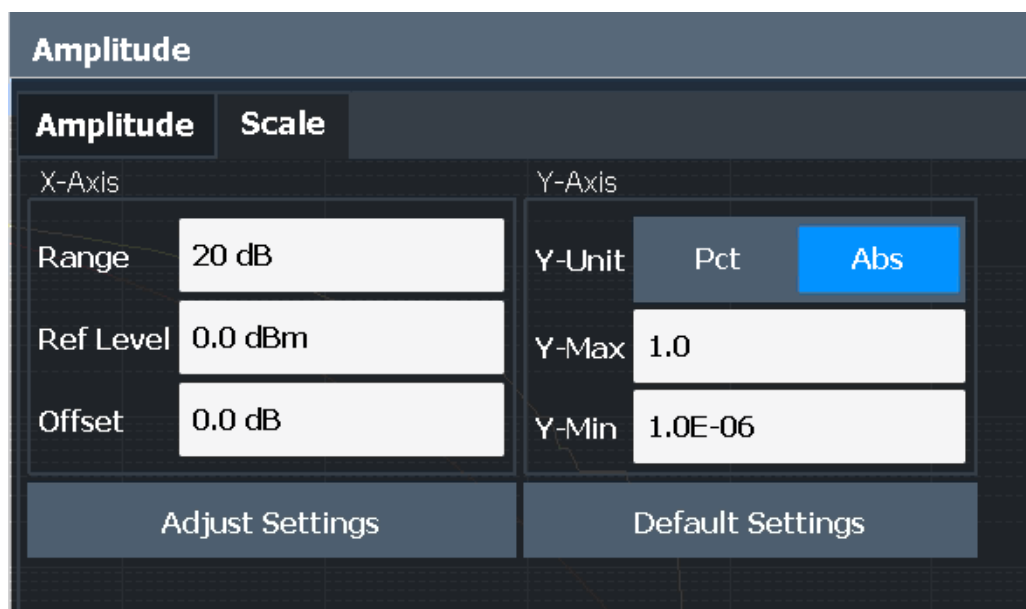

Figure 8-29: Scale settings for CCDF diagram



In statistical diagrams, the x-axis displays the signal level values (= y-axis in standard display), while the y-axis displays the probability of the values.

X-Axis ..... 356  
 L Ref Level ..... 356  
 L Range ..... 356  
 L Shifting the Display ( Offset ) ..... 356  
 Y-Axis ..... 356  
 L Y-Unit ..... 356  
 L Y-Max / Y-Min ..... 356  
 Default Settings ..... 356  
 Adjust Settings ..... 357

**X-Axis**

Defines the scaling settings for signal level values.

**Ref Level ← X-Axis**

Defines the reference level for the signal levels in the currently active unit (dBm, dBμV, etc.).

For the APD function this value corresponds to the right diagram border. For the CCDF function there is no direct representation of this value on the diagram as the x-axis is scaled relatively to the measured mean power.

Remote command:

[CALCulate<n>:STATistics:SCALE:X:RLEVel](#) on page 661

**Range ← X-Axis**

Defines the level range in dB to be evaluated by the statistics measurement.

Remote command:

[CALCulate<n>:STATistics:SCALE:X:RANGE](#) on page 661

**Shifting the Display ( Offset ) ← X-Axis**

Defines an arithmetic level offset. This offset is added to the measured level irrespective of the selected unit. The scaling of the x-axis is changed accordingly. The setting range is ±200 dB in 0.1 dB steps.

Remote command:

[DISPlay\[:WINDow<n>\]:TRACe<t>:Y\[:SCALE\]:RLEVel:OFFSet](#) on page 730

**Y-Axis**

Defines the scaling settings for the probability distribution.

**Y-Unit ← Y-Axis**

Defines the scaling type of the y-axis as either percentage or absolute. The default value is absolute scaling.

Remote command:

[CALCulate<n>:STATistics:SCALE:Y:UNIT](#) on page 662

**Y-Max / Y-Min ← Y-Axis**

Defines the upper (max) and lower (min) limit of the displayed probability range. Values on the y-axis are normalized which means that the maximum value is 1.0. The minimum value must be in the range:

$1E-9 < Y-Min < 0.1$

The distance between "Y-Max" and "Y-Min" must be at least one decade.

Remote command:

[CALCulate<n>:STATistics:SCALE:Y:UPPer](#) on page 662

[CALCulate<n>:STATistics:SCALE:Y:LOWer](#) on page 661

**Default Settings**

Resets the x- and y-axis scalings to their preset values.

|                     |         |
|---------------------|---------|
| X-axis ref level:   | -10 dBm |
| X-axis range APD:   | 100 dB  |
| X-axis range CCDF:  | 20 dB   |
| Y-axis upper limit: | 1.0     |
| Y-axis lower limit: | 1E-6    |

Remote command:

[CALCulate<n>:STATistics:PRESet](#) on page 660

### Adjust Settings

Adjusts the level settings according to the measured difference between peak and minimum power for APD measurement or peak and mean power for CCDF measurement in order to obtain maximum power resolution. Adjusts the reference level to the current input signal.

Remote command:

[CALCulate<n>:STATistics:SCALE:AUTo](#) ONCE on page 660

#### 8.2.8.6 How to Perform an APD or CCDF Measurement

The following step-by-step instructions demonstrate how to perform basic statistic measurements.



For remote operation, see [Chapter 9.6.8.7, "Programming Example: Measuring Statistics"](#), on page 664.

#### To start a basic statistic measurement

1. Press the [MEAS] key, then select the "APD" or "CCDF" measurement.
2. Start a sweep.

As soon as the defined number of samples have been measured, the statistical evaluation is displayed.

#### To perform a statistic measurement using gate ranges

For pulsed signals, the transmission intervals should not be included in the statistical evaluation. Thus, you must define gate ranges to be included in the measurement.

1. Press the [MEAS Config] key, then select the "APD Config" or "CCDF Config" soft-key.  
The "APD" "APD" or "CCDF" dialog box is displayed.
2. Select the "Edit Gate Ranges" button.
3. Define the time period for which the input signal is to be analyzed, for example the duration of 3 signal pulses.

4. For each active trace, define up to three ranges within the time period to be measured. In the example covering 3 pulses, you could define one range for each pulse.
  - a) Assuming the external trigger determines  $T=0$  as the start of the first pulse, define the start time of range 1 at 0 s.
  - b) Define the stop time of range 1 at the duration of the first pulse.
  - c) Activate range 1 by setting "Range 1 Use" to *On*.
  - d) Define the start time of range 2 as (duration of pulse 1 + duration of interval)
  - e) Define the stop time of range 2 as (start time of range 2 + duration of pulse 2)
  - f) Activate range 2 by setting "Range 2 Use" to *On*.
  - g) Define the third range in the same way.
5. Start a sweep.

As soon as the defined number of samples have been measured, the statistical evaluation is displayed. Only the signal levels within the pulse periods are considered.

### 8.2.8.7 Examples

#### Configuration Example: Gated Statistics

A statistics evaluation has to be done over the useful part of the signal between  $t_3$  and  $t_4$ . The period of the GSM signal is 4.61536 ms.

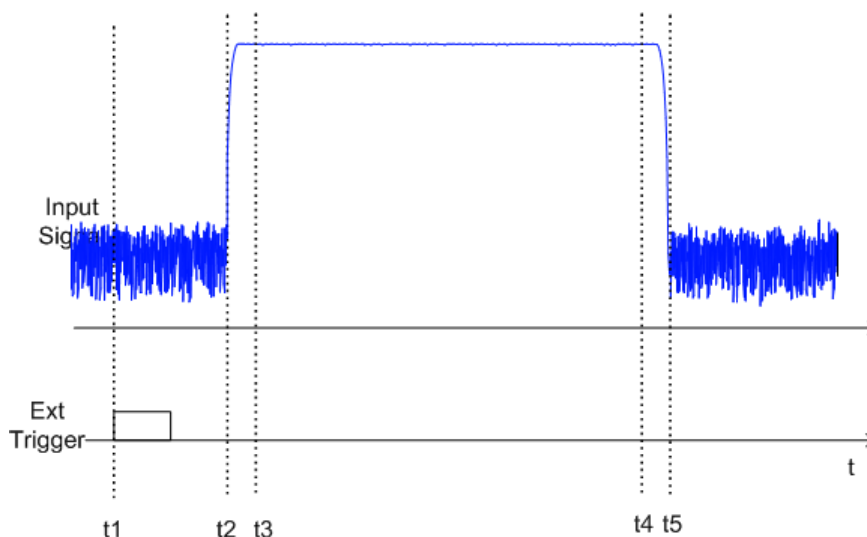

- $t_1$ : External positive trigger slope
- $t_2$ : Begin of burst (after 25  $\mu$ s)
- $t_3$ : Begin of useful part, to be used for statistics (after 40  $\mu$ s)
- $t_4$ : End of useful part, to be used for statistics (after 578  $\mu$ s)
- $t_5$ : End of burst (after 602  $\mu$ s)

The instrument has to be configured as follows:

|                |                               |                                           |
|----------------|-------------------------------|-------------------------------------------|
| Trigger Offset | $t_2 - t_1 = 25 \mu\text{s}$  | now the gate ranges are relative to $t_2$ |
| Range1 Start   | $t_3 - t_2 = 15 \mu\text{s}$  | start of range 1 relative to $t_2$        |
| Range1 End     | $t_4 - t_2 = 553 \mu\text{s}$ | end of range 1 relative to $t_2$          |

### Measurement Example – Measuring the APD and CCDF of White Noise Generated by the R&S FPL1000



#### Setting the analysis bandwidth

When the amplitude distribution is measured, the analysis bandwidth must be set so that the complete spectrum of the signal to be measured falls within the bandwidth. This is the only way of ensuring that all the amplitudes will pass through the IF filter without being distorted. If the selected bandwidth is too small for a digitally modulated signal, the amplitude distribution at the output of the IF filter becomes a Gaussian distribution according to the central limit theorem and thus corresponds to a white noise signal. The true amplitude distribution of the signal therefore cannot be determined.



A programming example demonstrating a statistics measurement in a remote environment is provided in [Chapter 9.6.8.7, "Programming Example: Measuring Statistics"](#), on page 664.

1. Preset the R&S FPL1000.
2. Set the reference level to  $-60 \text{ dBm}$ .  
The R&S FPL1000's intrinsic noise is displayed at the top of the screen.
3. Select the "APD" measurement function from the "Select Measurement" dialog box.  
The R&S FPL1000 sets the frequency span to 0 Hz and measures the amplitude probability distribution (APD). The number of uncorrelated level measurements used for the measurement is 100000. The mean power and the peak power are displayed in dBm. The crest factor (peak power – mean power) is output as well.

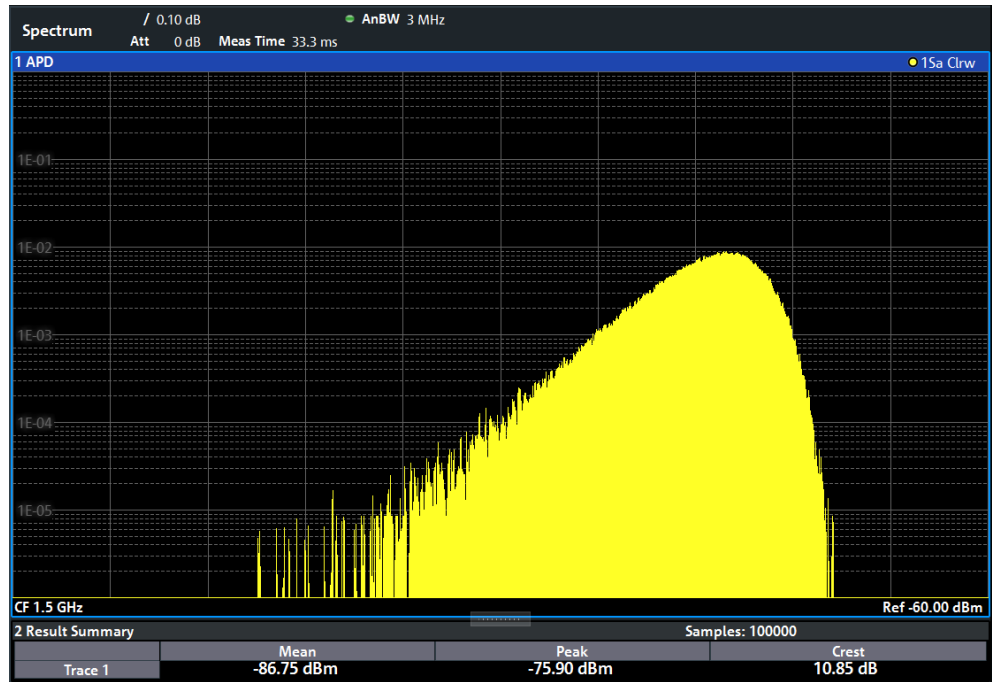

Figure 8-30: Amplitude probability distribution of white noise

- Now select the "CCDF" measurement function from the "Select Measurement" dialog box.

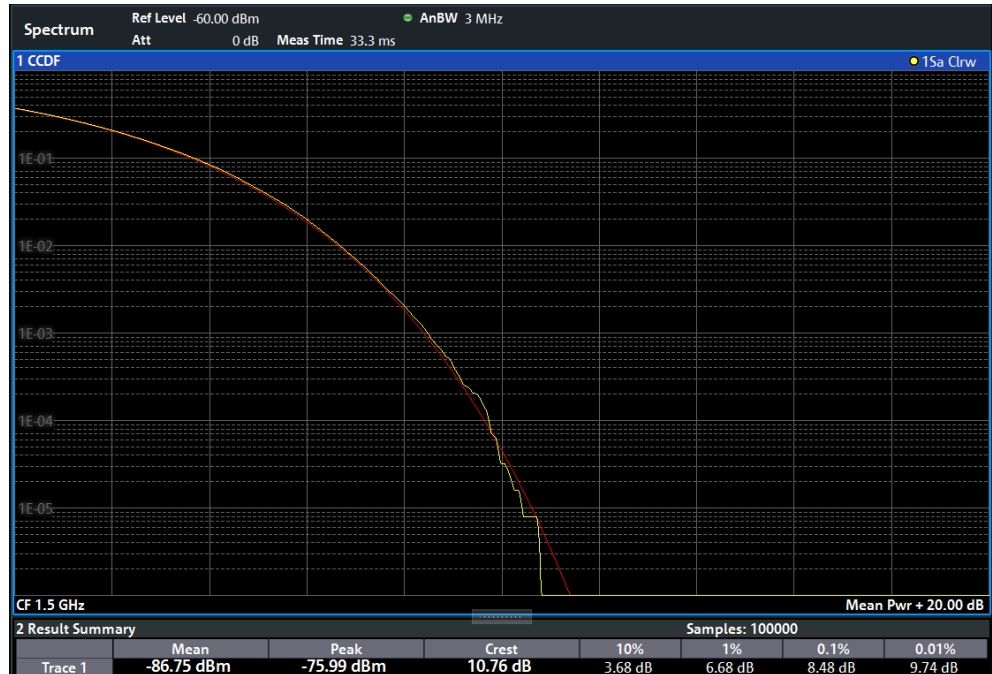

Figure 8-31: CCDF of white noise



The CCDF trace indicates the probability that a level will exceed the mean power. The level above the mean power is plotted along the x-axis of the graph. The origin of the axis corresponds to the mean power level. The probability that a level will be exceeded is plotted along the y-axis.

### 8.2.8.8 Optimizing and Troubleshooting the Measurement

If the results do not meet your expectations, try the following methods to optimize the measurement:

- Make sure the defined bandwidth is wide enough for the signal bandwidth of the device under test to be fully analyzed (see " [Analysis Bandwidth](#) " on page 352).
- If the complete signal is to be measured, increase the number of samples so that the resulting measurement time is longer than one period of a bursted signal.
- If only parts of the signal are to be examined, define a trigger source and a gate.

## 8.2.9 Time Domain Power Measurement

The Time Domain Power measurement determines the power of a signal in the time domain.

A time domain power measurement is only possible for zero span.

- [About the Measurement](#).....361
- [Time Domain Power Results](#).....361
- [Time Domain Power Basics - Range Definition Using Limit Lines](#).....362
- [Time Domain Power Configuration](#).....363
- [How to Measure Powers in the Time Domain](#).....364
- [Measurement Example](#).....365

### 8.2.9.1 About the Measurement

Using the Time Domain Power measurement function, the R&S FPL1000 determines the power of the signal in zero span by summing up the power at the individual measurement points and dividing the result by the number of measurement points. Thus it is possible to measure the power of TDMA signals during transmission, for example, or during the muting phase. Both the mean power and the RMS power can be measured.

For this measurement, the sample detector is activated.

### 8.2.9.2 Time Domain Power Results

Several different power results can be determined simultaneously:

| Mode    | Description                                                                                                                                                                                         |
|---------|-----------------------------------------------------------------------------------------------------------------------------------------------------------------------------------------------------|
| Peak    | Peak value from the points of the displayed trace or a segment thereof.                                                                                                                             |
| RMS     | RMS value from the points of the displayed trace or a segment thereof.                                                                                                                              |
| Mean    | Mean value from the points of the displayed trace or a segment thereof. The linear mean value of the equivalent voltages is calculated.<br>For example to measure the mean power during a GSM burst |
| Std Dev | The standard deviation of the measurement points from the mean value.                                                                                                                               |

The result is displayed in the marker results, indicated by "Power" and the selected power mode, e.g. "RMS". The measured values are updated after each sweep or averaged over a user-defined number of sweeps (trace averaging).

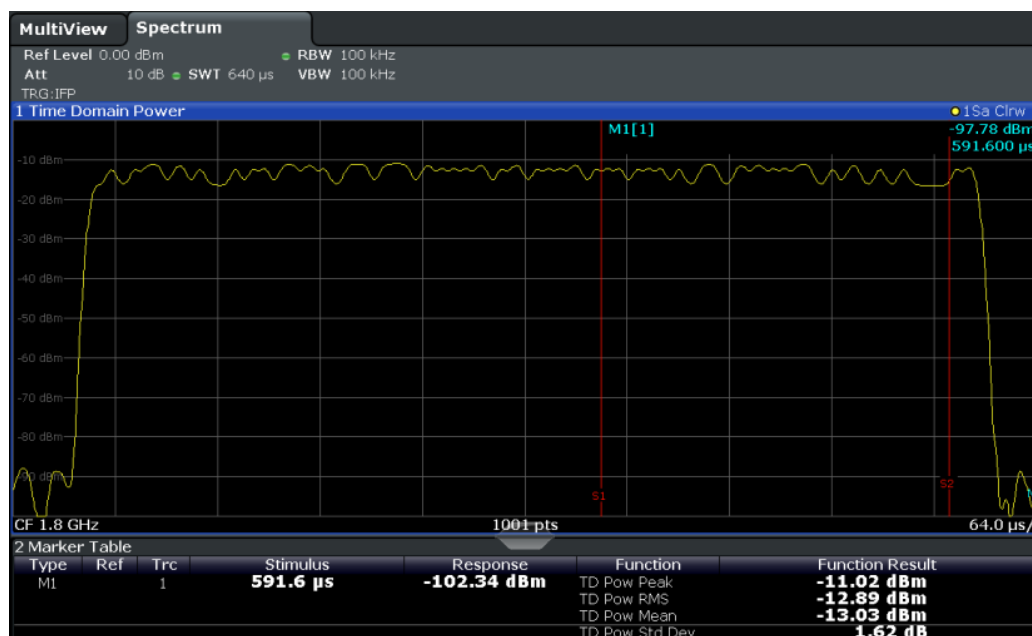

The results can also be queried using the remote commands described in [Chapter 9.6.9, "Measuring the Time Domain Power"](#), on page 665.

### 8.2.9.3 Time Domain Power Basics - Range Definition Using Limit Lines

The range of the measured signal to be evaluated for the power measurement can be restricted using limit lines. The left and right limit lines (S1, S2) define the evaluation range and are indicated by vertical red lines in the diagram. If activated, the power results are only calculated from the levels within the limit lines.

For example, if both the on and off phase of a burst signal are displayed, the measurement range can be limited to the transmission or to the muting phase. The ratio

between signal and noise power of a TDMA signal for instance can be measured by using a measurement as a reference value and then varying the measurement range.



In order to get stable measurement results for a limited evaluation range, usually a trigger is required.

### 8.2.9.4 Time Domain Power Configuration

**Access:** "Overview" > "Select Measurement" > "Time Domain Power" > "Time Dom Power Config"

**Time Domain Power**
X

Results

|         |    |     |
|---------|----|-----|
| Peak    | On | Off |
| RMS     | On | Off |
| Mean    | On | Off |
| Std Dev | On | Off |

Limits

|       |       |     |
|-------|-------|-----|
| State | On    | Off |
| Left  | ----- |     |
| Right | ----- |     |

The remote commands required to perform these tasks are described in [Chapter 9.6.9, "Measuring the Time Domain Power"](#), on page 665.

|                                                |     |
|------------------------------------------------|-----|
| <a href="#">Results</a> .....                  | 364 |
| <a href="#">Limit State</a> .....              | 364 |
| <a href="#">Left Limit / Right Limit</a> ..... | 364 |

**Results**

Activates the power results to be evaluated from the displayed trace or a limited area of the trace.

|           |                                                                                                                                                           |
|-----------|-----------------------------------------------------------------------------------------------------------------------------------------------------------|
| "Peak"    | Peak power over several measurements (uses trace averaging, Max Hold)                                                                                     |
| "RMS"     | RMS value from the points of the displayed trace or a segment thereof.                                                                                    |
| "Mean"    | Mean value from the points of the displayed trace or a segment thereof. The linear mean value of the equivalent voltages is calculated.                   |
| "Std Dev" | The standard deviation of the measurement points from the mean value.<br>The measurement of the mean power is automatically switched on at the same time. |

Remote command:

[CALCulate<n>:MARKer<m>:FUNCTION:SUMMARY:PPEak\[:STATE\]](#) on page 668

[CALCulate<n>:MARKer<m>:FUNCTION:SUMMARY:PPEak:RESULT?](#) on page 671

[CALCulate<n>:MARKer<m>:FUNCTION:SUMMARY:RMS\[:STATE\]](#) on page 668

[CALCulate<n>:MARKer<m>:FUNCTION:SUMMARY:RMS:RESULT?](#) on page 672

[CALCulate<n>:MARKer<m>:FUNCTION:SUMMARY:MEAN\[:STATE\]](#) on page 667

[CALCulate<n>:MARKer<m>:FUNCTION:SUMMARY:MEAN:RESULT?](#) on page 670

**Limit State**

Switches the limitation of the evaluation range on or off. Default setting is off.

If deactivated, the entire sweep time is evaluated. If switched on, the evaluation range is defined by the left and right limit. If only one limit is set, it corresponds to the left limit and the right limit is defined by the stop frequency. If the second limit is also set, it defines the right limit.

Remote command:

[CALCulate<n>:MARKer<m>:X:SLIMITS\[:STATE\]](#) on page 793

**Left Limit / Right Limit**

Defines a power level limit for line S1 (left) or S2 (right).

Remote command:

[CALCulate<n>:MARKer<m>:X:SLIMITS:LEFT](#) on page 793

[CALCulate<n>:MARKer<m>:X:SLIMITS:RIGHT](#) on page 794

**8.2.9.5 How to Measure Powers in the Time Domain**

The step-by-step procedure to measure powers in the time domain is described here in detail.



For remote operation, see [Chapter 9.6.9.4, "Programming Example: Time Domain Power"](#), on page 673.

**To measure the power in the time domain**

1. Select the [MEAS] key.
2. From the "Select Measurement" dialog box, select the "Time Domain Power" measurement function.
3. Select the type of power measurement results to be determined by selecting the corresponding softkeys.
4. To restrict the power evaluation range, define limits:
  - a) Select the "Time Dom Power Config" softkey to display the "Time Domain Power" configuration dialog box.
  - b) Switch on the limits by setting the "Limit State" to "On" .  
The limit lines S1 and S2 are displayed.
  - c) Define the left limit (limit line S1), the right limit (S2), or both.
5. Start a sweep.  
The measured powers are displayed in the marker results.

**8.2.9.6 Measurement Example**

This measurement example demonstrates the time domain power calculation for a GSM burst.

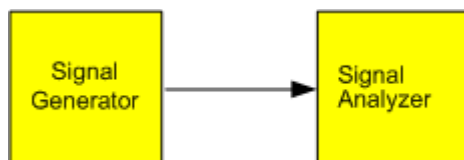
**Test setup:****Signal generator settings (e.g. R&S SMW):**

|             |          |
|-------------|----------|
| Frequency:  | 1.8 GHz  |
| Level:      | -10 dBm  |
| Modulation: | GSM/EDGE |

**Procedure:**

1. Preset the R&S FPL1000.
2. Set the center frequency to *1.8 GHz*.
3. Set the RBW to *100 kHz*.
4. Set the sweep time to *640 μs*.
5. Set the trigger source to "IF Power" .
6. Define a trigger offset of *-50 μs*.

7. Select the "Time Domain Power" measurement function from the "Select Measurement" dialog box.
8. In the Time Domain Power configuration dialog box, set all four results to "On" .
9. Set the "Limit State" to "On" .
10. Define the left limit at 326  $\mu$ s and the right limit at 538  $\mu$ s.  
This range corresponds to the useful part of the GSM burst.

The mean power of the useful part of the GSM burst is calculated to be -13 dBm.

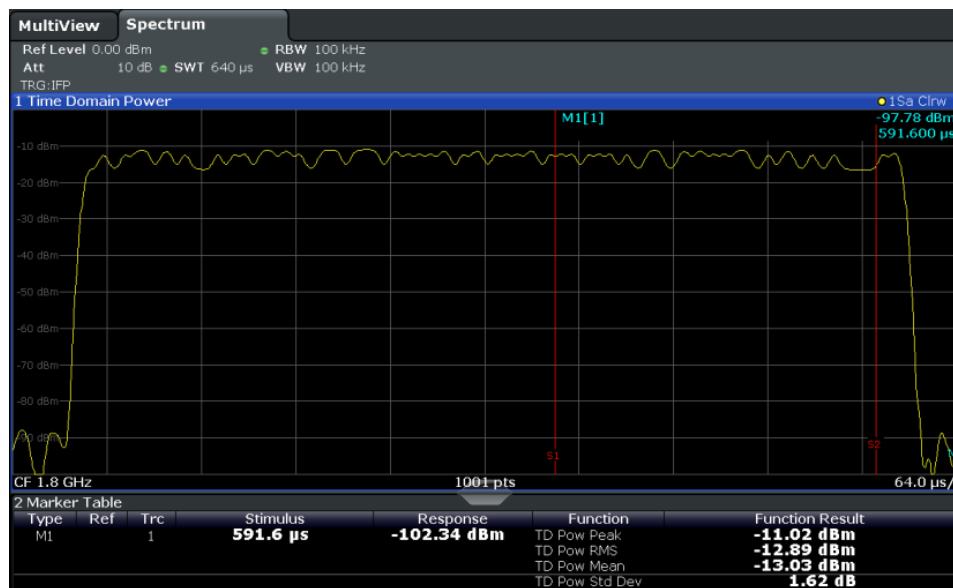

### 8.2.10 Harmonic Distortion Measurement

The "Harmonic Distortion" measurement measures harmonics and their distortion, including the total harmonic distortion.

- [About the Measurement](#).....366
- [Harmonic Distortion Basics](#).....367
- [Harmonic Distortion Results](#).....369
- [Harmonic Distortion Configuration](#).....370
- [How to Determine the Harmonic Distortion](#).....372

#### 8.2.10.1 About the Measurement

With this measurement it is possible to measure the harmonics easily, for example from a VCO. In addition, the total harmonic distortion (THD) is calculated.

For measurements in the frequency domain, the Harmonic Distortion measurement starts with an automatic search for the first harmonic (= peak) within the set frequency range. The center frequency is set to this frequency and the reference level is adjusted accordingly.

For measurements in zero span, the center frequency remains unchanged.

The Harmonic Distortion measurement then performs zero span sweeps at the center frequency and at each harmonic, i.e. at frequencies that are a multiple of the center frequency.

As a result, the zero span sweeps on all harmonics are shown, as well as the RMS values and the total harmonic distortion (THD).



An application note discussing harmonics measurement is available from the Rohde & Schwarz website:

[1EF78: Measurement of Harmonics using Spectrum Analyzers](#)

### 8.2.10.2 Harmonic Distortion Basics

Measuring the harmonics of a signal is a frequent problem which can be solved best using a signal analyzer. In general, every signal contains harmonics. Harmonics are generated by nonlinear characteristics, which add frequencies to a pure sinewave. They can often be reduced by low pass filters. Since the signal analyzer itself has a nonlinear characteristic, for example in its first mixer, measures must be taken to ensure that harmonics produced in the signal analyzer do not cause spurious results. If necessary, the fundamental wave must be attenuated selectively with respect to the other harmonics with a high pass filter. Harmonics are particularly critical regarding high-power transmitters such as transceivers because large harmonics can interfere with other radio services.

Harmonic distortion can be determined as the level of the individual components, or as the root mean square of all components together, the total harmonic distortion (THD). The THD is set in relation to the power of the fundamental frequency (= center frequency).

#### Obtainable dynamic range

When harmonics are being measured, the obtainable dynamic range depends on the second harmonic intercept of the signal analyzer. The second harmonic intercept is the virtual input level at the RF input mixer at which the level of the 2nd harmonic becomes equal to the level of the fundamental wave. In practice, however, applying a level of this magnitude would damage the mixer. Nevertheless the available dynamic range for measuring the harmonic distance of a DUT can be calculated relatively easily using the second harmonic intercept.

As shown in [Figure 8-32](#), the level of the 2<sup>nd</sup> harmonic drops by 20 dB if the level of the fundamental wave is reduced by 10 dB.

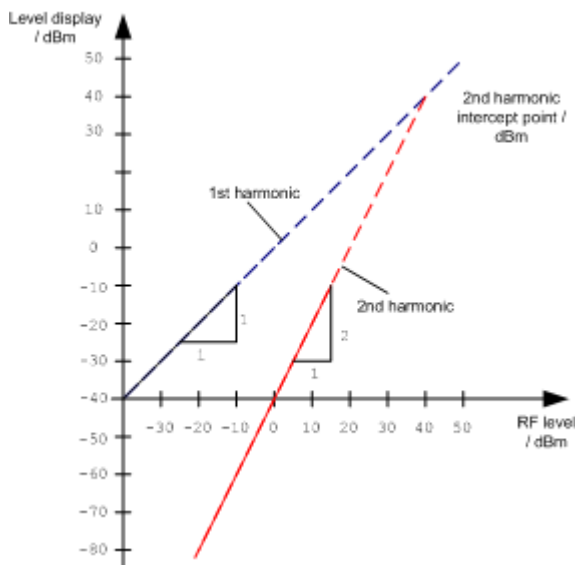

Figure 8-32: Extrapolation of the 1st and 2nd harmonics to the 2nd harmonic intercept at 40 dBm

The following formula for the obtainable harmonic distortion  $d_2$  in dB is derived from the straight-line equations and the given intercept point:

$$d_2 = \text{S.H.I} - P_1 \quad (1)$$

where:

|        |   |                           |
|--------|---|---------------------------|
| $d_2$  | = | harmonic distortion       |
| S.H.I. | = | second harmonic intercept |
| $P_1$  | = | mixer level/dBm           |



The mixer level is the RF level applied to the RF input minus the set RF attenuation.

The formula for the internally generated level  $P_1$  at the 2<sup>nd</sup> harmonic in dBm is:

$$P_1 = 2 * P_i - \text{S.H.I.} \quad (2)$$

The lower measurement limit for the harmonic is the noise floor of the signal analyzer. The harmonic of the measured DUT should – if sufficiently averaged by means of a video filter – be at least 4 dB above the noise floor so that the measurement error due to the input noise is less than 1 dB.

**Rules for measuring high harmonic ratios**

The following rules for measuring high harmonic ratios can be derived:

- Select the smallest possible IF bandwidth for a minimal noise floor.
- Select an RF attenuation which is high enough to measure the harmonic ratio only.



The maximum harmonic distortion is obtained if the level of the harmonic equals the intrinsic noise level of the receiver. The level applied to the mixer, according to (2), is:

$$P_I = \frac{P_{noise} / dBm + IP2}{2}$$

At a resolution bandwidth of 10 Hz (noise level -143 dBm, S.H.I. = 40 dBm), the optimum mixer level is - 51.5 dBm. According to (1) a maximum measurable harmonic distortion of 91.5 dB minus a minimum S/N ratio of 4 dB is obtained.



### Detecting the origin of harmonics

If the harmonic emerges from noise sufficiently (approx. >15 dB), it is easy to check (by changing the RF attenuation) whether the harmonics originate from the DUT or are generated internally by the signal analyzer. If a harmonic originates from the DUT, its level remains constant if the RF attenuation is increased by 10 dB. Only the displayed noise is increased by 10 dB due to the additional attenuation. If the harmonic is exclusively generated by the signal analyzer, the level of the harmonic is reduced by 20 dB or is lost in noise. If both – the DUT and the signal analyzer – contribute to the harmonic, the reduction in the harmonic level is correspondingly smaller.

### High-sensitivity harmonics measurements

If harmonics have very small levels, the resolution bandwidth required to measure them must be reduced considerably. The sweep time is, therefore, also increased considerably. In this case, the measurement of individual harmonics is carried out with the R&S FPL1000 set to a small span. Only the frequency range around the harmonics will then be measured with a small resolution bandwidth.

### Required measurement time

During the harmonics measurement, zero span sweeps are performed at the center frequency and at each harmonic. The duration of each sweep ( "Harmonic Sweep Time" , **SWT**) and the "Number of Harmonics" (n) are defined in the "Harmonic Distortion" configuration dialog box. Thus, the required measurement time for the harmonic distortion measurement (*Cumulated Measurement Time*, **CMT**) is:

$$CMT = n * SWT$$

The required measurement time is indicated as "CMT" in the channel bar.

#### 8.2.10.3 Harmonic Distortion Results

As a result of the harmonics distortion measurement, the zero span sweeps of all detected harmonics are shown in the diagram, separated by red display lines. This provides a very good overview of the measurement.

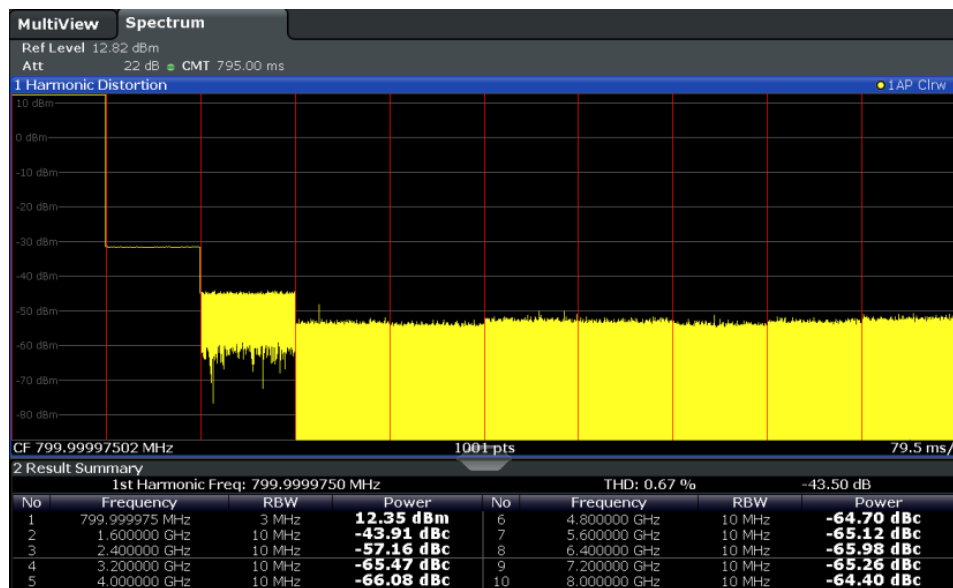

In addition, a result table is displayed providing the following information:

- First harmonic frequency
- THD (total harmonic distortion), relative and absolute values
- For each detected harmonic:
  - Frequency
  - RBW
  - Power

#### Remote commands

The results can also be queried using remote commands.

The first harmonic frequency can be read out via the general center frequency command `[SENSE:]FREQUENCY:CENTer` on page 713.

THD: `CALCulate<n>:MARKer<m>:FUNCTION:HARMonics:DISTortion?`  
on page 677

List of harmonics: `CALCulate<n>:MARKer<m>:FUNCTION:HARMonics:LIST`  
on page 677

#### 8.2.10.4 Harmonic Distortion Configuration

**Access:** "Overview" > "Select Measurement" > "Harmonic Distortion" > "Harmonic Distortion Config"

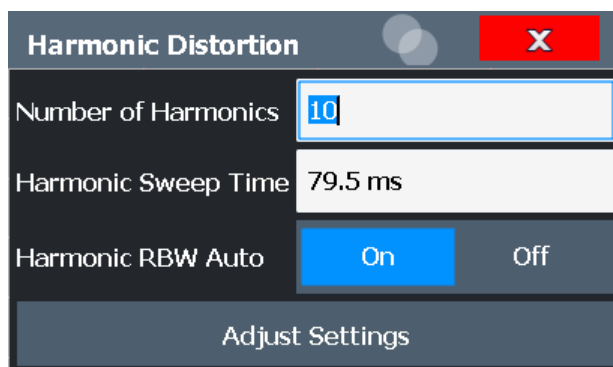

The remote commands required to perform these tasks are described in [Chapter 9.6.10, "Measuring the Harmonic Distortion"](#), on page 675.

|                                           |     |
|-------------------------------------------|-----|
| <a href="#">Number of Harmonics</a> ..... | 371 |
| <a href="#">Harmonic Sweep Time</a> ..... | 371 |
| <a href="#">Harmonic RBW Auto</a> .....   | 371 |
| <a href="#">Adjust Settings</a> .....     | 371 |

### Number of Harmonics

Defines the number of harmonics to be measured. The range is from 1 to 26. Default is 10.

Remote command:

`CALCulate<n>:MARKer<m>:FUNction:HARMonics:NHARmonics` on page 676

### Harmonic Sweep Time

Defines the sweep time for the zero span measurement on each harmonic frequency. This setting is identical to the normal sweep time for zero span, see also "[Sweep Time](#)" on page 442.

Remote command:

`[SENSe:]SWEep:TIME:AUTO` on page 728

### Harmonic RBW Auto

Enables/disables the automatic adjustment of the resolution bandwidth for Normal (3dB) (Gaussian) filter types.

The automatic adjustment is carried out according to:

$$"RBW_n = RBW_1 * n"$$

If  $RBW_n$  is not available, the next higher value is used.

Remote command:

`CALCulate<n>:MARKer<m>:FUNction:HARMonics:BANDwidth:AUTO`  
on page 676

### Adjust Settings

If harmonic measurement was performed in the frequency domain, a new peak search is started in the frequency range that was set before starting the harmonic measurement. The center frequency is set to this frequency and the reference level is adjusted accordingly.

If harmonic measurement was performed in the time domain, this function adjusts the reference level only.

Remote command:

`CALCulate<n>:MARKer<m>:FUNCTION:HARMonics:PRESet` on page 676

### 8.2.10.5 How to Determine the Harmonic Distortion



In Chapter 8.9.6, "Measurement Example: Measuring Harmonics Using Marker Functions", on page 501, measuring harmonics was described using marker functions. This task can be performed much simpler using the Harmonic Distortion measurement, as described in the following procedure.

For remote operation, see Chapter 9.6.10.5, "Example: Measuring the Harmonic Distortion", on page 678.

1. Select the "Harmonic Distortion" measurement function from the "Select Measurement" dialog box.
2. Define the number of harmonics to be determined using the "Number of Harmonics" softkey.
3. Perform a sweep.

The trace for the determined harmonics are displayed in the diagram, separated by red display lines. The measured power for each harmonic in relation to the fundamental is indicated in the result table.

4. If the signal changes significantly during or after the harmonics measurement, use the "Adjust Settings" function to adjust the settings automatically and restart the measurement.

### 8.2.11 Third Order Intercept (TOI) Measurement

The third order intercept point of the R&S FPL1000 can be determined if a two-tone signal with equal carrier levels is applied to the input.

`CALCulate<n>:MARKer<m>:FUNCTION:TOI:RESult?` on page 680

- [About the TOI Measurement](#).....373
- [TOI Basics](#).....373
- [TOI Results](#).....377
- [TOI Configuration](#).....378
- [How to Determine the Third Order Intercept](#).....379
- [Measurement Example – Measuring the R&S FPL1000's Intrinsic Intermodulation](#)  
.....379

### 8.2.11.1 About the TOI Measurement

If several signals are applied to a transmission two-port device with nonlinear characteristic, intermodulation products appear at its output at the sums and differences of the signals. The nonlinear characteristic produces harmonics of the useful signals which intermodulate at the characteristic. The intermodulation products of lower order have a special effect since their level is largest and they are near the useful signals. The intermodulation product of third order causes the highest interference. It is the intermodulation product generated from one of the useful signals and the 2nd harmonic of the second useful signal in case of two-tone modulation.

In order to measure the third order intercept point (TOI), a two-tone signal with equal carrier levels is expected at the R&S FPL1000 input. Marker 1 and marker 2 (both normal markers) are set to the maximum of the two signals. Marker 3 and marker 4 are placed on the intermodulation products.

The R&S FPL1000 calculates the third order intercept point from the level difference between the first 2 markers and the markers 3 and 4 and displays it in the marker table.

### 8.2.11.2 TOI Basics

If several signals are applied to a transmission two-port device with nonlinear characteristic, intermodulation products appear at its output at the sums and differences of the signals. The nonlinear characteristic produces harmonics of the useful signals which intermodulate at the characteristic.

The frequencies of the intermodulation products are above and below the useful signals. The [Figure 8-33](#) shows intermodulation products  $P_{S1}$  and  $P_{S2}$  generated by the two useful signals  $P_{U1}$  and  $P_{U2}$ .

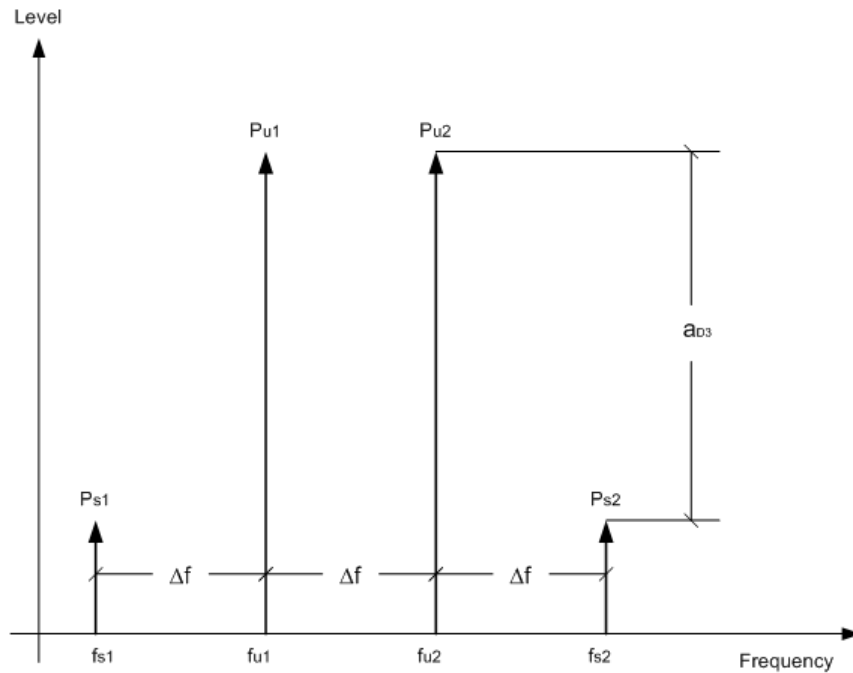

**Figure 8-33: Intermodulation products  $P_{s1}$  and  $P_{s2}$**

The intermodulation product at  $f_{i2}$  is generated by mixing the 2nd harmonic of useful signal  $P_{u2}$  and signal  $P_{u1}$ .

The intermodulation product at  $f_{i1}$  is generated by mixing the 2nd harmonic of useful signal  $P_{u1}$  and signal  $P_{u2}$ .

$$f_{i1} = 2 \times f_{u1} - f_{u2} \quad (1)$$

$$f_{i2} = 2 \times f_{u2} - f_{u1} \quad (2)$$

#### Dependency on level of useful signals

The level of the intermodulation products depends on the level of the useful signals. If the two useful signals are increased by 1 dB, the level of the intermodulation products increases by 3 dB, which means that the spacing  $a_{D3}$  between intermodulation signals and useful signals is reduced by 2 dB. This is illustrated in [Figure 8-34](#).

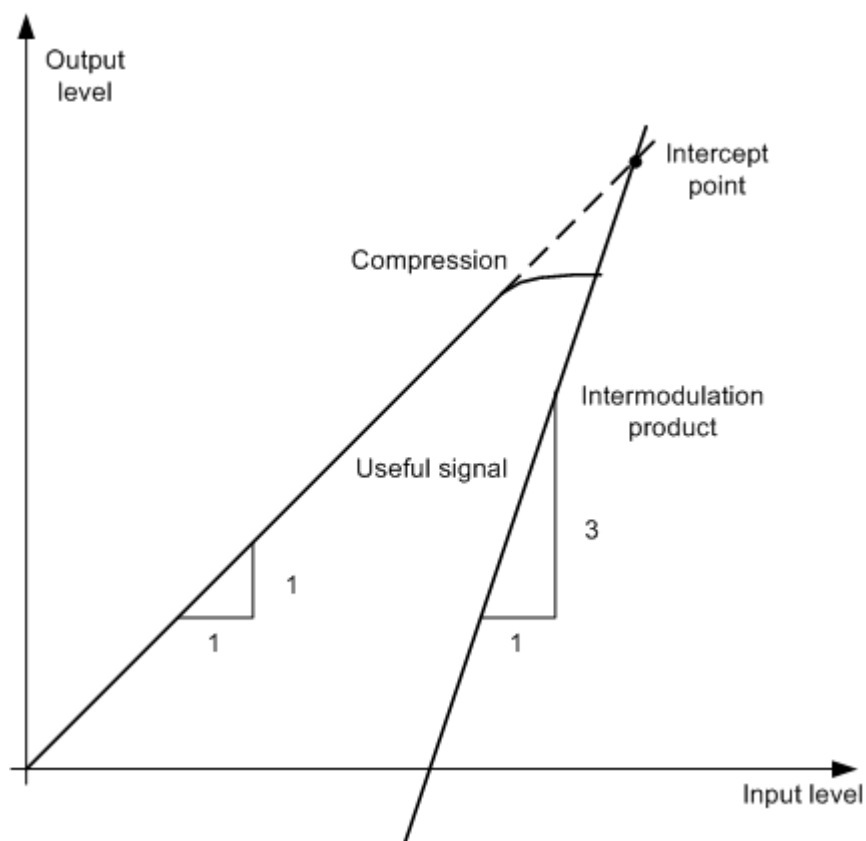

Figure 8-34: Dependency of intermodulation products on level of useful signals

The useful signals at the two-port output increase proportionally with the input level as long as the two-port is in the linear range. A level change of 1 dB at the input causes a level change of 1 dB at the output. Beyond a certain input level, the two-port goes into compression and the output level stops increasing. The intermodulation products of the third order increase three times as quickly as the useful signals. The intercept point is the fictitious level where the two lines intersect. It cannot be measured directly since the useful level is previously limited by the maximum two-port output power.

#### Calculation method

However, the intercept point can be calculated from the known line slopes and the measured spacing  $a_{D3}$  at a given level according to the following formula:

$$IP3 = \frac{a_{D3}}{2} + P_N$$

The third order intercept point (TOI), for example, is calculated for an intermodulation of 60 dB and an input level  $P_U$  of -20 dBm according to the following formula:

$$IP3 = \frac{60}{2} + (-20dBm) = 10dBm$$

### Intermodulation-free dynamic range

The "Intermodulation-free dynamic range", i.e. the level range in which no internal intermodulation products are generated if two-tone signals are measured, is determined by the third order intercept point, the phase noise and the thermal noise of the signal analyzer. At high signal levels, the range is determined by intermodulation products. At low signal levels, intermodulation products disappear below the noise floor, i.e. the noise floor and the phase noise of the signal analyzer determine the range. The noise floor and the phase noise depend on the resolution bandwidth that has been selected. At the smallest resolution bandwidth, the noise floor and phase noise are at a minimum and so the maximum range is obtained. However, a large increase in sweep time is required for small resolution bandwidths. It is therefore best to select the largest resolution bandwidth possible to obtain the range that is required. Since phase noise decreases as the carrier-offset increases, its influence decreases with increasing frequency offset from the useful signals.

The following diagrams illustrate the intermodulation-free dynamic range as a function of the selected bandwidth and of the level at the input mixer (= signal level – set RF attenuation) at different useful signal offsets.

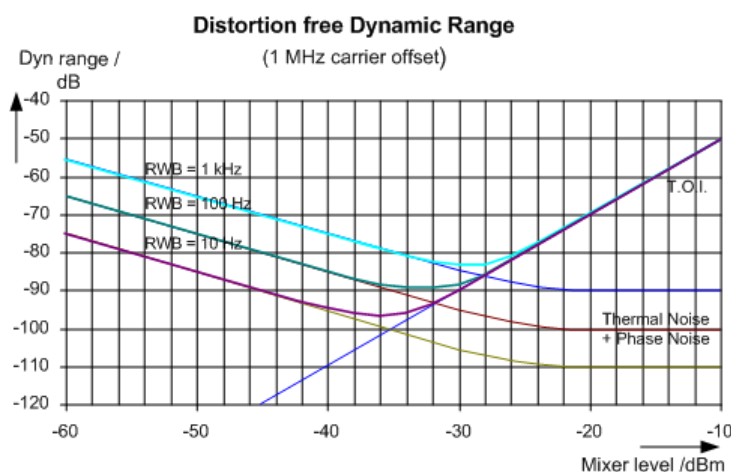

**Figure 8-35: Intermodulation-free range as a function of level at the input mixer and the set resolution bandwidth**

(Useful signal offset = 1 MHz, DANL = -145 dBm/Hz, TOI = 15 dBm; typical values at 2 GHz)

The optimum mixer level, i.e. the level at which the intermodulation distance is at its maximum, depends on the bandwidth. At a resolution bandwidth of 10 Hz, it is approx. -35 dBm and at 1 kHz increases to approx. -30 dBm.

Phase noise has a considerable influence on the intermodulation-free range at carrier offsets between 10 and 100 kHz ( see [Figure 8-36](#)). At greater bandwidths, the influence of the phase noise is greater than it would be with small bandwidths. The optimum mixer level at the bandwidths under consideration becomes almost independent of bandwidth and is approx. -40 dBm.



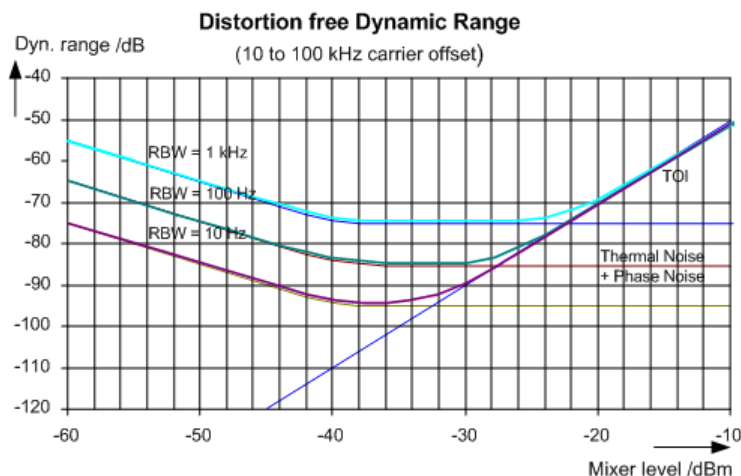

Figure 8-36: Intermodulation-free dynamic range as a function of level at the input mixer and of the selected resolution bandwidth

(Useful signal offset = 10 to 100 kHz, DANL = -145 dBm/Hz, TOI = 15 dBm; typical values at 2 GHz).



If the intermodulation products of a DUT with a very high dynamic range are to be measured and the resolution bandwidth to be used is therefore very small, it is best to measure the levels of the useful signals and those of the intermodulation products separately using a small span. The measurement time will be reduced, in particular if the offset of the useful signals is large. To find signals reliably when frequency span is small, it is best to synchronize the signal sources and the R&S FPL1000.

### 8.2.11.3 TOI Results

As a result of the TOI measurement, the following values are displayed in the marker area of the diagram:

| Label | Description                     |
|-------|---------------------------------|
| TOI   | Third-order intercept point     |
| M1    | Maximum of first useful signal  |
| M2    | Maximum of second useful signal |
| M3    | First intermodulation product   |
| M4    | Second intermodulation product  |

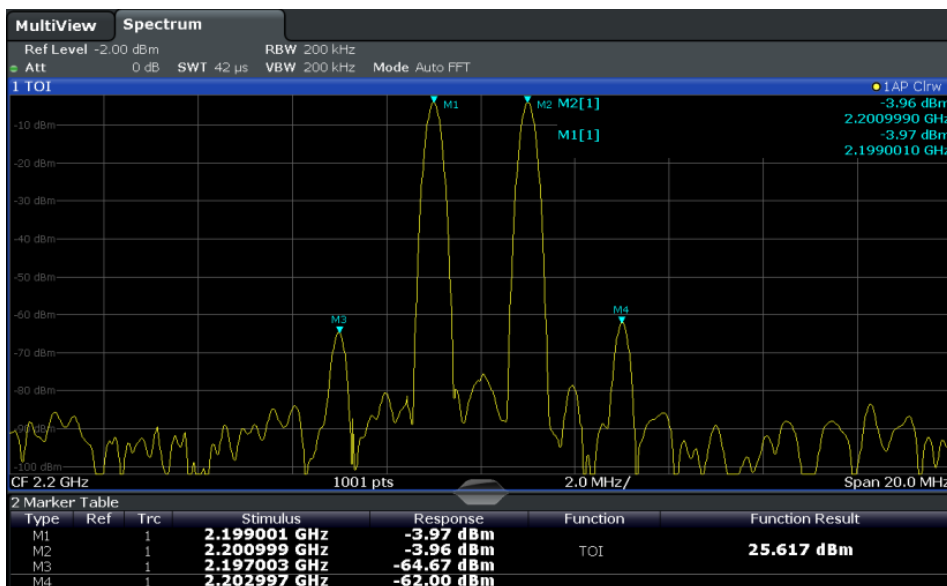

**Remote command**

The TOI can also be queried using the remote command `CALCulate<n>:MARKer<m>:FUNction:TOI:RESult?` on page 680.

**8.2.11.4 TOI Configuration**

**Access:** "Overview" > "Select Measurement" > "Third Order Intercept" > "TOI Config"

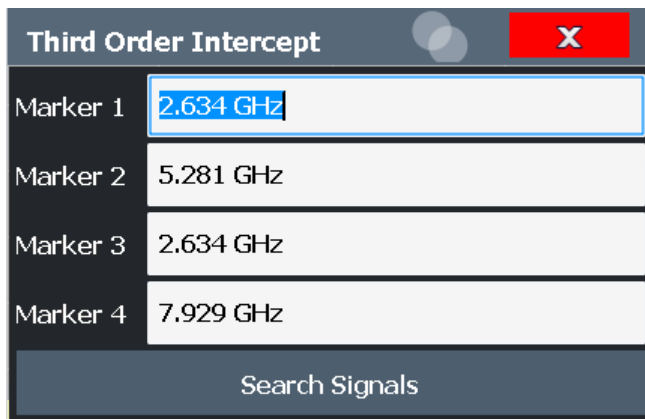

The remote commands required to perform these tasks are described in [Chapter 9.6.11, "Measuring the Third Order Intercept Point"](#), on page 678.

[Marker 1 / Marker 2 / Marker 3 / Marker 4](#) ..... 378  
[Search Signals](#) ..... 379

**Marker 1 / Marker 2 / Marker 3 / Marker 4**

Indicates the detected characteristic values as determined by the TOI measurement (see [Chapter 8.2.11.3, "TOI Results"](#), on page 377).

The marker positions can be edited; the TOI is then recalculated according to the new marker values.

To reset all marker positions automatically, use the [Search Signals](#) function.

Remote command:

`CALCulate<n>:MARKer<m>:X` on page 789

`CALCulate<n>:DELTamarker<m>:X` on page 787

`CALCulate<n>:DELTamarker<m>:X:RELative?` on page 802

### Search Signals

Performs a new search on the input signals and recalculates the TOI according to the measured values.

Remote command:

`CALCulate<n>:MARKer<m>:FUNCTION:TOI:SEARChsignal ONCE` on page 679

#### 8.2.11.5 How to Determine the Third Order Intercept



The precise TOI for the R&S FPL1000 in relation to the input signals is provided in the data sheet.

For remote operation, see [Chapter 9.6.11.2, "Programming Example: Measuring the TOI"](#), on page 680.

1. Apply a two-tone signal with equal carrier levels to the R&S FPL1000 input.
2. On the R&S FPL1000, press the [MEAS] key.
3. Select the "Third Order Intercept" measurement function from the "Select Measurement" dialog box.

The calculated TOI is indicated in the marker information. The markers required for calculation are displayed in the marker table.

4. If the signal changes significantly during or after the TOI measurement, use the "Search Signals" function to start a new signal search automatically and restart the calculation of the TOI.

#### 8.2.11.6 Measurement Example – Measuring the R&S FPL1000's Intrinsic Intermodulation

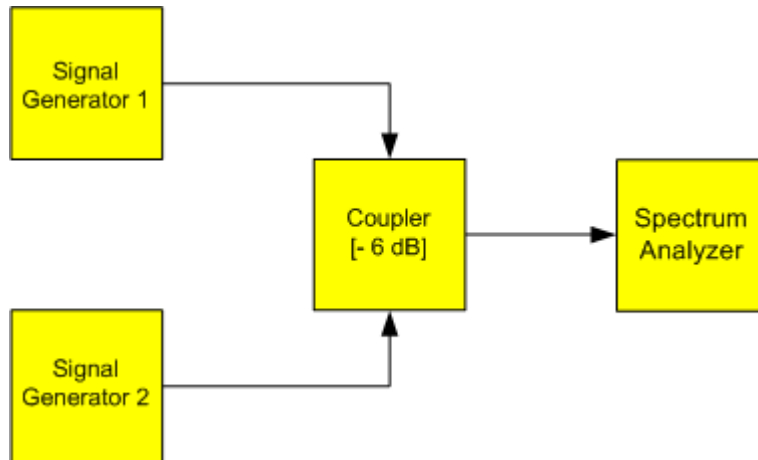

A programming example demonstrating a TOI measurement in a remote environment is provided in [Chapter 9.6.11.2, "Programming Example: Measuring the TOI"](#), on page 680.

**Test setup:****Signal generator settings (e.g. R&S SMW):**

| Device             | Level  | Frequency |
|--------------------|--------|-----------|
| Signal generator 1 | -4 dBm | 799.6 MHz |
| Signal generator 2 | -4 dBm | 800.4 MHz |

**Setting up the measurement**

1. Preset the R&S FPL1000.
2. Set the center frequency to *800 MHz* and the frequency span to *3 MHz*.
3. Set the reference level to *-10 dBm* and RF attenuation to *0 dB*.
4. Set the resolution bandwidth to *10 kHz*.  
The noise is reduced, the trace is smoothed further and the intermodulation products can be seen clearly.
5. Set the VBW to *1 kHz*.

**Measuring intermodulation using the Third Order Intercept (TOI) measurement function**

1. Press the [MEAS] key and select the "Third Order Intercept" measurement function from the "Select Measurement" dialog box.

The R&S FPL1000 activates four markers to measure the intermodulation distance. Two markers are positioned on the useful signals and two on the intermodulation products. The TOI is calculated from the level difference between the useful signals and the intermodulation products. It is then displayed on the screen:

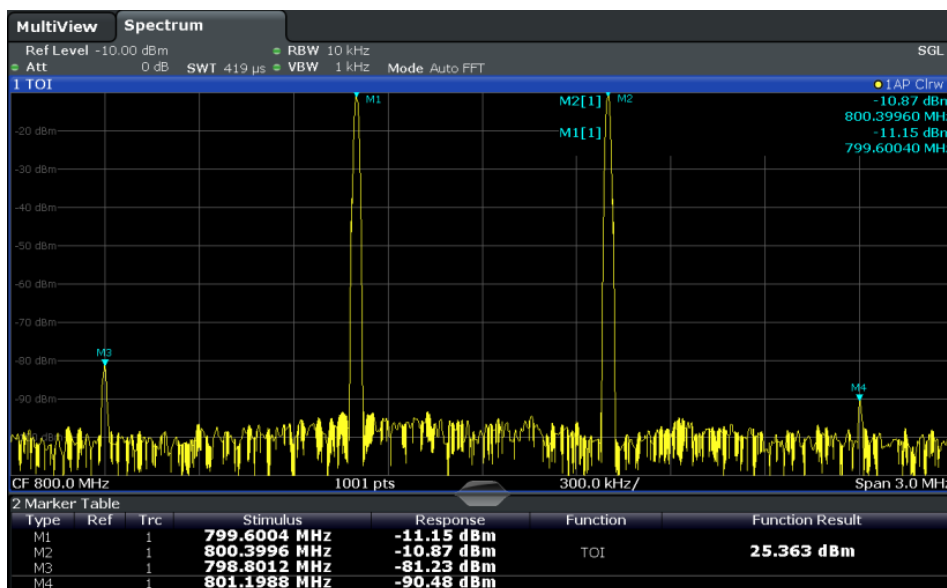

The third order intercept (TOI) is displayed in the marker information.

- The level of a signal analyzer's intrinsic intermodulation products depends on the RF level of the useful signals at the input mixer. When the RF attenuation is added, the mixer level is reduced and the intermodulation distance is increased. With an additional RF attenuation of 10 dB, the levels of the intermodulation products are reduced by 20 dB. The noise level is, however, increased by 10 dB. Increase the RF attenuation to 20 dB to reduce intermodulation products.

The R&S FPL1000's intrinsic intermodulation products disappear below the noise floor.

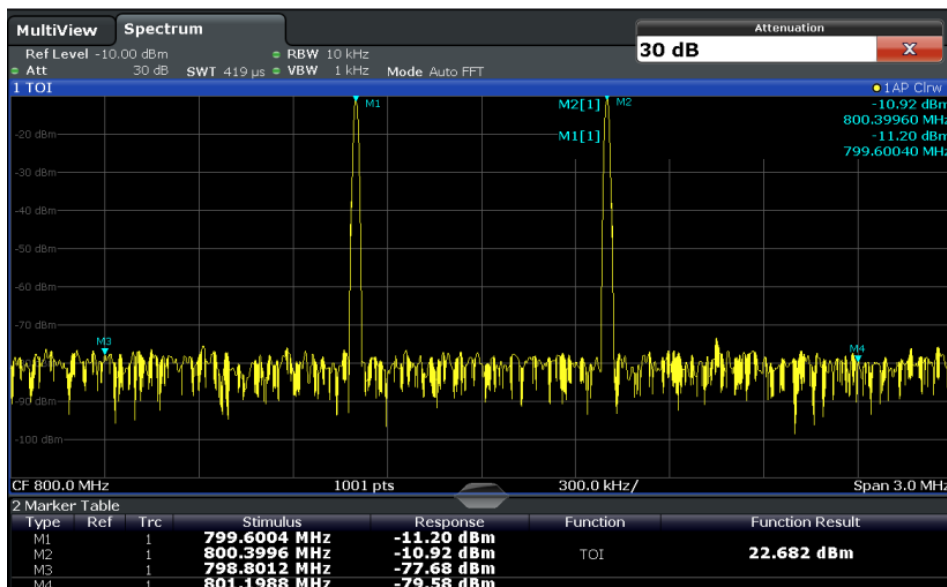

## 8.2.12 AM Modulation Depth Measurement

This measurement determines the AM modulation depth of an AM-modulated carrier.

- [About the Measurement](#).....382
- [AM Modulation Depth Results](#).....382
- [AM Modulation Depth Configuration](#).....383
- [Optimizing and Troubleshooting the Measurement](#).....384
- [How to Determine the AM Modulation Depth](#).....385

### 8.2.12.1 About the Measurement

The AM modulation depth, also known as a modulation index, indicates how much the modulated signal varies around the carrier amplitude. It is defined as:

$$M_{\text{Depth}} = \text{peak signal amplitude} / \text{unmodulated carrier amplitude}$$

So for  $M_{\text{Depth}} = 0.5$ , for example, the carrier amplitude varies by 50% above and below its unmodulated level, and for  $M_{\text{Depth}} = 1.0$  it varies by 100%.

When this measurement is activated, marker 1 is set to the peak level, which is considered to be the carrier level. Delta markers 2 and 3 are automatically set symmetrically to the carrier on the adjacent peak values of the trace. The markers can be adjusted manually, if necessary.

The R&S FPL1000 calculates the power at the marker positions from the measured levels. The AM modulation depth is calculated as the ratio between the power values at the reference marker and at the delta markers. If the powers of the two AM side bands are unequal, the mean value of the two power values is used for AM modulation depth calculation.

### 8.2.12.2 AM Modulation Depth Results

As a result of the AM Modulation Depth measurement, the following values are displayed in the marker area of the diagram:

| Label  | Description                                        |
|--------|----------------------------------------------------|
| MDepth | AM modulation depth in percent                     |
| M1     | Maximum of the signal (= carrier level)            |
| D2     | Offset of next peak to the right of the carrier    |
| D3     | Offset of the next peak to the left of the carrier |

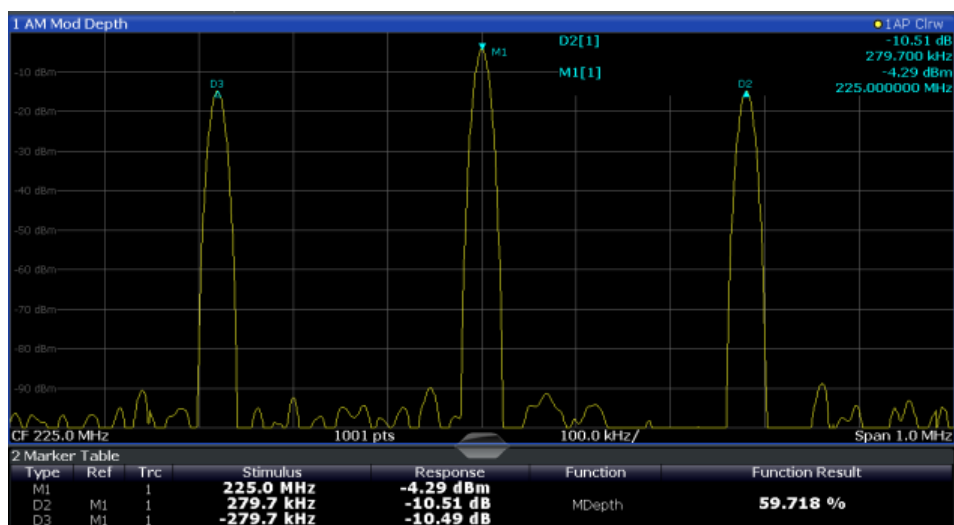

**Remote command:**

The AM modulation depth can also be queried using the remote command `CALCulate<n>:MARKer<m>:FUNCTION:MDEPth:RESult<t>?` on page 682.

**8.2.12.3 AM Modulation Depth Configuration**

**Access:** "Overview" > "Select Measurement" > "AM Modulation Depth" > "AM Mod Depth Config"

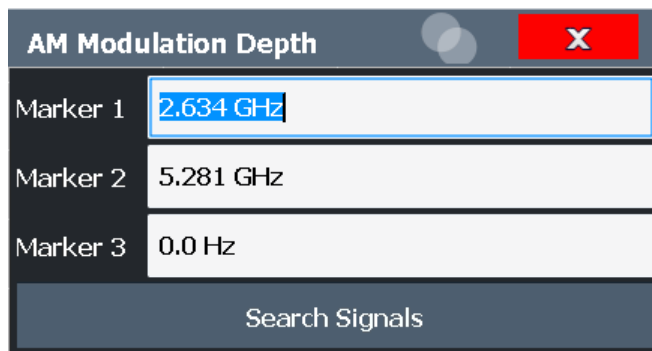

The remote commands required to perform these tasks are described in [Chapter 9.6.12, "Measuring the AM Modulation Depth"](#), on page 681.

[Marker 1 / Marker 2 / Marker 3](#) .....383  
[Search Signals](#) ..... 384

**Marker 1 / Marker 2 / Marker 3**

Indicates the detected characteristic values as determined by the AM Modulation Depth measurement:

| Marker | Description                                        |
|--------|----------------------------------------------------|
| M1     | Maximum of the signal (= carrier level)            |
| D2     | Offset of next peak to the right of the carrier    |
| D3     | Offset of the next peak to the left of the carrier |

The marker positions can be edited; the modulation depth is then recalculated according to the new marker values.

To reset all marker positions automatically, use the [Search Signals](#) function.

**Note:** Moving the marker positions manually. When the position of delta marker 2 is changed, delta marker 3 is moved symmetrically with respect to the reference marker 1.

Delta marker 3, on the other hand, can be moved for fine adjustment independently of marker 2.

Marker 1 can also be moved manually for re-adjustment without affecting the position of the delta markers.

Remote command:

[CALCulate<n>:MARKer<m>:X](#) on page 789

[CALCulate<n>:DELTAmarker<m>:X](#) on page 787

[CALCulate<n>:DELTAmarker<m>:X:RELative?](#) on page 802

### Search Signals

Performs a new search on the input signal and recalculates the AM Modulation Depth according to the measured values.

Remote command:

[CALCulate<n>:MARKer<m>:FUNCTION:MDEPTH:SEARCHsignal ONCE](#)

on page 681

#### 8.2.12.4 Optimizing and Troubleshooting the Measurement

If the results do not meet your expectations, try the following methods to optimize the measurement:

- Set the center frequency to the frequency of the device under test.
- Adjust the span so the peaks to the left and right of the carrier, produced by the AM modulated signal, are clearly visible.  
If the span is too wide, these signals may fall together with the carrier and the measurement can not be performed.  
If the span is too narrow, these signals are outside of the measured span and the delta markers can not find these peaks.  
The rule of thumb is to set the span to three times the value of the AM modulation frequency.



### 8.2.12.5 How to Determine the AM Modulation Depth

The following step-by-step instructions demonstrate how to determine the AM modulation depth.



For remote operation, see [Chapter 9.6.12.2, "Example: Measuring the AM Modulation Depth"](#), on page 682.

1. Apply a modulated carrier signal to the R&S FPL1000 input.
2. On the R&S FPL1000, press the [MEAS] key.
3. Select the "AM Modulation Depth" measurement function from the "Select Measurement" dialog box.  
The calculated AM Modulation Depth is indicated in the marker information. The markers required for calculation are displayed in the marker table.
4. If the signal changes significantly during or after the AM Modulation Depth measurement, use the "Search Signals" function to start a new peak search automatically and restart the calculation of the AM Modulation Depth.

### 8.2.13 Electromagnetic Interference (EMI) Measurement

The optional electromagnetic interference (EMI) measurement (R&S FPL1-K54) is suitable for measurements according to commercial and military electromagnetic compatibility (EMC) standards. The functionality of the measurement is particularly useful in research and development.

The EMI measurement features:

- EMI marker functionality
  - Marker demodulation
  - Measurement bandwidths and detectors for EMI measurements
  - Logarithmic scaling of the frequency axis
  - Additional predefined limit lines for EMC standards
  - Predefined transducer factors
  - Additional amplitude units, normalized to 1 MHz
  - LISN control
- [About the EMI Measurement](#)..... 386
  - [EMI Measurement Results](#)..... 386
  - [EMI Measurement Basics](#)..... 387
  - [EMI Measurement Configuration](#)..... 395
  - [EMI Result Analysis](#)..... 404
  - [How to Perform EMI Measurements](#)..... 404
  - [Measurement Example: Measuring Radio Frequency Interference](#)..... 406
  - [Optimizing and Troubleshooting EMI Measurements](#)..... 409

### 8.2.13.1 About the EMI Measurement

EMI measurements can be very time-consuming, especially if weighting detectors are required for the measurement. In addition, EMC testing often requires various procedures to locate local EMI maxima. Such procedures are, for example, movements of an absorbing clamp, variations in the height of the test antenna or the rotation of the DUT.

Covering all test setups with one of the (slow) EMI weighting detectors over the required frequency range would lead to very high measurement times.

Splitting the measurement procedure into several stages, however, can eliminate this problem.

The first stage, or peak search, is used to get a rough idea about the location of peak levels that may indicate interference over the required frequency range. This stage uses a detector that allows for a fast sweep time, e.g. the peak detector.

During the second stage, or final test, the R&S FPL1000 performs the actual EMC test, a refined measurement with detectors designed for and required by EMC standards. To keep measurement times brief, the R&S FPL1000 performs a final measurement only on frequencies you have marked with a marker or delta marker. You can assign a different detector to every marker and thus test a particular frequency easily for compliance.

Optionally, you can activate audio demodulation of the signal at the peak marker positions during the final test (requires the optional additional interfaces R&S FPL1-B5).

After the final measurement, you can check the signal levels against specified limits.

### 8.2.13.2 EMI Measurement Results

As the result of an R&S FPL1 EMI measurement, the measured signal levels and active markers are displayed in a Spectrum diagram.

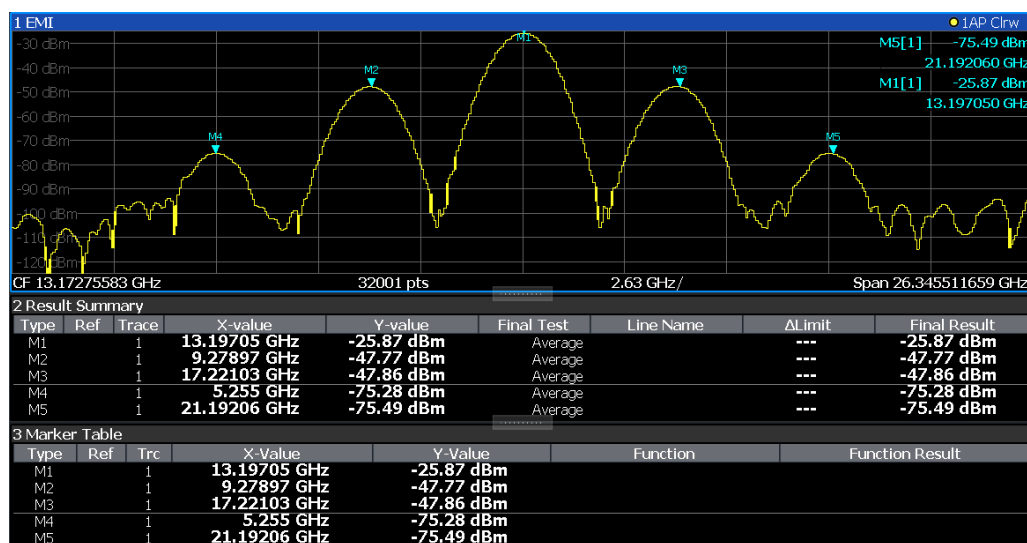

Figure 8-37: EMI measurement results

### Initial peak search results - Marker Table

As a result of the initial peak search, the active markers are set to the positive peaks of the measured signal.

If **Auto peak search and limit lines** are active, the active markers are set to the peak *delta* values between the measured signal and the limit lines.

The active marker levels and positions are displayed in the **Marker Table**.

(Note: the marker results are also displayed in the Result Summary; in addition, the Marker Table contains the marker results for those markers for which no final EMI test is performed.)

### Final test results - Result Summary

The results of the final EMI tests at the active marker frequencies are displayed in the **Result Summary**.

The Result Summary provides the following information:

| Label          | Description                                                                                                                                                                                                                                                                            |
|----------------|----------------------------------------------------------------------------------------------------------------------------------------------------------------------------------------------------------------------------------------------------------------------------------------|
| Type           | Marker name                                                                                                                                                                                                                                                                            |
| Ref            | Reference marker for delta markers                                                                                                                                                                                                                                                     |
| Trace          | Assigned trace                                                                                                                                                                                                                                                                         |
| X-value        | Marker x-value (frequency for final test)                                                                                                                                                                                                                                              |
| Y-value        | Marker y-value (level during initial measurement)                                                                                                                                                                                                                                      |
| Final Test     | Detector used for final EMI test                                                                                                                                                                                                                                                       |
| Line name      | Line activated for limit check                                                                                                                                                                                                                                                         |
| $\Delta$ Limit | Delta between measured level and limit line (if active)<br>The value is colored to indicate the following states: <ul style="list-style-type: none"> <li>• <b>green</b>: does not exceed limit</li> <li>• <b>yellow</b>: within margin</li> <li>• <b>red</b>: exceeds limit</li> </ul> |
| Final Result   | Value measured during final EMI test using specified detector at marker frequency                                                                                                                                                                                                      |

### 8.2.13.3 EMI Measurement Basics

Some background knowledge on basic terms and principles used in EMI measurements is provided here for a better understanding of the required configuration settings.

- [Resolution Bandwidth and Filter Types](#).....388
- [Detectors and Dwell Time](#).....388
- [Frequency Resolution - Sweep Points and Scaling](#).....391
- [Controlling V-Networks \(LISN\)](#).....392
- [Using Transducer Factors](#).....393

- [Initial Measurement - Peak Search](#).....393
- [Final Measurement at the Marker Position](#)..... 394
- [Limit Checks](#).....395

### Resolution Bandwidth and Filter Types

EMI testing requires resolution filters with a 6 dB bandwidth. The R&S FPL1000 EMI measurement adds the following bandwidths that comply to commercial and military standards to those already available with the base unit:

Commercial (CISPR, FFC etc.)

- 200 Hz
- 9 kHz
- 120 kHz
- 1 MHz (not with Quasipeak detector, see "[Quasipeak detector \(CISPR filter only\)](#)" on page 389)

Military (MIL Std)

- 10 Hz
- 100 Hz
- 1 kHz
- 10 kHz
- 100 kHz
- 1 MHz

For the Quasipeak, CISPR Average, or RMS Average detector, the bandwidth is fixed depending on the frequency. For more information see "[Detectors and Dwell Time](#)" on page 388.

### Detectors and Dwell Time

The EMI measurement adds new detectors to those already available with the base unit. The additional detectors are especially designed for and required by EMI applications.

The additional detectors are available only if the EMI (R&S FPL1-K54) measurement option is installed and the filter type "CISPR" or "MIL" is selected (see "[Resolution Bandwidth and Filter Types](#)" on page 388).

The detector to be used for the initial peak search is configured in the trace settings (see [Chapter 8.10.1.2, "Trace Settings"](#), on page 509), while the detector for the final test is configured in the EMI marker settings, see "[EMI Marker Configuration](#)" on page 396.

### Dwell time

EMC tests often require a specific *dwell time* for an EMI measurement. The dwell time defines how long the R&S FPL1000 measures the signal at the individual frequencies. Each detector needs a different period of time to fully charge and discharge; the individual requirements on the dwell time are described for each detector. For details on

defining the dwell time for an R&S FPL1 EMI measurement see ["Defining a Dwell Time for the Final Measurement"](#) on page 395.

### Positive and negative peak detector

The maximum and minimum peak detectors display the maximum and minimum signal level that was detected during the specified dwell time.

The minimum and maximum peak detectors are already available with the base unit.

Consider the following when defining the dwell time:

- **Unmodulated signals:** minimum time required by the detector
- **Pulsed signals:** the time must be long enough to capture at least one complete pulse

### Average detector

The average detector displays the average signal level of the samples that were collected during the specified dwell time.

The average detector is already available with the base unit.

Consider the following when defining the dwell time:

- **Unmodulated signals:** minimum time required by the detector
- **Pulsed signals:** the time must be long enough to capture several complete pulses (at least 10)
- The time is determined by the lowest modulation frequency to be averaged

### RMS detector

The RMS detector displays the root mean square (RMS) value over the specified dwell time. The integration time is the specified dwell time.

The RMS detector is already available with the base unit.

The same considerations apply to the dwell time as for the average detector.

### Sample detector

The sample detector displays the last value from the samples allocated to a pixel.

The sample detector is used for noise or phase noise marker calculation. However, it is unreliable if the displayed span is much greater than the resolution bandwidth or if the tuning steps of the local oscillator are too large. The sample detector is not recommended for EMI tests.

### Quasipeak detector (CISPR filter only)

The quasipeak detector displays the maximum signal level weighted to CISPR 16-1-1 that was detected during the dwell time.

The quasipeak detector is only available for the CISPR filter, and not for an RBW of 1 MHz.

The filter bandwidth and time parameters of the detector depend on the measured frequency. The time lag of the simulated pointer instrument reflects the weighting factor of the signal depending on its form, modulation, etc.

**Table 8-16: Required parameters depending on frequency for CISPR quasipeak detector**

|                                              | Band A    | Band B            | Band C/D |
|----------------------------------------------|-----------|-------------------|----------|
| Frequency range                              | < 150 kHz | 150 kHz to 30 MHz | > 30 MHz |
| Resolution bandwidth                         | 200 Hz    | 9 kHz             | 120 kHz  |
| Charge time                                  | 45 ms     | 1 ms              | 1 ms     |
| Discharge time                               | 500 ms    | 160 ms            | 550 ms   |
| Time lag of the simulated pointer instrument | 160 ms    | 160 ms            | 100 ms   |

Consider the following when defining the dwell time:

- **Unknown signals:** select a dwell time of at least 1 second to ensure that pulses down to a frequency of 5 Hz are weighted correctly
- **Known signals:** shorter dwell time possible, as the signal level does not change during the final measurement

#### CISPR Average detector (CISPR filter only)

The CISPR Average detector displays a weighted average signal level according to CISPR 16-1-1.

The average value according to CISPR 16-1-1 is the maximum value detected while calculating the linear average value during the specified dwell time.

The CISPR Average detector is only available for the CISPR filter.

The CISPR Average detector is applied to measure pulsed sinusoidal signals with a low pulse frequency, for example. It is calibrated with the RMS value of an unmodulated sinusoidal signal. The average value is determined by lowpass filters of the 2nd order (simulating a mechanical pointer instrument).

The filter bandwidth and time lag of the detector depend on the measured frequency. The time lag of the simulated pointer instrument reflects the weighting factor of the signal depending on its form, modulation, etc.

**Table 8-17: Required parameters depending on frequency for CISPR Average detector**

|                                              | Band A   | Band B            | Band C/D        | Band E |
|----------------------------------------------|----------|-------------------|-----------------|--------|
| Frequency range                              | <150 kHz | 150 kHz to 30 MHz | 30 MHz to 1 GHz | >1 GHz |
| IF bandwidth                                 | 200 Hz   | 9 kHz             | 120 kHz         | 1 MHz  |
| Time lag of the simulated pointer instrument | 160 ms   | 160 ms            | 100 ms          | 100 ms |

Consider the following when defining the dwell time:

- **Unknown signals:** select a dwell time of at least 1 second to ensure that pulses down to a frequency of 5 Hz are weighted correctly

- **Pulsed signals or signals that fluctuate slowly:** the dwell time must cover at least the time until the first signal peak is measured; can require long dwell time
- **unmodulated signals or signals with a high modulation frequency:** the dwell time must cover at least the time until the first signal peak is measured; usually shorter than for pulsed signals

### RMS Average detector (CISPR filter only)

The RMS Average detector is a combination of the RMS detector (for pulse repetition frequencies above a corner frequency) and the Average detector (for pulse repetition frequencies below the corner frequency). It thus achieves a pulse response curve with the following characteristics:

- 10 dB/decade above the corner frequency
- 20 dB/decade below the corner frequency

The average value is determined by lowpass filters of the 2nd order (simulation of a mechanical pointer instrument).

The RMS Average detector is only available for the CISPR filter.

The detector is used, for example, to measure broadband emissions and may replace the quasipeak detector in the future.

The detector parameters depend on the measured frequency. The time lag of the simulated pointer instrument reflects the weighting factor of the signal depending on its form, modulation, etc.

**Table 8-18: Required parameters depending on frequency for RMS Average detector**

|                                          | Band A   | Band B            | Band C/D        | Band E |
|------------------------------------------|----------|-------------------|-----------------|--------|
| Frequency range                          | <150 kHz | 150 kHz to 30 MHz | 30 MHz to 1 GHz | >1 GHz |
| IF bandwidth                             | 200 Hz   | 9 kHz             | 120 kHz         | 1 MHz  |
| Time lag of simulated pointer instrument | 160 ms   | 160 ms            | 100 ms          | 100 ms |
| Corner frequency                         | 10 Hz    | 100 Hz            | 100 Hz          | 1 kHz  |

The same considerations apply to the dwell time as for the CISPR average detector.

### Frequency Resolution - Sweep Points and Scaling

The number of sweep points defines the number of measurement values collected during one sweep. Thus, increasing the sweep points also increases the accuracy of the results regarding the frequency resolution.

Because EMI measurements often cover a large frequency range you should define an adequate number of sweep points, especially when performing the measurement on a logarithmic axis. As on a linear axis, the distance from one sweep point to the next is calculated graphically on a logarithmic axis, and is not based on the frequency itself. Thus, the frequency resolution between two sweep points deteriorates with higher frequencies.

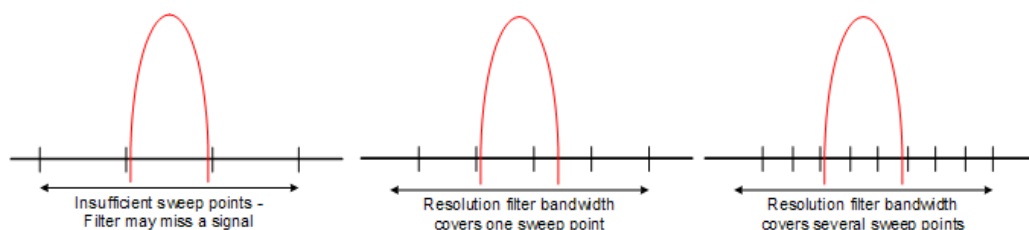

The resolution bandwidth should cover at least one sweep point (more is better). If this condition is not met, signals or interferences could be missed during refined measurement of narrowband interferences. If the distance between two sweep points is larger than  $RBW/3$ , a warning is displayed in the status bar ( "Increase Sweep Points" ).

### Example:

Linear axis:

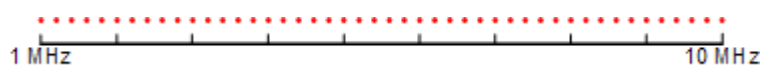

With a linear axis, the distance between the sweep points is equal, e.g. 200 kHz.

Logarithmic axis:

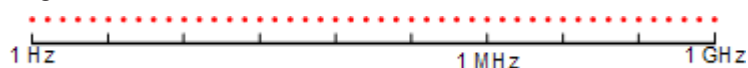

With a logarithmic axis, the distance between sweep points is variable. In the spectrum from 10 Hz to 100 Hz, the distance is a few Hz. Between 100 MHz and 1 GHz, the distance is several MHz.

The R&S FPL1000 EMI measurement supports a maximum of 200001 sweep points.

This number is based on typical bands measured with a single resolution bandwidth. There are sufficient sweep points to make sure that a signal is found during the refined measurement, even when covering 30 MHz to 1 GHz with logarithmic scaling and 120 kHz RBW.

### Controlling V-Networks (LISN)

For measurements on power lines, the R&S FPL1 EMI measurement adds functionality to control a line impedance stabilization network (LISN) directly. Thus you can determine the interference caused by power supplies and cables.

This feature requires the optional additional interfaces (R&S FPL1-B5).

You can connect the LISN to the user port of the R&S FPL1000. Control cables for the various LISNs are available as accessories. The R&S FPL1000 then controls which phase of the LISN is to be tested and outputs the information to the user port.

The R&S FPL1 EMI measurement supports several V-networks. For each type of network, you can define the phase you want to test for interferences. The R&S FPL1 EMI measurement allows you to test one phase at a time.



**Table 8-19: Supported networks and phases**

| Network type                | Phases        |
|-----------------------------|---------------|
| <b>Two-line V-networks</b>  |               |
| ESH3-Z5                     | N, L1         |
| ENV216                      | N, L1         |
| <b>Four-line V-networks</b> |               |
| ESH2-Z5                     | N, L1, L2, L3 |
| ENV4200                     | N, L1, L2, L3 |

For the ENV216 network, a 150 kHz high pass filter is available to protect the input of the R&S FPL1000.

### Using Transducer Factors

The R&S FPL1000 EMI measurement provides functionality to include transducer factors in the test setup. Transducers are devices like antennas, probes or current probes that are connected to the R&S FPL1000 to measure interferences or useful signals. The transducer converts the measured value such as field strength, current or RFI voltage into a voltage across 50  $\Omega$ . During the measurement, the transducer is considered a part of the instrument.

A transducer usually has a frequency-dependent transducer factor that includes the frequency response of the corresponding device. During level measurement, the transducer factor automatically converts the results into the correct unit and magnitude. A transducer factor consists of a maximum of 1001 reference values. Each reference value includes frequency, unit and level.

The R&S FPL1 EMI measurement adds several predefined transducer factors. In addition you can also create new and edit existing transducer factors.

For more information see [Chapter 7.3.6.1, "Basics on Transducer Factors"](#), on page 152 .

### Initial Measurement - Peak Search

The purpose of an initial peak search is to find signals with a high interference level quickly. The peak search is performed with a fast detector like the peak or average detector. The initial peak search is the basis for a possible refined measurement of interferences with the detectors specific to EMI measurements.

The results of the initial peak search are shown in the Marker Table (see [Chapter 8.2.13.2, "EMI Measurement Results"](#), on page 386).

Peak searches can be performed automatically or manually.

### Automatic peak search

If enabled, the automatic peak search starts as soon as you select the EMI measurement and one or more markers are active. During automatic peak search, the R&S FPL1000 looks for the strongest peaks in the frequency range you are measuring

and positions a marker on those peaks after each sweep. If a **limit line** is assigned to the trace, the peak search is based on the level difference between the trace and the limit line. For each active marker a peak is searched. You can use up to 16 markers simultaneously.

The largest peak is always assigned to the active marker with the lowest number; subsequent peaks are assigned to the active markers in ascending order.

The R&S FPL1000 allows you to distribute markers among several traces. If you do so, the marker with the lowest number assigned to a particular trace is positioned on the largest peak of the corresponding trace.

### Manual peak search

If automatic peak search is off, you can set the markers to any frequency you need more information about manually. You can change the marker position with the rotary knob or the cursor keys, or position it to a particular frequency with the number keys.

Setting markers is the same as setting markers in other Spectrum measurements. For more information see [Chapter 8.9, "Marker Usage"](#), on page 463.

### Searching for peaks over several traces

You can search for peaks on six traces simultaneously with a different weighting detector for each trace.

In this case, the R&S FPL1000 searches for peaks on all traces separately, provided that you have assigned at least one marker to each trace.

A typical selection for EMI measurement is to use the peak and the average detector. After initial measurement, search for peaks on the peak trace and the average trace separately so that the distribution of narrowband and wideband sources of interference can be taken into account.

### Example:

- In the initial measurement, determine the peak on one trace using the average detector by assigning a marker to that trace. For the marker frequency, perform a refined measurement using the CISPR or RMS average detector.
- In the initial measurement, determine the peak on another trace using the peak detector by assigning another marker to that trace. For this marker frequency, perform a refined measurement using the quasipeak detector.

### Final Measurement at the Marker Position

Finding peaks with the help of an initial marker peak search reduces data to be evaluated and thus measurement time. A final measurement with a special EMI detector can then refine the initial results.

The R&S FPL1 EMI measurement performs the final measurement automatically as soon as a detector for the final test is defined for an EMI marker and the marker is activated. The final measurement starts immediately after the marker has been set. The advantage of an immediate final measurement is that it eliminates the risk of measurement errors based on frequency drifts of the disturbance signal.

The final measurement at the marker frequency may have a different detector than during the initial peak search. Thus, the final measurement consumes much less time because detectors with a long measurement time are needed only at the critical frequency.

The R&S FPL1 EMI measurement also allows you to use multiple detectors for the final measurement. The advantage of multiple detection is that you only need one test run to see if the results comply with the limits specified in a standard. The detectors for the final EMI tests are defined in the marker configuration as opposed to the *trace* detector which is used for the initial peak search.)

The results of the final measurement are shown in the Result Summary (see [Chapter 8.2.13.2, "EMI Measurement Results"](#), on page 386).

### Defining a Dwell Time for the Final Measurement

EMC tests often require a specific *dwell time* for an EMI measurement. The dwell time defines how long the R&S FPL1000 measures the signal at the frequencies of the marker positions. The dwell time is identical for all EMI final measurements and is thus defined in the EMI measurement configuration. Select a dwell time according to the characteristics of the measured signal. See also ["Detectors and Dwell Time"](#) on page 388.

### Limit Checks

General limit line functionality is provided by the R&S FPL1000 base unit. The base unit also provides various predefined limit lines that you can use for various applications. The R&S FPL1 EMI measurement adds further predefined limit lines designed in compliance with several EMC standards.

When using limit lines in combination with EMI measurements, the marker levels from the initial measurement are compared to the limit line values. The result of the limit line check is displayed in the diagram as usual.

In the EMI Result Summary, the limit check is based on the results of the final test. Since the marker may be determined using a different detector than the final test results, the two limit check results may differ. The difference between the limit line and the measured value is colored to indicate the following states:

- **green**: does not exceed limit
- **yellow**: within margin
- **red**: exceeds limit

For more information on using limit lines see [Chapter 8.11.2.1, "Basics on Limit Lines"](#), on page 538.

#### 8.2.13.4 EMI Measurement Configuration

**Access:** "Overview" > "Select Measurement" > "EMI" > "EMI Config"

On the R&S FPL1, EMI measurement configuration consists of the following settings.

In addition, some common settings are also relevant for EMI measurements:

- Chapter 7.3.6.2, "Transducer Settings", on page 154
- "Reference Level" on page 429
- Chapter 8.11.2.2, "Limit Line Settings and Functions", on page 542
- EMI Marker Configuration..... 396
- EMI Final Measurement Configuration.....399
- LISN Control Settings.....402

**EMI Marker Configuration**

**Access:** [MKR] > "Marker Config"

The initial peak search for the R&S FPL1 EMI measurement is defined by the marker configuration.

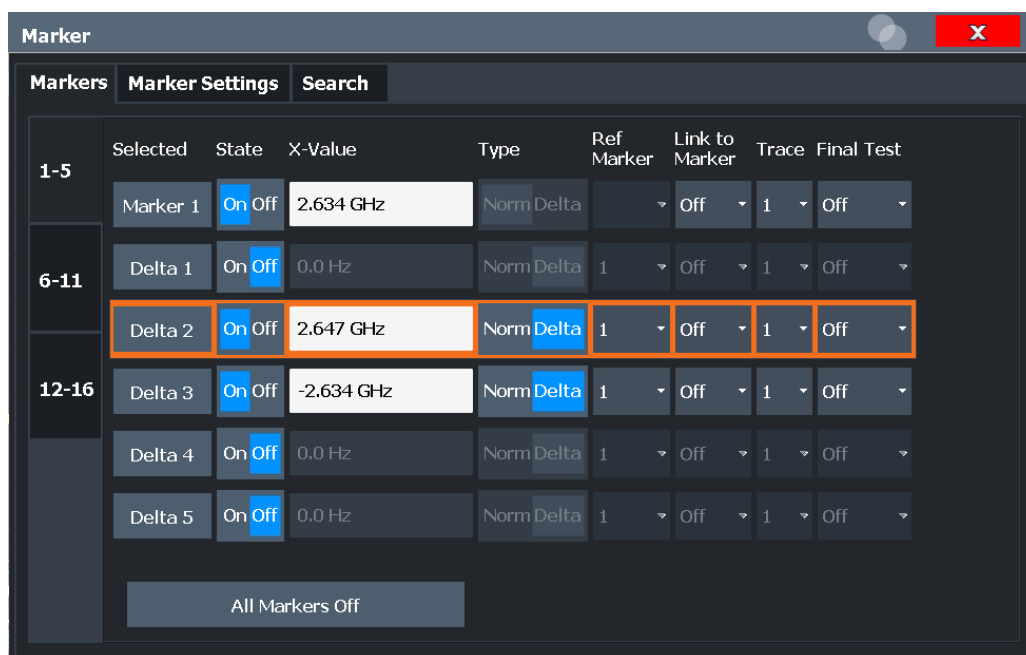

- Selected Marker ..... 396
- Marker State ..... 397
- Marker Position X-value ..... 397
- Marker Type ..... 397
- Reference Marker ..... 397
- Linking to Another Marker ..... 397
- Assigning the Marker to a Trace ..... 398
- Final Test Detector ..... 398
- Select Marker ..... 399

**Selected Marker**

Marker name. The marker which is currently selected for editing is highlighted orange.

Remote command:

Marker selected via suffix <m> in remote commands.

**Marker State**

Activates or deactivates the marker in the diagram.

Remote command:

[CALCulate<n>:MARKer<m>\[:STATe\]](#) on page 789

[CALCulate<n>:DELTAmarker<m>\[:STATe\]](#) on page 787

**Marker Position X-value**

Defines the position (x-value) of the marker in the diagram. For normal markers, the absolute position is indicated. For delta markers, the position relative to the reference marker is provided.

Remote command:

[CALCulate<n>:MARKer<m>:X](#) on page 789

[CALCulate<n>:DELTAmarker<m>:X](#) on page 787

**Marker Type**

Toggles the marker type.

The type for marker 1 is always "Normal", the type for delta marker 1 is always "Delta". These types cannot be changed.

**Note:** If normal marker 1 is the active marker, switching the "Mkr Type" activates an additional delta marker 1. For any other marker, switching the marker type does not activate an additional marker, it only switches the type of the selected marker.

"Normal"            A normal marker indicates the absolute value at the defined position in the diagram.

"Delta"            A delta marker defines the value of the marker relative to the specified reference marker (marker 1 by default).

Remote command:

[CALCulate<n>:MARKer<m>\[:STATe\]](#) on page 789

[CALCulate<n>:DELTAmarker<m>\[:STATe\]](#) on page 787

**Reference Marker**

Defines a marker as the reference marker which is used to determine relative analysis results (delta marker values).

If the reference marker is deactivated, the delta marker referring to it is also deactivated.

If a fixed reference point is configured (see ["Defining a Fixed Reference"](#) on page 471), the reference point ("FXD") can also be selected instead of another marker.

Remote command:

[CALCulate<n>:DELTAmarker<m>:MREference](#) on page 786

**Linking to Another Marker**

Links the current marker to the marker selected from the list of active markers. If the x-axis value of the initial marker is changed, the linked marker follows to the same position on the x-axis. Linking is off by default.

Using this function you can set two markers on different traces to measure the difference (e.g. between a max hold trace and a min hold trace or between a measurement and a reference trace).

Remote command:

[CALCulate<n>:MARKer<ms>:LINK:TO:MARKer<md>](#) on page 788

[CALCulate<n>:DELTAmarker<ms>:LINK:TO:MARKer<md>](#) on page 785

[CALCulate<n>:DELTAmarker<m>:LINK](#) on page 785

### Assigning the Marker to a Trace

The "Trace" setting assigns the selected marker to an active trace. The trace determines which value the marker shows at the marker position. If the marker was previously assigned to a different trace, the marker remains on the previous frequency or time, but indicates the value of the new trace.

If a trace is turned off, the assigned markers and marker functions are also deactivated.

Remote command:

[CALCulate<n>:MARKer<m>:TRACe](#) on page 789

### Final Test Detector

Defines the detector to be used for the final EMI test at the marker frequency.

This setting is only available if the EMI (R&S FPL1-K54) measurement option is installed.

For details, see ["Detectors and Dwell Time"](#) on page 388.

**Note:** The trace detector configured in the trace settings is used for the initial peak search only, see [Chapter 8.10.1.2, "Trace Settings"](#), on page 509.

|                 |                                                                                                                                                                                                                                                                                                                                                                                 |
|-----------------|---------------------------------------------------------------------------------------------------------------------------------------------------------------------------------------------------------------------------------------------------------------------------------------------------------------------------------------------------------------------------------|
| "Off"           | No final test is performed.                                                                                                                                                                                                                                                                                                                                                     |
| "PositivePeak"  | Determines the maximum signal level that was detected during the specified dwell time.                                                                                                                                                                                                                                                                                          |
| "Average"       | Determines the average signal level of the samples that were collected during the specified dwell time.                                                                                                                                                                                                                                                                         |
| "Quasi-Peak"    | Determines the maximum signal level weighted to CISPR 16-1-1 that was detected during the dwell time.<br>The "Quasi-Peak" detector is only available for the CISPR filter, and not for an RBW of 1 MHz.                                                                                                                                                                         |
| "CISPR Average" | Determines a weighted average signal level according to CISPR 16-1-1.<br>The average value according to CISPR 16-1-1 is the maximum value detected while calculating the linear average value during the specified dwell time.<br>The "CISPR Average" detector is only available for the CISPR filter.                                                                          |
| "RMS Average"   | A combination of the RMS detector (for pulse repetition frequencies above a corner frequency) and the Average detector (for pulse repetition frequencies below the corner frequency).<br>Lowpass filters of the second order determine the average value (simulation of a mechanical pointer instrument).<br>The "RMS Average" detector is only available for the CISPR filter. |

Remote command:

`CALCulate<n>:MARKer<m>:FUNCTION:FMEasurement:DETECTOR` on page 684

`CALCulate<n>:DELTAmarker<m>:FUNCTION:FMEasurement:DETECTOR`  
on page 684

### Select Marker

The "Select Marker" function opens a dialog box to select and activate or deactivate one or more markers quickly.



Remote command:

`CALCulate<n>:MARKer<m>[:STATe]` on page 789

`CALCulate<n>:DELTAmarker<m>[:STATe]` on page 787

### EMI Final Measurement Configuration

The final EMI measurement can be performed with different settings than the initial peak search. These settings are described here.

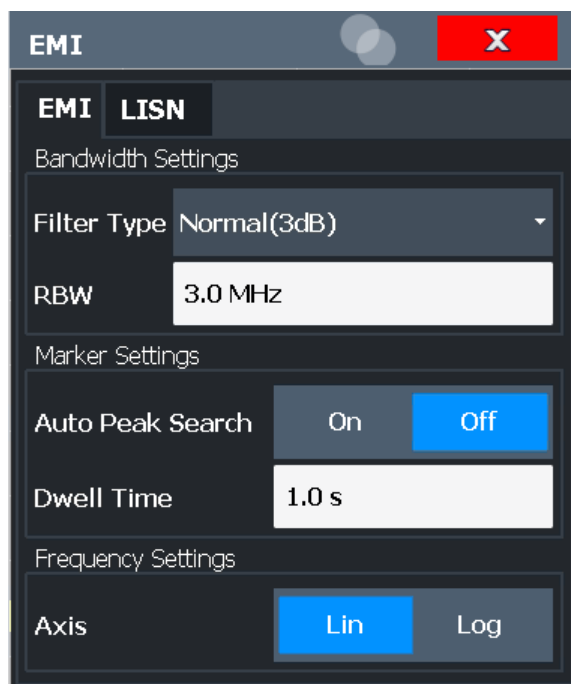

The detector to be used for the final EMI test can be defined differently for each frequency, thus the detector is configured in the EMI marker settings, see "[Final Test Detector](#)" on page 398.

|                                              |     |
|----------------------------------------------|-----|
| <a href="#">Filter Type</a> .....            | 400 |
| <a href="#">RBW</a> .....                    | 401 |
| <a href="#">Automatic Peak Search</a> .....  | 401 |
| <a href="#">Dwell Time</a> .....             | 401 |
| <a href="#">Frequency Axis Scaling</a> ..... | 401 |
| <a href="#">Res BW CISPR</a> .....           | 402 |
| <a href="#">Res BW MIL</a> .....             | 402 |

### Filter Type

Defines the filter type.

The following filter types are available:

- Normal (3dB)
- Channel
- CISPR (6 dB) - requires EMI (R&S FPL1-K54) option
- MIL Std (6 dB) - requires EMI (R&S FPL1-K54) option

For more information see [Chapter 8.6.1.6, "Which Data May Pass: Filter Types"](#), on page 438.

**Note:** The EMI-specific filter types are available if the EMI (R&S FPL1-K54) measurement option is installed, even if EMI measurement is not active. For details see "[Resolution Bandwidth and Filter Types](#)" on page 388.

The RBW filter configured in the bandwidth settings is identical to the filter configured in the EMI configuration.



Remote command:

`[SENSe:]BANDwidth[:RESolution]:TYPE` on page 723

### RBW

Defines the resolution bandwidth. The available resolution bandwidths are specified in the data sheet. Numeric input is always rounded to the nearest possible bandwidth.

If "Auto" is selected, the resolution bandwidth is coupled to the selected span (for span > 0). If the span is changed, the resolution bandwidth is automatically adjusted.

If the resolution bandwidth is defined manually, a green bullet is displayed next to the "RBW" display in the channel bar.

For more information see [Chapter 8.6.1.1, "Separating Signals by Selecting an Appropriate Resolution Bandwidth"](#), on page 435.

**Note:** Restrictions.

- For EMI measurements using the quasipeak detector, the 1 MHz RBW filter is not available (see ["Resolution Bandwidth and Filter Types"](#) on page 388).

Remote command:

`[SENSe:]BANDwidth[:RESolution]` on page 722

`[SENSe:]BANDwidth[:RESolution]:AUTO` on page 722

### Automatic Peak Search

If activated, a peak search is performed automatically for all active markers after each sweep.

If Auto peak search *and* limit lines are active, the active markers are set to the peak *delta* values between the measured signal and the limit lines.

**Note:** The general search functions [Auto Max Peak Search / Auto Min Peak Search](#) are not available for EMI measurements.

Remote command:

`CALCulate<n>:MARKer<m>:FUNCTION:FMEasurement:PEAKsearch:AUTO`  
on page 685

### Dwell Time

Sets the dwell time for the EMI marker measurement.

For more information see ["Detectors and Dwell Time"](#) on page 388.

Remote command:

`CALCulate<n>:MARKer<m>:FUNCTION:FMEasurement:DWELL` on page 685

### Frequency Axis Scaling

Switches between linear and logarithmic scaling for the frequency axis.

By default, the frequency axis has linear scaling. Logarithmic scaling of the frequency axis, however, is common for measurements over large frequency ranges as it enhances the resolution of the lower frequencies. On the other hand, high frequencies get more crowded and become harder to distinguish.

This function is only available for EMI measurements (require option R&S FPL1-K54), and only for resolution bandwidths (RBW) up to 1 MHz.

For more information see [Chapter 8.4.1.3, "Coping with Large Frequency Ranges - Logarithmic Scaling"](#), on page 419.

Remote command:

`DISPlay[:WINDow<n>][:SUBWindow<w>]:TRACe<t>:X:SPACing` on page 713

### **Res BW CISPR**

Defines the measurement bandwidth for commercial EMC standards according to CISPR.

For more information see ["Resolution Bandwidth and Filter Types"](#) on page 388.

Remote command:

Filter type:

`[SENSe:]BANDwidth[:RESolution]:TYPE` on page 723

Filter bandwidth:

`[SENSe:]BANDwidth[:RESolution]` on page 722

### **Res BW MIL**

Defines the measurement bandwidth for military EMC standards.

For more information see ["Resolution Bandwidth and Filter Types"](#) on page 388.

Remote command:

Filter type:

`[SENSe:]BANDwidth[:RESolution]:TYPE` on page 723

Filter bandwidth:

`[SENSe:]BANDwidth[:RESolution]` on page 722

### **LISN Control Settings**

**Access:** [MEAS CONFIG] > "LISN Config"

For measurements with power lines, the following settings are available for the R&S FPL1000 to control which phase of the LISN is to be tested (e.g. for EMI measurements). LISN control requires the EMI measurement (R&S FPL1-K54) option.

It also requires the optional additional interfaces (R&S FPL1-B5).

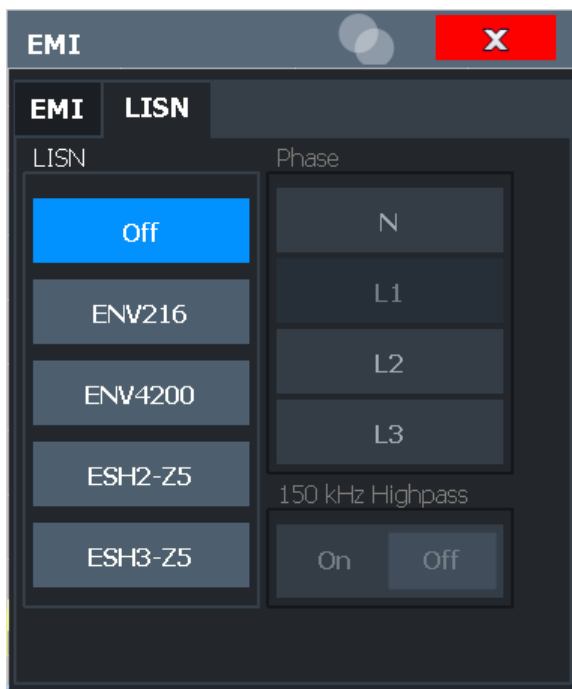

For more information see "Controlling V-Networks (LISN)" on page 392.

|                        |     |
|------------------------|-----|
| LISN Type .....        | 403 |
| Phase .....            | 403 |
| 150 kHz Highpass ..... | 403 |

**LISN Type**

Selects the network type and activates output to the network via the user port of the R&S FPL1000. The network type determines the supported phases (see Table 8-19).

"Off" disables LISN control and output.

Remote command:

`INPut<ip>:LISN[:TYPE]` on page 687

**Phase**

Selects the phase to be measured. Phase N and L1 are included in all four LISN. Phase L2 and L3 are only included in four-line networks.

You can select one phase only for each measurement.

Remote command:

`INPut<ip>:LISN:PHASe` on page 686

**150 kHz Highpass**

Enables or disables the use of an additional 150 kHz highpass filter to protect the R&S FPL1000 LISN from excessive input.

The filter is available for the ENV 216 network only.

Remote command:

`INPut<ip>:LISN:FILTER:HPASs[:STATe]` on page 686

### 8.2.13.5 EMI Result Analysis

The R&S FPL1 EMI measurement provides functionality to analyze the results.

#### Marker Demodulation

The R&S FPL1000 is able to demodulate AM and FM signals for acoustic tests and monitoring purposes.

When the demodulator function is active, the R&S FPL1 EMI measurement demodulates the signal continuously (regardless of the "Continuous Demodulation" setting in the marker function configuration). The demodulation begins as soon as a marker is activated. During the initial measurement, demodulation is performed for the entire measurement span; during the final measurement only the detected peak marker positions are demodulated (for the defined dwell time). You can listen to the results during the measurement using headphones or the internal speaker.

In FFT mode, demodulation is only performed during the final measurement. You do not hear any results during the initial measurement.

This feature requires the optional additional interfaces (R&S FPL1-B5).

For more information see [Chapter 8.9.4.7, "Demodulating Marker Values and Providing Audio Output \(Marker Demodulation\)"](#), on page 493.

#### Limit Lines

General limit line functionality is provided by the R&S FPL1000 base unit. The base unit also provides various predefined limit lines that you can use for various applications. The R&S FPL1 EMI measurement adds further predefined limit lines designed in compliance with several EMC standards.

Limit line configuration is described in [Chapter 8.11.2.2, "Limit Line Settings and Functions"](#), on page 542.

### 8.2.13.6 How to Perform EMI Measurements

The following step-by-step instructions demonstrate how to perform an EMI measurement with the R&S FPL1000 EMI measurement option.



For remote operation, see [Chapter 9.6.13.8, "Programming Example: EMI Measurement"](#), on page 689.

---

1. Press the [MODE] key on the front panel and select the "Spectrum" application.
2. Define the frequency range of the EMI measurement.
  - a) Press the [FREQ] key and then the "Frequency Config" softkey.
  - b) Define the start and stop frequency.
3. Configure the traces for the initial EMI measurement.
  - a) Press the [TRACE] key.

- b) Select the "Trace Config" softkey to configure as many traces as required.
4. Press the [MEAS] key on the front panel and select the "EMI" measurement.  
The EMI main menu is displayed.
5. Select the "EMI Config" softkey and define the resolution bandwidth and filter type to be used for the measurement.  
By default, the R&S FPL1000 uses a filter with a 3 dB bandwidth. EMI measurements usually require a filter with a 6 dB bandwidth.
6. Define the dwell time for which each marker position is measured during the final measurement.
7. To obtain an overview of peak values in the input signal during the initial measurement, activate the "Auto Peak Search" .  
  
As soon as a sweep is started, the R&S FPL1000 looks for the strongest peaks in the frequency range you are measuring and positions one of the active markers on those peaks. The number of active markers determines the number of detected peaks; no additional markers are activated.
8. Define the type of scaling for the frequency axis according to the definition of the limit lines in the standard.
9. Optionally, select the "LISN Config" softkey to configure a LISN control.  
(This feature requires the optional additional interfaces R&S FPL1-B5).
10. Configure the EMI measurement markers.
  - a) Select the "Marker Config" softkey and activate the number of markers or delta markers you want to analyze.
  - b) For each active marker, select a detector to be used for the "Final Test" , that is: the subsequent EMI measurement at the marker position.
  - c) If you already know which frequencies cause irregular values, set the markers to those positions. (Otherwise perform an initial peak search to obtain an overview, see [step 7](#)).
11. Optionally, select the "Marker Demod Config" softkey to configure continuous marker demodulation.  
Demodulation begins immediately with the next measurement. During the initial measurement, demodulation is performed for the entire measurement span; during the final measurement only the detected peak marker positions are demodulated (for the defined dwell time).  
(This feature requires the optional additional interfaces R&S FPL1-B5).  
In FFT mode, demodulation is only performed during the final measurement. You do not hear any results during the initial measurement.
12. Increase the number of sweep points for the EMI measurement.
  - a) Press the [SWEEP] key on the front panel.
  - b) Select the "Sweep Config" softkey.
  - c) Set the number of "Sweep Points" so that the distance between two sweep points is smaller than  $RBW/3$ .

13. Optionally, select or configure limit lines against which the marker results are checked.
  - a) Press the [Lines] key and then the "Lines Config" softkey, then select the "Lines Config" tab.
  - b) In the "Line Config" dialog box, select the "View Filter" option: "Show Compatible" .  
All stored limit lines with the file extension `.LIN` in the `limits` subfolder of the main installation folder of the instrument that are compatible to the current EMI measurement settings are displayed in the overview.
  - c) Select the "Check Traces" setting for a limit line in the overview and select the trace numbers to be included in the limit check. One limit line can be assigned to several traces.
14. Define a suitable unit for the measured values, as the default unit dBm is not suitable for EMI measurements, or select a transducer.  
To change the unit:  
Press the [AMPT] key, then select the "Amplitude Config" softkey and, in the "Amplitude" dialog box, select the required unit.  
To select a transducer:
  - a) Press the [SETUP] key.
  - b) Select the "Transducer" softkey.
  - c) In the "Transducer" dialog box, set the "View Filter" to "Show Compatible" to determine the available transducers for the current EMI measurement setup.
  - d) Select a transducer line in the overview and select the "Active" setting for it.
15. Press the [RUN SINGLE] key to start a new EMI measurement.  
If activated, a peak search is performed. For each active marker, a final measurement is performed using the specified detector for the specified dwell time. If activated, the signal is demodulated at the active marker positions.  
The specified traces to be checked are compared with the active limit lines. The status of the limit check for the final measurement is indicated in the Result Summary.

#### 8.2.13.7 Measurement Example: Measuring Radio Frequency Interference

A common measurement task that you can do with the R&S FPL1 EMI measurement is to detect radio frequency interference (RFI) or electromagnetic interferences (EMI).

The measurement shows signal levels over a particular frequency range. A typical frequency range for EMI measurements is 150 kHz to 1 GHz. As the captured signal characteristics will most likely be unknown, the best way to start the measurement is to preset the R&S FPL1000 and perform a peak search to obtain a general overview.

If you perform measurements according to a particular EMI standard, a preset also eliminates the risk of wrong settings inherited from previous measurements. Note that EMI measurements are possible in the Spectrum application only.



A programming example demonstrating an EMI measurement in a remote environment is provided in [Chapter 9.6.13.8, "Programming Example: EMI Measurement"](#), on page 689.

### Preparing the measurement

1. Press the [PRESET] key.  
The R&S FPL1000 restores the default settings.
2. Define the frequency range of the measurement.
  - a) Press the [FREQ] key.
  - b) Press the "Start Frequency" softkey and enter a frequency of 150 kHz.
  - c) Press the "Stop Frequency" softkey and enter a frequency of 1 GHz.  
The R&S FPL1000 scales the horizontal axis accordingly.
3. Press the [MEAS] key on the front panel and select the "EMI" measurement.  
The EMI main menu is displayed.
4. Select the "EMI Config" softkey and define the resolution bandwidth and filter type to be used for the measurement.  
By default, the R&S FPL1000 uses a filter with a 3 dB bandwidth. EMI measurements usually require a filter with a 6R&S FPL1000dB bandwidth.
5. Define the dwell time for which each marker position is measured during the final measurement.
6. To obtain an overview of exceptional values in the input signal during the initial measurement, activate the "Auto Peak Search" .
7. Select the measurement bandwidth.
  - a) Select the "Res BW CISPR" softkey.  
A CISPR (6 dB) filter is configured.
  - b) Set the bandwidth to 1 MHz.  
The R&S FPL1000 shows the currently selected resolution bandwidth in the diagram header.
8. Configure the traces for the initial EMI measurement.
  - a) Press the [TRACE] key.
  - b) Press the "Trace Config" softkey to configure two traces.
  - c) Define the detectors to use for the initial measurement. Select the peak detector for trace 1 and the average detector for trace 2.  
The peak detector ensures that the detected peak levels in the frequency range covered by one pixel are displayed.  
The R&S FPL1000 now displays two traces. Trace 1 shows the peak values, trace 2 shows the average values.
9. Increase the number of sweep points for the EMI measurement.

- a) Press the [SWEEP] key on the front panel.
  - b) Select the "Sweep Config" softkey.
  - c) Set the number of "Sweep Points" to 200000.
10. Press the [AMPT] key, then select the "Amplitude Config" softkey and, in the "Amplitude" dialog box, select V as the "Unit" .

### Performing the measurement

1. Configure the EMI measurement markers. In this example we will use 6 markers.
  - a) Select the "Marker Config" softkey and activate six normal markers.
  - b) Set markers 1 to 3 on trace 1. Set markers 4 to 6 on trace 2.
  - c) For each of these markers, select the "CISPR AV" detector to be used for the "Final Test" , i.e. the subsequent EMI measurement at the marker positions.
2. Select a limit line against which the marker results are checked.
  - a) Press the [Lines] key and then the "Lines Config" softkey, then select the "Lines Config" tab.
  - b) In the "Line Config" dialog box, select the "View Filter" option: "Show Compatible" .

All stored limit lines with the file extension .LIN in the `limits` subfolder of the main installation folder of the instrument that are compatible to the current EMI measurement settings are displayed in the overview.
  - c) In the overview, click the "Check Traces" setting for the EN55011A limit line and select trace 1 to be included in the limit check. (Trace 2, which is defined as the average, will always be lower than trace 1, which contains peak values.)
3. Press the [RUN SINGLE] key to start a new EMI measurement.

If activated, a peak search is performed. For each active marker, a final measurement is performed using the specified detector for the specified dwell time.

If activated, the signal is demodulated. During the initial measurement, demodulation is performed for the entire measurement span; during the final measurement only the detected peak marker positions are demodulated (for the defined dwell time).

The specified traces to be checked are compared with the active limit line. The status of the limit check for the final measurement is indicated in the Result Summary.

### Evaluating the measurement

Check the Result Summary to detect exceeded limit values.

Zoom into the diagram at the conspicuous frequency for more details.

If necessary, decrease the span to the area in which irregular values occurred and repeat the measurement.



### 8.2.13.8 Optimizing and Troubleshooting EMI Measurements

If the results do not meet your expectations, try the following methods to optimize the measurement:

#### Number of sweep points

The resolution bandwidth should cover at least one sweep point (more is better). If this condition is not met, signals or interferences could be missed during refined measurement of narrowband interferers. See "[Frequency Resolution - Sweep Points and Scaling](#)" on page 391.

If the distance between two sweep points is larger than RBW/3, a warning is displayed in the status bar ( "Increase Sweep Points" or "RBW" ).

#### Dwell time

Consider the following when defining the dwell time:

- **Unknown signals:** select a dwell time of at least 1 second to ensure that pulses down to a frequency of 5 Hz are weighted correctly
- **Pulsed signals or signals that fluctuate slowly:** the dwell time must cover at least the time until the first signal peak is measured; can require long dwell time
- **unmodulated signals or signals with a high modulation frequency:** the dwell time must cover at least the time until the first signal peak is measured; usually shorter than for pulsed signals

## 8.3 Receiving Data Input and Providing Data Output

The R&S FPL1000 can analyze signals from different input sources and provide various types of output (such as noise source control signals).

- [Radio Frequency Input](#).....409
- [Power Sensors](#).....411
- [Output Settings](#).....417

### 8.3.1 Radio Frequency Input

**Access:** "Overview" > "Input" > "Input Source" > "Radio Frequency"

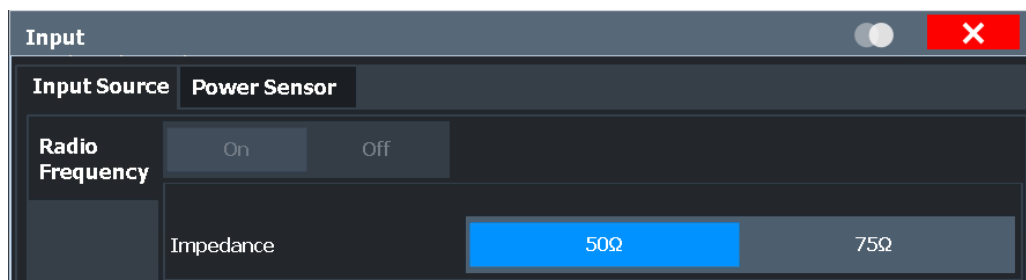



### RF Input Protection

The RF input connector of the R&S FPL1000 must be protected against signal levels that exceed the ranges specified in the data sheet. Therefore, the R&S FPL1000 is equipped with an overload protection mechanism. This mechanism becomes active as soon as the power at the input mixer exceeds the specified limit. It ensures that the connection between RF input and input mixer is cut off.

The RF input connector of the R&S FPL1000 must be protected against signal levels that exceed the ranges specified in the data sheet. Therefore, the R&S FPL1000 is equipped with an overload protection mechanism for DC and signal frequencies up to 30 MHz. This mechanism becomes active as soon as the power at the input mixer exceeds the specified limit. It ensures that the connection between RF input and input mixer is cut off.

When the overload protection is activated, an error message is displayed in the status bar ( "INPUT OVLD" ), and a message box informs you that the RF Input was disconnected. Furthermore, a status bit (bit 3) in the `STAT:QUES:POW` status register is set. In this case you must decrease the level at the RF input connector and then close the message box. Then measurement is possible again. Reactivating the RF input is also possible via the remote command `INPut<ip>:ATTenuation:PROtection:RESet`.

|                             |     |
|-----------------------------|-----|
| Radio Frequency State ..... | 410 |
| Impedance .....             | 410 |
| SAW filter.....             | 410 |

#### Radio Frequency State

Activates input from the "RF Input" connector.

Remote command:

`INPut<ip>:SELEct` on page 743

#### Impedance

For some measurements, the reference impedance for the measured levels of the R&S FPL1000 can be set to 50 Ω or 75 Ω.

Select 75 Ω if the 50 Ω input impedance is transformed to a higher impedance using a 75 Ω adapter of the RAZ type. (That corresponds to 25Ω in series to the input impedance of the instrument.) The correction value in this case is 1.76 dB = 10 log (75Ω/50Ω).

This value also affects the unit conversion (see "Reference Level" on page 429).

Remote command:

`INPut<ip>:IMPedance` on page 743

#### SAW filter

The R&S FPL1000 hardware contains both a wide and a narrow IF path. Depending on the used analysis bandwidth, the R&S FPL1000 determines which IF path to use automatically. The wide IF path allows for a smoother signal at the center frequency, while the narrow IF path suppresses possibly distorting signals further away from the center frequency. Using this setting, you can affect which IF path is used.

"Auto" The R&S FPL1000 determines which IF path to use automatically, depending on the used analysis bandwidth.

"Off" The wide IF path is always used.

Remote command:

`INPut<ip>:FILTer:SAW` on page 742

### 8.3.2 Power Sensors

The R&S FPL1000 can also analyze data from a connected power sensor.



The "Sensor" connector is provided by the "Additional Interfaces" option R&S FPL1-B5. Additionally, the power sensor measurement requires the option R&S FPL1-K9.

- [Basics on Power Sensors](#)..... 411
- [Power Sensor Settings](#).....412
- [How to Work With a Power Sensor](#).....415

#### 8.3.2.1 Basics on Power Sensors

For precise power measurement, up to 4 power sensors can be connected to the instrument via the optional power sensor interface (on the rear panel) or the USB connectors. Both manual operation and remote control are supported.



For a detailed list of supported sensors, see the data sheet.

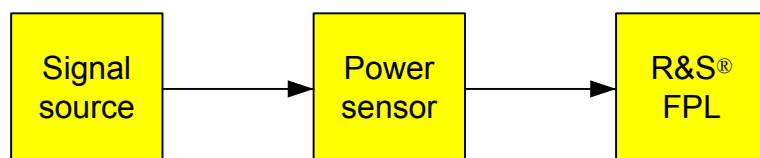

Figure 8-38: Power sensor support – standard test setup



#### Using the power sensor with several applications

The power sensor cannot be used from the R&S FPL1000 firmware and the R&S Power Viewer Plus (virtual power meter for displaying results of the R&S NRP power sensors) simultaneously.

#### Result display

The results of the power sensor measurements are displayed in the marker table. For each power sensor, a row is inserted. The sensor index is indicated in the "Type" column.

| 2 Marker Table |     |     |            |         |                   |                 |
|----------------|-----|-----|------------|---------|-------------------|-----------------|
| Type           | Ref | Trc | X-Value    | Y-Value | Function          | Function Result |
| PWR1           |     |     | -70.00 dBm |         | PWR123456 NRP-Z81 |                 |
| PWR2           |     |     | -70.00 dBm |         | PWR111111 NRP-Z11 |                 |

### 8.3.2.2 Power Sensor Settings

Access: "Overview" > "Input" > "Power Sensor" tab



The power sensor measurement requires the option R&S FPL1-K9.

Each sensor is configured on a separate tab.

- State ..... 412
- Continuous Value Update ..... 413
- Select ..... 413
- Zeroing Power Sensor ..... 413
- Frequency Manual ..... 413
- Frequency Coupling ..... 413
- Unit/Scale ..... 414
- Meas Time/Average ..... 414
- Setting the Reference Level from the Measurement Meas -> Ref ..... 414
- Reference Value ..... 414
- Use Ref Level Offset ..... 414
- Average Count ( Number of Readings ) ..... 415
- Duty Cycle ..... 415

#### State

Switches the power measurement for all power sensors on or off. Note that in addition to this general setting, each power sensor can be activated or deactivated individually by the [Select](#) setting on each tab. However, the general setting overrides the individual settings.

Remote command:

[\[SENSe:\] PMETer<p>\[:STATe\]](#) on page 751

### Continuous Value Update

If activated, the power sensor data is updated continuously during a sweep with a long sweep time, and even after a single sweep has completed.

This function cannot be activated for individual sensors.

Remote command:

[\[SENSe:\] PMETer<p>:UPDate\[:STATe\]](#) on page 751

### Select

Selects the individual power sensor for usage if power measurement is generally activated ( [State](#) function).

The detected **serial numbers** of the power sensors connected to the instrument are provided in a selection list. For each of the four available power sensor indexes ( "Power Sensor 1" ... "Power Sensor 4" ), which correspond to the tabs in the configuration dialog, one of the detected serial numbers can be assigned. The physical sensor is thus assigned to the configuration setting for the selected power sensor index.

By default, serial numbers not yet assigned are automatically assigned to the next free power sensor index for which "Auto Assignment" is selected.

Alternatively, you can assign the sensors manually by deactivating the "Auto" option and selecting a serial number from the list.

Remote command:

[\[SENSe:\] PMETer<p>\[:STATe\]](#) on page 751

[SYSTem:COMMunicate:RDEvice:PMETer<p>:DEFine](#) on page 745

[SYSTem:COMMunicate:RDEvice:PMETer<p>:CONFigure:AUTO\[:STATe\]](#)  
on page 744

[SYSTem:COMMunicate:RDEvice:PMETer<p>:COUNT?](#) on page 745

### Zeroing Power Sensor

Starts zeroing of the power sensor.

For details on the zeroing process refer to ["How to Zero the Power Sensor"](#) on page 416.

Remote command:

[CALibration:PMETer<p>:ZERO:AUTO ONCE](#) on page 746

### Frequency Manual

Defines the frequency of the signal to be measured. The power sensor has a memory with frequency-dependent correction factors. This allows extreme accuracy for signals of a known frequency.

Remote command:

[\[SENSe:\] PMETer<p>:FREQuency](#) on page 749

### Frequency Coupling

Selects the coupling option. The frequency can be coupled automatically to the center frequency of the instrument or to the frequency of marker 1.

Remote command:

[SENSe:] PMETer<p>:FREQuency:LINK on page 749

### Unit/Scale

Selects the unit with which the measured power is to be displayed. Available units are dBm, dB, W and %.

If dB or % is selected, the display is relative to the reference value that is defined with either the "Meas -> Ref" setting or the "Reference Value" setting.

Remote command:

UNIT<n>:PMETer<p>:POWer on page 752

UNIT<n>:PMETer<p>:POWer:RATio on page 752

### Meas Time/Average

Selects the measurement time or switches to manual averaging mode. In general, results are more precise with longer measurement times. The following settings are recommended for different signal types to obtain stable and precise results:

|          |                                                                                                                                                                     |
|----------|---------------------------------------------------------------------------------------------------------------------------------------------------------------------|
| "Short"  | Stationary signals with high power (> -40dBm), because they require only a short measurement time and short measurement time provides the highest repetition rates. |
| "Normal" | Signals with lower power or modulated signals                                                                                                                       |
| "Long"   | Signals at the lower end of the measurement range (<-50 dBm) or Signals with lower power to minimize the influence of noise                                         |
| "Manual" | Manual averaging mode. The average count is set with the <a href="#">Average Count ( Number of Readings )</a> setting.                                              |

Remote command:

[SENSe:] PMETer<p>:MTIME on page 749

[SENSe:] PMETer<p>:MTIME:AVERage[:STATe] on page 750

### Setting the Reference Level from the Measurement Meas -> Ref

Sets the currently measured power as a reference value for the relative display. The reference value can also be set manually via the [Reference Value](#) setting.

Remote command:

CALCulate<n>:PMETer<p>:RELative[:MAGNitude]:AUTO ONCE on page 747

### Reference Value

Defines the reference value in dBm used for relative power meter measurements.

Remote command:

CALCulate<n>:PMETer<p>:RELative[:MAGNitude] on page 747

### Use Ref Level Offset

If activated, takes the reference level offset defined for the analyzer into account for the measured power (see "[Shifting the Display \( Offset \)](#)" on page 430).

If deactivated, takes no offset into account.

Remote command:

[SENSe:] PMETer<p>:ROFFset[:STATe] on page 751

**Average Count ( Number of Readings )**

Defines the number of readings (averages) to be performed after a single sweep has been started. This setting is only available if manual averaging is selected ( [Meas Time/Average](#) setting).

The values for the average count range from 0 to 256 in binary steps (1, 2, 4, 8, ...). For average count = 0 or 1, one reading is performed. The general averaging and sweep count for the trace are independent from this setting.

Results become more stable with extended average, particularly if signals with low power are measured. This setting can be used to minimize the influence of noise in the power sensor measurement.

Remote command:

[\[SENSe:\] PMETer<p>:MTIME:AVERage:COUNT](#) on page 750

**Duty Cycle**

Sets the duty cycle to a percent value for the correction of pulse-modulated signals and activates the duty cycle correction. With the correction activated, the sensor calculates the signal pulse power from this value and the mean power.

Remote command:

[\[SENSe:\] PMETer<p>:DCYCLE\[:STATe\]](#) on page 748

[\[SENSe:\] PMETer<p>:DCYCLE:VALue](#) on page 748

**8.3.2.3 How to Work With a Power Sensor**

The following step-by-step instructions demonstrate how to set up a power sensor. For details on individual functions and settings see [Chapter 8.3.2.2, "Power Sensor Settings"](#), on page 412.

The remote commands required to perform these tasks are described in [Chapter 9.8.5.2, "Working with Power Sensors"](#), on page 744.

**How to Set Up a Power Sensor**

Up to 4 external power sensors can be configured separately and used for precise power measurement. All power sensors can be activated and deactivated individually.

The following procedure describes in detail how to configure and activate power sensors.

1. To display the "Power Sensor" tab of the "Input" dialog box, do one of the following:
  - Select "Input" from the "Overview" .
  - Select the [INPUT/OUTPUT] key and then the "Power Sensor Config" softkey.
2. Select the tab for the power sensor index you want to configure, e.g. "Power Sensor 1" .
3. Press "Select" to analyze the power sensor data according to the current configuration when power measurement is activated.
4. From the selection list with serial numbers of connected power sensors, select the sensor you want to configure.

To have newly connected power sensors assigned to a tab automatically (default), select "Auto" .

5. Define the frequency of the signal whose power you want to measure.
  - a) To define the frequency manually, select "Frequency Manual" and enter a frequency.
  - b) To determine the frequency automatically, select "Frequency Coupling" and then either "Center" , to use the center frequency, or "Marker" , to use the frequency defined by marker 1.
6. Select the unit for the power result display.
7. Select the measurement time for which the average is calculated, or define the number of readings to average. To define the number of readings to be taken into account manually, select "Manual" and enter the number in the "Number of Readings" field.
8. To activate the duty cycle correction, select "DutyCycle" and enter a percentage as the correction value.
9. If you selected "dB" or "%" as units (relative display), define a reference value:
  - a) To set the currently measured power as a reference value, press the "Meas -> Ref" button.
  - b) Alternatively, enter a value manually in the "Reference Value" field.
  - c) Optionally, select the "Use Ref Level Offset" option to take the reference level offset set for the analyzer into account for the measured power.
10. If necessary, repeat steps 3-10 for another power sensor.
11. Set the "Power Sensor State" at the top of the "Power Sensor" tab to "On" to activate power measurement for the selected power sensors.

The results of the power measurement are displayed in the marker table (Function: "Sensor <1...4>" ).

### How to Zero the Power Sensor

1. To display the "Power Sensor" tab of the "Input" dialog box, do one of the following:
  - Select "Input" from the "Overview" .
  - Select the [INPUT/OUTPUT] key and then the "Power Sensor Config" softkey.
2. Select the tab that is assigned to the power sensor you want to zero.
3. Press the "Zeroing Power Sensor" button.

A dialog box is displayed that prompts you to disconnect all signals from the input of the power sensor.
4. Disconnect all signals sending input to the power sensor and press [ENTER] to continue.
5. Wait until zeroing is complete.



A corresponding message is displayed.

### 8.3.3 Output Settings

**Access:** "Overview" > "Output"

The R&S FPL1000 can provide signals to different output connectors.

These connectors are only available if the R&S FPL1-B5 option is installed.

For details on connectors, refer to the R&S FPL1000 Getting Started manual, "Front / Rear Panel View" chapters.

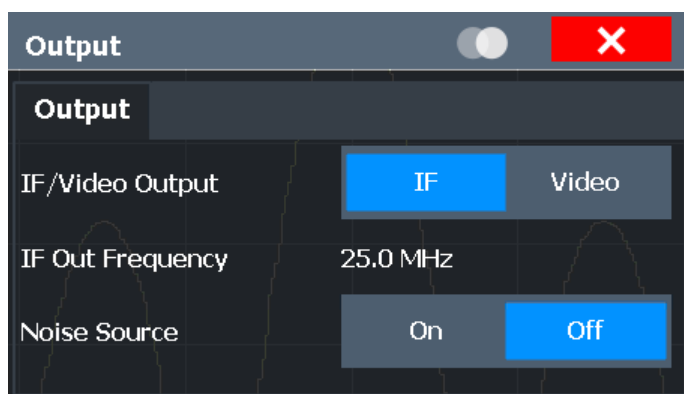

Data Output.....417  
 Noise Source Control.....418

#### Data Output

Defines the type of signal available at one of the output connectors of the R&S FPL1000.

This connector is only available if the R&S FPL1-B5 option is installed.

"IF" The measured IF value is provided at the IF/VIDEO output connector. The output is provided at a fixed frequency of 25 MHz. IF and video output is only available in the time domain (zero span).

"Video" The displayed video signal (i.e. the filtered and detected IF signal, 200mV) is available at the IF/VIDEO output connector. This setting is required to provide demodulated audio frequencies at the output. It is not available for frequency sweeps or I/Q measurements. The **video output** is a signal of 1 V. It can be used, for example, to control demodulated audio frequencies.

Remote command:

`OUTPut<up>:IF[:SOURce]` on page 753

`OUTPut<up>:IF:IFFrequency` on page 753

`SYSTem:SPEaker:VOLume` on page 755

`SYSTem:SPEaker[:STATe]` on page 755

**Noise Source Control**

The R&S FPL1000 provides a connector ("NOISE SOURCE CONTROL") with a 28 V voltage supply for an external noise source. By switching the supply voltage for an external noise source on or off in the firmware, you can enable or disable the device as required.

This connector is only available if the R&S FPL1-B5 option is installed.

External noise sources are useful when you are measuring power levels that fall below the noise floor of the R&S FPL1000 itself, for example when measuring the noise level of an amplifier.

In this case, you can first connect an external noise source (whose noise power level is known in advance) to the R&S FPL1000 and measure the total noise power. From this value you can determine the noise power of the R&S FPL1000. Then when you measure the power level of the actual DUT, you can deduct the known noise level from the total power to obtain the power level of the DUT.

Remote command:

[DIAGnostic:SERVice:NSource](#) on page 753

## 8.4 Frequency and Span Configuration

The frequency and span settings define the scope of the signal and spectrum to be analyzed with the R&S FPL1000.

- [Impact of the Frequency and Span Settings](#)..... 418
- [Frequency and Span Settings](#).....420
- [Keeping the Center Frequency Stable - Signal Tracking](#)..... 424
- [How To Define the Frequency Range](#)..... 425
- [How to Move the Center Frequency through the Frequency Range](#)..... 425

### 8.4.1 Impact of the Frequency and Span Settings

Some background knowledge on the impact of the described settings is provided here for a better understanding of the required configuration.

- [Defining the Scope of the Measurement - Frequency Range](#)..... 418
- [Stepping Through the Frequency Range - Center Frequency Stepsize](#)..... 419
- [Coping with Large Frequency Ranges - Logarithmic Scaling](#)..... 419

#### 8.4.1.1 Defining the Scope of the Measurement - Frequency Range

The frequency range defines the scope of the signal and spectrum to be analyzed. It can either be defined as a span around a center frequency, or as a range from a start to a stop frequency. Furthermore, the full span comprising the entire possible frequency range can be selected, or a zero span. The full span option allows you to perform an overview measurement over the entire span. Using the "Last Span" function you can easily switch back to the detailed measurement of a specific frequency range.

For sinusoidal signals, the center frequency can be defined automatically by the R&S FPL1000 as the highest frequency level in the frequency span (see "[Adjusting the Center Frequency Automatically \( Auto Frequency \)](#)" on page 462).

#### 8.4.1.2 Stepping Through the Frequency Range - Center Frequency Stepsize

Using the arrow keys you can move the center frequency in discrete steps through the available frequency range. The step size by which the center frequency is increased or decreased is defined by the "Center Frequency Stepsize" .



The "Center Frequency Stepsize" also defines the step size by which the value is increased or decreased when you use the rotary knob to change the center frequency; however, the **rotary knob** moves in steps of only **1/10 of the "Center Frequency Stepsize"** to allow for a more precise setting.

By default, the step size is set in relation to the selected span or resolution bandwidth (for zero span measurements). In some cases, however, it may be useful to set the step size to other values.



For example, to analyze signal harmonics, you can define the step size to be equal to the center frequency. In this case, each stroke of the arrow key selects the center frequency of another harmonic. Similarly, you can define the step size to be equal to the current marker frequency.

#### 8.4.1.3 Coping with Large Frequency Ranges - Logarithmic Scaling

In a linear display, the frequencies are distributed linearly across the x-axis. That means the entire frequency range is divided by the number of sweep points, and the distance between sweep points is equal. Linear scaling is useful to determine precise frequencies within a small range.



*Figure 8-39: Linear x-axis scaling: the distance between the sweep points is equal, e.g. 200 kHz*

However, if high and low frequencies appear in the same display, it is difficult to determine individual frequencies precisely or to distinguish frequencies that are close together.

In a logarithmic display, lower frequencies are distributed among a much larger area of the display, while high frequencies are condensed to a smaller area. Now it is much easier to distinguish several lower frequencies, as they are spread over a wider area. Logarithmic scaling is useful for overview measurements when a large frequency range must be displayed in one diagram.

However, with logarithmic scaling, the frequency resolution between two sweep points deteriorates with higher frequencies.



**Figure 8-40: Logarithmic x-axis scaling: the distance between sweep points is variable**

In the spectrum from 10 Hz to 100 Hz, the distance is a few Hz. Between 100 MHz and 1 GHz, the distance is several MHz.

Thus, for logarithmic x-axis scaling, the number of sweep points must be sufficiently high in order to distinguish high frequencies precisely. The resolution bandwidth should cover at least one sweep point (that means: the distance between two sweep points should not exceed the RBW). If this condition is not met, signals or interferers could be missed, especially narrowband interferers.

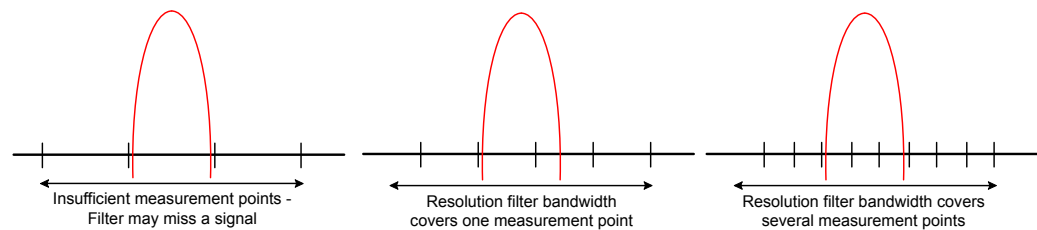

## 8.4.2 Frequency and Span Settings

**Access:** "Overview" > "Frequency"

For more information see [Chapter 8.4.4, "How To Define the Frequency Range"](#), on page 425.

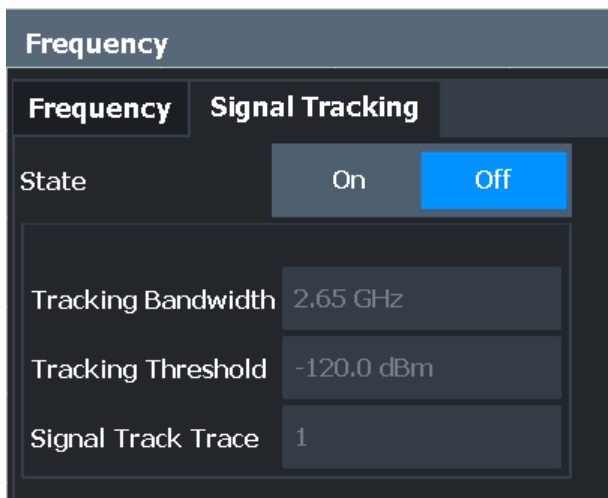
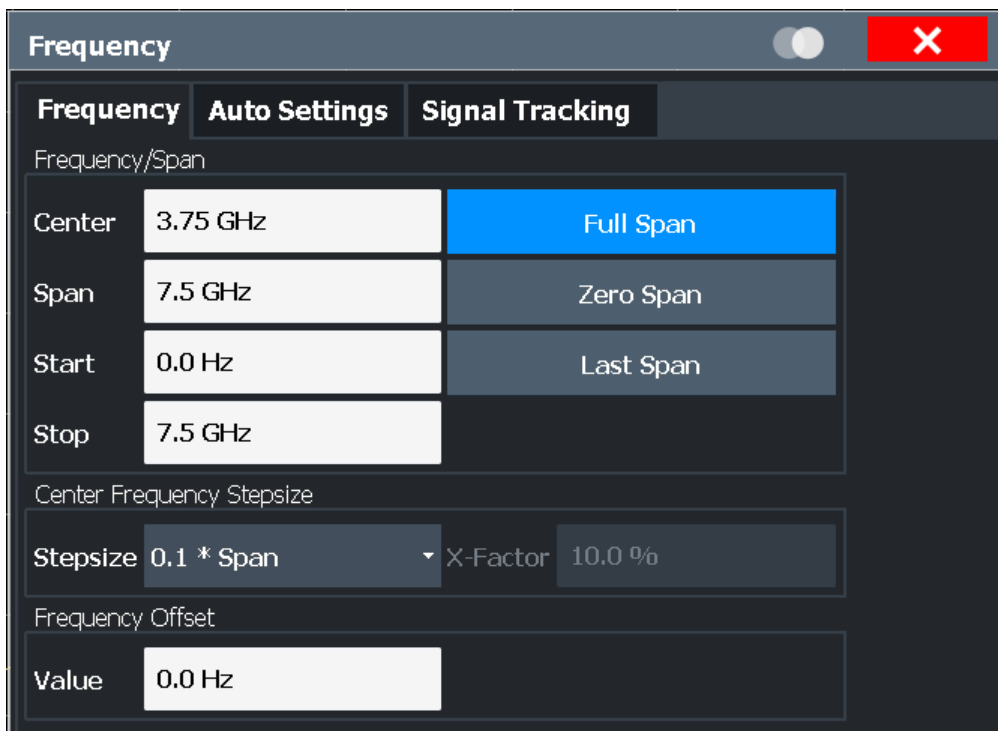

"Auto Settings" are described in [Chapter 8.8, "Adjusting Settings Automatically"](#), on page 461.

Signal Tracking is described in [Chapter 8.4.3, "Keeping the Center Frequency Stable - Signal Tracking"](#), on page 424.

|                                        |     |
|----------------------------------------|-----|
| <a href="#">Center Frequency</a> ..... | 422 |
| <a href="#">Span</a> .....             | 422 |
| <a href="#">Start / Stop</a> .....     | 422 |
| <a href="#">Full Span</a> .....        | 422 |
| <a href="#">Zero Span</a> .....        | 423 |

|                                 |     |
|---------------------------------|-----|
| Last Span .....                 | 423 |
| Center Frequency Stepsize ..... | 423 |
| Frequency Offset .....          | 424 |

### Center Frequency

Defines the center frequency of the signal in Hertz.

The allowed range of values for the center frequency depends on the frequency span.

$$\text{span} > 0: \text{span}_{\min}/2 \leq f_{\text{center}} \leq f_{\text{max}} - \text{span}_{\min}/2$$

$$\text{zero span: } 0 \text{ Hz} \leq f_{\text{center}} \leq f_{\text{max}}$$

$f_{\text{max}}$  and  $\text{span}_{\min}$  depend on the instrument and are specified in the data sheet.

Remote command:

[SENSe:] FREQuency:CENTer on page 713

### Span

Defines the frequency span. The center frequency is kept constant. The following range is allowed:

$$\text{span} = 0: 0 \text{ Hz}$$

span >0:

$$\text{span}_{\min} \leq f_{\text{span}} \leq f_{\text{max}}$$

$f_{\text{max}}$  and  $\text{span}_{\min}$  are specified in the data sheet.

For more information see [Chapter 8.4.1.1, "Defining the Scope of the Measurement - Frequency Range"](#), on page 418.

Remote command:

[SENSe:] FREQuency:SPAN on page 715

### Start / Stop

Defines the start and stop frequencies.

The following range of values is allowed:

$$f_{\min} \leq f_{\text{start}} \leq f_{\text{max}} - \text{span}_{\min}$$

$$f_{\min} + \text{span}_{\min} \leq f_{\text{stop}} \leq f_{\text{max}}$$

$f_{\min}$ ,  $f_{\text{max}}$  and  $\text{span}_{\min}$  are specified in the data sheet.

Remote command:

[SENSe:] FREQuency:START on page 716

[SENSe:] FREQuency:STOP on page 716

### Full Span

Sets the span to the full frequency range of the R&S FPL1000 specified in the data sheet. This setting is useful for overview measurements.

Remote command:

[SENSe:] FREQuency:SPAN:FULL on page 716

**Zero Span**

Sets the span to 0 Hz (zero span). The x-axis becomes the time axis with the grid lines corresponding to 1/10 of the current sweep time ( "SWT" ).

For details see [Chapter 8.2.1, "Basic Measurements"](#), on page 240.

Remote command:

FREQ:SPAN 0Hz, see [\[SENSe:\]FREQUENCY:SPAN](#) on page 715

**Last Span**

Sets the span to the previous value. With this function you can switch between an overview measurement and a detailed measurement quickly.

Remote command:

[\[SENSe:\]FREQUENCY:SPAN](#) on page 715

**Center Frequency Stepsize**

Defines the step size by which the center frequency is increased or decreased when the arrow keys are pressed. When you use the rotary knob the center frequency changes in much smaller steps (1/10 the size as for the arrow keys).

The step size can be coupled to the span (span > 0) or the resolution bandwidth (span = 0), or it can be manually set to a fixed value.

For more details see [Chapter 8.4.1.2, "Stepping Through the Frequency Range - Center Frequency Stepsize"](#), on page 419.

"0.1 \* Span" / "0.1 \* RBW" Sets the step size for the center frequency to 10 % of the span / RBW.

This is the default setting.

"0.5 \* Span" / "0.5 \* RBW" Sets the step size for the center frequency to 50 % of the span / RBW.

"x \* Span" / "x \* RBW" Sets the step size for the center frequency to a manually defined factor of the span / RBW. The "X-Factor" defines the percentage of the span / RBW.

Values between 1 and 100 % in steps of 1 % are allowed. The default setting is 10 %.

"= Center" Sets the step size to the value of the center frequency and removes the coupling of the step size to span or resolution bandwidth. The used value is indicated in the "Value" field.

"= Marker" This setting is only available if a marker is active. Sets the step size to the value of the current marker and removes the coupling of the step size to span or resolution bandwidth. The used value is indicated in the "Value" field.

"Manual" Defines a fixed step size for the center frequency. Enter the step size in the "Value" field.

Remote command:

[\[SENSe:\]FREQUENCY:CENTER:STEP:LINK](#) on page 714

[\[SENSe:\]FREQUENCY:CENTER:STEP:LINK:FACTOR](#) on page 715

[\[SENSe:\]FREQUENCY:CENTER:STEP](#) on page 714

### Frequency Offset

Shifts the displayed frequency range along the x-axis by the defined offset.

This parameter has no effect on the instrument's hardware, or on the captured data or on data processing. It is simply a manipulation of the final results in which absolute frequency values are displayed. Thus, the x-axis of a spectrum display is shifted by a constant offset if it shows absolute frequencies. However, if it shows frequencies relative to the signal's center frequency, it is not shifted.

A frequency offset can be used to correct the display of a signal that is slightly distorted by the measurement setup, for example.

The allowed values range from -100 GHz to 100 GHz. The default setting is 0 Hz.

Remote command:

[SENSe:]FREQuency:OFFSet on page 715

## 8.4.3 Keeping the Center Frequency Stable - Signal Tracking

If the signal drifts on the display but you want to keep the center frequency on the signal peak, the center frequency can be adjusted automatically using **signal tracking**. In this case, the signal trace is surveyed in a specified bandwidth around the expected center frequency. After each sweep, the center frequency is set to the maximum signal found within the searched bandwidth. If no maximum signal above a defined threshold value is found in the searched bandwidth, the center frequency remains unchanged. The search bandwidth and the threshold value are shown in the diagram by red lines which are labeled as "TRK".



### Signal Tracking

**Access:** "Overview" > "Frequency" > "Signal Tracking" tab

Defines the settings for signal tracking. These settings are only available for spans > 0.



For more details see [Chapter 8.4.3, "Keeping the Center Frequency Stable - Signal Tracking"](#), on page 424.

If activated, after each sweep, the center frequency is set to the maximum level of the specified "Signal Track Trace" found within the searched "Tracking Bandwidth" .

If the signal level does not pass the "Tracking Threshold" , the center frequency is not changed.

Remote command:

[CALCulate<n>:MARKer<m>:FUNCTION:STRack\[:STATe\]](#) on page 720

[CALCulate<n>:MARKer<m>:FUNCTION:STRack:BANDwidth](#) on page 720

[CALCulate<n>:MARKer<m>:FUNCTION:STRack:THReshold](#) on page 721

[CALCulate<n>:MARKer<m>:FUNCTION:STRack:TRACe](#) on page 721

#### 8.4.4 How To Define the Frequency Range

The following step-by-step instructions demonstrate how to configure the frequency and span settings. For details on individual functions and settings see [Chapter 8.4.2, "Frequency and Span Settings"](#), on page 420.

The remote commands required to perform these tasks are described in [Chapter 9.8.1, "Defining the Frequency and Span"](#), on page 712.

##### To configure the frequency and span

Frequency and span settings can be configured via the "Frequency" dialog box. Signal tracking is configured in the "Signal Tracking" tab of this dialog box.

1. To display the "Frequency" dialog box, do one of the following:
  - Select "Frequency" from the "Overview" .
  - Select the [FREQ] key and then the "Frequency Config" softkey.
  - Select the [SPAN] key and then the "Frequency Config" softkey.
2. Define the frequency range using one of the following methods:
  - Define the "Center Frequency" and "Span" .
  - Define the "Start Frequency" and "Stop Frequency" .
  - To perform a measurement in the time domain, define the "Center Frequency" and select the "Zero Span" button.
  - To perform a measurement over the entire available frequency range, select the "Full Span" button.
  - To return to the previously set frequency range, select the "Last Span" button.

#### 8.4.5 How to Move the Center Frequency through the Frequency Range

In some cases it may be useful to move the center frequency through a larger frequency range, for example from one harmonic to another.

1. In the "Frequency" dialog box, define the "Center Frequency Stepsize" . This is the size by which the center frequency is to be increased or decreased in each step.

Enter a manual or relative value, or set the step size to the current center frequency or marker value. To move from one harmonic to the next, use the center frequency or marker value.

2. Select the "Center Frequency" dialog field.
3. Use the arrow keys to move the center frequency in discrete steps through the available frequency range.

## 8.5 Amplitude and Vertical Axis Configuration

In the Spectrum application, measurement results usually consist of the measured signal levels (amplitudes) displayed on the vertical (y-)axis for the determined frequency spectrum or for the measurement time (horizontal, x-axis). The settings for the vertical axis, regarding amplitude and scaling, are described here.



"Auto Settings" are described in [Chapter 8.8, "Adjusting Settings Automatically"](#), on page 461.

- [Impact of the Vertical Axis Settings](#).....426
- [Amplitude Settings](#)..... 429
- [Scaling the Y-Axis](#)..... 432
- [How to Optimize the Amplitude Display](#).....434

### 8.5.1 Impact of the Vertical Axis Settings

Some background knowledge on the impact of the described settings is provided here for a better understanding of the required configuration.

- [Reference Level](#).....426
- [RF Attenuation](#)..... 428
- [Scaling](#)..... 428

#### 8.5.1.1 Reference Level

The reference level value is the maximum value the AD converter can handle without distortion of the measured value. Signal levels above this value will not be measured correctly, which is indicated by the "IF Overload" status display.

Internally, the reference level is also used to determine the optimum hardware settings for the R&S FPL1000. The defined reference level should correspond with the maximum expected RF input level.



When determining the expected input level, consider that the power from *all* input signals contribute to the total power. The reference level must be higher than the total power from all signals.

The optimum reference level for the current measurement settings can be set automatically by the R&S FPL1000 (see " [Reference Level](#) " on page 429).

The reference level determines the amplitude represented by the topmost grid line in the display. When you change the reference level, the measurement is not restarted; the results are merely shifted in the display. Only if the reference level changes due to a coupled RF attenuation (see " [Attenuation Mode / Value](#) " on page 431), the measurement is restarted.

In general, the R&S FPL1000 measures the signal voltage at the RF input. The level display is calibrated in RMS values of an unmodulated sine wave signal. In the default state, the level is displayed at a power of 1 mW (= dBm). Via the known input impedance, conversion to other units is possible.

### Reference level offset

If the signal is attenuated or amplified before it is fed into the R&S FPL1000, you can define an (arithmetic) offset to the reference level so the application shows correct power results. All displayed power level results are shifted by this value, and the scaling of the y-axis is changed accordingly.

To determine the required offset, consider the external attenuation or gain applied to the input signal. For attenuation, define a positive offset so the R&S FPL1000 increases the displayed power values.

If an external gain is applied, define a negative offset so the R&S FPL1000 decreases the displayed power values.

Note, however, that the *internal* reference level (used to adjust the hardware settings to the expected signal optimally) ignores any "Reference Level Offset" . Thus, it is important to keep in mind the actual power level the R&S FPL1000 must handle, and not to rely on the displayed reference level.

internal reference level = displayed reference level - offset

### Example

1. The initial reference level is 2 dBm with no offset.

Both the displayed reference level and the internal reference level are 2 dBm.

2. An offset of 3 dB is defined.

The displayed reference level is adjusted to 5 dBm.

The internal reference level remains at 2 dBm.

$(5 \text{ dBm (displayed ref level)} - 3 \text{ dB (offset)}) = 2 \text{ dBm}$

3. Now the user decreases the reference level to 1 dBm.

The displayed reference level is adjusted to 1 dBm.

The internal reference level is adjusted to:

$1 \text{ dBm (displayed ref level)} - 3 \text{ dB (offset)} = -2 \text{ dBm}$ .

### 8.5.1.2 RF Attenuation

The attenuation is meant to protect the input mixer from high RF input levels. The level at the input mixer is determined by the set RF attenuation according to the formula:

$$\text{level}_{\text{mixer}} = \text{level}_{\text{input}} - \text{RF attenuation}$$

The maximum mixer level allowed is -13 dBm.

Mixer levels above this value may lead to incorrect measurement results, which is indicated by the "RF Overload" status display. Furthermore, higher input levels may damage the instrument. Therefore, the required RF attenuation is determined automatically according to the reference level by default.

High attenuation levels also avoid intermodulation. On the other hand, attenuation must be compensated for by re-amplifying the signal levels after the mixer. Thus, high attenuation values cause the inherent noise (i.e. the noise floor) to rise and the sensitivity of the analyzer decreases.

The sensitivity of a signal analyzer is directly influenced by the selected RF attenuation. The highest sensitivity is obtained at an RF attenuation of 0 dB. Each additional 10 dB step reduces the sensitivity by 10 dB, i.e. the displayed noise is increased by 10 dB. To measure a signal with an improved signal-to-noise ratio, decrease the RF attenuation.



For ideal sinusoidal signals, the displayed signal level is independent of the RF attenuation.

Depending on the type of measurement you must find a compromise between a low noise floor and high intermodulation levels, and protecting the instrument from high input levels. You achieve this best by letting the R&S FPL1000 determine the optimum level automatically (see "[Attenuation Mode / Value](#)" on page 431).

### 8.5.1.3 Scaling

In a linear display, the measurement values are distributed linearly throughout the grid. That means the entire range of measured values is divided by the number of rows in the grid (10) and each row corresponds to 1/10 of the total range. Linear scaling is useful to determine precise levels for a small range of values. However, if large and small values appear in the same display, it is difficult to determine individual values precisely or to distinguish values that are close together.

In a logarithmic display, smaller values are distributed among a much larger area of the display, while large values are condensed to a smaller area. Now it is much easier to distinguish several lower values, as they are spread over a wider area. Logarithmic scaling is useful when large ranges of values must be combined in one display. Logarithmic scaling is best applied to measurement values in logarithmic units (dB, dBm etc.).

In addition to linear or logarithmic scaling, the vertical axis can be set to display either absolute or relative values. Absolute values show the measured levels, while relative values show the difference between the measured level and the defined reference

level. Relative values are indicated in percent for linear scaling, and in dB for logarithmic scaling.

### 8.5.2 Amplitude Settings

**Access:** "Overview" > "Amplitude"

Amplitude settings determine how the R&S FPL1000 must process or display the expected input power levels.

The remote commands required to define these settings are described in [Chapter 9.8.3.1, "Amplitude Settings"](#), on page 729.

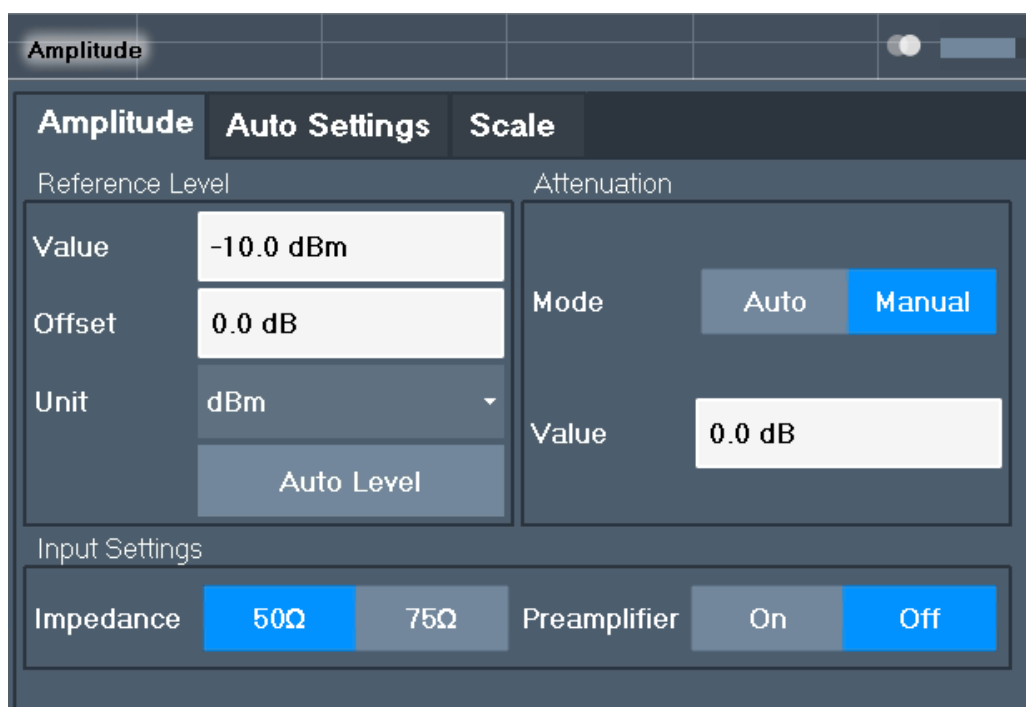

- Reference Level ..... 429
  - └ Shifting the Display ( Offset )..... 430
  - └ Unit ..... 430
  - └ Setting the Reference Level Automatically ( Auto Level )..... 431
- Attenuation Mode / Value ..... 431
- Impedance ..... 431
- Preamplifier ..... 432

**Reference Level**

Defines the expected maximum input signal level. Signal levels above this value may not be measured correctly, which is indicated by the "IF Overload" status display ( "OVLD" for analog baseband or digital baseband input).

Defines the expected maximum reference level. Signal levels above this value may not be measured correctly. This is indicated by an "IF Overload" status display.

The reference level can also be used to scale power diagrams; the reference level is then used as the maximum on the y-axis.

Since the hardware of the R&S FPL1000 is adapted according to this value, it is recommended that you set the reference level close above the expected maximum signal level. Thus you ensure an optimum measurement (no compression, good signal-to-noise ratio).

For details, see [Chapter 8.5.1.1, "Reference Level"](#), on page 426.

Remote command:

`DISPlay[:WINDow<n>]:TRACe<t>:Y[:SCALe]:RLEVel` on page 730

### Shifting the Display ( Offset ) ← Reference Level

Defines an arithmetic level offset. This offset is added to the measured level. In some result displays, the scaling of the y-axis is changed accordingly.

Define an offset if the signal is attenuated or amplified before it is fed into the R&S FPL1000 so the application shows correct power results. All displayed power level results are shifted by this value.

The setting range is  $\pm 200$  dB in 0.01 dB steps.

Note, however, that the *internal* reference level (used to adjust the hardware settings to the expected signal) ignores any "Reference Level Offset". Thus, it is important to keep in mind the actual power level the R&S FPL1000 must handle. Do not rely on the displayed reference level (internal reference level = displayed reference level - offset).

For details, see ["Reference level offset"](#) on page 427.

Remote command:

`DISPlay[:WINDow<n>]:TRACe<t>:Y[:SCALe]:RLEVel:OFFSet` on page 730

### Unit ← Reference Level

The R&S FPL1000 measures the signal voltage at the RF input.

In the default state, the level is displayed at a power level of 1 mW (= dBm). Via the known input impedance (50  $\Omega$  or 75  $\Omega$ , see [" Impedance "](#) on page 410), conversion to other units is possible.

The following units are available and directly convertible:

- dBm
- dBmV
- dB $\mu$ V
- dB $\mu$ A
- dBpW
- Volt
- Ampere
- Watt

Additional units available only for installed R&S FPL1-K54 (EMI measurements) option:

- dBmV/MHz (normalized to 1 MHz)
- dB $\mu$ V/MHz (normalized to 1 MHz)
- dB $\mu$ V/mMHz (normalized to 1 MHz)  
(only available for active transducers with dB $\mu$ V/m values)
- dB $\mu$ A/MHz (normalized to 1 MHz)
- dB $\mu$ A/mMHz (normalized to 1 MHz)

(only available for active transducers with dB $\mu$ A/m values)

- dBpW/MHz (normalized to 1 MHz)

Remote command:

[INPut<ip>:IMPedance](#) on page 743

[CALCulate<n>:UNIT:POWer](#) on page 729

### Setting the Reference Level Automatically ( Auto Level ) ← Reference Level

Automatically determines a reference level which ensures that no overload occurs at the R&S FPL1000 for the current input data. At the same time, the internal attenuators are adjusted so the signal-to-noise ratio is optimized, while signal compression and clipping are minimized.

To determine the required reference level, a level measurement is performed on the R&S FPL1000.

If necessary, you can optimize the reference level further. Decrease the attenuation level manually to the lowest possible value before an overload occurs, then decrease the reference level in the same way.

You can change the measurement time for the level measurement if necessary (see "[Changing the Automatic Measurement Time \( Meastime Manual \)](#)" on page 462).

Remote command:

[\[SENSe:\]ADJust:LEVel](#) on page 719

### Attenuation Mode / Value

The RF attenuation can be set automatically as a function of the selected reference level (Auto mode). This ensures that no overload occurs at the RF Input connector for the current reference level. It is the default setting.

In "Manual" mode, you can set the RF attenuation in 5 dB steps down to 0 dB (with option R&S FPL1-B22: in 1 dB steps). Other entries are rounded to the next integer value. The range is specified in the data sheet. If the defined reference level cannot be set for the defined RF attenuation, the reference level is adjusted accordingly and the warning "limit reached" is displayed.

**NOTICE!** Risk of hardware damage due to high power levels. When decreasing the attenuation manually, ensure that the power level does not exceed the maximum level allowed at the RF input, as an overload may lead to hardware damage.

For details, see [Chapter 8.5.1.2, "RF Attenuation"](#), on page 428.

Remote command:

[INPut<ip>:ATTenuation](#) on page 731

[INPut<ip>:ATTenuation:AUTO](#) on page 731

### Impedance

For some measurements, the reference impedance for the measured levels of the R&S FPL1000 can be set to 50  $\Omega$  or 75  $\Omega$ .

Select 75  $\Omega$  if the 50  $\Omega$  input impedance is transformed to a higher impedance using a 75  $\Omega$  adapter of the RAZ type. (That corresponds to 25 $\Omega$  in series to the input impedance of the instrument.) The correction value in this case is 1.76 dB = 10 log (75 $\Omega$ /50 $\Omega$ ).

This value also affects the unit conversion (see "[Reference Level](#)" on page 429).

Remote command:

`INPut<ip>:IMPedance` on page 743

### Preamplifier

If the (optional) internal preamplifier hardware is installed, a preamplifier can be activated for the RF input signal.

You can use a preamplifier to analyze signals from DUTs with low output power.

Note that if an optional external preamplifier is activated, the internal preamplifier is automatically disabled, and vice versa.

The input signal is amplified by 20 dB if the preamplifier option is activated.

Remote command:

`INPut<ip>:GAIN:STATe` on page 732

## 8.5.3 Scaling the Y-Axis

The individual scaling settings that affect the vertical axis are described here.

**Access:** "Overview" > "Amplitude" > "Scale" tab

**Or:** [AMPT] > "Scale Config"

The remote commands required to define these settings are described in [Chapter 9.8.3, "Configuring the Vertical Axis \(Amplitude, Scaling\)"](#), on page 729.

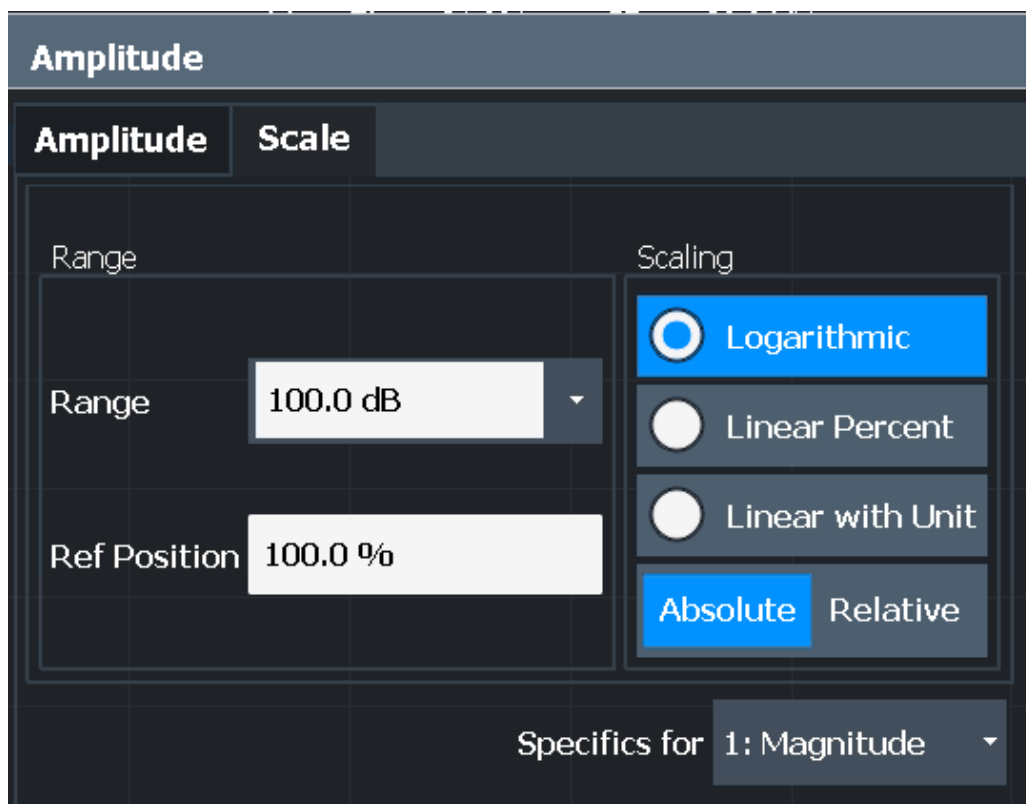



|                          |     |
|--------------------------|-----|
| Range .....              | 433 |
| Ref Level Position ..... | 433 |
| Auto Scale Once .....    | 433 |
| Scaling .....            | 433 |

### Range

Defines the displayed y-axis range in dB.

The default value is 100 dB.

Remote command:

`DISPlay[:WINDow<n>]:TRACe<t>:Y[:SCALe]` on page 732

### Ref Level Position

Defines the reference level position, i.e. the position of the maximum AD converter value on the level axis in %.

0 % corresponds to the lower and 100 % to the upper limit of the diagram.

For spectrograms, this value defines the position of the reference level value within the span covered by the color map. In this case, the value is given in %, where 0 % corresponds to the maximum (right end) and 100 % to the minimum (left end) of the color map.

Remote command:

`DISPlay[:WINDow<n>]:TRACe<t>:Y[:SCALe]:RPOSition` on page 733

### Auto Scale Once

Automatically determines the optimal range and reference level position to be displayed for the current measurement settings.

The display is only set once; it is not adapted further if the measurement settings are changed again.

Remote command:

`DISPlay[:WINDow<n>]:TRACe<t>:Y[:SCALe]:AUTO ONCE` on page 733

### Scaling

Defines the scaling method for the y-axis.

For more information, see [Chapter 8.5.1.3, "Scaling"](#), on page 428.

|                    |                                                                                                                                                                       |
|--------------------|-----------------------------------------------------------------------------------------------------------------------------------------------------------------------|
| "Logarithmic"      | Logarithmic scaling (only available for logarithmic units - dB..., and A, V, Watt)                                                                                    |
| "Linear with Unit" | Linear scaling in the unit of the measured signal                                                                                                                     |
| "Linear Percent"   | Linear scaling in percentages from 0 to 100                                                                                                                           |
| "Absolute"         | The labeling of the level lines refers to the absolute value of the reference level (not available for "Linear Percent" )                                             |
| "Relative"         | The scaling is in dB, relative to the reference level (only available for logarithmic units - dB...). The upper line of the grid (reference level) is always at 0 dB. |

Remote command:

`DISPlay[:WINDow<n>][:SUBWindow<w>]:TRACe<t>:Y:SPACing` on page 734

`DISPlay[:WINDow<n>][:SUBWindow<w>]:TRACe<t>:Y[:SCALE]:MODE`

on page 733

### 8.5.4 How to Optimize the Amplitude Display

This section gives you some advice on how to optimize the display of the measured signal amplitudes depending on the required evaluation.

1. Perform a measurement with the default settings to get an impression of the values to be expected.
2. Use the "Auto Level" function ([AUTO] menu) to optimize the reference level.
3. Use the "AF Auto Scale" function ([AUTO] menu) to optimize the scaling.
4. **To determine a precise level at a specific point in the signal:**
  - Reduce the "Range" of the y-axis to a small area around the required level. If necessary, change the "Ref Level Position" so the required range remains visible.
  - Select "Linear with Unit" scaling.

Now you can set a marker at the point in question and read the result.

5. **To detect a spurious signal close to the noise floor:**
  - Set the "RF Attenuation" to "Manual" mode and reduce the "Value" to lower the noise floor.
  - Select "Relative" - "Logarithmic" scaling.

Now you can determine if any spurious levels of a certain size are visible.

## 8.6 Bandwidth, Filter and Sweep Configuration

The basic bandwidth, filter and sweep settings that apply to most measurements are described here. These parameters define how the data is measured: how much data is collected internally and which filters are used.

- [Impact of the Bandwidth, Filter and Sweep Settings](#).....434
- [Bandwidth, Filter and Sweep Settings](#)..... 440
- [Reference: List of Available RRC and Channel Filters](#)..... 448

### 8.6.1 Impact of the Bandwidth, Filter and Sweep Settings

The bandwidth, filter and sweep settings are closely related and interdependent. The values available for resolution bandwidth and video bandwidth depend on the selected filter type. In addition, these settings have an impact on other measurement parameters. The following equation shows the interdependency of these settings:

$$T_{\text{MIN}} = K * \text{Span} / \text{RBW}^2$$

where K = Filter constant

By default, a Gaussian filter is used. The resolution bandwidth, the video bandwidth and the "Sweep Time" are set automatically according to the set span, and default coupling is used. Thus, the following settings are applied:

$$\text{RBW} = 100 * \text{Span}$$

$$\text{VBW} = \text{RBW} = 100 * \text{Span}$$

$$\text{"Sweep Time"} = T_{\text{min}} \text{ for set Span, RBW, VBW}$$

When defining the bandwidth and filter settings, consider the impact of the individual settings on the other settings and the measurement result, as described in more detail in the following sections.

- [Separating Signals by Selecting an Appropriate Resolution Bandwidth](#)..... 435
- [Smoothing the Trace Using the Video Bandwidth](#)..... 436
- [Coupling VBW and RBW](#)..... 436
- [Coupling Span and RBW](#)..... 437
- [How Data is Measured: the Sweep Type](#)..... 437
- [Which Data May Pass: Filter Types](#)..... 438
- [How Long the Data is Measured: Sweep Time](#) ..... 439
- [How Much Data is Measured: Sweep Points and Sweep Count](#)..... 439
- [How Often Data is Measured: Sweep Mode](#)..... 440

### 8.6.1.1 Separating Signals by Selecting an Appropriate Resolution Bandwidth

The resolution bandwidth defines the 3 dB bandwidth of the resolution filter to be used. An RF sinusoidal signal is displayed according to the passband characteristic of the resolution filter (RBW), i.e. the signal display reflects the shape of the filter.

A basic feature of a signal analyzer is being able to separate the spectral components of a mixture of signals. The resolution at which the individual components can be separated is determined by the resolution bandwidth. Selecting a resolution bandwidth that is too large may make it impossible to distinguish between spectral components, i.e. they are displayed as a single component. Smaller resolution bandwidths, however, increase the required "Sweep Time" .

Two signals with the same amplitude can be resolved if the resolution bandwidth is smaller than or equal to the frequency spacing of the signal. If the resolution bandwidth is equal to the frequency spacing, the spectrum display screen shows a level drop of 3 dB precisely in the center of the two signals. Decreasing the resolution bandwidth makes the level drop larger, which thus makes the individual signals clearer.

The highest sensitivity is obtained at the smallest bandwidth (1 Hz). If the bandwidth is increased, the reduction in sensitivity is proportional to the change in bandwidth. Increasing the bandwidth by a factor of 3 increases the displayed noise by approx. 5 dB (4.77 dB precisely). If the bandwidth is increased by a factor of 10, the displayed noise increases by a factor of 10, i.e. 10 dB.

If there are large level differences between signals, the resolution is determined by selectivity as well as by the resolution bandwidth that has been selected. The measure

of selectivity used for signal analyzers is the ratio of the 60 dB bandwidth to the 3 dB bandwidth (= shape factor).

For the R&S FPL1000, the shape factor for bandwidths is  $< 5$ , i.e. the 60 dB bandwidth of the 30 kHz filter is  $< 150$  kHz.

The higher spectral resolution with smaller bandwidths is won by longer "Sweep Time" s for the same span. The "Sweep Time" has to allow the resolution filters to settle during a sweep at all signal levels and frequencies to be displayed.

If the RBW is too large, signal parts that are very far away (e.g. from a different signal) are considered in the measurement and distort the results. The noise increases.

If the RBW is too small, parts of the signal are lost. As the displayed signal always reflects the shape of the filter, select a bandwidth large enough so the displayed signal reflects the entire shape of the filter.

### 8.6.1.2 Smoothing the Trace Using the Video Bandwidth

The video filters are responsible for smoothing the displayed trace. Using video bandwidths that are small compared to the resolution bandwidth, only the signal average is displayed and noise peaks and pulsed signals are repressed. If pulsed signals are to be measured, it is advisable to use a video bandwidth that is large compared to the resolution bandwidth ( $VBW = 10 \times RBW$ ) for the amplitudes of pulses to be measured correctly.

The level of a sine wave signal is not influenced by the video bandwidth. A sine wave signal can therefore be freed from noise by using a video bandwidth that is small compared with the resolution bandwidth, and thus be measured more accurately.



#### RMS/Average detector and VBW

If an RMS or average detector is used, the video bandwidth in the hardware is bypassed. Thus, duplicate trace averaging with small VBWs and RMS or average detector no longer occurs. However, the VBW is still considered when calculating the "Sweep Time" . This leads to a longer "Sweep Time" for small VBW values. Thus, you can reduce the VBW value to achieve more stable trace curves even when using an RMS or average detector. Normally, if the RMS or average detector is used the "Sweep Time" should be increased to get more stable traces.

---

### 8.6.1.3 Coupling VBW and RBW

The video bandwidth can be coupled to the resolution bandwidth automatically. In this case, if the resolution bandwidth is changed, the video bandwidth is automatically adjusted.

Coupling is recommended if a minimum "Sweep Time" is required for a selected resolution bandwidth. Narrow video bandwidths require longer "Sweep Time" s due to the longer settling time. Wide bandwidths reduce the signal/noise ratio.

**Table 8-20: Overview of RBW/VBW ratios and recommendations for use**

| Ratio RBW/VBW                | Recommendation for use                                                                                                                                                                                   |
|------------------------------|----------------------------------------------------------------------------------------------------------------------------------------------------------------------------------------------------------|
| 1/1                          | Recommended for sinusoidal signals<br>This is the default setting for automatic coupling.                                                                                                                |
| 0.1                          | Recommended when the amplitudes of pulsed signals are to be measured correctly. The IF filter is exclusively responsible for the pulse shape. No additional evaluation is performed by the video filter. |
| 10                           | Recommended to suppress noise and pulsed signals in the video domain.                                                                                                                                    |
| Manually set (0.001 to 1000) | Recommended for other measurement requirements                                                                                                                                                           |

#### 8.6.1.4 Coupling Span and RBW

The resolution bandwidth can be coupled to the span setting, either by a manually defined factor or automatically. If the span is changed, the resolution bandwidth is automatically adjusted. The automatic coupling adapts the resolution bandwidth to the currently set frequency span/100.

With a span/RBW ratio of 100 and a screen resolution of 1000 pixels, each frequency in the spectrum is displayed by 10 pixels. A span/RBW ratio of 1000 provides the highest resolution.

A higher span/RBW ratio (i.e. low RBW values and large frequency spans), however, results in large amounts of data.

#### 8.6.1.5 How Data is Measured: the Sweep Type

In a standard analog **frequency sweep**, the local oscillator of the analyzer sweeps the applied signal quasi analog from the start to the stop frequency to determine the frequency spectrum.

Alternatively, the analyzer can sample signal levels over time at a defined frequency and transform the data to a spectrum by Fast Fourier Transformation (**FFT**). Although this measurement method requires additional calculations, it can provide results much faster than the frequency sweep, in particular for small RBWs.

Which sweep mode is appropriate for the current measurement depends on the span, RBW, VBW and "Sweep Time" settings. The R&S FPL1000 automatically selects the appropriate sweep type. For RBWs lower than 100 kHz and for gated measurements, an FFT is performed, otherwise a sweep is performed.

#### Optimization

In FFT mode, FFT analysis is performed to determine a spectrum of frequencies. Several analysis steps are required to cover the entire span. The partial span which is covered by one FFT analysis depends on the RBW. The partial span cannot be defined directly, but it can be optimized according to measurement requirements.

Narrow partial spans provide a higher dynamic range, and also allow you to perform measurements near a carrier with a reduced reference level. With a wide partial span, the carrier and the useful signal are likely to be measured at the same time, in which

case the powers of both signals are summarized, so the reference level must be high enough to consider this factor. With a narrow partial span, this is less likely to happen, so the reference level can be reduced.

**For an optimal dynamic range**, the narrowest possible partial span (depending on the RBW) is used. Furthermore, the autorange function for the internal IF gain calculation is activated to obtain the best control range of the A/D converter.

On the other hand, the narrower the partial span, the more steps are required to cover the entire span, thus increasing analysis and calculation time. To **optimize the sweep rate**, the widest possible partial span (depending on the RBW) is used.



For an optimal sweep rate, it is recommended that you set the "Sweep Time" to "Auto" , as well.

For general purpose measurements, an "Auto" mode is available, which provides a **compromise between a large dynamic range and a fast sweep**. In this case, a medium-sized partial span is used.

#### Optimization for zero span sweeps

For normal sweeps in the time domain (zero span), the optimization mode determines the selection of the A/D converter prefilter, which depends on the RBW.

In **"Dynamic" mode**, the narrowest possible prefilter is used.

In **"Speed" mode**, the widest possible prefilter is used.

In **"Auto" mode**, a medium-sized prefilter is used.

#### 8.6.1.6 Which Data May Pass: Filter Types

While the filter is irrelevant when measuring individual narrowband signals (as long as the signal remains within the RBW), the measurement result for broadband signals is very dependant on the selected filter type and its shape. If the filter is too narrow, the signal is distorted by the filter. If the filter is too wide, multiple signals can no longer be distinguished. Generally, the smaller the filter width and the steeper its edges, the longer the settling time and thus the longer the "Sweep Time" must be.

All resolution bandwidths are realized with digital filters. Normal (3dB) Gaussian filters are set by default. Some communication standards require different filters.

For a list of available filter types, see [Chapter 8.6.3, "Reference: List of Available RRC and Channel Filters"](#), on page 448.

#### Normal (3 dB) Gaussian filters

Gaussian filters provide a good compromise between steep edges and a short settling time. This filter is suitable for most measurement tasks and is used by default.

The available Gaussian (3 dB) filters are listed in the R&S FPL1000 data sheet.

### Channel filters

Channel filters are fairly steep but require a long settling time; they are useful for pulse measurements in the time domain.

#### 8.6.1.7 How Long the Data is Measured: Sweep Time

Each filter has a settling time that must be awaited in order to obtain correct results. Since the resolution bandwidth and video bandwidth define the filter, the smaller of the two determines the minimum "Sweep Time" required for the measurement. Allowed values depend on the ratio of span to RBW and RBW to VBW.

If the selected "Sweep Time" is too short for the selected bandwidth and span, level measurement errors will occur. In this case, the R&S FPL1000 displays the error message "Sweep time too low" and marks the indicated "Sweep Time" with a red bullet. Furthermore, a status bit indicates an error.

(For more information see ["STATus:QUEStionable:TIME Register"](#) on page 200.)

The "Sweep Time" can be coupled to the span (not zero span), video bandwidth (VBW) and resolution bandwidth (RBW) automatically. If the span, resolution bandwidth or video bandwidth is changed, the "Sweep Time" is automatically adjusted.



Note that the "Sweep Time" only indicates how long data is captured; the time required to process the captured data may be considerably longer, in particular for FFT mode. For FFT mode, an estimated duration is indicated behind the "Sweep Time" in the channel bar (for RF measurements only).

---

#### 8.6.1.8 How Much Data is Measured: Sweep Points and Sweep Count

By default, 1001 data points are determined in a single sweep. During the next sweep, 1001 new data points are collected, and so on. The number of **sweep points** defines how much of the entire span is covered by a single data point. By increasing the number of sweep points you can increase the reliability of the individual data points and thus the accuracy of the analyzed results. However, these data points are all stored on the instrument, occupying a large amount of memory, and each sweep point increases the overall measurement time.

The number of sweeps to be performed in single sweep mode is defined by the "Sweep Count". Values from 0 to 200000 are allowed. If the values 0 or 1 are set, one sweep is performed. The sweep count is applied to all the traces in a diagram.

If the trace configurations "Average" , "Max Hold" or "Min Hold" are set, the "Sweep/Average Count" also determines the number of averaging or maximum search procedures (see ["Analyzing Several Traces - Trace Mode"](#) on page 506).

For details on how the number of sweep points and the sweep count affect the trace results on the screen, see ["Mapping Samples to sweep Points with the Trace Detector"](#) on page 503.

### 8.6.1.9 How Often Data is Measured: Sweep Mode

How often the spectrum is swept depends on the sweep mode. Either a certain number of sweeps can be defined ("Sweep Count") which are performed in "Single Sweep" mode, or the sweep is repeated continuously ("Continuous Sweep" mode).

By default, the data is collected for the specified number of sweeps and the corresponding trace is displayed. When the next sweep is started, the previous trace is deleted.

However, the data from a single sweep run can also be retained and displayed together with the new data ("Continue Single Sweep" mode). This is particularly of interest when using the trace configurations "Average" or "Max Hold" to take previously recorded measurements into account for averaging/maximum search (see ["Analyzing Several Traces - Trace Mode"](#) on page 506).

## 8.6.2 Bandwidth, Filter and Sweep Settings

**Access:** "Overview" > "Bandwidth"

The remote commands required to define these settings are described in [Chapter 9.8.2, "Configuring Bandwidth and Sweep Settings"](#), on page 721.

How to perform a basic sweep measurement is described in [Chapter 8.2.1.2, "How to Perform a Basic Sweep Measurement"](#), on page 241.

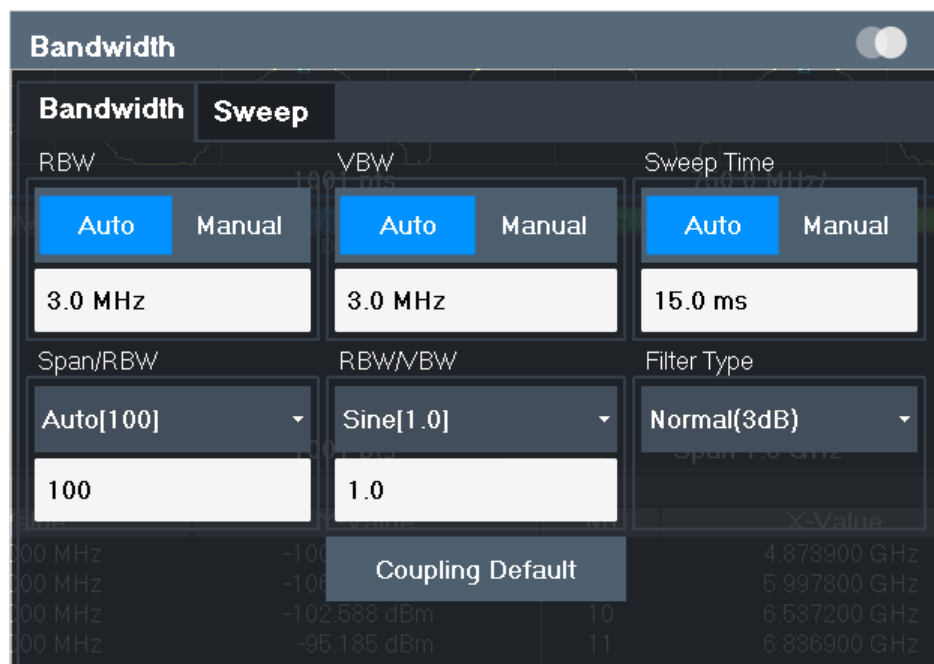

Figure 8-41: Bandwidth dialog box for RF measurements



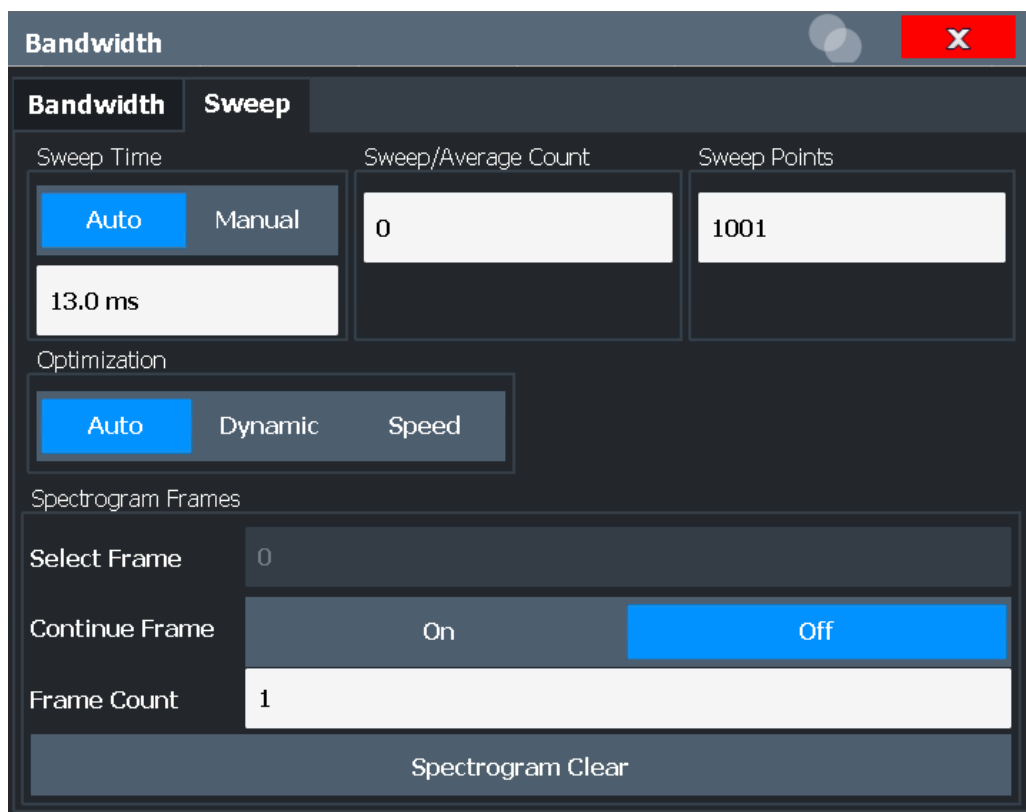

Figure 8-42: Sweep dialog box for spectrogram display

|                                   |     |
|-----------------------------------|-----|
| RBW .....                         | 441 |
| VBW .....                         | 442 |
| Sweep Time .....                  | 442 |
| Span/RBW .....                    | 443 |
| RBW/VBW .....                     | 443 |
| Filter Type .....                 | 443 |
| Default Coupling .....            | 444 |
| Sweep/Average Count .....         | 444 |
| Sweep Points.....                 | 444 |
| Optimization .....                | 445 |
| Sweep Type.....                   | 445 |
| Single Sweep / Run Single .....   | 445 |
| Continuous Sweep / Run Cont ..... | 446 |
| Continue Single Sweep .....       | 446 |
| Spectrogram Frames .....          | 447 |
| L Select Frame.....               | 447 |
| L Continue Frame .....            | 447 |
| L Frame Count .....               | 447 |
| L Clear Spectrogram .....         | 447 |

**RBW**

Defines the resolution bandwidth. The available resolution bandwidths are specified in the data sheet. Numeric input is always rounded to the nearest possible bandwidth.

If "Auto" is selected, the resolution bandwidth is coupled to the selected span (for span > 0). If the span is changed, the resolution bandwidth is automatically adjusted.

If the resolution bandwidth is defined manually, a green bullet is displayed next to the "RBW" display in the channel bar.

For more information see [Chapter 8.6.1.1, "Separating Signals by Selecting an Appropriate Resolution Bandwidth"](#), on page 435.

**Note:** Restrictions.

- For EMI measurements using the quasipeak detector, the 1 MHz RBW filter is not available (see ["Resolution Bandwidth and Filter Types"](#) on page 388).

Remote command:

[\[SENSe:\]BANDwidth\[:RESolution\]](#) on page 722

[\[SENSe:\]BANDwidth\[:RESolution\]:AUTO](#) on page 722

### VBW

Defines the video bandwidth automatically or manually.

For more information see [Chapter 8.6.1.2, "Smoothing the Trace Using the Video Bandwidth"](#), on page 436.

|          |                                                                                                                                                                                                                                                                                                          |
|----------|----------------------------------------------------------------------------------------------------------------------------------------------------------------------------------------------------------------------------------------------------------------------------------------------------------|
| "Auto"   | The video bandwidth is coupled to the resolution bandwidth. If the resolution bandwidth is changed, the video bandwidth is automatically adjusted.                                                                                                                                                       |
| "Manual" | For manual mode, define the bandwidth value. The available video bandwidths are specified in the data sheet. Numeric input is always rounded to the nearest possible bandwidth.<br>If the video bandwidth is defined manually, a green bullet is displayed next to the "VBW" display in the channel bar. |

Remote command:

[\[SENSe:\]BANDwidth:VIDeo:AUTO](#) on page 724

[\[SENSe:\]BANDwidth:VIDeo](#) on page 724

### Sweep Time

Defines the duration of a single sweep, during which the defined number of sweep points are measured. The "Sweep Time" can be defined automatically or manually.

The allowed "Sweep Time" s depend on the device model; refer to the data sheet.

For more information see [Chapter 8.6.1.7, "How Long the Data is Measured: Sweep Time"](#), on page 439.

**Note:** The "Sweep Time" only indicates how long data is captured; the time required to process the captured data may be considerably longer, in particular for FFT mode. For FFT mode, an estimated duration is indicated behind the "Sweep Time" in the channel bar (for RF measurements only).

|        |                                                                                                                                                                                                                             |
|--------|-----------------------------------------------------------------------------------------------------------------------------------------------------------------------------------------------------------------------------|
| "Auto" | The "Sweep Time" is coupled to the span (not zero span), video bandwidth (VBW) and resolution bandwidth (RBW). If the span, resolution bandwidth or video bandwidth is changed, the "Sweep Time" is automatically adjusted. |
|--------|-----------------------------------------------------------------------------------------------------------------------------------------------------------------------------------------------------------------------------|

"Manual" For manual mode, define the "Sweep Time" . Allowed values depend on the ratio of span to RBW and RBW to VBW. For details refer to the data sheet. Numeric input is always rounded to the nearest possible "Sweep Time" .

Remote command:

[SENSE:]SWEep:TIME:AUTO on page 728

[SENSE:]SWEep:TIME on page 728

[SENSE:]SWEep:DURation? on page 726

### Span/RBW

Sets the coupling ratio if RBW is set to auto mode.

For more information see [Chapter 8.6.1.4, "Coupling Span and RBW"](#), on page 437.

"Auto[100]" "Resolution Bandwidth" = "Span/100"  
This coupling ratio is the default setting of the R&S FPL1000.

"Manual" The coupling ratio is defined manually.  
The span/resolution bandwidth ratio can be set in the range from 1 to 10000.

Remote command:

[SENSE:]BANDwidth[:RESolution]:RATio on page 723

### RBW/VBW

Sets the coupling ratio between the resolution bandwidth and the video bandwidth.

This setting is only effective if VBW is set to auto mode.

For more information see [Chapter 8.6.1.3, "Coupling VBW and RBW"](#), on page 436.

"Sine[1/1]" "Video Bandwidth" = "Resolution Bandwidth"  
This is the default setting for the coupling ratio RBW/VBW and is recommended if sinusoidal signals are to be measured.

"Pulse[0.1]" "Video Bandwidth" = 10 x "Resolution Bandwidth"  
or  
"Video Bandwidth" = "10 MHz" (= max. VBW)  
Recommended for pulse signals

"Noise[10]" "Video Bandwidth" = "Resolution Bandwidth/10"  
Recommended for noise measurements

"Manual" The coupling ratio is defined manually.  
The RBW/VBW ratio can be set in the range of 0.001 to 1000.

Remote command:

[SENSE:]BANDwidth:VIDeo:AUTO on page 724

[SENSE:]BANDwidth:VIDeo:RATio on page 724

### Filter Type

Defines the filter type.

The following filter types are available:

- Normal (3dB)
- Channel
- CISPR (6 dB) - requires EMI (R&S FPL1-K54) option

- MIL Std (6 dB) - requires EMI (R&S FPL1-K54) option

For more information see [Chapter 8.6.1.6, "Which Data May Pass: Filter Types"](#), on page 438.

**Note:** The EMI-specific filter types are available if the EMI (R&S FPL1-K54) measurement option is installed, even if EMI measurement is not active. For details see "[Resolution Bandwidth and Filter Types](#)" on page 388.

The RBW filter configured in the bandwidth settings is identical to the filter configured in the EMI configuration.

Remote command:

`[SENSe:]BANDwidth[:RESolution]:TYPE` on page 723

### Default Coupling

Sets all coupled functions to the default state ( "Auto" ). In addition, the ratio "RBW/VBW" is set to "Sine[1/1]" and the ratio "Span/RBW" to 100.

For more information see [Chapter 8.6.1.3, "Coupling VBW and RBW"](#), on page 436.

Remote command:

`[SENSe:]BANDwidth[:RESolution]:AUTO` on page 722

`[SENSe:]BANDwidth:VIDeo:AUTO` on page 724

`[SENSe:]SWEep:TIME:AUTO` on page 728

### Sweep/Average Count

Defines the number of sweeps to be performed in the single sweep mode. Values from 0 to 200000 are allowed. If the values 0 or 1 are set, one sweep is performed.

The sweep count is applied to all the traces in all diagrams.

If the trace modes "Average" , "Max Hold" or "Min Hold" are set, this value also determines the number of averaging or maximum search procedures.

In continuous sweep mode, if "Sweep Count" = 0 (default), averaging is performed over 10 sweeps. For "Sweep Count" =1, no averaging, maxhold or minhold operations are performed.

For more information, see [Chapter 8.6.1.8, "How Much Data is Measured: Sweep Points and Sweep Count"](#), on page 439.

For spectrogram displays, the sweep count determines how many sweeps are combined in one frame in the spectrogram; that is: how many sweeps the R&S FPL1000 performs to plot one trace in the spectrogram result display. For more details, see "[Time Frames](#)" on page 517.

Remote command:

`[SENSe:]SWEep:COUNT` on page 725

`[SENSe:]AVERAge<n>:COUNT` on page 763

### Sweep Points

Defines the number of measured values to be collected during one sweep.

For details see [Chapter 8.6.1.8, "How Much Data is Measured: Sweep Points and Sweep Count"](#), on page 439.

All values from 101 to 100001 can be set. The default value is 1001 sweep points.

Remote command:

[SENSe:] SWEep [: WINDow<n>] : POINTs on page 727

### Optimization

In FFT mode, several FFT analysis steps are required to cover the entire measurement span. The span which is covered by one FFT analysis step is called *partial span*. The partial span cannot be defined directly, but it can be optimized according to measurement requirements.

**Table 8-21: Optimization parameters in FFT mode**

| Optimization mode | Description                                                                                                                                                                                                                                                                                                                                                                       |
|-------------------|-----------------------------------------------------------------------------------------------------------------------------------------------------------------------------------------------------------------------------------------------------------------------------------------------------------------------------------------------------------------------------------|
| Dynamic           | Optimizes the dynamic range by using the narrowest possible partial span (depending on the RBW).<br>The autorange function for the internal IF gain calculation is activated to obtain the best control range for the A/D converter.                                                                                                                                              |
| Speed             | Optimizes the sweep rate by using the widest possible partial span (depending on the RBW).<br>The autorange function for the internal IF gain calculation is deactivated. (Note: set the reference level accordingly to optimize the control range for the A/D converter).<br>It is recommended that you set the <a href="#">Sweep Time</a> to "Auto" to optimize the sweep rate. |
| Auto              | Uses a medium-sized partial span to obtain a compromise between a large dynamic range and a fast sweep rate.<br>The autorange function for the internal IF gain calculation is deactivated. (Note: set the reference level accordingly to optimize the control range for the A/D converter).                                                                                      |

### Zero span mode

For zero span measurements, the optimization mode defines the selection of the A/D converter prefilter.

**Table 8-22: Optimization parameters in zero span mode**

| Optimization mode | Description                                                   |
|-------------------|---------------------------------------------------------------|
| Dynamic           | The narrowest filter possible (depending on the RBW) is used. |
| Speed             | The widest filter possible (depending on the RBW) is used.    |
| Auto              | A medium-sized prefilter is used.                             |

Remote command:

[SENSe:] SWEep: OPTimize on page 726

### Sweep Type

The R&S FPL1000 automatically sets the optimal sweep type for the current measurement (sweep or FFT). The sweep type cannot be defined manually.

### Single Sweep / Run Single

After triggering, starts the number of sweeps set in "Sweep Count". The measurement stops after the defined number of sweeps has been performed.

While the measurement is running, the "Single Sweep" softkey and the [RUN SINGLE] key are highlighted. The running measurement can be aborted by selecting the highlighted softkey or key again.

**Note:** Sequencer. If the Sequencer is active, the "Single Sweep" softkey only controls the sweep mode for the currently selected channel setup. However, the sweep mode only takes effect the next time the Sequencer activates that channel setup, and only for a channel-defined sequence. In this case, the Sequencer sweeps a channel setup in single sweep mode only once.

Furthermore, the [RUN SINGLE] key controls the Sequencer, not individual sweeps. [RUN SINGLE] starts the Sequencer in single mode.

If the Sequencer is off, only the evaluation for the currently displayed channel setup is updated.

For details on the Sequencer, see [Chapter 6.4.1, "The Sequencer Concept"](#), on page 89.

Remote command:

`INITiate<n>[:IMMediate]` on page 590

`CALCulate<n>:SPECTrogram:CONTInuous` on page 767

### Continuous Sweep / Run Cont

After triggering, starts the sweep and repeats it continuously until stopped. This is the default setting.

After triggering, starts the measurement and repeats it continuously until stopped.

While the measurement is running, the "Continuous Sweep" softkey and the [RUN CONT] key are highlighted. The running measurement can be aborted by selecting the highlighted softkey or key again. The results are not deleted until a new measurement is started.

**Note:** Sequencer. If the Sequencer is active, the "Continuous Sweep" softkey only controls the sweep mode for the currently selected channel setup. However, the sweep mode only takes effect the next time the Sequencer activates that channel setup, and only for a channel-defined sequence. In this case, a channel setup in continuous sweep mode is swept repeatedly.

Furthermore, the [RUN CONT] key controls the Sequencer, not individual sweeps. [RUN CONT] starts the Sequencer in continuous mode.

For details on the Sequencer, see [Chapter 6.4.1, "The Sequencer Concept"](#), on page 89.

Remote command:

`INITiate<n>:CONTInuous` on page 589

### Continue Single Sweep

After triggering, repeats the number of sweeps set in "Sweep Count", without deleting the trace of the last measurement.

While the measurement is running, the "Continue Single Sweep" softkey and the [RUN SINGLE] key are highlighted. The running measurement can be aborted by selecting the highlighted softkey or key again.

Remote command:

`INITiate<n>:CONMeas` on page 589

**Spectrogram Frames**

These settings are only available if spectrogram display is active.

For more information see [Chapter 8.10.2.3, "How to Display and Configure a Spectrogram"](#), on page 529.

**Select Frame ← Spectrogram Frames**

Selects a specific frame, loads the corresponding trace from the memory, and displays it in the Spectrum window.

Note that activating a marker or changing the position of the active marker automatically selects the frame that belongs to that marker.

This function is only available in single sweep mode or if the sweep is stopped, and only if a spectrogram is selected.

The most recent frame is number 0, all previous frames have a negative number.

For more details see ["Time Frames"](#) on page 517.

Remote command:

`CALCulate<n>:SPECTrogram:FRAMe:SElect` on page 768

**Continue Frame ← Spectrogram Frames**

Determines whether the results of the previous sweeps are included in the analysis of the next sweeps for trace modes "Max Hold", "Min Hold", and "Average".

This function is available in single sweep mode only.

- **On**

When the average or peak values are determined for the new sweep, the results of the previous sweeps in the spectrogram are also taken into account.

- **Off**

The average or peak values are determined from the results of the newly swept frames only.

Remote command:

`CALCulate<n>:SPECTrogram:CONTInuous` on page 767

**Frame Count ← Spectrogram Frames**

Determines how many frames are plotted during a single sweep (as opposed to a continuous sweep). The maximum number of possible frames depends on the history depth (see ["History Depth"](#) on page 526).

Remote command:

`CALCulate<n>:SPECTrogram:FRAMe:COUNT` on page 767

**Clear Spectrogram ← Spectrogram Frames**

Resets the spectrogram result display and clears the history buffer.

This function is only available if a spectrogram is selected.

Remote command:

`CALCulate<n>:SPECTrogram:CLEAr[:IMMediate]` on page 766

### 8.6.3 Reference: List of Available RRC and Channel Filters

For power measurement a number of especially steep-edged channel filters are available (see the following table). The indicated filter bandwidth is the 3 dB bandwidth.



The available Gaussian 3 dB sweep filters are listed in the R&S FPL1000 data sheet.

**Table 8-23: Filter types**

| Filter Bandwidth | Filter Type | Application                    |
|------------------|-------------|--------------------------------|
| 100 Hz           | CFILter     |                                |
| 200 Hz           | CFILter     |                                |
| 300 Hz           | CFILter     |                                |
| 500 Hz           | CFILter     |                                |
| 1 kHz            | CFILter     |                                |
| 1.5 kHz          | CFILter     |                                |
| 2 kHz            | CFILter     |                                |
| 2.4 kHz          | CFILter     | SSB                            |
| 2.7 kHz          | CFILter     |                                |
| 3 kHz            | CFILter     |                                |
| 3.4 kHz          | CFILter     |                                |
| 4 kHz            | CFILter     | DAB, Satellite                 |
| 4.5 kHz          | CFILter     |                                |
| 5 kHz            | CFILter     |                                |
| 6 kHz            | CFILter     |                                |
| 8.5 kHz          | CFILter     | ETS300 113 (12.5 kHz channels) |
| 9 kHz            | CFILter     | AM Radio                       |
| 10 kHz           | CFILter     |                                |
| 12.5 kHz         | CFILter     | CDMAone                        |
| 14 kHz           | CFILter     | ETS300 113 (20 kHz channels)   |
| 15 kHz           | CFILter     |                                |
| 16 kHz           | CFILter     | ETS300 113 (25 kHz channels)   |
| 20 kHz           | CFILter     |                                |
| 21 kHz           | CFILter     | PDC                            |



| Filter Bandwidth | Filter Type | Application                        |
|------------------|-------------|------------------------------------|
| 25 kHz           | CFILter     | APCO 25-P2                         |
| 30 kHz           | CFILter     | CDPD, CDMAone                      |
| 50 kHz           | CFILter     |                                    |
| 100 kHz          | CFILter     |                                    |
| 150 kHz          | CFILter     | FM Radio                           |
| 192 kHz          | CFILter     | PHS                                |
| 200 kHz          | CFILter     | GSM                                |
| 300 kHz          | CFILter     |                                    |
| 500 kHz          | CFILter     | J.83 (8-VSB DVB, USA); RF ID 14333 |
| 1 MHz            | CFILter     | CDMAone                            |
| 1.228 MHz        | CFILter     | CDMAone                            |
| 1.5 MHz          | CFILter     | DAB                                |
| 2 MHz            | CFILter     |                                    |
| 3 MHz            | CFILter     |                                    |
| 3.75 MHz         | CFILter     |                                    |
| 5 MHz            | CFILter     |                                    |
|                  | CFILter     |                                    |
|                  | CFILter     |                                    |
|                  | CFILter     |                                    |

## 8.7 Trigger and Gate Configuration

Triggering means to capture the interesting part of the signal. Choosing the right trigger type and configuring all trigger settings correctly allows you to detect various incidents in your signals.

Gating allows you to restrict measurement analysis to the important part or parts of the signal, for example bursts.

- [Triggering](#)..... 450
- [Gating](#)..... 458

## 8.7.1 Triggering

### 8.7.1.1 Triggered Measurements

In a basic measurement with default settings, the sweep is started immediately. However, sometimes you want the measurement to start only when a specific condition is fulfilled, for example a signal level is exceeded, or in certain time intervals. For these cases you can define a trigger for the measurement. In FFT sweep mode, the trigger defines when the data acquisition starts for the FFT conversion.

An "Offset" can be defined to delay the measurement after the trigger event, or to include data before the actual trigger event in time domain measurements (pre-trigger offset).

For complex tasks, advanced trigger settings are available:

- Hysteresis to avoid unwanted trigger events caused by noise
- Holdoff to define exactly which trigger event will cause the trigger in a jittering signal
- [Trigger Source](#)..... 450
- [Trigger Offset](#)..... 450
- [Trigger Hysteresis](#)..... 451
- [Trigger Drop-Out Time](#)..... 451
- [Trigger Holdoff](#)..... 452

#### Trigger Source

The trigger source defines which source must fulfill the condition that triggers the measurement. Basically, this can be:

- Time: the measurement is repeated in a regular interval
- Power: an input signal is checked for a defined power level  
The trigger signal can be any of the following:
  - The input signal at one of various stages in the signal analysis process - before or after the input mixer, after the video filter etc.
  - A signal from an external device via one of the TRIGGER INPUT / OUTPUT connectors on the instrument

For details on the available trigger sources see "[Trigger Source](#)" on page 454.

#### Trigger Offset

An offset can be defined to delay the measurement after the trigger event, or to include data before the actual trigger event in time domain measurements (pre-trigger offset). Pre-trigger offsets are possible because the R&S FPL1000 captures data continuously in the time domain, even before the trigger occurs.

See "[Trigger Offset](#)" on page 456.

### Trigger Hysteresis

Setting a hysteresis for the trigger helps avoid unwanted trigger events caused by noise, for example. The hysteresis is a threshold to the trigger level that the signal must fall below on a rising slope or rise above on a falling slope before another trigger event occurs.

#### Example:

In the following example, the second possible trigger event on the rising edge is ignored as the signal does not drop below the hysteresis (threshold) before it reaches the trigger level again. On the falling edge, however, two trigger events occur as the signal exceeds the hysteresis before it falls to the trigger level the second time.

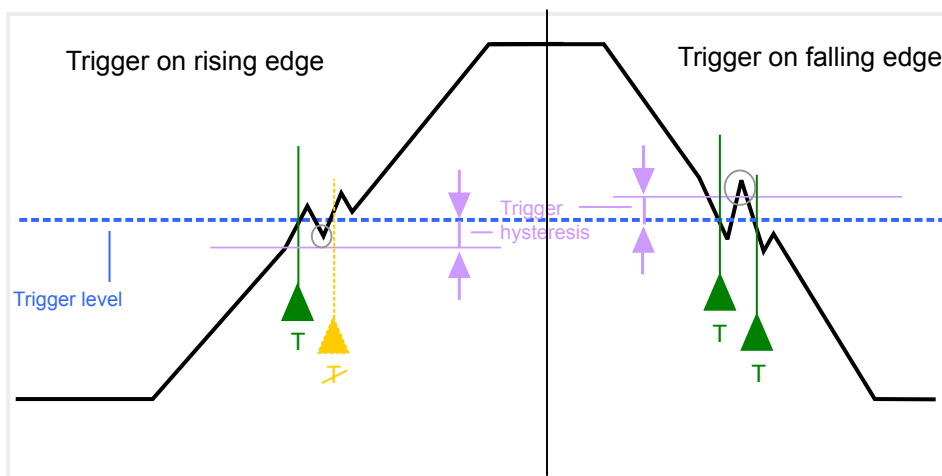

Figure 8-43: Effects of the trigger hysteresis

See " Hysteresis " on page 456

### Trigger Drop-Out Time

If a modulated signal is instable and produces occasional "drop-outs" during a burst, you can define a minimum duration that the input signal must stay below the trigger level before triggering again. This is called the "drop-out" time. Defining a dropout time helps you stabilize triggering when the analyzer is triggering on undesired events.

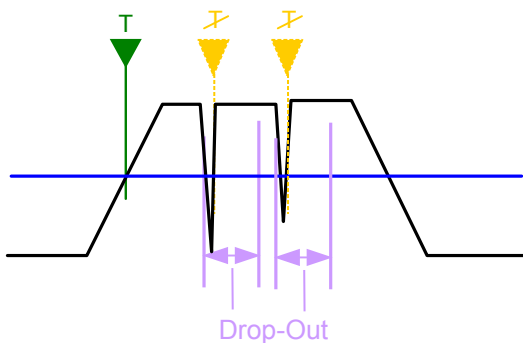

Figure 8-44: Effect of the trigger drop-out time

See " Drop-Out Time " on page 456.



### Drop-out times for falling edge triggers

If a trigger is set to a falling edge ( "Slope" = "Falling" , see " Slope " on page 457) the measurement is to start when the power level falls below a certain level. This is useful, for example, to trigger at the end of a burst, similar to triggering on the rising edge for the beginning of a burst.

If a drop-out time is defined, the power level must remain below the trigger level at least for the duration of the drop-out time (as defined above). However, if a drop-out time is defined that is longer than the pulse width, this condition cannot be met before the final pulse, so a trigger event will not occur until the pulsed signal is over!

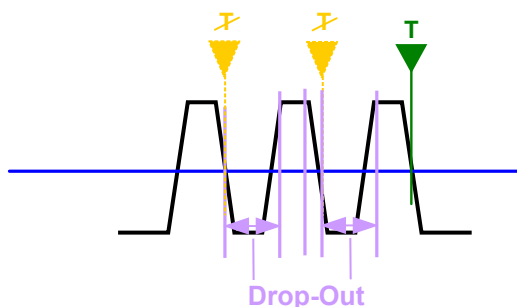

Figure 8-45: Trigger drop-out time for falling edge trigger

For gated measurements, a combination of a falling edge trigger and a drop-out time is generally not allowed.

### Trigger Holdoff

The trigger holdoff defines a waiting period before the next trigger after the current one will be recognized.

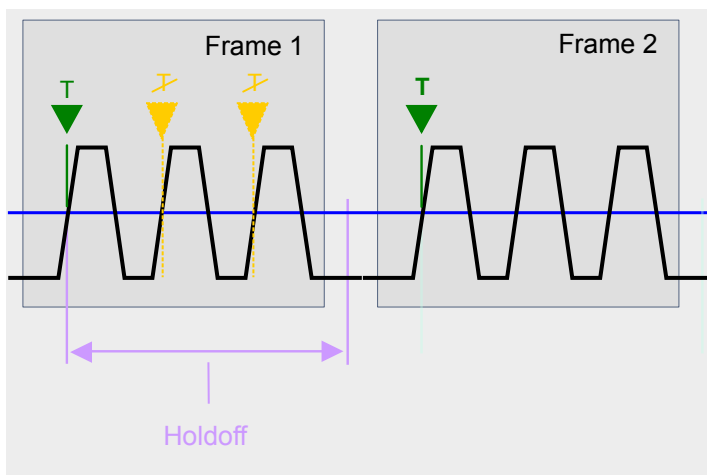
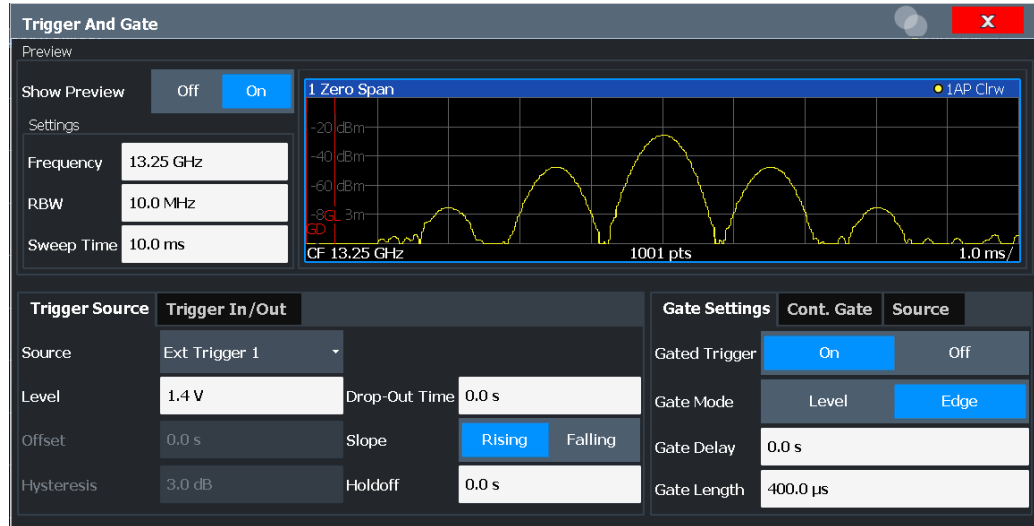

Figure 8-46: Effect of the trigger holdoff

See " Trigger Holdoff " on page 457.

8.7.1.2 Trigger Settings

Access: "Overview" > "Trigger/Gate"



External triggers from one of the TRIGGER INPUT / OUTPUT connectors on the R&S FPL1000 are configured in a separate tab of the dialog box.

For step-by-step instructions on configuring triggered measurements, see [Chapter 8.7.1.4, "How to Configure a Triggered Measurement"](#), on page 457.

- Preview ..... 453
  - Frequency ..... 454
  - RBW ..... 454
  - Sweep Time..... 454
- Trigger Source ..... 454
  - Free Run ..... 454
  - External Trigger 1 ..... 455
  - Video ..... 455
  - IF Power ..... 455
  - Time ..... 455
- Trigger Level ..... 455
- Repetition Interval ..... 456
- Drop-Out Time ..... 456
- Trigger Offset ..... 456
- Hysteresis ..... 456
- Trigger Holdoff ..... 457
- Slope ..... 457

**Preview**

The preview mode allows you to try out trigger and gate settings before actually applying them to the current measurement.

The preview diagram displays a zero span measurement at the center frequency with the defined RBW and sweep time. This is useful to analyze bursts, for example, to determine the required gate settings.

The trigger and gate settings are applied to the measurement when the dialog box is closed.

**Note:** The zero span settings refer only to the preview diagram. The main diagram remains unchanged.

If preview mode is switched off, any changes to the settings in this dialog box are applied to the measurement diagram directly. In this case, the zero span settings for the preview diagram are not displayed.

For information on the zero span settings see:

- " [Center Frequency](#) " on page 422
- " [RBW](#) " on page 401
- " [Sweep Time](#) " on page 442

#### **Frequency ← Preview**

Defines the center frequency.

Remote command:

[\[SENSe:\]FREQuency:CENTer](#) on page 713

#### **RBW ← Preview**

Defines the bandwidth value. The available resolution bandwidths are specified in the data sheet. Numeric input is always rounded to the nearest possible bandwidth.

Remote command:

[\[SENSe:\]BANDwidth\[:RESolution\]](#) on page 722

#### **Sweep Time ← Preview**

Defines the sweep time. Allowed values depend on the ratio of span to RBW and RBW to VBW. For details refer to the data sheet. Numeric input is always rounded to the nearest possible sweep time.

Remote command:

[\[SENSe:\]SWEep:TIME](#) on page 728

#### **Trigger Source**

Selects the trigger source. If a trigger source other than "Free Run" is set, "TRG" is displayed in the channel bar and the trigger source is indicated.

For gated measurements, this setting also selects the gating source.

For more information see "[Trigger Source](#)" on page 450.

Remote command:

[TRIGger\[:SEQuence\]:SOURce](#) on page 738

[\[SENSe:\]SWEep:EGATe:SOURce](#) on page 741

#### **Free Run ← Trigger Source**

No trigger source is considered. Data acquisition is started manually or automatically and continues until stopped explicitly.

In the Spectrum application, this is the default setting.

Remote command:

[TRIG:SOUR IMM](#), see [TRIGger\[:SEQuence\]:SOURce](#) on page 738

**External Trigger 1 ← Trigger Source**

Data acquisition starts when the TTL signal fed into the trigger input connector of the R&S FPL1000 meets or exceeds the specified trigger level.

(See " [Trigger Level](#) " on page 455).

Remote command:

TRIG:SOUR EXT

See [TRIGger\[:SEquence\]:SOURce](#) on page 738

SWE:EGAT:SOUR EXT for gated triggering, see [\[SENSe:\]SWEep:EGATe:SOURce](#) on page 741

**Video ← Trigger Source**

Defines triggering by the video signal, i.e. the filtered and detected version of the input signal (the envelope of the IF signal), as displayed on the screen.

Define a trigger level from 0 % to 100 % of the diagram height. The absolute trigger level is indicated by a horizontal trigger line in the diagram, which you can also move graphically to change the trigger level.

A fixed hysteresis of 10 % of the specified trigger value (in V) is applied to the video trigger level automatically and cannot be changed.

Video mode is only available in the time domain, and not for I/Q-based data.

Remote command:

TRIG:SOUR VID, see [TRIGger\[:SEquence\]:SOURce](#) on page 738

**IF Power ← Trigger Source**

The R&S FPL1000 starts capturing data as soon as the trigger level is exceeded around the third intermediate frequency.

For frequency sweeps, the third IF represents the start frequency. The trigger bandwidth at the third IF depends on the RBW and sweep type.

For measurements on a fixed frequency (e.g. zero span or I/Q measurements), the third IF represents the center frequency.

This trigger source is only available for RF input.

For details on available trigger levels and trigger bandwidths, see the data sheet.

**Note:** Be aware that in auto sweep type mode, due to a possible change in sweep types, the trigger bandwidth can vary considerably for the same RBW setting.

Remote command:

TRIG:SOUR IFP, see [TRIGger\[:SEquence\]:SOURce](#) on page 738

SWE:EGAT:SOUR IFP for gated triggering, see [\[SENSe:\]SWEep:EGATe:SOURce](#) on page 741

**Time ← Trigger Source**

Triggers in a specified repetition interval.

Remote command:

TRIG:SOUR TIME, see [TRIGger\[:SEquence\]:SOURce](#) on page 738

**Trigger Level**

Defines the trigger level for the specified trigger source.

For gated measurements, this setting also defines the gate level.

For details on supported trigger levels, see the data sheet.

Remote command:

[TRIGger\[:SEquence\]:LEVel:IFPower](#) on page 737

[TRIGger\[:SEquence\]:LEVel:IQPower](#) on page 737

[TRIGger<tp>\[:SEquence\]:LEVel\[:EXternal<port>\]](#) on page 737

### Repetition Interval

Defines the repetition interval for a time trigger. The shortest interval is 2 ms.

The repetition interval should be set to the exact pulse period, burst length, frame length or other repetitive signal characteristic.

Remote command:

[TRIGger\[:SEquence\]:TIME:RINTerval](#) on page 739

### Drop-Out Time

Defines the time the input signal must stay below the trigger level before triggering again.

For more information on the drop-out time, see "[Trigger Drop-Out Time](#)" on page 451.

Remote command:

[TRIGger\[:SEquence\]:DTIME](#) on page 735

### Trigger Offset

Defines the time offset between the trigger event and the start of the sweep.

For more information, see "[Trigger Offset](#)" on page 450.

|             |                                                                                                                                                                                                                                              |
|-------------|----------------------------------------------------------------------------------------------------------------------------------------------------------------------------------------------------------------------------------------------|
| Offset > 0: | Start of the sweep is delayed                                                                                                                                                                                                                |
| Offset < 0: | Sweep starts earlier (pretrigger)<br>Only possible for zero span (e.g. I/Q Analyzer application) and gated trigger switched off<br>Maximum allowed range limited by the sweep time:<br>$\text{Pretrigger}_{\max} = \text{sweep time}_{\max}$ |

For the "Time" trigger source, this function is not available.

Remote command:

[TRIGger\[:SEquence\]:HOLDoff\[:TIME\]](#) on page 735

### Hysteresis

Defines the distance in dB to the trigger level that the trigger source must exceed before a trigger event occurs. Setting a hysteresis avoids unwanted trigger events caused by noise oscillation around the trigger level.

This setting is only available for "IF Power" trigger sources. The range of the value is between 3 dB and 50 dB with a step width of 1 dB.

For more information, see "[Trigger Hysteresis](#)" on page 451.

Remote command:

[TRIGger\[:SEquence\]:IFPower:HYSteresis](#) on page 736



**Trigger Holdoff**

Defines the minimum time (in seconds) that must pass between two trigger events. Trigger events that occur during the holdoff time are ignored.

For more information, see ["Trigger Holdoff"](#) on page 452.

Remote command:

`TRIGger [:SEquence] :IFPower:HOLDoFF` on page 736

**Slope**

For all trigger sources except time, you can define whether triggering occurs when the signal rises to the trigger level or falls down to it.

For gated measurements in "Edge" mode, the slope also defines whether the gate starts on a falling or rising edge.

Remote command:

`TRIGger [:SEquence] :SLOPe` on page 738

`[SENSe:]SWEep:EGATe:POLarity` on page 740

**8.7.1.3 How to Determine the Required Trigger/Gate Parameters**

1. In the "Trigger And Gate" dialog box, switch on "Show Preview" .  
A zero span measurement for the currently defined center frequency is displayed.
2. Set the "Frequency" , "RBW" and "Sweep Time" such that the relevant part of the signal is displayed, for example a complete burst.
3. Determine the parameters you want to use to define the trigger and gate conditions from the preview diagram, for example:
  - the length of a burst or slot
  - the upper or lower power level of a pulse
  - the maximum noise level
  - the power level or time at which a certain incident occurs
4. Try out different trigger and gate settings as described in [How to Configure a Triggered Measurement](#) and [How to Configure a Gated Measurement](#), then select "Update Main Diagram" to see the effect of the current settings on the main measurement in the background.
5. If the results are as expected, close the dialog box to keep the changes permanently. Otherwise, correct the settings as necessary.

**8.7.1.4 How to Configure a Triggered Measurement****To define a time trigger:**

1. In the "Trigger And Gate" dialog box, define the "Trigger Source" = "Time" .

2. Define the "Repetition Interval" : the time after which a new measurement is started.

#### To define an external trigger:

1. Connect an external device that will provide the trigger signal to one of the TRIGGER INPUT / OUTPUT connectors on the R&S FPL1000 (for details see the R&S FPL1000 "Getting Started" manual).
2. In the "Trigger And Gate" dialog box, define the "Trigger Source" = "External" .
3. Configure the external trigger as described for the other power triggers.

#### To define a power trigger:

1. In the "Trigger And Gate" dialog box, define the "Trigger Source" = "IF Power" .
2. Define the "Trigger Level" : the power level at which the measurement will start.
3. Define whether the signal must cross the trigger level on a falling or on a rising edge ( "Slope" ) to trigger the measurement.
4. To start the measurement with a time delay, define a "Trigger Offset" .
5. To reject triggers due to noise or jittering in the signal, define a "Hysteresis" that is larger than the expected noise or jittering. After the previous trigger, the signal must exceed this threshold before the next level crossing triggers a new measurement.
6. To skip multiple triggers in a burst, define a "Holdoff" time that must pass between two triggers. The holdoff time should be slightly larger than the burst.

## 8.7.2 Gating

- [Gated Measurements](#).....458
- [Gate Settings](#)..... 459
- [How to Configure a Gated Measurement](#).....460

### 8.7.2.1 Gated Measurements

Like a gate provides an opening in a fence, a gated measurement lets data from the input signal pass in defined areas only. The *gate* controls exactly when data is included in the measurement results and when not. The gate is opened by the trigger source, which is also the gate source.

Gates can be used in two different modes:

- **Level:** The gate opens and the measurement starts when a defined level in the gate source is exceeded and stops when the gate source drops below the "Gate Level" .  
Using a pulsed gate signal in level mode, the following behavior can be achieved: When the gate source signal is active, the input signal data is collected; when the gate signal is inactive, the input signal is ignored.

- **Edge:** The gate opens and the measurement starts when a defined level in the gate source is exceeded and stops when the defined "Gate Length" is reached.

Additionally, a delay time can be defined so that the first few measurement points after the gate opening are ignored.

To indicate that a gate is used for the sweep, "GAT" and the gate source is displayed in the channel bar.

### 8.7.2.2 Gate Settings

**Access:** "Overview" > "Trigger" > "Trigger / Gate Config." > "Gate Settings"

Gate settings define one or more extracts of the signal to be measured.

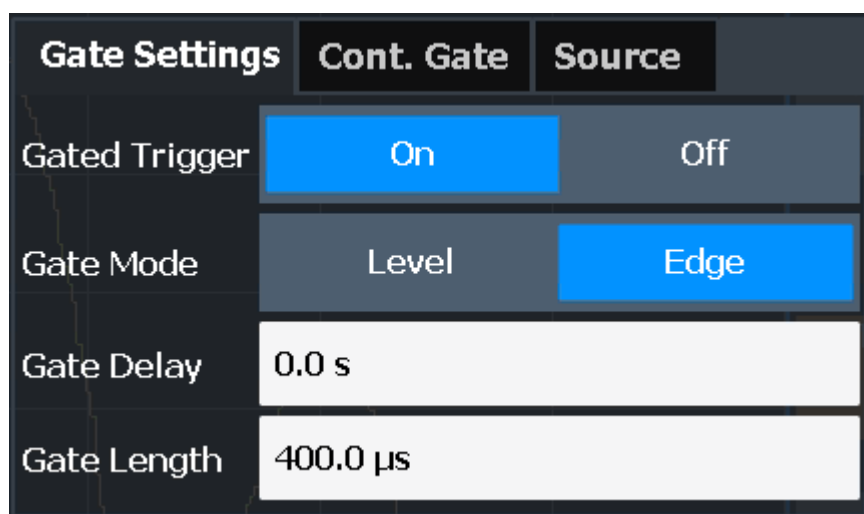

Gating is not available for measurements on I/Q-based data.

|                     |     |
|---------------------|-----|
| Gated Trigger ..... | 459 |
| Gate Mode .....     | 459 |
| Gate Delay .....    | 460 |
| Gate Length .....   | 460 |

#### Gated Trigger

Switches gated triggering on or off.

If the gate is switched on, a gate signal applied to one of the TRIGGER INPUT connectors or the internal IF power detector controls the sweep.

Remote command:

[SENSe:] SWEEp:EGATE on page 739

#### Gate Mode

Sets the gate mode.

For more information see [Chapter 8.7.2.1, "Gated Measurements"](#), on page 458

Remote command:

[SENSe:] SWEep:EGATe:TYPE on page 741

### Gate Delay

Defines the delay time between the gate signal and the continuation of the measurement.

The delay position on the time axis in relation to the sweep is indicated by a line labeled "GD" .

For more information see [Chapter 8.7.2.1, "Gated Measurements"](#), on page 458

Remote command:

[SENSe:] SWEep:EGATe:HOLDoff on page 740

### Gate Length

Defines how long the gate is open when it is triggered.

The gate length in relation to the sweep is indicated by a line labeled "GL" .

For more information see [Chapter 8.7.2.1, "Gated Measurements"](#), on page 458

Remote command:

[SENSe:] SWEep:EGATe:LENGth on page 740

## 8.7.2.3 How to Configure a Gated Measurement

A gated measurement records data only while the gate conditions are fulfilled. These step-by-step instructions demonstrate how to configure a gated measurement manually.

### To configure a common gated measurement

1. Determine the required parameters as described in [Chapter 8.7.1.3, "How to Determine the Required Trigger/Gate Parameters"](#), on page 457.
2. The gate is opened by a trigger event, which must be based on a power source. Define the trigger as described in [Chapter 8.7.1.4, "How to Configure a Triggered Measurement"](#), on page 457. As the "Trigger Source" , use "IF Power" , "Video" or "External" .
3. Define how long the gate is to remain open:  
To measure the signal as long as the trigger level is exceeded, for example for one or more pulses, define "Gate Mode" = "Level" .  
To measure the signal for a certain time after a level is exceeded, for example during a burst:
  - a) Define "Gate Mode" = "Edge" .
  - b) Define the time to measure for each gate: "Gate Length" .
4. To open the gate with a time delay, for example to ignore an overshoot, define a "Gate Delay" .
5. Select "Gated Trigger" = "On" .

## 8.8 Adjusting Settings Automatically

**Access:** "Overview" > "Amplitude" / "Frequency" > "Auto Settings"

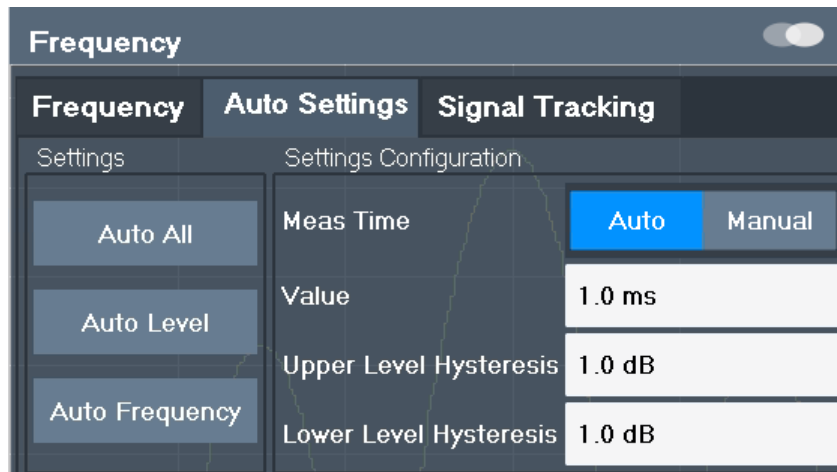

Some settings can be adjusted by the R&S FPL1000 automatically according to the current measurement settings. In order to do so, a measurement is performed. The duration of this measurement can be defined automatically or manually.



### Adjusting settings automatically during triggered measurements

When you select an auto adjust function, a measurement is performed to determine the optimal settings. If you select an auto adjust function for a triggered measurement, you are asked how the R&S FPL1000 should behave:

- (default:) The measurement for adjustment waits for the next trigger
- The measurement for adjustment is performed without waiting for a trigger. The trigger source is temporarily set to "Free Run". After the measurement is completed, the original trigger source is restored. The trigger level is adjusted as follows:
  - For IF Power and RF Power triggers:  
Trigger Level = Reference Level - 15 dB
  - For Video trigger:  
Trigger Level = 85 %

#### Remote command:

[SENSe:]ADJust:CONFigure:TRIGger on page 719

|                                                                      |     |
|----------------------------------------------------------------------|-----|
| Adjusting all Determinable Settings Automatically ( Auto All ).....  | 462 |
| Adjusting the Center Frequency Automatically ( Auto Frequency )..... | 462 |
| Setting the Reference Level Automatically ( Auto Level ).....        | 462 |
| Resetting the Automatic Measurement Time ( Meastime Auto ).....      | 462 |
| Changing the Automatic Measurement Time ( Meastime Manual ).....     | 462 |
| Upper Level Hysteresis .....                                         | 463 |
| Lower Level Hysteresis .....                                         | 463 |

**Adjusting all Determinable Settings Automatically ( Auto All )**

Activates all automatic adjustment functions for the current measurement settings.

This includes:

- [Auto Frequency](#)
- [Auto Level](#)

Remote command:

`[SENSe:]ADJust:ALL` on page 717

**Adjusting the Center Frequency Automatically ( Auto Frequency )**

The R&S FPL1000 adjusts the center frequency automatically.

The optimum center frequency is the frequency with the highest S/N ratio in the frequency span. As this function uses the signal counter, it is intended for use with sinusoidal signals.

At the same time, the optimal reference level is also set (see "[Setting the Reference Level Automatically \( Auto Level \)](#)" on page 431).

Remote command:

`[SENSe:]ADJust:FREquency` on page 719

**Setting the Reference Level Automatically ( Auto Level )**

Automatically determines a reference level which ensures that no overload occurs at the R&S FPL1000 for the current input data. At the same time, the internal attenuators are adjusted so the signal-to-noise ratio is optimized, while signal compression and clipping are minimized.

To determine the required reference level, a level measurement is performed on the R&S FPL1000.

If necessary, you can optimize the reference level further. Decrease the attenuation level manually to the lowest possible value before an overload occurs, then decrease the reference level in the same way.

You can change the measurement time for the level measurement if necessary (see "[Changing the Automatic Measurement Time \( Meastime Manual \)](#)" on page 462).

Remote command:

`[SENSe:]ADJust:LEVel` on page 719

**Resetting the Automatic Measurement Time ( Meastime Auto )**

Resets the measurement duration for automatic settings to the default value.

(Spectrum application: 1 ms)

Remote command:

`[SENSe:]ADJust:CONFigure:DURation:MODE` on page 718

**Changing the Automatic Measurement Time ( Meastime Manual )**

This function allows you to change the measurement duration for automatic setting adjustments. Enter the value in seconds.

**Note:** The maximum possible measurement duration depends on the currently selected measurement and the installed (optional) hardware. Thus, the measurement duration actually used to determine the automatic settings may be shorter than the value you define here.

Remote command:

[\[SENSe:\]ADJust:CONFigure:DURation:MODE](#) on page 718

[\[SENSe:\]ADJust:CONFigure:DURation](#) on page 717

### Upper Level Hysteresis

When the reference level is adjusted automatically using the [Auto Level](#) function, the internal attenuators and the preamplifier are also adjusted. To avoid frequent adaptation due to small changes in the input signal, you can define a hysteresis. This setting defines an upper threshold the signal must exceed (compared to the last measurement) before the reference level is adapted automatically.

Remote command:

[\[SENSe:\]ADJust:CONFigure:HYSTeresis:UPPer](#) on page 718

### Lower Level Hysteresis

When the reference level is adjusted automatically using the [Auto Level](#) function, the internal attenuators and the preamplifier are also adjusted. To avoid frequent adaptation due to small changes in the input signal, you can define a hysteresis. This setting defines a lower threshold the signal must fall below (compared to the last measurement) before the reference level is adapted automatically.

Remote command:

[\[SENSe:\]ADJust:CONFigure:HYSTeresis:LOWer](#) on page 718

## 8.9 Marker Usage

Markers help you analyze your measurement results by determining particular values in the diagram. Thus you can extract numeric values from a graphical display both in the time and frequency domain. In addition to basic markers, sophisticated marker functions are provided for special results such as noise or demodulation.



### Markers in Spectrogram Displays

In the spectrogram result display, you can activate up to 16 markers or delta markers at the same time. Each marker can be assigned to a different frame. Therefore, in addition to the frequency you also define the frame number when activating a new marker. If no frame number is specified, the marker is positioned on the currently selected frame. All markers are visible that are positioned on a visible frame.

- [Basics on Markers](#).....464
- [Marker Settings](#).....466
- [Marker Search Settings and Positioning Functions](#)..... 472
- [Marker \(Measurement\) Functions](#).....479
- [How to Work With Markers](#)..... 500
- [Measurement Example: Measuring Harmonics Using Marker Functions](#)..... 501

### 8.9.1 Basics on Markers

Some background knowledge on marker settings and functions is provided here for a better understanding of the required configuration settings.

Markers are used to mark points on traces, to read out measurement results and to select a display section quickly. R&S FPL1000 provides 16 markers per display window. In the Spectrum application, the same markers are displayed in all windows.

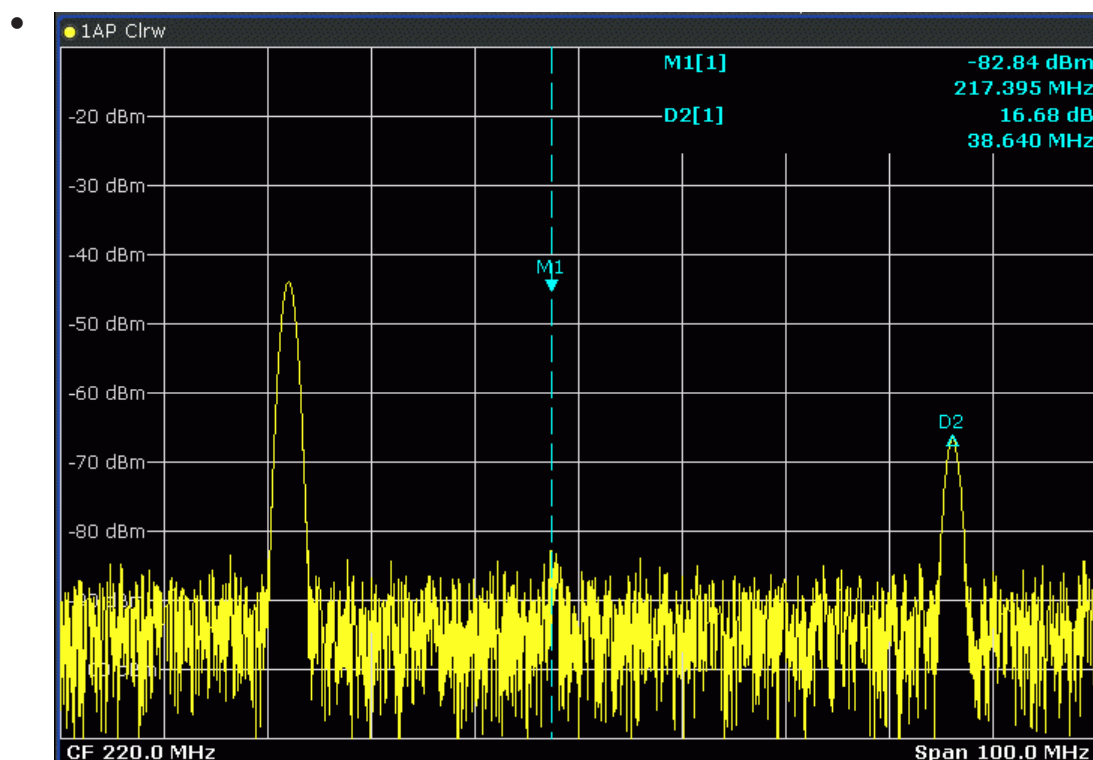

- Alternatively, change the position of the selected marker using the rotary knob. By default, the marker is moved from one pixel to the next. If you need to position the marker more precisely, change the step size to move from one sweep point to the next (General Marker Setting).
  - You can also set an active marker to a new position by defining its x-position numerically. When you select the softkey for a marker, an edit dialog box is displayed.
  - The most commonly required marker settings and functions are also available as softkeys or via the context menu. Tap the marker on the touch screen and hold your finger for about 2 seconds until the context menu is opened, then select the required entry.
  - Softkeys for active markers (displayed on the screen) are highlighted blue. The softkey for the currently selected marker (for which functions are performed) is highlighted orange.
  - To set individual markers very quickly, use the softkeys in the "Marker" menu.
  - To set up several markers at once, use the "Marker" dialog box.
  - To position the selected marker to a special value, use the softkeys in the "Marker To" menu.



- To determine more sophisticated marker results, use the special functions in the "Marker Function" dialog box.

In addition to basic markers, sophisticated marker functions are provided for special results such as noise or band power measurements.

- [Marker Types](#)..... 465
- [Activating Markers](#).....465
- [Marker Results](#).....465

### 8.9.1.1 Marker Types

All markers can be used either as normal markers or delta markers. A normal marker indicates the absolute signal value at the defined position in the diagram. A delta marker indicates the value of the marker relative to the specified reference marker (by default marker 1).

In addition, special functions can be assigned to the individual markers. The availability of special marker functions depends on whether the measurement is performed in the frequency or time domain, and on the type of measurement.

Temporary markers are used in addition to the markers and delta markers to analyze the measurement results for special marker functions. They disappear when the associated function is deactivated.

### 8.9.1.2 Activating Markers

Only active markers are displayed in the diagram and in the marker table.

Active markers are indicated by a highlighted softkey.

By default, marker 1 is active and positioned on the maximum value (peak) of trace 1 as a normal marker. If several traces are displayed, the marker is set to the maximum value of the trace which has the lowest number and is not frozen (View mode). The next marker to be activated is set to the frequency of the next lower level (next peak) as a delta marker; its value is indicated as an offset to marker 1.

A marker can only be activated when at least one trace in the corresponding window is visible. If a trace is switched off, the corresponding markers and marker functions are also deactivated. If the trace is switched on again, the markers along with coupled functions are restored to their original positions, provided the markers have not been used on another trace.

### 8.9.1.3 Marker Results

Normal markers point to a sweep point on the time or frequency axis and display the associated numeric value for that sweep point. Delta markers indicate an offset between the level at the delta marker position and the level at the position of the assigned reference marker, in dB.

Signal count markers determine the frequency of a signal at the marker position very accurately.

The results can be displayed directly within the diagram area or in a separate table. By default, the first two active markers are displayed in the diagram area. If more markers are activated, the results are displayed in a marker table.

### Marker information in diagram area

By default, the results of the last two markers or delta markers that were activated are displayed in the diagram area.

|       |             |
|-------|-------------|
| D2[1] | -21.90 dB   |
|       | -3.9180 GHz |
| M1[1] | -25.87 dBm  |
|       | 13.1970 GHz |

The following information is displayed there:

- The marker type (M for normal, D for delta, or special function name)
- The marker number (1 to 16)
- The assigned trace number in square brackets [ ]
- The marker value on the y-axis, or the result of the marker function
- The marker position on the x-axis

For n dB down markers, additional information is displayed, see [Table 8-24](#).

### Marker information in marker table

In addition to the marker information displayed within the diagram area, a separate marker table may be displayed beneath the diagram. This table provides the following information for all active markers:

|                        |                                                                                                  |
|------------------------|--------------------------------------------------------------------------------------------------|
| <b>Type</b>            | Marker type: N (normal), D (delta), T (temporary, internal) and number                           |
| <b>Ref</b>             | Reference marker for delta markers                                                               |
| <b>Trc</b>             | Trace to which the marker is assigned                                                            |
| <b>Frame</b>           | Spectrogram frame the marker is positioned in. Displayed only when the Spectrogram is displayed. |
| <b>X-value</b>         | X-value of the marker                                                                            |
| <b>Y-value</b>         | Y-value of the marker                                                                            |
| <b>Function</b>        | Activated marker or measurement function                                                         |
| <b>Function Result</b> | Result of the active marker or measurement function                                              |

## 8.9.2 Marker Settings

Or: [MKR] > "Marker Config"

The remote commands required to define these settings are described in [Chapter 9.8.8.1, "Setting Up Individual Markers"](#), on page 784.

- [Individual Marker Setup](#)..... 467
- [General Marker Settings](#)..... 470

### 8.9.2.1 Individual Marker Setup

Up to 17 markers or delta markers can be activated for each window simultaneously. Initial marker setup is performed using the "Marker" dialog box.

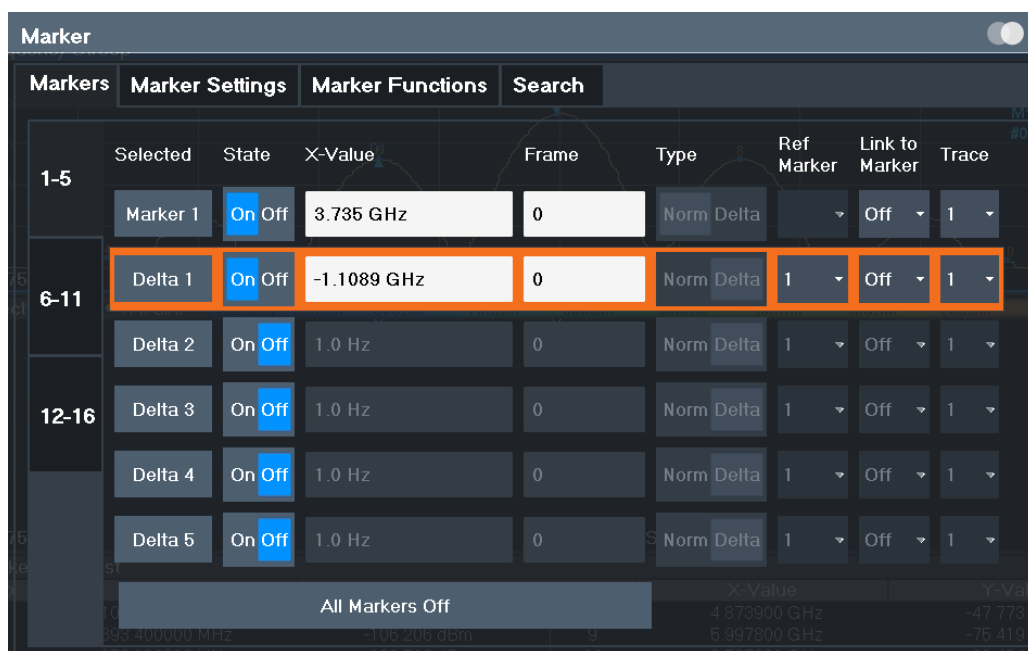

The markers are distributed among 3 tabs for a better overview. By default, the first marker is defined as a normal marker, whereas all others are defined as delta markers with reference to the first marker. All markers are assigned to trace 1, but only the first marker is active.

- [Selected Marker](#) ..... 467
- [Marker State](#) ..... 468
- [Marker Position X-value](#) ..... 468
- [Frame \(Spectrogram only\)](#)..... 468
- [Marker Type](#) ..... 468
- [Reference Marker](#) ..... 468
- [Linking to Another Marker](#) ..... 469
- [Assigning the Marker to a Trace](#) ..... 469
- [Select Marker](#) ..... 469
- [All Marker Off](#) ..... 470

#### Selected Marker

Marker name. The marker which is currently selected for editing is highlighted orange.

Remote command:

Marker selected via suffix <m> in remote commands.

**Marker State**

Activates or deactivates the marker in the diagram.

Remote command:

[CALCulate<n>:MARKer<m>\[:STATe\]](#) on page 789

[CALCulate<n>:DELTAmarker<m>\[:STATe\]](#) on page 787

**Marker Position X-value**

Defines the position (x-value) of the marker in the diagram. For normal markers, the absolute position is indicated. For delta markers, the position relative to the reference marker is provided.

Remote command:

[CALCulate<n>:MARKer<m>:X](#) on page 789

[CALCulate<n>:DELTAmarker<m>:X](#) on page 787

**Frame (Spectrogram only)**

Spectrogram frame the marker is assigned to.

Remote command:

[CALCulate<n>:MARKer<m>:SPECTrogram:FRAME](#) on page 804

[CALCulate<n>:DELTAmarker<m>:SPECTrogram:FRAME](#) on page 809

**Marker Type**

Toggles the marker type.

The type for marker 1 is always "Normal", the type for delta marker 1 is always "Delta". These types cannot be changed.

**Note:** If normal marker 1 is the active marker, switching the "Mkr Type" activates an additional delta marker 1. For any other marker, switching the marker type does not activate an additional marker, it only switches the type of the selected marker.

"Normal"            A normal marker indicates the absolute value at the defined position in the diagram.

"Delta"            A delta marker defines the value of the marker relative to the specified reference marker (marker 1 by default).

Remote command:

[CALCulate<n>:MARKer<m>\[:STATe\]](#) on page 789

[CALCulate<n>:DELTAmarker<m>\[:STATe\]](#) on page 787

**Reference Marker**

Defines a marker as the reference marker which is used to determine relative analysis results (delta marker values).

If the reference marker is deactivated, the delta marker referring to it is also deactivated.

If a fixed reference point is configured (see ["Defining a Fixed Reference"](#) on page 471), the reference point ("FXD") can also be selected instead of another marker.

Remote command:

[CALCulate<n>:DELTAmarker<m>:MREference](#) on page 786

### Linking to Another Marker

Links the current marker to the marker selected from the list of active markers. If the x-axis value of the initial marker is changed, the linked marker follows to the same position on the x-axis. Linking is off by default.

Using this function you can set two markers on different traces to measure the difference (e.g. between a max hold trace and a min hold trace or between a measurement and a reference trace).

Remote command:

[CALCulate<n>:MARKer<ms>:LINK:TO:MARKer<md>](#) on page 788

[CALCulate<n>:DELTamarker<ms>:LINK:TO:MARKer<md>](#) on page 785

[CALCulate<n>:DELTamarker<m>:LINK](#) on page 785

### Assigning the Marker to a Trace

The "Trace" setting assigns the selected marker to an active trace. The trace determines which value the marker shows at the marker position. If the marker was previously assigned to a different trace, the marker remains on the previous frequency or time, but indicates the value of the new trace.

If a trace is turned off, the assigned markers and marker functions are also deactivated.

Remote command:

[CALCulate<n>:MARKer<m>:TRACe](#) on page 789

### Select Marker

The "Select Marker" function opens a dialog box to select and activate or deactivate one or more markers quickly.

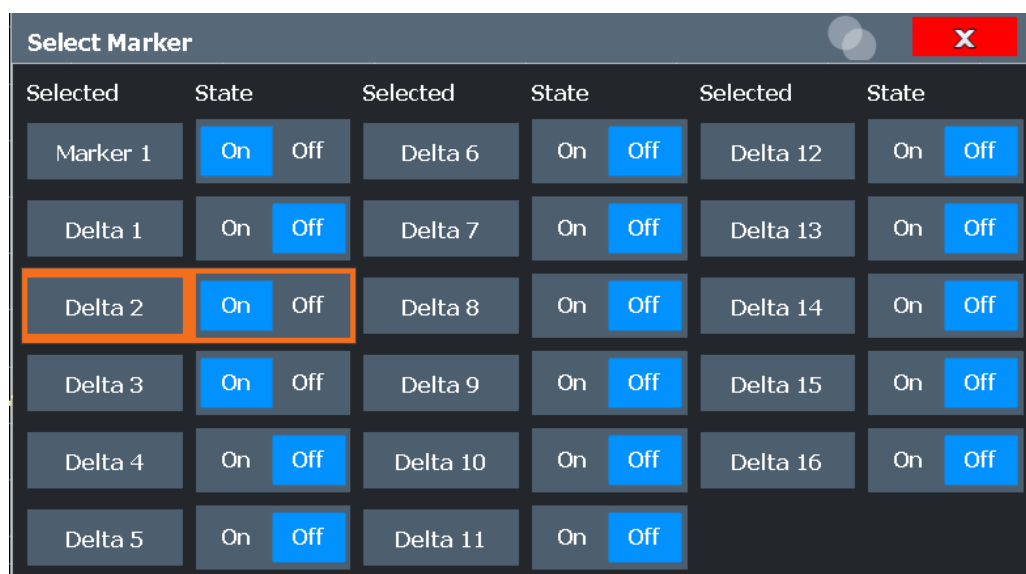

Remote command:

[CALCulate<n>:MARKer<m>\[:STATe\]](#) on page 789

[CALCulate<n>:DELTamarker<m>\[:STATe\]](#) on page 787

**All Marker Off**

Deactivates all markers in one step.

Remote command:

CALCulate<n>:MARKer<m>:AOFF on page 788

**8.9.2.2 General Marker Settings**

Some general marker settings allow you to influence the marker behavior for all markers.

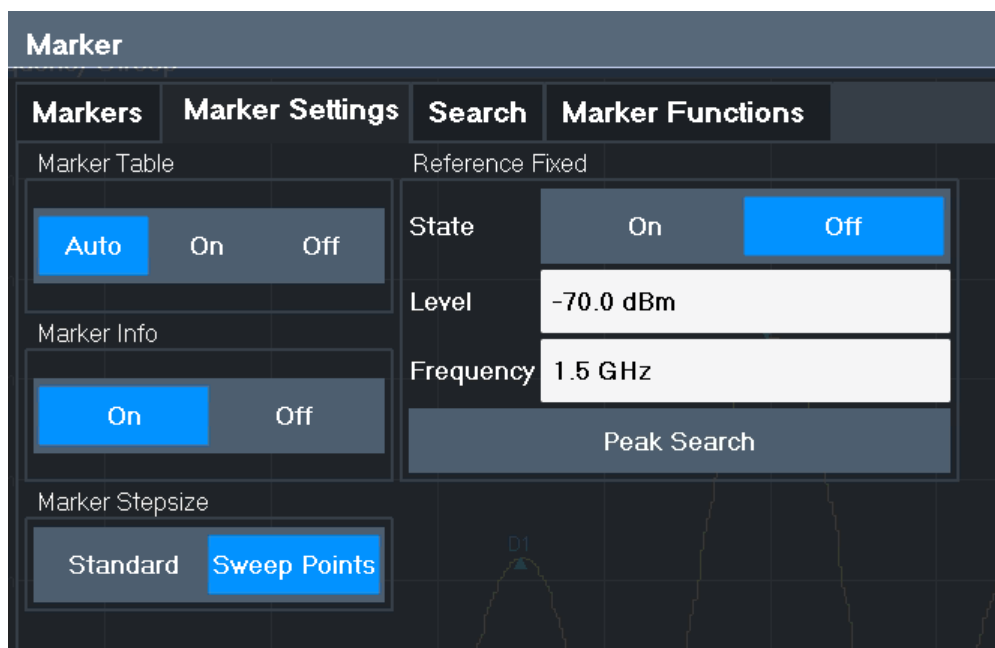

Marker Table Display .....470  
 Marker Info .....471  
 Marker Stepsize .....471  
 Defining a Fixed Reference.....471

**Marker Table Display**

Defines how the marker information is displayed.

- "On" Displays the marker information in a table in a separate area beneath the diagram.
- "Off" No separate marker table is displayed. If **Marker Info** is active, the marker information is displayed within the diagram area.
- "Auto" (Default) If more than two markers are active, the marker table is displayed automatically. If **Marker Info** is active, the marker information for up to two markers is displayed in the diagram area.

Remote command:

DISPlay[:WINDow<n>]:MTABLE on page 790

**Marker Info**

Turns the marker information displayed in the diagram on and off.

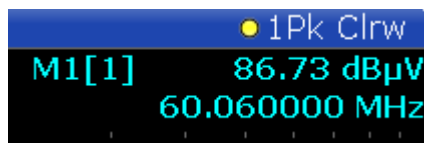

Remote command:

`DISPlay[:WINDow<n>]:MINFo[:STATe]` on page 791

**Marker Stepsize**

Defines the size of the steps that the marker position is moved using the rotary knob.

- |                |                                                                                                                                                                                                                                                  |
|----------------|--------------------------------------------------------------------------------------------------------------------------------------------------------------------------------------------------------------------------------------------------|
| "Standard"     | The marker position is moved in steps of (Span/1000), which corresponds approximately to the number of pixels for the default display of 1001 sweep points. This setting is most suitable to move the marker over a larger distance.             |
| "Sweep Points" | The marker position is moved from one sweep point to the next. This setting is required for a very precise positioning if more sweep points are collected than the number of pixels that can be displayed on the screen. It is the default mode. |

Remote command:

`CALCulate<n>:MARKer<m>:X:SSIZE` on page 791

**Defining a Fixed Reference**

Instead of using a reference marker that may vary its position depending on the measurement results, a fixed reference marker can be defined for trace analysis.

Note that this function may not be available in all result displays.

For "State" = "On", a vertical and a horizontal red display line are displayed, marked as "FXD". The normal marker 1 is activated and set to the peak value of the trace assigned to marker 1, and a delta marker to the next peak. The fixed reference marker is set to the position of marker 1 at the peak value. The delta marker refers to the fixed reference marker.

The "Level" and "Frequency" or "Time" settings define the position and value of the reference marker. To move the fixed reference, move the red display lines marked "FXD" in the diagram, or change the position settings in the "Marker Settings" tab of the "Marker" dialog box.

**Peak Search** sets the fixed reference marker to the current maximum value of the trace assigned to marker 1.

If activated, the fixed reference marker ("FXD") can also be selected as a [Reference Marker](#) instead of another marker.

Remote command:

`CALCulate<n>:DELTaMarker<m>:FUNction:FIXed[:STATe]` on page 814

`CALCulate<n>:DELTaMarker<m>:FUNction:FIXed:RPOint:Y` on page 813

`CALCulate<n>:DELTaMarker<m>:FUNction:FIXed:RPOint:X` on page 813

`CALCulate<n>:DELTaMarker<m>:FUNction:FIXed:RPOint:MAXimum[:PEAK]` on page 812

### 8.9.3 Marker Search Settings and Positioning Functions

**Access:** "Overview" > "Analysis" > "Marker" > "Search"

**or:** [MKR TO]

Several functions are available to set the marker to a specific position very quickly and easily, or to use the current marker position to define another characteristic value. In order to determine the required marker position, searches may be performed. The search results can be influenced by special settings.

For more information on searching for signal peaks see [Chapter 8.9.4.8, "Marker Peak List"](#), on page 495.

The remote commands required to define these settings are described in [Chapter 9.8.8.4, "Positioning the Marker"](#), on page 795.

- [Marker Search Settings](#).....472
- [Marker Search Settings for Spectrograms](#).....474
- [Positioning Functions](#).....478

#### 8.9.3.1 Marker Search Settings

**Access:** [MKR TO] > "Search Config"

Markers are commonly used to determine peak values, i.e. maximum or minimum values, in the measured signal. Configuration settings allow you to influence the peak search results.



For Spectrograms, special marker settings are available, see [Chapter 8.9.3.2, "Marker Search Settings for Spectrograms"](#), on page 474.

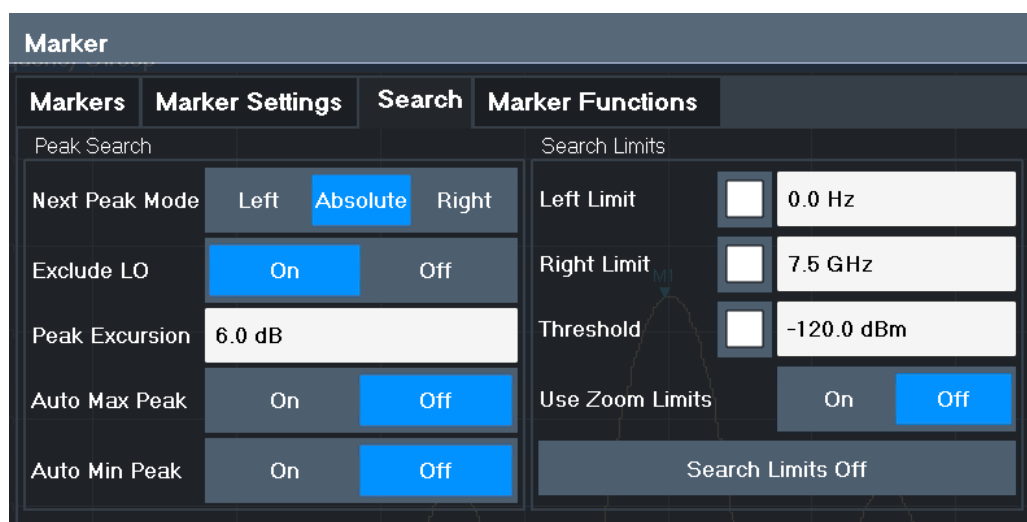

- [Search Mode for Next Peak](#) .....473
- [Exclude LO](#) .....473
- [Peak Excursion](#) .....473



|                                                   |     |
|---------------------------------------------------|-----|
| Auto Max Peak Search / Auto Min Peak Search ..... | 473 |
| Search Limits .....                               | 474 |
| L Search Limits ( Left / Right ) .....            | 474 |
| L Search Threshold .....                          | 474 |
| L Use Zoom Limits .....                           | 474 |
| L Deactivating All Search Limits .....            | 474 |

### Search Mode for Next Peak

Selects the search mode for the next peak search.

|            |                                                                         |
|------------|-------------------------------------------------------------------------|
| "Left"     | Determines the next maximum/minimum to the left of the current peak.    |
| "Absolute" | Determines the next maximum/minimum to either side of the current peak. |
| "Right"    | Determines the next maximum/minimum to the right of the current peak.   |

Remote command:

[Chapter 9.8.8.4, "Positioning the Marker"](#), on page 795

### Exclude LO

If activated, restricts the frequency range for the marker search functions.

|       |                                                                                                                                                                                                                                                                                                                                                                                |
|-------|--------------------------------------------------------------------------------------------------------------------------------------------------------------------------------------------------------------------------------------------------------------------------------------------------------------------------------------------------------------------------------|
| "On"  | The minimum frequency included in the peak search range is $\geq 5 \times$ resolution bandwidth (RBW).<br>Due to the interference by the first local oscillator to the first intermediate frequency at the input mixer, the LO is represented as a signal at 0 Hz. To avoid the peak marker jumping to the LO signal at 0 Hz, this frequency is excluded from the peak search. |
| "Off" | No restriction to the search range. The frequency 0 Hz is included in the marker search functions.                                                                                                                                                                                                                                                                             |

Remote command:

`CALCulate<n>:MARKer<m>:LOEXclude` on page 792

### Peak Excursion

Defines the minimum level value by which a signal must rise or fall so that it is identified as a maximum or a minimum by the search functions.

Entries from 0 dB to 80 dB are allowed; the resolution is 0.1 dB. The default setting for the peak excursion is 6 dB.

For analog demodulation, the unit and value range depend on the selected result display type.

For more information, see [Chapter 8.9.4.8, "Marker Peak List"](#), on page 495.

Remote command:

`CALCulate<n>:MARKer<m>:PEXCursion` on page 792

### Auto Max Peak Search / Auto Min Peak Search

If activated, a maximum or minimum peak search is performed automatically for marker 1 after each sweep.

For spectrogram displays, define which frame the peak is to be searched in.

Remote command:

`CALCulate<n>:MARKer<m>:MAXimum:AUTO` on page 796

`CALCulate<n>:MARKer<m>:MINimum:AUTO` on page 797

### Search Limits

The search results can be restricted by limiting the search area or adding search conditions.

#### Search Limits ( Left / Right ) ← Search Limits

If activated, limit lines are defined and displayed for the search. Only results within the limited search range are considered.

For details on limit lines for searches, see "[Peak search limits](#)" on page 496.

Remote command:

`CALCulate<n>:MARKer<m>:X:SLIMits[:STATe]` on page 793

`CALCulate<n>:MARKer<m>:X:SLIMits:LEFT` on page 793

`CALCulate<n>:MARKer<m>:X:SLIMits:RIGHT` on page 794

#### Search Threshold ← Search Limits

Defines an absolute threshold as an additional condition for the peak search. Only peaks that exceed the threshold are detected.

Remote command:

`CALCulate<n>:THReshold` on page 795

#### Use Zoom Limits ← Search Limits

If activated, the peak search is restricted to the active zoom area defined for a single zoom.

Remote command:

`CALCulate<n>:MARKer<m>:X:SLIMits:ZOOM[:STATe]` on page 794

#### Deactivating All Search Limits ← Search Limits

Deactivates the search range limits.

Remote command:

`CALCulate<n>:MARKer<m>:X:SLIMits[:STATe]` on page 793

`CALCulate<n>:THReshold:STATe` on page 795

### 8.9.3.2 Marker Search Settings for Spectrograms

**Access:** "Overview" > "Analysis" > "Markers" > "Search"

**or:** [MKR TO] > "Search Config"

Spectrograms show not only the current sweep results, but also the sweep history. Thus, when searching for peaks, you must define the search settings within a single time frame (x-direction) and within several time frames (y-direction).

These settings are only available for spectrogram displays.

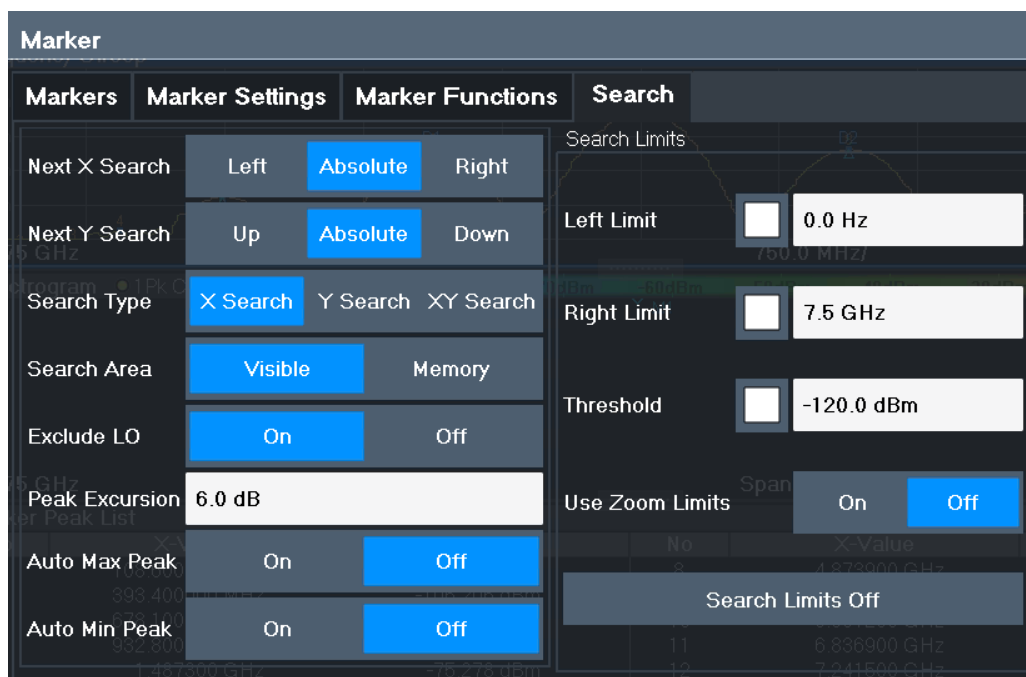

Search Mode for Next Peak in X-Direction ..... 475

Search Mode for Next Peak in Y-Direction ..... 475

Marker Search Type ..... 476

Marker Search Area ..... 476

Exclude LO ..... 476

Peak Excursion ..... 477

Auto Max Peak Search / Auto Min Peak Search ..... 477

Search Limits ..... 477

- └ Search Limits ( Left / Right ) ..... 477
- └ Search Threshold ..... 477
- └ Use Zoom Limits ..... 478
- └ Deactivating All Search Limits ..... 478

**Search Mode for Next Peak in X-Direction**

Selects the search mode for the next peak search within the currently selected frame.

- "Left" Determines the next maximum/minimum to the left of the current peak.
- "Absolute" Determines the next maximum/minimum to either side of the current peak.
- "Right" Determines the next maximum/minimum to the right of the current peak.

Remote command:

[Chapter 9.8.8.4, "Positioning the Marker"](#), on page 795

**Search Mode for Next Peak in Y-Direction**

Selects the search mode for the next peak search within all frames at the current marker position.

|            |                                                                                      |
|------------|--------------------------------------------------------------------------------------|
| "Up"       | Determines the next maximum/minimum above the current peak (in more recent frames).  |
| "Absolute" | Determines the next maximum/minimum above or below the current peak (in all frames). |
| "Down"     | Determines the next maximum/minimum below the current peak (in older frames).        |

Remote command:

[CALCulate<n>:MARKer<m>:SPECTrogram:Y:MAXimum:ABOVE](#) on page 805

[CALCulate<n>:DELTamarker<m>:SPECTrogram:Y:MAXimum:ABOVE](#)  
on page 810

[CALCulate<n>:MARKer<m>:SPECTrogram:Y:MAXimum:BELOW](#) on page 806

[CALCulate<n>:DELTamarker<m>:SPECTrogram:Y:MAXimum:BELOW](#)  
on page 810

[CALCulate<n>:MARKer<m>:SPECTrogram:Y:MAXimum:NEXT](#) on page 806

[CALCulate<n>:DELTamarker<m>:SPECTrogram:Y:MAXimum:NEXT](#) on page 811

[CALCulate<n>:MARKer<m>:SPECTrogram:Y:MINimum:ABOVE](#) on page 806

[CALCulate<n>:DELTamarker<m>:SPECTrogram:Y:MINimum:ABOVE](#)  
on page 811

[CALCulate<n>:MARKer<m>:SPECTrogram:Y:MINimum:BELOW](#) on page 807

[CALCulate<n>:DELTamarker<m>:SPECTrogram:Y:MINimum:BELOW](#)  
on page 811

[CALCulate<n>:MARKer<m>:SPECTrogram:Y:MINimum:NEXT](#) on page 807

[CALCulate<n>:DELTamarker<m>:SPECTrogram:Y:MINimum:NEXT](#) on page 812

### Marker Search Type

Defines the type of search to be performed in the spectrogram.

"X-Search" Searches only within the currently selected frame.

"Y-Search" Searches within all frames but only at the current frequency position.

"XY-Search" Searches in all frames at all positions.

Remote command:

Defined by the search function, see [Chapter 9.8.8.6, "Marker Search \(Spectrograms\)"](#), on page 803

### Marker Search Area

Defines which frames the search is performed in.

"Visible" Only the visible frames are searched.

"Memory" All frames stored in the memory are searched.

Remote command:

[CALCulate<n>:MARKer<m>:SPECTrogram:SARea](#) on page 805

[CALCulate<n>:DELTamarker<m>:SPECTrogram:SARea](#) on page 809

### Exclude LO

If activated, restricts the frequency range for the marker search functions.

- "On" The minimum frequency included in the peak search range is  $\geq 5 \times$  resolution bandwidth (RBW).  
Due to the interference by the first local oscillator to the first intermediate frequency at the input mixer, the LO is represented as a signal at 0 Hz. To avoid the peak marker jumping to the LO signal at 0 Hz, this frequency is excluded from the peak search.
- "Off" No restriction to the search range. The frequency 0 Hz is included in the marker search functions.

Remote command:

[CALCulate<n>:MARKer<m>:LOEXclude](#) on page 792

### Peak Excursion

Defines the minimum level value by which a signal must rise or fall so that it is identified as a maximum or a minimum by the search functions.

Entries from 0 dB to 80 dB are allowed; the resolution is 0.1 dB. The default setting for the peak excursion is 6 dB.

For analog demodulation, the unit and value range depend on the selected result display type.

For more information, see [Chapter 8.9.4.8, "Marker Peak List"](#), on page 495.

Remote command:

[CALCulate<n>:MARKer<m>:PEXCursion](#) on page 792

### Auto Max Peak Search / Auto Min Peak Search

If activated, a maximum or minimum peak search is performed automatically for marker 1 after each sweep.

For spectrogram displays, define which frame the peak is to be searched in.

Remote command:

[CALCulate<n>:MARKer<m>:MAXimum:AUTO](#) on page 796

[CALCulate<n>:MARKer<m>:MINimum:AUTO](#) on page 797

### Search Limits

The search results can be restricted by limiting the search area or adding search conditions.

#### Search Limits ( Left / Right ) ← Search Limits

If activated, limit lines are defined and displayed for the search. Only results within the limited search range are considered.

For details on limit lines for searches, see ["Peak search limits"](#) on page 496.

Remote command:

[CALCulate<n>:MARKer<m>:X:SLIMits\[:STATe\]](#) on page 793

[CALCulate<n>:MARKer<m>:X:SLIMits:LEFT](#) on page 793

[CALCulate<n>:MARKer<m>:X:SLIMits:RIGHT](#) on page 794

#### Search Threshold ← Search Limits

Defines an absolute threshold as an additional condition for the peak search. Only peaks that exceed the threshold are detected.

Remote command:

`CALCulate<n>:THReshold` on page 795

### Use Zoom Limits ← Search Limits

If activated, the peak search is restricted to the active zoom area defined for a single zoom.

Remote command:

`CALCulate<n>:MARKer<m>:X:SLIMits:ZOOM[:STATe]` on page 794

### Deactivating All Search Limits ← Search Limits

Deactivates the search range limits.

Remote command:

`CALCulate<n>:MARKer<m>:X:SLIMits[:STATe]` on page 793

`CALCulate<n>:THReshold:STATe` on page 795

## 8.9.3.3 Positioning Functions

**Access:** [MKR ->]

The following functions set the currently selected marker to the result of a peak search or set other characteristic values to the current marker value.

|                                           |     |
|-------------------------------------------|-----|
| Peak Search .....                         | 478 |
| Search Next Peak .....                    | 478 |
| Search Minimum .....                      | 479 |
| Search Next Minimum .....                 | 479 |
| Center Frequency = Marker Frequency ..... | 479 |
| Reference Level = Marker Level .....      | 479 |

### Peak Search

Sets the selected marker/delta marker to the maximum of the trace. If no marker is active, marker 1 is activated.

For spectrogram displays, define which frame the peak is to be searched in.

Remote command:

`CALCulate<n>:MARKer<m>:MAXimum[:PEAK]` on page 797

`CALCulate<n>:DELTamarker<m>:MAXimum[:PEAK]` on page 800

### Search Next Peak

Sets the selected marker/delta marker to the next (lower) maximum of the assigned trace. If no marker is active, marker 1 is activated.

For spectrogram displays, define which frame the next peak is to be searched in.

Remote command:

`CALCulate<n>:MARKer<m>:MAXimum:NEXT` on page 796

`CALCulate<n>:MARKer<m>:MAXimum:RIGHT` on page 797

`CALCulate<n>:MARKer<m>:MAXimum:LEFT` on page 796

`CALCulate<n>:DELTamarker<m>:MAXimum:NEXT` on page 799

`CALCulate<n>:DELTamarker<m>:MAXimum:RIGHT` on page 800

`CALCulate<n>:DELTamarker<m>:MAXimum:LEFT` on page 799

**Search Minimum**

Sets the selected marker/delta marker to the minimum of the trace. If no marker is active, marker 1 is activated.

For spectrogram displays, define which frame the minimum is to be searched in.

Remote command:

[CALCulate<n>:MARKer<m>:MINimum\[:PEAK\]](#) on page 798

[CALCulate<n>:DELTamarker<m>:MINimum\[:PEAK\]](#) on page 801

**Search Next Minimum**

Sets the selected marker/delta marker to the next (higher) minimum of the selected trace. If no marker is active, marker 1 is activated.

For spectrogram displays, define which frame the next minimum is to be searched in.

Remote command:

[CALCulate<n>:MARKer<m>:MINimum:NEXT](#) on page 798

[CALCulate<n>:MARKer<m>:MINimum:LEFT](#) on page 798

[CALCulate<n>:MARKer<m>:MINimum:RIGHT](#) on page 798

[CALCulate<n>:DELTamarker<m>:MINimum:NEXT](#) on page 800

[CALCulate<n>:DELTamarker<m>:MINimum:LEFT](#) on page 800

[CALCulate<n>:DELTamarker<m>:MINimum:RIGHT](#) on page 801

**Center Frequency = Marker Frequency**

Sets the center frequency to the selected marker or delta marker frequency. A peak can thus be set as center frequency, for example to analyze it in detail with a smaller span.

This function is not available for zero span measurements.

Remote command:

[CALCulate<n>:MARKer<m>:FUNction:CENTer](#) on page 712

**Reference Level = Marker Level**

Sets the reference level to the selected marker level.

Remote command:

[CALCulate<n>:MARKer<m>:FUNction:REFerence](#) on page 729

## 8.9.4 Marker (Measurement) Functions

**Access:** "Overview" > "Analysis" > "Marker Functions"

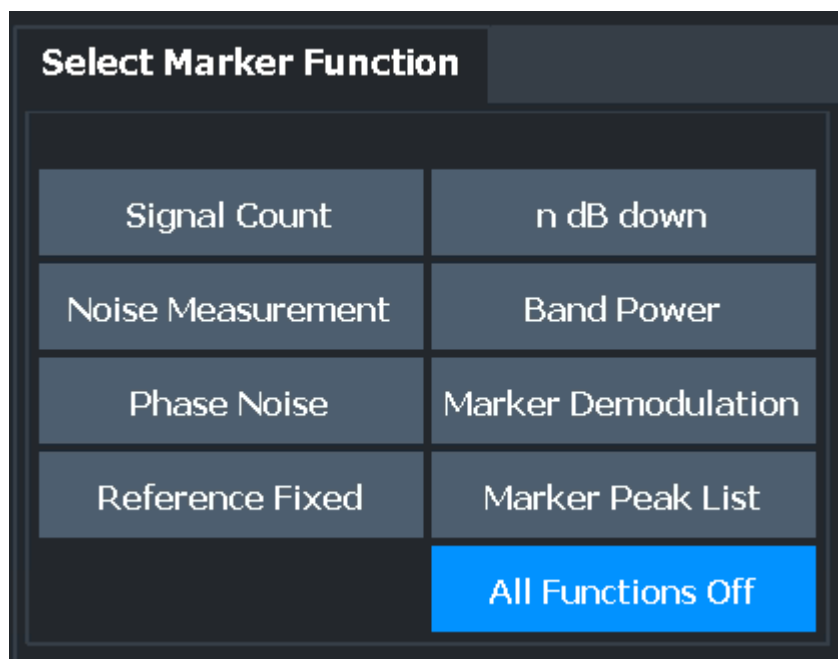

The remote commands required to define these settings are described in [Chapter 9.8.8, "Working with Markers"](#), on page 784.

- [Precise Frequency \(Signal Count\) Marker](#).....480
- [Measuring Noise Density \(Noise Meas Marker\)](#).....482
- [Phase Noise Measurement Marker](#).....484
- [Measuring Characteristic Bandwidths \(n dB Down Marker\)](#).....487
- [Fixed Reference Marker](#).....489
- [Measuring the Power in a Channel \(Band Power Marker\)](#).....490
- [Demodulating Marker Values and Providing Audio Output \(Marker Demodulation\)](#)  
.....493
- [Marker Peak List](#).....495
- [Deactivating All Marker Functions](#).....499

#### 8.9.4.1 Precise Frequency (Signal Count) Marker

**Access:** "Overview" > "Analysis" > "Marker Functions" > "Select Marker Function" > "Signal Count" > "Signal Count Config"

**Or:** [MKR] > "Select Marker Function" > "Signal Count" > "Signal Count Config"

A normal marker determines the position of the point on the trace and indicates the signal frequency at this position. The trace, however, contains only a limited number of points. Depending on the selected span, each trace point can contain many measurement values. Thus, the frequency resolution of each trace point is limited.

(See also [Chapter 8.6.1.8, "How Much Data is Measured: Sweep Points and Sweep Count"](#), on page 439).

Frequency resolution is further restricted by the RBW and sweep time settings.



To determine the frequency of a signal point accurately without changing the sweep settings, the R&S FPL1000 is equipped with a signal counter. The signal counter sets the RF to the current marker position, then counts the zero crossings of the IF (thus the term *signal counter*) and derives the precise frequency value.

Signal counting can be performed explicitly at the current marker position ( "Signal Count" marker function), or implicitly by the R&S FPL1000 for certain functions.

Signal counting is only possible while the instrument is not sweeping. Thus, to perform a signal count for a marker, the sweep is stopped at the marker position. The frequency is determined with the desired resolution and then the sweep is allowed to continue.

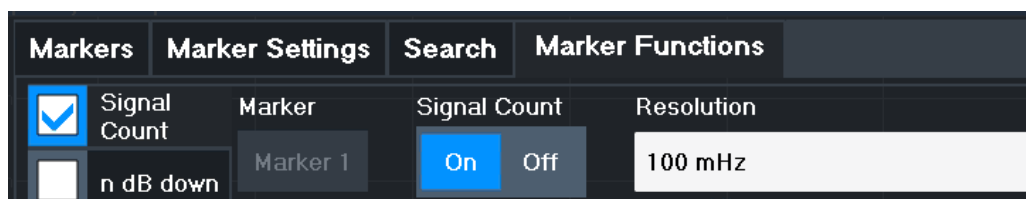

A measurement example is described in "Measuring the Signal Frequency Using the Signal Counter" on page 244.



Signal counters are not available for measurements on I/Q-based data.

**Remote commands:**

"Example: Performing a Highly Accurate Frequency Measurement Using the Signal Count Marker" on page 842

CALCulate<n>:MARKer<m>:COUNT on page 830

CALCulate<n>:MARKer<m>:COUNT:RESolution on page 831

Signal Count Marker State ..... 481  
 Resolution ..... 481

**Signal Count Marker State**

Activates or deactivates the special signal count marker function.

When activated, the sweep stops at the reference marker until the signal counter has delivered a result.

Remote command:

CALCulate<n>:MARKer<m>:COUNT on page 830

CALCulate<n>:MARKer<m>:COUNT:FREQuency? on page 830

**Resolution**

Defines the resolution with which the signal is analyzed around the reference marker 1.

Remote command:

CALCulate<n>:MARKer<m>:COUNT:RESolution on page 831

### 8.9.4.2 Measuring Noise Density (Noise Meas Marker)

**Access:** "Overview" > "Analysis" > "Marker Functions" > "Select Marker Function" > "Noise Measurement" > "Noise Meas Config"

**Or:** [MKR] > "Select Marker Function" > "Noise Measurement" > "Noise Meas Config"

Using the noise measurement marker function, the noise power density is measured at the position of the marker. In the time domain mode, all points of the trace are used to determine the noise power density. When measurements are performed in the frequency domain, eight points to the right and left of the marker (if available) are used for the measurement to obtain a stable result.

#### Result display

Noise density is the noise referred to a bandwidth of 1 Hz. With logarithmic amplitude units (dBm, dBmV, dBm $\mu$ V, dB $\mu$ A), the noise power density is output in dBm/Hz, i.e. as the level in 1 Hz bandwidth with reference to 1 mW. With linear amplitude units (V, A, W), the noise voltage density is analyzed in  $\mu$ V/ $\sqrt$ Hz; the noise current density in  $\mu$ A/ $\sqrt$ Hz; the noise power density in  $\mu$ W/ $\sqrt$ Hz.

The result is indicated as the **function result in the Marker Table**.

#### Prerequisite settings

The following settings are required to obtain correct values:

- Detector: Sample or RMS
- Video bandwidth:
  - ≤ 0.1 resolution bandwidth with sample detector
  - ≥ 3 x resolution bandwidth with RMS detector
- Trace averaging:

In the default setting, the R&S FPL1000 uses the sample detector for the noise function. With the sample detector, you can set the trace to "Average" mode to stabilize the measured values. When the RMS detector is used, trace averaging produces noise levels that are too low and cannot be corrected. Instead, increase the sweep time to obtain stable measurement results.

#### Correction factors

The R&S FPL1000 uses the following correction factors to analyze the noise density from the marker level:

- Since the noise power is indicated with reference to 1 Hz bandwidth, the bandwidth correction value is deducted from the marker level. It is  $10 \times \lg(1 \text{ Hz}/\text{BW}_{\text{Noise}})$ , where  $\text{BW}_{\text{Noise}}$  is the noise or power bandwidth of the set resolution filter (RBW).
- RMS detector: With the exception of bandwidth correction, no further corrections are required since this detector already indicates the power for each point of the trace.
- Sample detector: As a result of video filter averaging and trace averaging, 1.05 dB is added to the marker level. This is the difference between the average value and the RMS value of white noise. With a logarithmic level axis, 1.45 dB is added addi-

tionally. Logarithmic averaging is thus fully taken into account, which yields a value that is 1.45 dB lower than that of linear averaging.

- To allow for a more stable noise display, eight trace points on each side of the measurement frequency are averaged.
- For span > 0, the measured values are averaged versus time (after a sweep).



The R&S FPL1000 noise figure can be calculated from the measured power density level. It is calculated by deducting the set RF attenuation (RF Att) from the displayed noise level and adding 174 to the result.

The individual marker settings correspond to those defined in the "Marker" dialog box (see [Chapter 8.9.2.1, "Individual Marker Setup"](#), on page 467). Any settings to the marker state or type changed in the "Marker Function" dialog box are also changed in the "Marker" dialog box and vice versa.

| Marker   | State  | Type       | Noise Measurement |
|----------|--------|------------|-------------------|
| Marker 1 | On Off | Norm Delta | On Off            |
| Delta 1  | On Off | Norm Delta | On Off            |
| Delta 2  | On Off | Norm Delta | On Off            |
| Delta 3  | On Off | Norm Delta | On Off            |
| Delta 4  | On Off | Norm Delta | On Off            |
| Delta 5  | On Off | Norm Delta | On Off            |

All Noise Markers Off

#### Remote commands:

"Example: Measuring Noise Density" on page 838

`CALCulate<n>:MARKer<m>:FUNCTION:NOISe[:STATe]` on page 819

`CALCulate<n>:MARKer<m>:FUNCTION:NOISe:RESult?` on page 818

|                                           |     |
|-------------------------------------------|-----|
| Marker State .....                        | 484 |
| Marker Type .....                         | 484 |
| Noise Measurement State .....             | 484 |
| Switching All Noise Measurement Off ..... | 484 |

### Marker State

Activates or deactivates the marker in the diagram.

Remote command:

`CALCulate<n>:MARKer<m>[:STATe]` on page 789

`CALCulate<n>:DELTAmarker<m>[:STATe]` on page 787

### Marker Type

Toggles the marker type.

The type for marker 1 is always "Normal", the type for delta marker 1 is always "Delta". These types cannot be changed.

**Note:** If normal marker 1 is the active marker, switching the "Mkr Type" activates an additional delta marker 1. For any other marker, switching the marker type does not activate an additional marker, it only switches the type of the selected marker.

"Normal"            A normal marker indicates the absolute value at the defined position in the diagram.

"Delta"            A delta marker defines the value of the marker relative to the specified reference marker (marker 1 by default).

Remote command:

`CALCulate<n>:MARKer<m>[:STATe]` on page 789

`CALCulate<n>:DELTAmarker<m>[:STATe]` on page 787

### Noise Measurement State

Activates or deactivates noise measurement for the marker in the diagram.

This function is only available for normal markers.

If activated, the marker displays the noise power density measured at the position of the marker.

For details see [Chapter 8.9.4.2, "Measuring Noise Density \(Noise Meas Marker\)"](#), on page 482.

Remote command:

`CALCulate<n>:MARKer<m>:FUNCTION:NOISe[:STATe]` on page 819

`CALCulate<n>:MARKer<m>:FUNCTION:NOISe:RESult?` on page 818

### Switching All Noise Measurement Off

Deactivates noise measurement for all markers.

Remote command:

`CALCulate<n>:MARKer<m>:FUNCTION:NOISe[:STATe]` on page 819

#### 8.9.4.3 Phase Noise Measurement Marker

**Access:** "Overview" > "Analysis" > "Marker Functions" > "Phase Noise" > "Phase Noise Config"

Or: [MKR] > "Select Marker Function" > "Phase Noise" > "Phase Noise Config"

For each of the 16 markers phase noise measurement can be activated.

Phase noise is unintentional modulation of a carrier; it creates frequencies next to the carrier frequency. A phase noise measurement consists of noise density measurements at defined offsets from the carrier; the results are given in relation to the carrier level (dBc). The phase noise marker function measures the noise power at the delta markers referred to 1 Hz bandwidth. Marker 1 is used as the reference for the phase noise measurement. By default, the current frequency and level of marker 1 are used as the fixed reference marker. However, a peak search can be started to use the current signal peak as the reference point, or a reference point can be defined manually.

Since the reference point is fixed, the reference level or the center frequency can be set so that the carrier is outside the displayed frequency range after phase noise measurement is started. Or a notch filter can be switched on to suppress the carrier.

Alternatively, the reference point can be determined automatically by a peak search after each sweep. This function can be used to track a drifting source during a phase noise measurement. The delta marker 2, which shows the phase noise measurement result, keeps the delta frequency value. Therefore the phase noise measurement leads to reliable results in a certain offset although the source is drifting. Only if the marker 2 reaches the border of the span, the delta marker value is adjusted to be within the span. In these cases, select a larger span.

The result of the phase noise measurement is the difference in level between the reference point and the noise power density. It is indicated as the function result of the phase noise marker in the marker table.

The sample detector is automatically used and the video bandwidth set to 0.1 times the resolution bandwidth (RBW). The two settings are taken into account in the correction values used for the noise power measurement. To obtain stable results, two pixels on the right and the left of the delta marker position are taken for the measurement.

The procedure for determining the noise power is identical to the method used for the noise power measurement (see [Chapter 8.9.4.2, "Measuring Noise Density \(Noise Meas Marker\)"](#), on page 482).

The individual marker settings correspond to those defined in the "Marker" dialog box. Any settings to the marker state or type changed in the "Marker Function" dialog box are also changed in the "Marker" dialog box and vice versa.

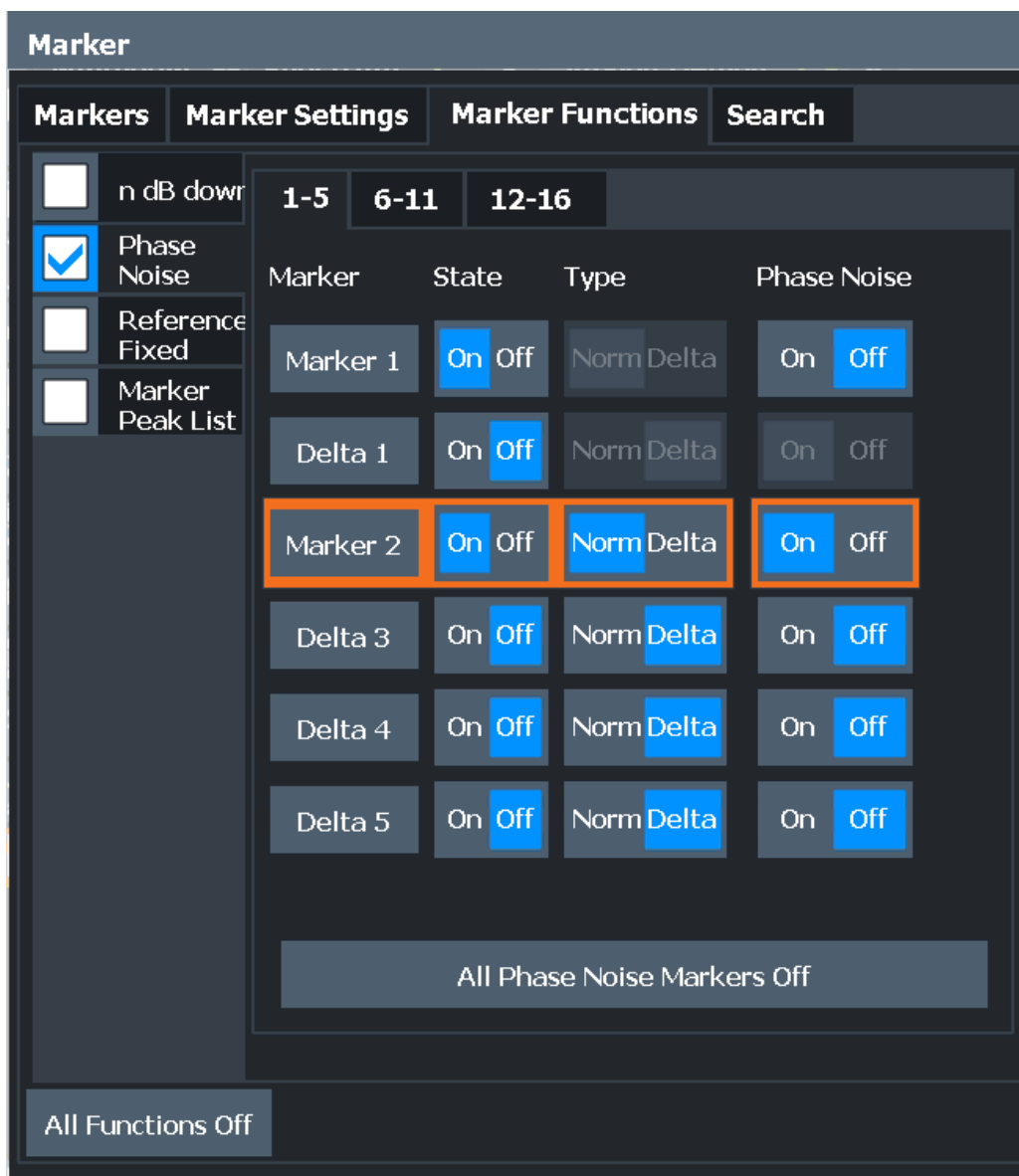

**Remote commands:**

[CALCulate<n>:MARKer<m>:FUNCTION:PNOise\[:STATe\]](#) on page 822

[CALCulate<n>:MARKer<m>:FUNCTION:PNOise:RESult?](#) on page 821

[Phase Noise Measurement State](#) ..... 486

[Defining Reference Point](#) ..... 487

[Switching All Phase Noise Measurements Off](#) ..... 487

**Phase Noise Measurement State**

Activates or deactivates phase noise measurement for the reference point in the diagram.

This function is only available for delta markers.

If activated, the delta markers display the phase noise measured at defined offsets from the reference position.

Remote command:

`CALCulate<n>:DELTAmarker<m>:FUNCTION:PNOise[:STATe]` on page 821

`CALCulate<n>:DELTAmarker<m>:FUNCTION:PNOise:RESult?` on page 820

### Defining Reference Point

Instead of using marker 1 as the reference marker, a fixed reference marker can be defined for phase noise measurement.

The "Level" and "Frequency" or "Time" settings define the position and value of the reference point.

Alternatively, a **Peak Search** can be performed to set the maximum value of the selected trace as the reference point.

If "Automatic Peak Search" is activated, a peak search is started automatically after each sweep and the result is used as the reference point.

Remote command:

`CALCulate<n>:DELTAmarker<m>:FUNCTION:FIXed:RPoint:Y` on page 813

`CALCulate<n>:DELTAmarker<m>:FUNCTION:FIXed:RPoint:X` on page 813

`CALCulate<n>:DELTAmarker<m>:FUNCTION:FIXed:RPoint:MAXimum[:PEAK]` on page 812

`CALCulate<n>:DELTAmarker<m>:FUNCTION:PNOise:AUTO` on page 820

### Switching All Phase Noise Measurements Off

Deactivates phase noise measurement for all markers.

Remote command:

`CALCulate<n>:DELTAmarker<m>:FUNCTION:PNOise[:STATe]` on page 821

#### 8.9.4.4 Measuring Characteristic Bandwidths (n dB Down Marker)

**Access:** "Overview" > "Analysis" > "Marker Functions" > "n dB down" > "n dB Down Config"

**Or:** [MKR] > "Select Marker Function" > "n dB down" > "n dB Down Config"

When characterizing the shape of a signal, the bandwidth at a specified offset from its peak level is often of interest. The offset is specified as a relative decrease in amplitude of n dB. To measure this bandwidth, you could use several markers and delta markers and determine the bandwidth manually. However, using the n dB down marker function makes the task very simple and quick.

The n dB down marker function uses the current value of marker 1 as the reference point. It activates two temporary markers T1 and T2 located on the signal, whose level is n dB below the level of the reference point. Marker T1 is placed to the left and marker T2 to the right of the reference marker. The default setting for n is 3 dB, but it can be changed.

If a positive offset is entered, the markers T1 and T2 are placed below the active reference point. If a negative value is entered (for example for notch filter measurements), the markers T1 and T2 are placed above the active reference point.

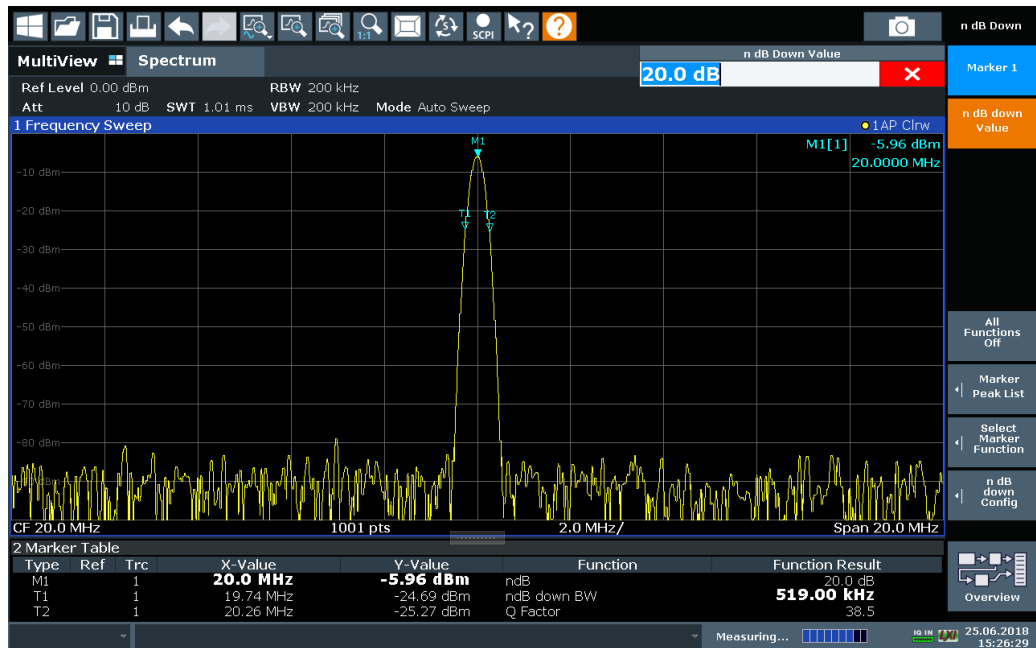

Figure 8-47: n dB down marker function

The following marker function results are displayed:

Table 8-24: n dB down marker function results

| Label              | Description                                                                         |
|--------------------|-------------------------------------------------------------------------------------|
| M1                 | Current position and level of marker 1                                              |
| ndB                | Offset value (n dB down)                                                            |
| ndB down Bw / PWid | Determined bandwidth or pulse width (zero span) at the offset                       |
| Q-factor           | Quality factor of the determined bandwidth (characteristic of damping or resonance) |
| T1, T2             | Current position and level of the temporary markers                                 |

If the required position for the temporary markers cannot be determined uniquely, for example due to noise, dashes are displayed as a result.

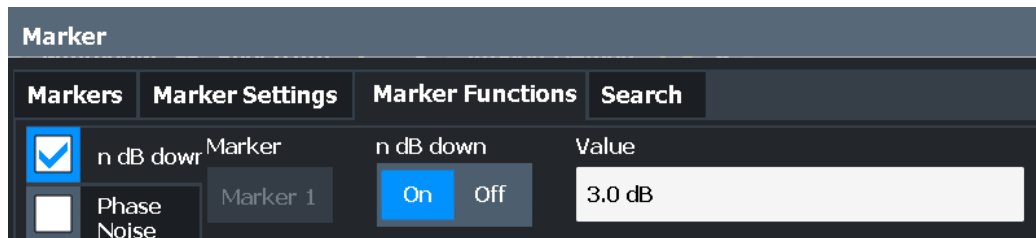

Remote commands:

CALCulate<n>:MARKer<m>:FUNCTION:NDBDown:STATE on page 828



[CALCulate<n>:MARKer<m>:FUNction:NDBDown:RESult?](#) on page 828

|                                              |     |
|----------------------------------------------|-----|
| <a href="#">n dB down Marker State</a> ..... | 489 |
| <a href="#">n dB down Value</a> .....        | 489 |

#### **n dB down Marker State**

Activates or deactivates the special n dB down marker function.

Remote command:

[CALCulate<n>:MARKer<m>:FUNction:NDBDown:STATe](#) on page 828

[CALCulate<n>:MARKer<m>:FUNction:NDBDown:RESult?](#) on page 828

#### **n dB down Value**

Defines the delta level from the reference marker 1 used to determine the bandwidth or time span.

Remote command:

[CALCulate<n>:MARKer<m>:FUNction:NDBDown:FREQuency?](#) on page 827

[CALCulate<n>:MARKer<m>:FUNction:NDBDown:TIME?](#) on page 829

### **8.9.4.5 Fixed Reference Marker**

**Access:** "Overview" > "Analysis" > "Marker Functions" > "Reference Fixed"

**Or:** [MKR] > "Select Marker Function" > "Reference Fixed"

Instead of using a reference marker that may vary its position depending on the measurement results, a fixed reference marker can be defined for trace analysis. Once positioned, the reference marker does not move during subsequent sweeps unless you explicitly move it manually.

When you select this marker function, a vertical and a horizontal red display line are displayed, marked as "FXD". A normal marker is activated and set to the peak value and a delta marker to the next peak. The fixed reference marker is set to the position of the normal marker at the peak value. The delta marker refers to the fixed reference marker.

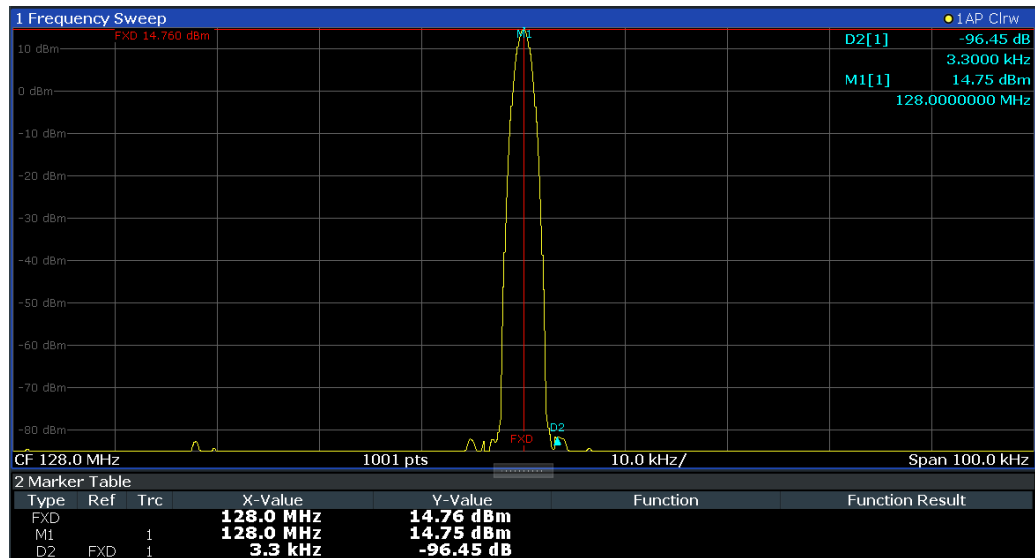

You can move the position of the fixed reference marker graphically by dragging the display lines, or numerically by entering values for the marker position and level.

#### Remote commands:

"Example: Using a Fixed Reference Marker" on page 837

CALCulate<n>:DELTaMarker<m>:FUNctIon:FIXed[:STATe] on page 814

CALCulate<n>:DELTaMarker<m>:FUNctIon:FIXed:RPOint:X on page 813

CALCulate<n>:DELTaMarker<m>:FUNctIon:FIXed:RPOint:Y on page 813

#### 8.9.4.6 Measuring the Power in a Channel (Band Power Marker)

**Access:** "Overview" > "Analysis" > "Marker Functions" > "Band Power" > "Band Power Config"

**or:** [MKR] > "Select Marker Function" > "Band Power"

To determine the noise power in a transmission channel, you could use a noise marker and multiply the result with the channel bandwidth. However, the results would only be accurate for flat noise.

Band power markers allow you to measure the integrated power for a defined span (band) around a marker (similar to ACP measurements). By default, 5 % of the current span is used. The span is indicated by limit lines in the diagram. The results can be displayed either as a power (dBm) or density (dBm/Hz) value and are indicated in the marker table for each band power marker.



**Relative band power markers**

The results for band power markers which are defined as *delta* markers and thus have a reference value can also be calculated as reference power values (in dB).

In this case, the result of the band power deltamarker is the difference between the absolute power in the band around the delta marker and the absolute power for the reference marker. The powers are subtracted logarithmically, so the result is a dB value.

$$[Relative\ band\ power\ (Delta2)\ in\ dB] = [absolute\ band\ power\ (Delta2)\ in\ dBm] - [absolute\ (band)\ power\ of\ reference\ marker\ in\ dBm]$$

The measured power for the reference marker may be an absolute power at a single point (if the reference marker is not a band power marker), or the power in a band (if the reference marker is a band power marker itself).

If the reference marker for the band power marker is also a delta marker, the absolute power level for the reference marker is used for calculation.



Band power markers are only available for standard frequency measurements (not zero span) in the Spectrum application.

For the I/Q Analyzer application, band power markers are only available for Spectrum displays.

The entire band must lie within the display. If it is moved out of the display, the result cannot be calculated (indicated by "- -" as the "Function Result" ). However, the width of the band is maintained so that the band power can be calculated again when it returns to the display.

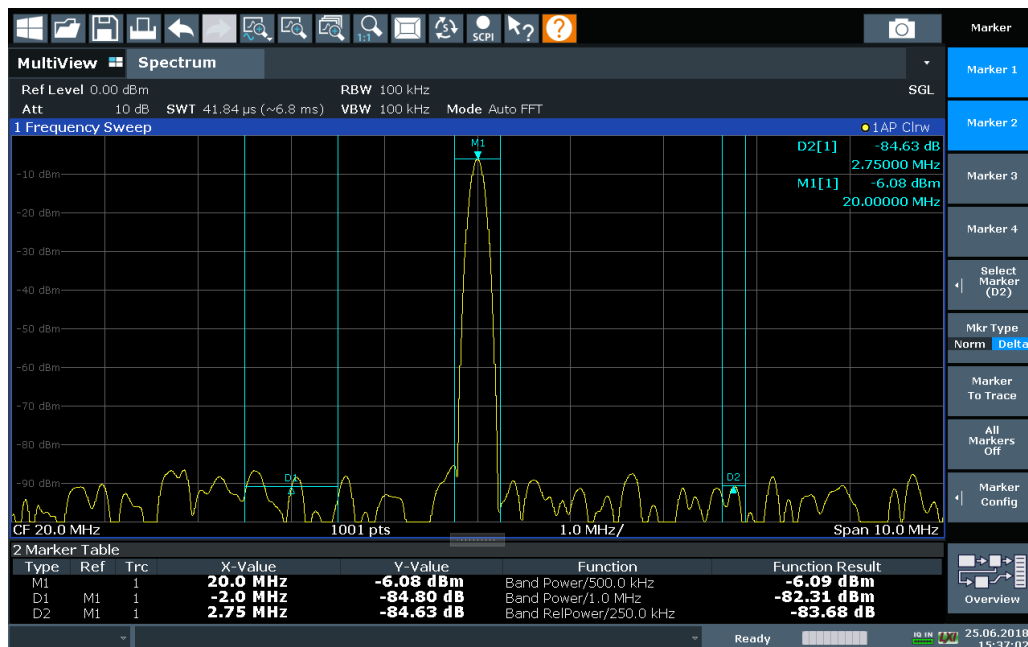

All markers can be defined as band power markers, each with a different span. When a band power marker is activated, if no marker is active yet, marker 1 is activated. Otherwise, the currently active marker is used as a band power marker (all other marker functions for this marker are deactivated).

If the detector mode for the marker trace is set to "Auto" , the RMS detector is used. The individual marker settings correspond to those defined in the "Marker" dialog box (see Chapter 8.9.2.1, "Individual Marker Setup", on page 467). Any settings to the marker state or type changed in the "Marker Function" dialog box are also changed in the "Marker" dialog box and vice versa.

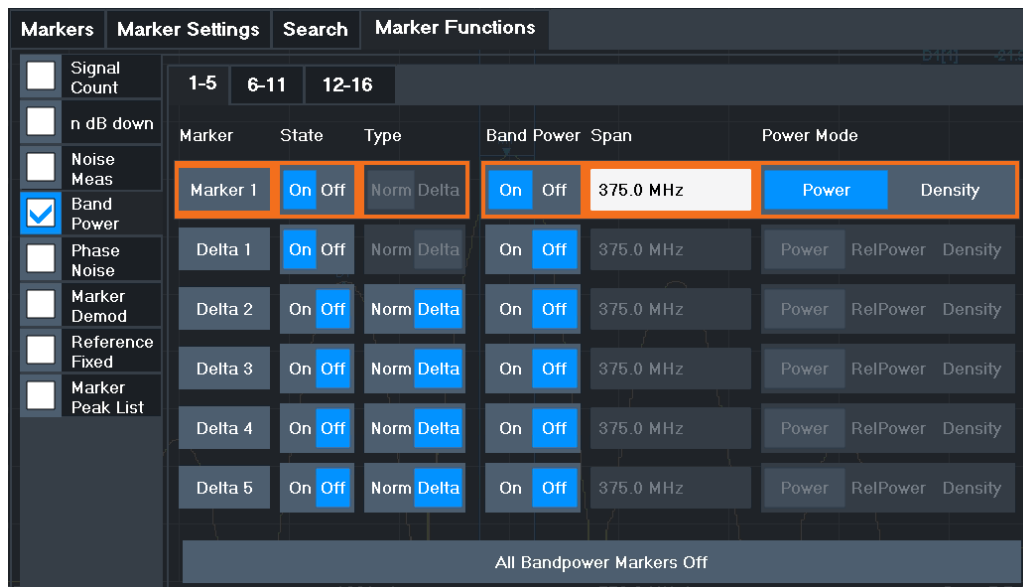

**Remote commands:**

"Example: Measuring the Power in a Channel Using Band Power Markers" on page 839

CALCulate<n>:MARKer<m>:FUNCTION:BPOWER[:STATe] on page 824

CALCulate<n>:MARKer<m>:FUNCTION:BPOWER:RESult? on page 823

Band Power Measurement State ..... 492

Span ..... 493

Power Mode ..... 493

Switching All Band Power Measurements Off ..... 493

**Band Power Measurement State**

Activates or deactivates band power measurement for the marker in the diagram. Band power markers are only available for standard frequency measurements (not zero span) in the Spectrum application.

If activated, the markers display the power or density measured in the band around the current marker position.

For details see Chapter 8.9.4.6, "Measuring the Power in a Channel (Band Power Marker)", on page 490.

Remote command:

CALCulate<n>:MARKer<m>:FUNCTION:BPOWER[:STATe] on page 824

CALCulate<n>:DELTAmarker<m>:FUNCTION:BPOWER[:STATe] on page 826

**Span**

Defines the span (band) around the marker for which the power is measured. The span is indicated by lines in the diagram.

Remote command:

[CALCulate<n>:MARKer<m>:FUNCTION:BPOWER:SPAN](#) on page 824

[CALCulate<n>:DELTAmarker<m>:FUNCTION:BPOWER:SPAN](#) on page 825

**Power Mode**

Defines the mode of the power measurement result.

For analog demodulation measurements, the power mode is not editable for AM, FM, or PM spectrum results. In this case, the marker function does not determine a power value, but rather the deviation within the specified span.

|                  |                                                                                                                                                                                                                                                                                                                                                                                                                                                                                                                                                                         |
|------------------|-------------------------------------------------------------------------------------------------------------------------------------------------------------------------------------------------------------------------------------------------------------------------------------------------------------------------------------------------------------------------------------------------------------------------------------------------------------------------------------------------------------------------------------------------------------------------|
| "Power"          | The result is an absolute power level.<br>The power unit depends on the <a href="#">Unit</a> setting.                                                                                                                                                                                                                                                                                                                                                                                                                                                                   |
| "Relative Power" | This setting is only available for a delta band power marker.<br>The result is the difference between the absolute power in the band around the delta marker and the absolute power for the reference marker (see " <a href="#">Reference Marker</a> " on page 397). The powers are subtracted logarithmically, so the result is a dB value.<br><i>[Relative band power (Delta2) in dB] = [absolute band power (Delta2) in dBm] - [absolute (band) power of reference marker in dBm]</i><br>For details see " <a href="#">Relative band power markers</a> " on page 491 |
| "Density"        | The result is a power level in relation to the bandwidth, displayed in dBm/Hz.                                                                                                                                                                                                                                                                                                                                                                                                                                                                                          |

Remote command:

[CALCulate<n>:MARKer<m>:FUNCTION:BPOWER:MODE](#) on page 823

[CALCulate<n>:DELTAmarker<m>:FUNCTION:BPOWER:MODE](#) on page 824

**Switching All Band Power Measurements Off**

Deactivates band power measurement for all markers.

Remote command:

[CALCulate<n>:MARKer<m>:FUNCTION:BPOWER\[:STATe\]](#) on page 824

[CALCulate<n>:DELTAmarker<m>:FUNCTION:BPOWER\[:STATe\]](#) on page 826

**8.9.4.7 Demodulating Marker Values and Providing Audio Output (Marker Demodulation)**

**Access:** "Overview" > "Analysis" > "Marker Functions" > "Select Marker Function" > "Marker Demodulation" > "Marker Demod Config"

**Or:** [MKR] > "Select Marker Function" > "Marker Demodulation" > "Marker Demod Config"

The R&S FPL1000 provides demodulators for AM, FM and PM signals. The demodulation marker function sends the demodulated data at the current marker frequency to the audio output. Thus, a displayed signal can be identified acoustically with the help of the internal loudspeaker or with headphones.

This function requires the optional additional interfaces (R&S FPL1000-B5).



This function is not available for Spectrum Emission Mask measurements or measurements on I/Q-based data.

The sweep stops at the frequency determined by marker 1 for the selected time and the RF signal is demodulated in a bandwidth that corresponds to the RBW. Alternatively, demodulation can be activated continuously, i.e. audio output occurs regardless of the marker position and the marker stop time. For measurements in the time domain (zero span), demodulation is always continuous.

Optionally, a minimum level ( "Squelch Level" ) can be defined so that the signal is only demodulated when it exceeds the set level. This is useful during continuous demodulation to avoid listening to noise.

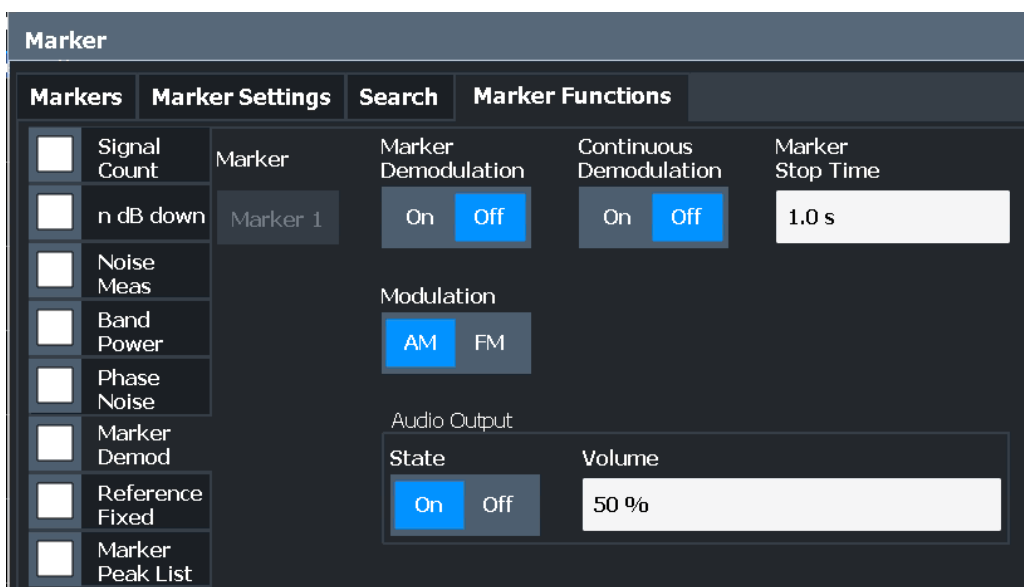

**Remote commands:**

"Examples: Demodulating Marker Values and Providing Audio Output" on page 841

Marker Demodulation State ..... 494  
 Continuous Demodulation ..... 495  
 Marker Stop Time ..... 495  
 Modulation ..... 495  
 Loudspeaker..... 495  
 Audio Output Volume..... 495

**Marker Demodulation State**

Activates or deactivates the demodulation output.

Remote command:

CALCulate<n>:MARKer<m>:FUNCTion:DEModulation[:STATe] on page 833

### Continuous Demodulation

If activated, the signal is demodulated continuously (not only at the marker position) and sent to the audio output. This allows you to monitor the frequency range acoustically (assuming the sweep time is long enough).

For zero span measurements, demodulation is always active continuously.

Remote command:

`CALCulate<n>:MARKer<m>:FUNction:DEModulation:CONTinuous`  
on page 832

### Marker Stop Time

Defines how long the sweep is stopped at the marker position to output the demodulated signal.

For zero span measurements, demodulation is always active continuously, regardless of the marker stop time.

Remote command:

`CALCulate<n>:MARKer<m>:FUNction:DEModulation:HOLDoff` on page 832

### Modulation

Defines the demodulation mode for output (AM/FM). The default setting is AM.

Remote command:

`CALCulate<n>:MARKer<m>:FUNction:DEModulation:SElect` on page 833

### Loudspeaker

If enabled, the demodulated audio signal is output to the IF/VIDEO connector (on the rear panel of the R&S FPL1000).

This connector is only available if the R&S FPL1-B5 option is installed.

Note that output to the [Phones] connector on the front panel is always possible, regardless of the "Loudspeaker" state.

Remote command:

`SYSTem:SPEaker[:STATe]` on page 755

### Audio Output Volume

Sets the volume of the built-in loudspeaker for demodulated signals. This setting is used for all applications.

The setting is available in the time domain in Spectrum mode and in Analog Demodulation mode.

This connector is only available if the R&S FPL1-B5 option is installed.

Remote command:

`SYSTem:SPEaker:VOLume` on page 755

#### 8.9.4.8 Marker Peak List

**Access:** "Overview" > "Analysis" > "Marker Functions" > "Marker Peak List"

**Or:** [MKR] > "Select Marker Function" > "Marker Peak List"

A common measurement task is to determine peak values, i.e. maximum or minimum signal levels. The R&S FPL1000 provides various peak search functions and applications:

- Setting a marker to a peak value once (Peak Search)
- Searching for a peak value within a restricted search area (Search Limits)
- Creating a marker table with all or a defined number of peak values for one sweep (Marker Peak List)
- Updating the marker position to the current peak value automatically after each sweep (Auto Peak Search)

#### **Peak search limits**

The peak search can be restricted to a search area. The search area is defined by limit lines which are also indicated in the diagram. In addition, a minimum value (threshold) can be defined as a further search condition.

#### **When is a peak a peak? - Peak excursion**

During a peak search, for example when a marker peak table is displayed, noise values may be detected as a peak if the signal is very flat or does not contain many peaks. Therefore, you can define a relative threshold ( "Peak Excursion" ). The signal level must increase by the threshold value before falling again before a peak is detected. To avoid identifying noise peaks as maxima or minima, enter a peak excursion value that is higher than the difference between the highest and the lowest value measured for the displayed inherent noise.

#### **Effect of peak excursion settings (example)**

The following figure shows a trace to be analyzed.



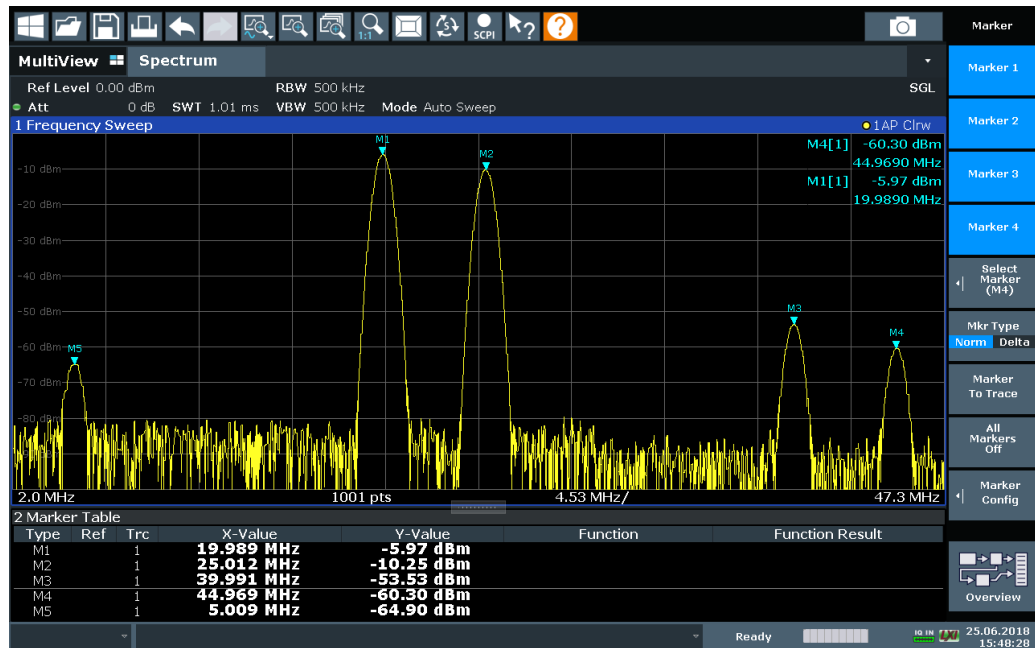

Figure 8-48: Trace example

The following table lists the peaks as indicated by the marker numbers in the diagram above, as well as the minimum decrease in amplitude to either side of the peak:

| Marker # | Min. amplitude decrease to either side of the signal |
|----------|------------------------------------------------------|
| 1        | 80 dB                                                |
| 2        | 80 dB                                                |
| 3        | 55 dB                                                |
| 4        | 39 dB                                                |
| 5        | 32 dB                                                |

In order to eliminate the smaller peaks M3, M4 and M5 in the example above, a peak excursion of at least 60 dB is required. In this case, the amplitude must rise at least 60 dB before falling again before a peak is detected.

### Marker peak list

The marker peak list determines the frequencies and levels of peaks in the spectrum. It is updated automatically after each sweep. How many peaks are displayed can be defined, as well as the sort order. In addition, the detected peaks can be indicated in the diagram. The peak list can also be exported to a file for analysis in an external application.

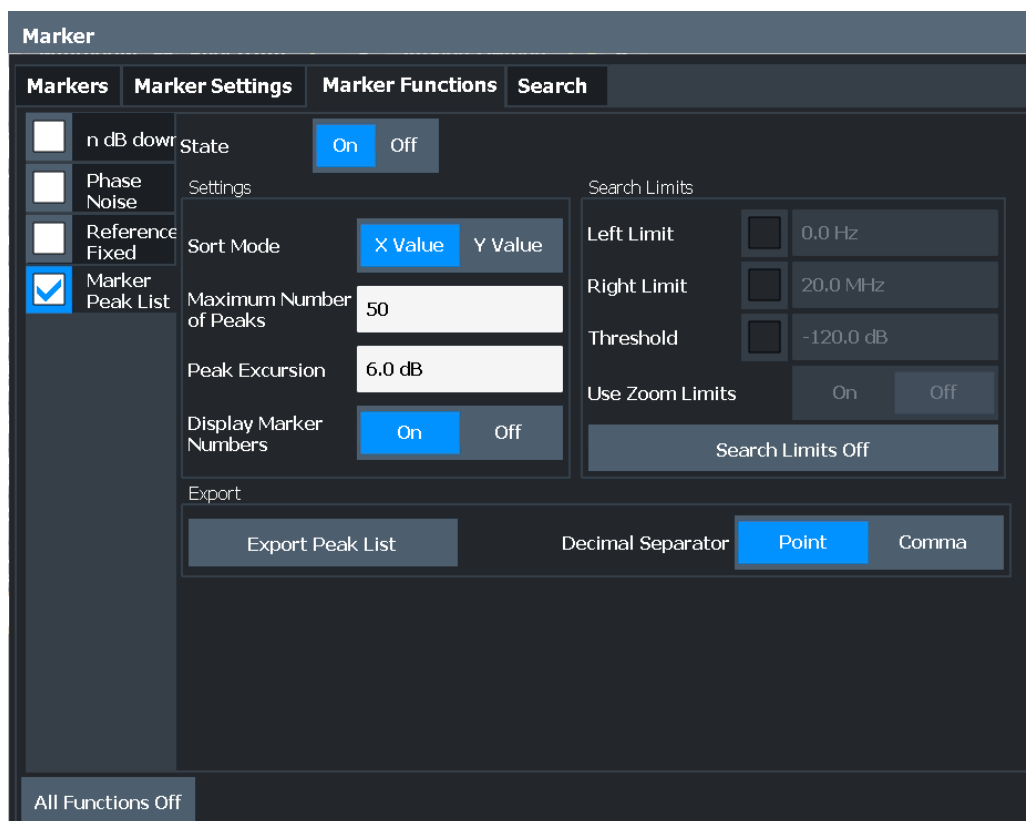

**Remote commands:**

"Example: Obtaining a Marker Peak List" on page 837

CALCulate<n>:MARKer<m>:FUNction:FPEaks:STATe on page 817

TRAC? LIST, see TRACe<n>[:DATA] on page 776

|                               |     |
|-------------------------------|-----|
| Peak List State .....         | 498 |
| Sort Mode .....               | 498 |
| Maximum Number of Peaks ..... | 499 |
| Peak Excursion .....          | 499 |
| Display Marker Numbers .....  | 499 |
| Export Peak List .....        | 499 |

**Peak List State**

Activates/deactivates the marker peak list. If activated, the peak list is displayed and the peaks are indicated in the trace display.

For each listed peak the frequency/time ( "X-value" ) and level ( "Y-Value" ) values are given.

Remote command:

CALCulate<n>:MARKer<m>:FUNction:FPEaks:STATe on page 817

**Sort Mode**

Defines whether the peak list is sorted according to the x-values or y-values. In either case the values are sorted in ascending order.

Remote command:

`CALCulate<n>:MARKer<m>:FUNCTION:FPEaks:SORT` on page 816

#### Maximum Number of Peaks

Defines the maximum number of peaks to be determined and displayed.

Remote command:

`CALCulate<n>:MARKer<m>:FUNCTION:FPEaks:LIST:SIZE` on page 816

#### Peak Excursion

Defines the minimum level value by which a signal must rise or fall so that it is identified as a maximum or a minimum by the search functions.

Entries from 0 dB to 80 dB are allowed; the resolution is 0.1 dB. The default setting for the peak excursion is 6 dB.

For analog demodulation, the unit and value range depend on the selected result display type.

For more information, see [Chapter 8.9.4.8, "Marker Peak List"](#), on page 495.

Remote command:

`CALCulate<n>:MARKer<m>:PEXCursion` on page 792

#### Display Marker Numbers

By default, the marker numbers are indicated in the diagram so you can find the peaks from the list. However, for large numbers of peaks the marker numbers may decrease readability; in this case, deactivate the marker number display.

Remote command:

`CALCulate<n>:MARKer<m>:FUNCTION:FPEaks:ANNotation:LABel[:STATe]`  
on page 815

#### Export Peak List

The peak list can be exported to an ASCII file (.DAT) for analysis in an external application.

Remote command:

`MMEMoRY:STORe<n>:PEAK` on page 887

`FORMat:DEXPort:DSEParator` on page 863

### 8.9.4.9 Deactivating All Marker Functions

**Access:** "Overview" > "Analysis" > "Marker Functions" > "All Functions Off"

**Or:** [MKR] > "All Functions Off"

All special marker functions can be deactivated in one step.

Remote command:

## 8.9.5 How to Work With Markers

The following step-by-step instructions demonstrate in detail how to work with markers.

- [How to Analyze a Signal Point in Detail](#)..... 500
- [How to Use a Fixed Reference Marker](#)..... 500

### 8.9.5.1 How to Analyze a Signal Point in Detail

When you need to analyze a characteristic point in the signal in more detail, the following procedure can be helpful:

1. Perform a peak search to determine the characteristic point roughly by pressing the [Peak Search] key.
2. If the required signal point is not the maximum, continue the peak search to one of the subsequent maxima or minima:
  - a) Press the [Mkr ->] key.
  - b) Select the "Next Peak" or "Next Min" key.
  - c) If necessary, change the search settings by selecting the "Search Config" softkey.
3. Center the display around the determined signal point by setting the marker value to the center frequency. Select the "Center = Mkr Freq" softkey.
4. Determine the precise frequency of the signal point:
  - a) Select the "Select Marker Function" softkey.
  - b) Select the "Signal Count" button.
  - c) Select the "Signal Count Resolution" softkey.
  - d) Select the resolution depending on how precise the result needs to be.

### 8.9.5.2 How to Use a Fixed Reference Marker

By default, delta markers refer to marker 1. However, they can also refer to a fixed reference marker.

#### How to Define and Move a Fixed Reference Marker

1. To display a fixed reference marker, do one of the following:
  - Press the [MKR FUNC] key, then select the "Reference Fixed" marker function.
  - In the "Marker" dialog box, in the "Reference Fixed" area of the "Marker Config" tab, set the "State" to "On" .

A vertical and a horizontal red display line are displayed, marked as "FXD" . The normal marker 1 is activated and set to the peak value of the trace assigned to marker 1, and a delta marker to the next peak. The fixed reference marker is set to the position of marker 1 at the peak value.

2. To move the fixed reference marker, do one of the following:
  - Change the "Level" and "Frequency" of the reference point in the "Marker Config" tab of the "Marker" dialog box, . By default, the current peak value of trace 1 is set.
  - Set the fixed reference marker to the current peak value by selecting the "Peak Search" button in the "Marker Config" tab of the "Marker" dialog box.
  - Move the "FXD" display lines that define the position of the fixed reference marker by dragging them on the screen.

#### How to Assign a Fixed Reference Marker to Delta Markers

1. In the "Marker" dialog box, select the horizontal "Markers" tab.
2. For the active delta marker that is to refer to the fixed reference marker, select "FXD" from the "Reference Marker" list.

The delta marker indicates the offset of the current trace value at the marker position from the fixed reference value.

### 8.9.6 Measurement Example: Measuring Harmonics Using Marker Functions

This measurement example describes how to measure harmonics using the provided marker functions. Note that this task can be performed much simpler using the Harmonic Distortion measurement (see [Chapter 8.2.10, "Harmonic Distortion Measurement"](#), on page 366).

#### Signal generator settings (e.g. R&S SMW):

|            |         |
|------------|---------|
| Frequency: | 128 MHz |
| Level:     | +15 dBm |

#### Procedure:

1. Preset the R&S FPL1000.
2. Set the center frequency to *128 MHz*.
3. Set the span to *100 kHz*.
4. Select "Auto Level".

The R&S FPL1000 displays the reference signal with a span of 100 kHz and resolution bandwidth of 1 kHz.

5. Switch on the marker by pressing the [MKR] key.

The marker is positioned on the trace maximum.

6. Set the measured signal frequency and the measured level as reference values:
  - a) Press the [MKR FUNC] key
  - b) Press the "Reference Fixed" softkey.

The position of the marker becomes the reference point. The reference point level is indicated by a horizontal line, the reference point frequency with a vertical line. At the same time, the delta marker 2 is switched on.

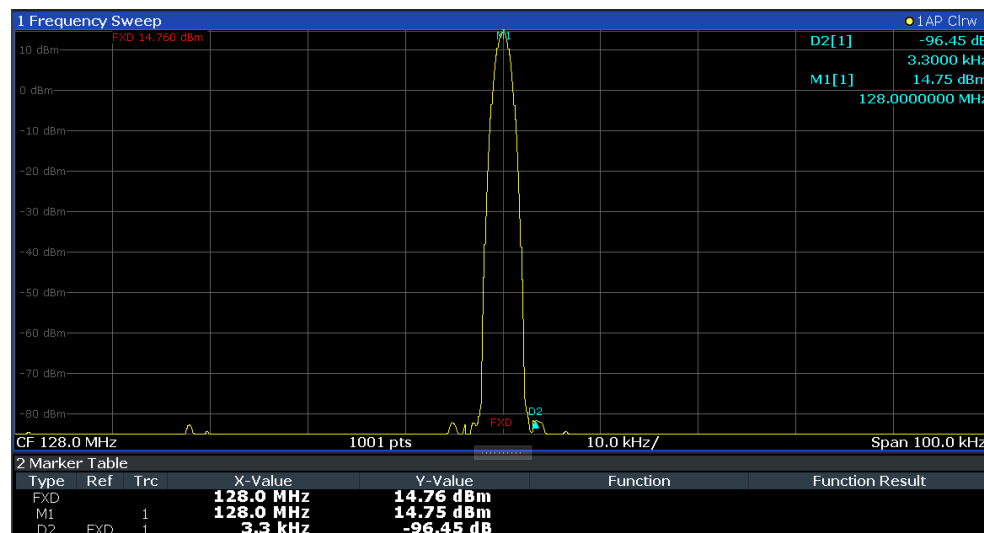

Figure 8-49: Fundamental wave and the frequency and level reference point

7. Make the step size for the center frequency correspond to the signal frequency: in the "Frequency" configuration dialog box, select "Center Frequency Stepsize" = "Marker" .

The step size for the center frequency is now equal to the marker frequency.

8. Move the center frequency to the 2<sup>nd</sup> harmonic of the signal by pressing the [UP] (↑) key.

The center frequency is set to the 2<sup>nd</sup> harmonic.

9. Select "Auto Level" to ensure the R&S FPL1000 measures the harmonics with a high sensitivity.
10. Place the delta marker on the 2<sup>nd</sup> harmonic: in the "Marker To" menu, select the "Peak" softkey.

The delta marker moves to the maximum of the 2<sup>nd</sup> harmonic. The displayed level result is relative to the reference point level (= fundamental wave level).

The other harmonics are measured by repeating steps [step 8](#) to [step 10](#), with the center frequency being incremented or decremented in steps of 128 MHz using the [UP] or [DOWN] keys.

## 8.10 Trace Configuration

A trace is a collection of measured data points. The trace settings determine how the measured data is analyzed and displayed on the screen.

- [Standard Traces](#).....503
- [Spectrograms](#).....515
- [Trace Math](#).....533

### 8.10.1 Standard Traces

#### 8.10.1.1 Basics on Setting up Traces

Some background knowledge on traces is provided here for a better understanding of the required configuration settings.

- [Mapping Samples to sweep Points with the Trace Detector](#).....503
- [Analyzing Several Traces - Trace Mode](#).....506
- [How Many Traces are Averaged - Sweep Count + Sweep Mode](#).....507
- [How Trace Data is Averaged - the Averaging Mode](#).....508
- [Trace Smoothing](#).....508

#### Mapping Samples to sweep Points with the Trace Detector

A trace displays the values measured at the sweep points. The number of samples taken during a sweep can be much larger than the number of sweep points that are displayed in the measurement trace.

#### Example:

Assume the following measurement parameters:

- Sample rate: 32 MSamples / s
- sweep points: 1000
- sweep time: 100 ms
- Span: 5 GHz

During a single sweep,  $3.2 \cdot 10^6$  samples are collected and distributed to 1000 sweep points, i.e. 3200 samples are collected per sweep point. For each sweep point, the measured data for a frequency span of 5 MHz ( $\text{span}/\langle \text{sweep points} \rangle$ ) is analyzed.

Note that if you increase the number of sweep points, the frequency span analyzed for each point in the trace decreases, making the result more stable.

See also [Chapter 8.6.1.8, "How Much Data is Measured: Sweep Points and Sweep Count"](#), on page 439.

Obviously, a data reduction must be performed to determine which of the samples are displayed for each sweep point. This is the trace detector's task.

The trace detector can analyze the measured data using various methods:



The detector activated for the specific trace is indicated in the corresponding trace information by an abbreviation.

**Table 8-25: Detector types**

| Detector      | Abbrev. | Description                                                                                                                                                                                                                                                                                                                                                                                                                                                                                                                                                                                                                                                                                                                                                                                      |
|---------------|---------|--------------------------------------------------------------------------------------------------------------------------------------------------------------------------------------------------------------------------------------------------------------------------------------------------------------------------------------------------------------------------------------------------------------------------------------------------------------------------------------------------------------------------------------------------------------------------------------------------------------------------------------------------------------------------------------------------------------------------------------------------------------------------------------------------|
| Positive Peak | Pk      | Determines the largest of all positive peak values of the levels measured at the individual frequencies which are displayed in one sample point                                                                                                                                                                                                                                                                                                                                                                                                                                                                                                                                                                                                                                                  |
| Negative Peak | Mi      | Determines the smallest of all negative peak values of the levels measured at the individual frequencies which are displayed in one sample point                                                                                                                                                                                                                                                                                                                                                                                                                                                                                                                                                                                                                                                 |
| Auto Peak     | Ap      | Combines the peak detectors; determines the maximum and the minimum value of the levels measured at the individual frequencies which are displayed in one sample point<br>(not available for SEM)                                                                                                                                                                                                                                                                                                                                                                                                                                                                                                                                                                                                |
| RMS           | Rm      | Calculates the root mean square of all samples contained in a sweep point.<br>To do so, R&S FPL1000 uses the linear voltage after envelope detection. The sampled linear values are squared, summed and the sum is divided by the number of samples (= root mean square). For logarithmic display, the logarithm is formed from the square sum. For linear display, the root mean square value is displayed. Each sweep point thus corresponds to the power of the measured values summed up in the sweep point.<br><br>The RMS detector supplies the power of the signal irrespective of the waveform (CW carrier, modulated carrier, white noise or impulsive signal). Correction factors as needed for other detectors to measure the power of the different signal classes are not required. |
| Average       | Av      | Calculates the linear average of all samples contained in a sweep point.<br>To this effect, R&S FPL1000 uses the linear voltage after envelope detection. The sampled linear values are summed up and the sum is divided by the number of samples (= linear average value). For logarithmic display, the logarithm is formed from the average value. For linear display, the average value is displayed. Each sweep point thus corresponds to the average of the measured values summed up in the sweep point.<br><br>The average detector supplies the average value of the signal irrespective of the waveform (CW carrier, modulated carrier, white noise or impulsive signal).                                                                                                               |
| Sample        | Sa      | Selects the last measured value of the levels measured at the individual frequencies which are displayed in one sample point; all other measured values for the frequency range are ignored                                                                                                                                                                                                                                                                                                                                                                                                                                                                                                                                                                                                      |

The result obtained from the selected detector for a sweep point is displayed as the value at this frequency point in the trace.



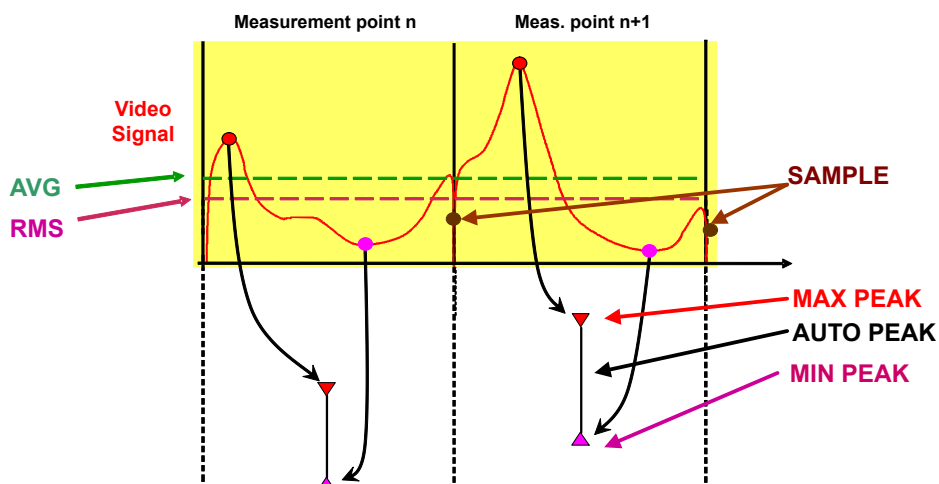

You can define the trace detector to be used for the individual traces manually, or the R&S FPL1000 can select the appropriate detector automatically.

The detectors of the R&S FPL1000 are implemented as pure digital devices. All detectors work in parallel in the background, which means that the measurement speed is independent of the detector combination used for different traces.



**RMS detector and VBW**

If the RMS detector is selected, the video bandwidth in the hardware is bypassed. Thus, duplicate trace averaging with small VBWs and RMS detector no longer occurs. However, the VBW is still considered when calculating the sweep time. This leads to a longer sweep time for small VBW values. Thus, you can reduce the VBW value to achieve more stable trace curves even when using an RMS detector. Normally, if the RMS detector is used, the sweep time should be increased to get more stable traces.

**Auto detector**

If the R&S FPL1000 is set to define the appropriate detector automatically, the detector is set depending on the selected trace mode:

| Trace mode  | Detector      |
|-------------|---------------|
| Clear Write | Auto Peak     |
| Max Hold    | Positive Peak |
| Min Hold    | Negative Peak |
| Average     | Sample Peak   |
| View        | –             |
| Blank       | –             |

### Analyzing Several Traces - Trace Mode

If several sweep are performed one after the other, or continuous sweep are performed, the trace mode determines how the data for subsequent traces is processed. After each sweep, the trace mode determines whether:

- The data is frozen (View)
- The data is hidden (Blank)
- The data is replaced by new values (Clear Write)
- The data is replaced selectively (Max Hold, Min Hold, Average)



Each time the trace mode is changed, the selected trace memory is cleared. The trace mode also determines the detector type if the detector is set automatically, see "[Mapping Samples to sweep Points with the Trace Detector](#)" on page 503.

The R&S FPL1000 supports the following trace modes:

**Table 8-26: Overview of available trace modes**

| Trace Mode  | Description                                                                                                                                                                                                                                                                                                                                                                                                                                                                                |
|-------------|--------------------------------------------------------------------------------------------------------------------------------------------------------------------------------------------------------------------------------------------------------------------------------------------------------------------------------------------------------------------------------------------------------------------------------------------------------------------------------------------|
| Blank       | Hides the selected trace.                                                                                                                                                                                                                                                                                                                                                                                                                                                                  |
| Clear Write | Overwrite mode: the trace is overwritten by each sweep. This is the default setting. All available detectors can be selected.                                                                                                                                                                                                                                                                                                                                                              |
| Max Hold    | The maximum value is determined over several measurements and displayed. The R&S FPL1000 saves the sweep result in the trace memory only if the new value is greater than the previous one.<br><br>This mode is especially useful with modulated or pulsed signals. The signal spectrum is filled up upon each sweep until all signal components are detected in a kind of envelope.<br><br>This mode is not available for statistics measurements.                                        |
| Min Hold    | The minimum value is determined from several measurements and displayed. The R&S FPL1000 saves the sweep result in the trace memory only if the new value is lower than the previous one.<br><br>This mode is useful for example for making an unmodulated carrier in a composite signal visible. Noise, interference signals or modulated signals are suppressed, whereas a CW signal is recognized by its constant level.<br><br>This mode is not available for statistics measurements. |
| Average     | The average is formed over several measurements and displayed.<br><br>The <a href="#">Sweep/Average Count</a> determines the number of averaging procedures.<br><br>This mode is not available for statistics measurements.                                                                                                                                                                                                                                                                |
| View        | The current contents of the trace memory are frozen and displayed.                                                                                                                                                                                                                                                                                                                                                                                                                         |



If a trace is frozen ("View" mode), the measurement settings, apart from scaling settings, can be changed without impact on the displayed trace. The fact that the displayed trace no longer matches the current measurement settings is indicated by a yellow asterisk \* on the tab label.

If you change any parameters that affect the scaling of the diagram axes, the R&S FPL1000 automatically adapts the trace data to the changed display range. This allows you to zoom into the diagram after the measurement to show details of the trace.

### How Many Traces are Averaged - Sweep Count + Sweep Mode

In "Average" trace mode, the sweep count and sweep mode determine how many traces are averaged. The more traces are averaged, the smoother the trace is likely to become.

The algorithm for averaging traces depends on the sweep mode and sweep count.

- **sweep count = 0** (default)
  - In "**Continuous**" sweep mode, a continuous average is calculated for 10 sweeps, according to the following formula:

$$Trace = \frac{9 * Trace_{old} + MeasValue}{10}$$

Figure 8-50: Equation 1

Due to the weighting between the current trace and the average trace, past values have practically no influence on the displayed trace after about ten sweeps. With this setting, signal noise is effectively reduced without need for restarting the averaging process after a change of the signal.

- In "**Single**" sweep mode, the current trace is averaged with the previously stored averaged trace. No averaging is carried out for the first sweep but the measured value is stored in the trace memory. The next time a sweep is performed, the trace average is calculated according to the following formula:

$$Trace = \frac{Trace_{old} + MeasValue}{2}$$

The averaged trace is then stored in the trace memory.

- **sweep count = 1**  
The currently measured trace is displayed and stored in the trace memory. No averaging is performed.
- **sweep count > 1**  
For both "**Single**" sweep mode and "**Continuous**" sweep mode, averaging takes place over the selected number of sweeps. In this case the displayed trace is determined during averaging according to the following formula:

$$Trace_n = \frac{1}{n} \cdot \left[ \sum_{i=1}^{n-1} (T_i) + MeasValue_n \right]$$

Figure 8-51: Equation 2

Where n is the number of the current sweep (n = 2 ... Sweep Count).

No averaging is carried out for the first sweep but the measured value is stored in the trace memory. With increasing n, the displayed trace is increasingly smoothed since there are more individual sweeps for averaging.

After the selected number of sweeps, the average trace is saved in the trace memory. Until this number of sweeps is reached, a preliminary average is displayed. When the averaging length defined by the "Sweep Count" is attained, averaging is continued in continuous sweep mode or for "Continue Single Sweep" according to the following formula:

$$Trace = \frac{(N - 1) * Trace_{old} + MeasValue}{N}$$

Where N is the sweep count

### How Trace Data is Averaged - the Averaging Mode

When the trace is averaged over several sweeps (Trace mode: "Average" ), different methods are available to determine the trace average.

With logarithmic averaging, the dB values of the display voltage are averaged or subtracted from each other with trace mathematical functions.

With linear averaging, the level values in dB are converted into linear voltages or powers before averaging. Voltage or power values are averaged or offset against each other and reconverted into level values.

For stationary signals, the two methods yield the same result.

Logarithmic averaging is recommended if sinewave signals are to be clearly visible against noise since with this type of averaging noise suppression is improved while the sinewave signals remain unchanged.

For noise or pseudo-noise signals, the positive peak amplitudes are decreased in logarithmic averaging due to the characteristic involved. The negative peak values are increased relative to the average value. If the distorted amplitude distribution is averaged, a value is obtained that is smaller than the actual average value. The difference is -2.5 dB.

This low average value is usually corrected in noise power measurements by a 2.5 dB factor. Therefore the R&S FPL1000 offers the selection of linear averaging. The trace data is linearized before averaging, then averaged and logarithmized again for display on the screen. The average value is always displayed correctly irrespective of the signal characteristic.

### Trace Smoothing

A Video Bandwidth Filter (VBW) is a hardware-based method of smoothing the trace (see also [Chapter 8.6.1.2, "Smoothing the Trace Using the Video Bandwidth"](#), on page 436). However, other sweep and bandwidth settings can be coupled to the VBW. For some signals, a VBW may not be freely selectable to obtain the required smoothing effect. Therefore, a software-based trace smoothing function is also available.

(Software-based) **smoothing** is a way to remove anomalies visually in the trace that can distort the results. The smoothing process is based on a moving average over the complete measurement range. The number of samples included in the averaging process (the *aperture* size) is variable and is a percentage of all samples that the trace consists of.

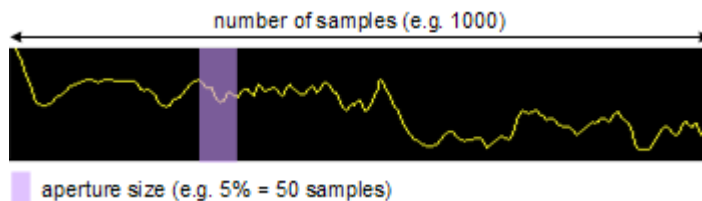

Figure 8-52: Sample size included in trace smoothing



### Effects of smoothing on post-processing functions

Note that in Spectrum mode, all functions performed after the sweep, such as limit checks, markers, or channel power measurements, are based on the smoothed trace data. Thus, the results differ from results based on the original trace.

You can turn trace smoothing on and off for all traces individually and compare, for example, the raw and the smooth trace.

Linear smoothing is based on the following algorithm:

$$y'(s) = \frac{1}{n} \left( \sum_{x=s-\frac{n-1}{2}}^{x=s+\frac{n-1}{2}} y(x) \right)$$

Equation 8-1: Linear trace smoothing

With:

s = sample number

x = sample offset from s

n = aperture size

#### 8.10.1.2 Trace Settings

**Access:** "Overview" > "Analysis" > "Traces"

Or: [TRACE] > "Trace Config"

You can configure the settings for up to 6 individual traces.

For settings on spectrograms, see [Chapter 8.10.2.2, "Spectrogram Settings"](#), on page 524.

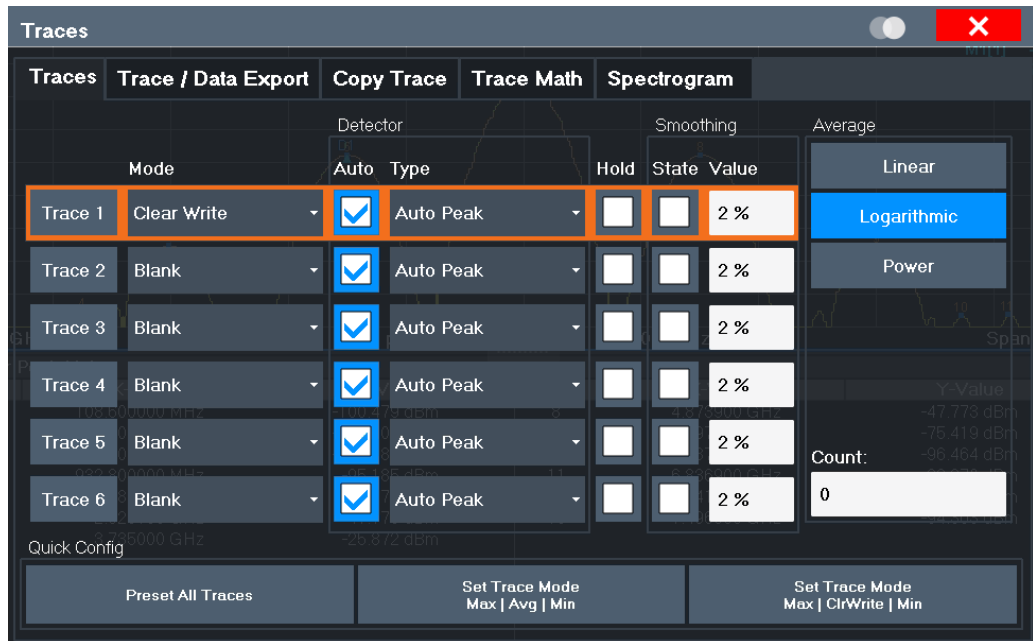

Trace 1 / Trace 2 / Trace 3 / Trace 4 / Trace 5 / Trace 6 .....510

Trace Mode ..... 510

Detector ..... 511

Hold ..... 511

Smoothing ..... 512

Average Mode ..... 512

Average Count ..... 512

Predefined Trace Settings - Quick Config ..... 513

Trace 1 / Trace 2 / Trace 3 / Trace 4 (Softkeys).....513

Copy Trace ..... 513

**Trace 1 / Trace 2 / Trace 3 / Trace 4 / Trace 5 / Trace 6**

Selects the corresponding trace for configuration. The currently selected trace is highlighted.

For details see [Chapter 8.10.1.3, "How to Configure a Standard Trace"](#), on page 514.

Remote command:

Selected via numeric suffix of:TRACe<1 . . . 6> commands

DISPlay[:WINDow<n>] [:SUBWindow<w>]:TRACe<t>[:STATe] on page 762

**Trace Mode**

Defines the update mode for subsequent traces.

For details, see ["Analyzing Several Traces - Trace Mode"](#) on page 506.

"Clear/ Write" Overwrite mode (default): the trace is overwritten by each sweep. The "Detector" is automatically set to "Auto Peak" .

|            |                                                                                                                                                                                                                                                                                                            |
|------------|------------------------------------------------------------------------------------------------------------------------------------------------------------------------------------------------------------------------------------------------------------------------------------------------------------|
| "Max Hold" | The maximum value is determined over several sweeps and displayed. The R&S FPL1000 saves each trace point in the trace memory only if the new value is greater than the previous one. The "Detector" is automatically set to "PositivePeak" . This mode is not available for statistics measurements.      |
| "Min Hold" | The minimum value is determined from several measurements and displayed. The R&S FPL1000 saves each trace point in the trace memory only if the new value is lower than the previous one. The "Detector" is automatically set to "Negative Peak" . This mode is not available for statistics measurements. |
| "Average"  | The average is formed over several sweeps. The <a href="#">Sweep/Average Count</a> determines the number of averaging procedures. The "Detector" is automatically set to "Sample" . This mode is not available for statistics measurements.                                                                |
| "View"     | The current contents of the trace memory are frozen and displayed.                                                                                                                                                                                                                                         |
| "Blank"    | Removes the selected trace from the display.                                                                                                                                                                                                                                                               |

Remote command:

`DISPlay[:WINDow<n>]:TRACe<t>:MODE` on page 760

### Detector

Defines the trace detector to be used for trace analysis.

For details see ["Mapping Samples to sweep Points with the Trace Detector"](#) on page 503.

"Auto" Selects the optimum detector for the selected trace and filter mode. This is the default setting.

"Type" Defines the selected detector type.

Remote command:

`[SENSe:] [WINDow<n>]:DETector<t>[:FUNction]` on page 764

`[SENSe:] [WINDow<n>]:DETector<t>[:FUNction]:AUTO` on page 765

### Hold

If activated, traces in "Min Hold" , "Max Hold" and "Average" mode are not reset after specific parameter changes have been made.

Normally, the measurement is started again after parameter changes, before the measurement results are analyzed (e.g. using a marker). In all cases that require a new measurement after parameter changes, the trace is reset automatically to avoid false results (e.g. with span changes). For applications that require no reset after parameter changes, the automatic reset can be switched off.

The default setting is off.

Remote command:

`DISPlay[:WINDow<n>][:SUBWindow<w>]:TRACe<t>:MODE:HCONTinuous` on page 761

**Smoothing**

If enabled, the trace is smoothed by the specified value (between 1 % and 50 %). The smoothing value is defined as a percentage of the display width. The larger the smoothing value, the greater the smoothing effect.

**Note:** Effects of smoothing on post-processing functions. Note that in Spectrum mode, all functions performed after the sweep, such as limit checks, markers, or channel power measurements, are based on the smoothed trace data. Thus, the results will differ from results based on the original trace.

For more information see ["Trace Smoothing"](#) on page 508.

Remote command:

`DISPlay[:WINDow<n>][:SUBWindow<w>]:TRACe<t>:SMOothing[:STATe]`  
on page 762

`DISPlay[:WINDow<n>][:SUBWindow<w>]:TRACe<t>:SMOothing:APERture`  
on page 762

**Average Mode**

Defines the mode with which the trace is averaged over several sweeps.

This setting is generally applicable if trace mode "Average" is selected. For FFT sweeps, the setting also affects the VBW (regardless of whether or not the trace is averaged).

(See also ["Video Bandwidth \(VBW\)"](#) on page 267).

How many sweeps are averaged is defined by the ["Sweep/Average Count"](#) on page 444.

For details see ["How Trace Data is Averaged - the Averaging Mode"](#) on page 508.

|               |                                                                                                                                                                                                                                                                                                                                                                                                     |
|---------------|-----------------------------------------------------------------------------------------------------------------------------------------------------------------------------------------------------------------------------------------------------------------------------------------------------------------------------------------------------------------------------------------------------|
| "Linear"      | The power level values are converted into linear units prior to averaging. After the averaging, the data is converted back into its original unit.                                                                                                                                                                                                                                                  |
| "Logarithmic" | For logarithmic scaling, the values are averaged in dBm. For linear scaling, the behavior is the same as with linear averaging.                                                                                                                                                                                                                                                                     |
| "Power"       | Activates linear power averaging.<br>The power level values are converted into unit Watt prior to averaging. After the averaging, the data is converted back into its original unit.<br>Use this mode to average power values in Volts or Amperes correctly. In particular, for small VBW values (smaller than the RBW), use power averaging mode for correct power measurements in FFT sweep mode. |

Remote command:

`[SENSe:] AVERage<n>:TYPE` on page 764

**Average Count**

Determines the number of averaging or maximum search procedures If the trace modes "Average", "Max Hold" or "Min Hold" are set.

In continuous sweep mode, if sweep count = 0 (default), averaging is performed over 10 sweeps. For sweep count =1, no averaging, Max Hold or Min Hold operations are performed.



This value is identical to the [Sweep/Average Count](#) setting in the "Sweep" settings.

Remote command:

[\[SENSe:\]AVERAge<n>:COUNT](#) on page 763

### Predefined Trace Settings - Quick Config

Commonly required trace settings have been predefined and can be applied very quickly by selecting the appropriate button.

| Function                               | Trace Settings |                                           |
|----------------------------------------|----------------|-------------------------------------------|
| Preset All Traces                      | Trace 1:       | Clear Write<br>Auto Detector (Auto Peak)  |
|                                        | Traces 2-6:    | Blank<br>Auto Detector                    |
| Set Trace Mode<br>Max   Avg   Min      | Trace 1:       | Max Hold<br>Auto Detector (Positive Peak) |
|                                        | Trace 2:       | Average<br>Auto Detector (Sample)         |
|                                        | Trace 3:       | Min Hold<br>Auto Detector (Negative Peak) |
|                                        | Traces 4-6:    | Blank<br>Auto Detector                    |
| Set Trace Mode<br>Max   ClrWrite   Min | Trace 1:       | Max Hold<br>Auto Detector (Positive Peak) |
|                                        | Trace 2:       | Clear Write<br>Auto Detector (Auto Peak)  |
|                                        | Trace 3:       | Min Hold<br>Auto Detector (Negative Peak) |
|                                        | Traces 4-6:    | Blank<br>Auto Detector                    |

### Trace 1 / Trace 2 / Trace 3 / Trace 4 (Softkeys)

Displays the "Traces" settings and focuses the "Mode" list for the selected trace.

For details see [Chapter 8.10.1.3, "How to Configure a Standard Trace"](#), on page 514.

Remote command:

[DISPlay\[:WINDow<n>\]\[:SUBWindow<w>\]:TRACe<t>\[:STATe\]](#) on page 762

### Copy Trace

**Access:** "Overview" > "Analysis" > "Traces" > "Copy Trace"

Or: [TRACE] > "Copy Trace"

Copies trace data to another trace.

The first group of buttons (labeled "Trace 1" to "Trace 6" ) selects the source trace. The second group of buttons (labeled "Copy to Trace 1" to "Copy to Trace 6" ) selects the destination.

Remote command:

TRACe<n>:COPY on page 765

### 8.10.1.3 How to Configure a Standard Trace

Step-by-step instructions on configuring the trace settings are provided here.

For details on individual functions and settings see [Chapter 8.10.1.2, "Trace Settings"](#), on page 509.

The remote commands required to perform these tasks are described in [Chapter 9.8.7, "Configuring the Trace Display and Retrieving Trace Data"](#), on page 759.

Trace settings are configured in the "Traces" dialog box.

To display the "Traces" dialog box, do one of the following:

- Press the [TRACE] key and then select the "Trace Config" softkey.
  - Select "Analysis" from the "Overview" , then select the "Traces" tab.
1. For each trace, select the "Trace Mode" and "Trace Detector" . Traces with the trace mode "Blank" are not displayed.
  2. To configure several traces to predefined display modes in one step, press the button for the required function:
    - "Preset All Traces"
    - "Set Trace Mode Max | Avg | Min"
    - "Set Trace Mode Max | ClrWrite | Min"
  3. For "Average" trace mode, define the number of sweeps to be averaged in the "Count:" field.
  4. If linear scaling is used, select the "Average Mode" : "Linear" .
  5. To improve the trace stability, increase the number of "Sweep Points" or the "Sweep Time" (in the "Sweep" settings).

All configured traces (not set to "Blank" ) are displayed after the next sweep.

#### How to Copy Traces

1. A trace copy function is provided in a separate tab of the "Traces" dialog box. To display this tab do one of the following:
  - Select the [TRACE] key and then the "Trace Copy" softkey.
  - Select "Analysis" from the "Overview" , then select the "Trace Copy" tab.
2. Select the "Source" trace to be copied.

3. Select the "Copy to Trace" button for the trace to which the settings are to be applied.

The settings from the source trace are applied to the destination trace. The newly configured trace (if not set to "Blank" ) is displayed after the next sweep.

## 8.10.2 Spectrograms

### 8.10.2.1 Working with Spectrograms

In addition to the standard "level versus frequency" or "level versus time" traces, the R&S FPL1000 also provides a spectrogram display of the measured data.

A spectrogram shows how the spectral density of a signal varies over time. The x-axis shows the frequency, the y-axis shows the time. A third dimension, the power level, is indicated by different colors. Thus you can see how the strength of the signal varies over time for different frequencies.



Three-dimensional spectrograms are also available and are described in "[Three-Dimensional Spectrograms](#)" on page 519. Most basic information described in the following sections applies similarly to both two- and three-dimensional spectrograms.

#### Example:

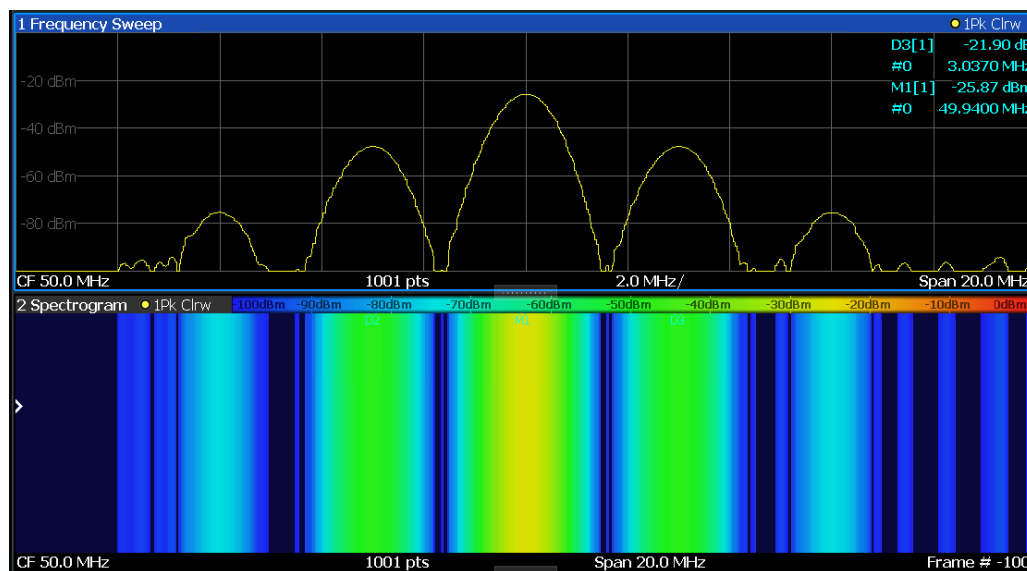

In this example, you see the spectrogram for the calibration signal of the R&S FPL1000, compared to the standard spectrum display. Since the signal does not change over time, the color of the frequency levels does not change over time, i.e. vertically. The legend above the spectrogram display describes the power levels the colors represent.

**Result display**

The spectrogram result can consist of the following elements:

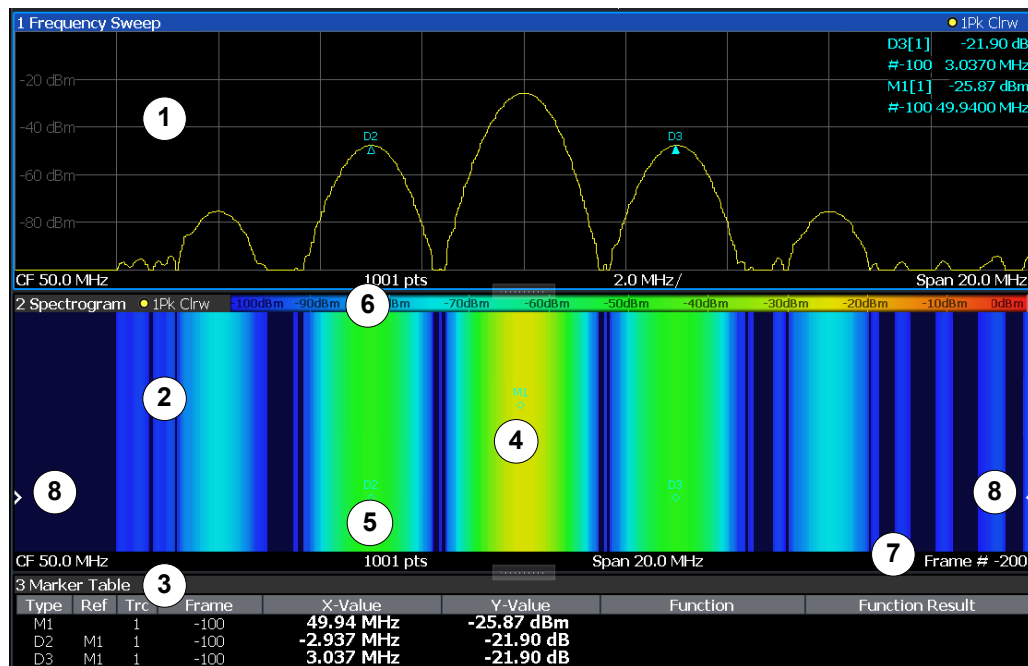

**Figure 8-53: Screen layout of the spectrogram result display**

- 1 = Spectrum result display
- 2 = Spectrogram result display
- 3 = Marker list
- 4 = Marker
- 5 = Delta marker
- 6 = Color map
- 7 = Timestamp / frame number
- 8 = Current frame indicator

For more information about spectrogram configuration, see [Chapter 8.10.2.2, "Spectrogram Settings"](#), on page 524.

**Remote commands:**

Activating and configuring spectrograms:

[Chapter 9.8.7.2, "Configuring Spectrograms"](#), on page 765

Storing results:

`MMEMory:STORe<n>:SPECTrogram` on page 887

- [Time Frames](#)..... 517
- [Markers in the Spectrogram](#).....518
- [Three-Dimensional Spectrograms](#)..... 519
- [Color Maps](#).....521

### Time Frames

The time information in the spectrogram is displayed vertically, along the y-axis. Each line (or trace) of the y-axis represents one or more captured sweep and is called a **time frame** or simply "frame". As with standard spectrum traces, several measured values are combined in one sweep point using the selected detector.

(See "[Mapping Samples to sweep Points with the Trace Detector](#)" on page 503).

Frames are sorted in chronological order, beginning with the most recently recorded frame at the top of the diagram (frame number 0). With the next sweep, the previous frame is moved further down in the diagram, until the maximum number of captured frames is reached. The display is updated continuously during the measurement, and the measured trace data is stored. Spectrogram displays are continued even after single measurements unless they are cleared manually.



In three-dimensional spectrograms, frames are displayed vertically. The most recently recorded frame (frame 0) is added at the front of the display (in the default position). For more information, see "[Three-Dimensional Spectrograms](#)" on page 519.

The maximum number of frames that you can capture is summarized in [Table 8-27](#).

**Table 8-27: Correlation between number of sweep points and number of frames stored in the history buffer**

| Sweep Points | Max. History Depth |
|--------------|--------------------|
| ≤1250        | 20000              |
| 2001         | 12488              |
| 4001         | 6247               |
| 8.001        | 3124               |
| 16.001       | 1562               |
| 32.001       | 781                |



The scaling of the time axis (y-axis) is not configurable. However, you can enlarge the spectrogram display by maximizing the window using the "Split/Maximize" key.



### Frame analysis - Frame count vs. sweep count

As described for standard spectrum sweeps, the sweep count defines how many sweeps are analyzed to create a single trace. Thus, for a trace in "Average" mode, for example, a sweep count of 10 means that 10 sweeps are averaged to create a single trace, or frame.

The frame count, on the other hand, determines how many frames are plotted during a single sweep measurement (as opposed to a continuous sweep). For a frame count of 2, for example, 2 frames will be plotted during each single sweep. For continuous

sweep mode, the frame count is irrelevant; one frame is plotted per sweep until the measurement is stopped.

If you combine the two settings, 20 sweeps will be performed for each single sweep measurement. The first 10 will be averaged to create the first frame, the next 10 will be averaged to create the second frame.

As you can see, increasing the sweep count increases the accuracy of the individual traces, while increasing the frame count increases the number of traces in the diagram.

Especially for "Average" or "Min Hold" and "Max Hold" trace modes, the number of sweeps that are analyzed to create a single trace has an effect on the accuracy of the results. Thus, you can also define whether the results from frames in previous traces are considered in the analysis for each new trace ("Continue Frame").

### Tracking absolute time - timestamps

Alternatively to the frame count, the absolute time (that is: a *timestamp*) at which a frame was captured can be displayed. While the measurement is running, the timestamp shows the system time. In single sweep mode or if the sweep is stopped, the timestamp shows the time and date at the end of the sweep. Thus, the individual frames can be identified by their timestamp or their frame count.

When active, the timestamp replaces the display of the frame number in the diagram footer (see [Figure 8-53](#)).

### Displaying individual frames

The spectrogram diagram contains all stored frames since it was last cleared. Arrows on the left and right border of the spectrogram indicate the currently selected frame. The spectrum diagram always displays the spectrum for the currently selected frame.

The current frame number is indicated in the diagram footer, or alternatively a timestamp, if activated. The current frame, displayed at the top of the diagram, is frame number 0. Older frames further down in the diagram are indicated by a negative index, e.g. "-10". You can display the spectrum diagram of a previous frame by changing the current frame number.

### Markers in the Spectrogram

Markers and delta markers are shaped like diamonds in the spectrogram. They are only displayed in the spectrogram if the marker position is inside the visible area of the spectrogram. If more than two markers are active, the marker values are displayed in a separate marker table.



Markers in three-dimensional spectrograms are slightly different and are described in "[Markers in three-dimensional spectrograms](#)" on page 521.

---

In the spectrum result display, the markers and their frequency and level values (1) are displayed as usual. Additionally, the frame number is displayed to indicate the position of the marker in time (2).

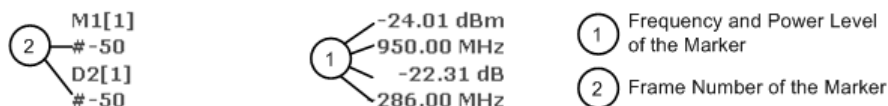

In the spectrogram result display, you can activate up to 16 markers or delta markers at the same time. Each marker can be assigned to a different frame. Therefore, in addition to the frequency you also define the frame number when activating a new marker. If no frame number is specified, the marker is positioned on the currently selected frame. All markers are visible that are positioned on a visible frame. Special search functions are provided for spectrogram markers.

In the spectrum result display, only the markers positioned on the currently selected frame are visible. In "Continuous Sweep" mode, this means that only markers positioned on frame 0 are visible. To view markers that are positioned on a frame other than frame 0 in the spectrum result display, you must stop the measurement and select the corresponding frame.

### Three-Dimensional Spectrograms

A common spectrogram shows the frequency on the x-axis, while the y-axis shows the time (in frames). The power level is indicated by different colors of the 2-dimensional points.

In the new 3-dimensional spectrogram, the power is indicated by a value in a third dimension, the z-axis. The color mapping is maintained for the point in the 3-dimensional result display.

This new display provides an even better overview of how the strength of the signal varies over time for different frequencies.

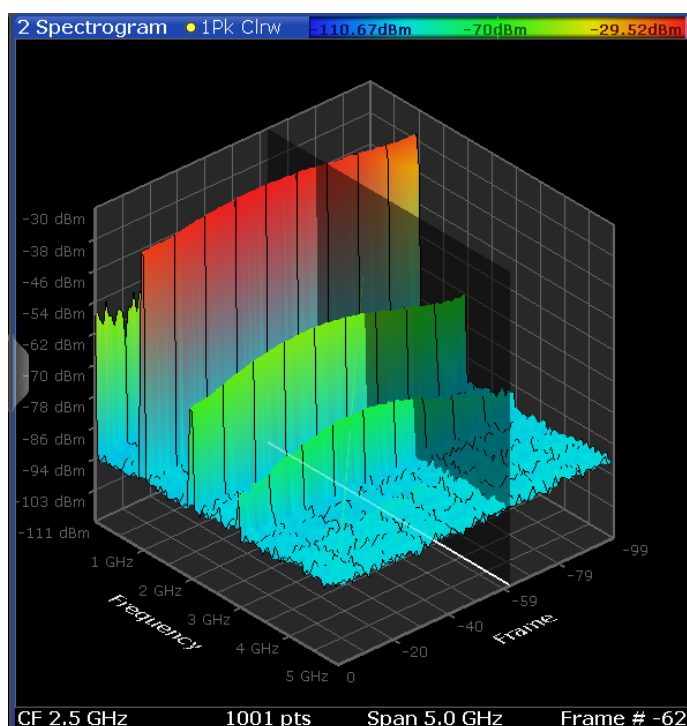

**Figure 8-54: Three-dimensional spectrogram**

The number of frames displayed on the time (y-)axis is user-definable, whereas for 2-dimensional spectrograms, the number of frames is determined automatically according to the size of the window. All other spectrogram settings are identical for 3-dimensional and 2-dimensional spectrograms.

When the measurement is stopped or completed, the currently selected frame is indicated by a gray vertical plane. (As opposed to the small white arrows at the borders of the 2-dimensional display.) The spectrum diagram always displays the spectrum for the currently selected frame.

By default, the most recently recorded frame (frame 0) is selected, and added at the front of the diagram.

### Rotating the spectrogram in three dimensions

Depending on which aspect of the spectrogram is currently of interest, you can rotate the display to have a closer look at the frequency, the time, or the power dimension. Simply drag your finger or the mouse pointer over the spectrogram in the direction you want to rotate it. You can rotate the display left or right, up and down. Note, however, that the degree of rotation is restricted in the upward direction to avoid confusing views. If you rotate the spectrogram such that you see the frequency-frame-plane directly from above, the display is identical to the 2-dimensional spectrogram.

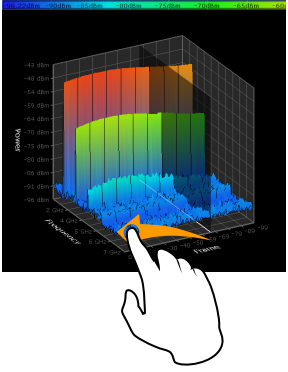
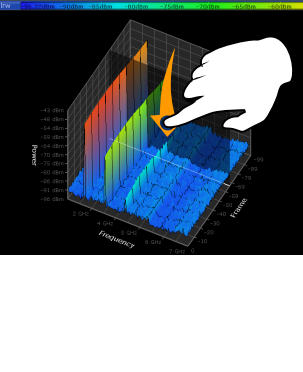
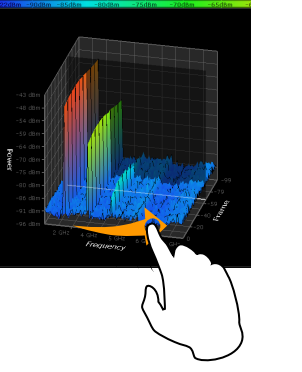

Table 8-28: Effect of rotating the spectrogram in three dimensions

|                                                                                   |                                                                                    |                                                                                     |
|-----------------------------------------------------------------------------------|------------------------------------------------------------------------------------|-------------------------------------------------------------------------------------|
|  |  |  |
| Rotation to the left > focus on frame                                             | Rotation down > focus on frequency and frame                                       | Rotation to the right > focus on frequency                                          |

### Markers in three-dimensional spectrograms

In three-dimensional spectrograms, the markers are indicated by the common arrows used in the spectrum display, for example. New markers are automatically placed on the current frame. You can move the markers to any position in all dimensions of the diagram. When you select a marker on the screen, three-dimensional cross-hairs indicate the position on all axes.

Sometimes, a marker can be hidden by other frames. If necessary, rotate the spectrogram or select a different frame as the current frame.

### Color Maps

Spectrograms assign power levels to different colors to visualize them. The legend above the spectrogram display describes the power levels the colors represent.

The color display is highly configurable to adapt the spectrograms to your needs. You can define:

- Which colors to use (Color scheme)
- Which value range to apply the color scheme to
- How the colors are distributed within the value range, i.e. where the focus of the visualization lies (shape of the color curve)

The individual colors are assigned to the power levels automatically by the R&S FPL1000.

### The Color Scheme

- **Hot**



Uses a color range from blue to red. Blue colors indicate low levels, red colors indicate high ones.

- **Cold**



Uses a color range from red to blue. Red colors indicate low levels, blue colors indicate high ones.

The "Cold" color scheme is the inverse "Hot" color scheme.

- **Radar**



Uses a color range from black over green to light turquoise with shades of green in between. Dark colors indicate low levels, light colors indicate high ones.

- **Grayscale**



Shows the results in shades of gray. Dark gray indicates low levels, light gray indicates high ones.

### The Value Range of the Color Map

If the measured values only cover a small area in the spectrogram, you can optimize the displayed value range so it becomes easier to distinguish between values that are close together. Display only parts of interest.

### The Shape and Focus of the Color Curve

The color mapping function assigns a specified color to a specified power level in the spectrogram display. By default, colors on the color map are distributed evenly. However, to visualize a certain area of the value range in greater detail than the rest, you can set the focus of the color mapping to that area. Changing the focus is performed by changing the shape of the color curve.

The color curve is a tool to shift the focus of the color distribution on the color map. By default, the color curve is linear. If you shift the curve to the left or right, the distribution becomes non-linear. The slope of the color curve increases or decreases. One end of the color palette then covers a large range of results, while the other end distributes several colors over a relatively small result range.

You can use this feature to put the focus on a particular region in the diagram and to be able to detect small variations of the signal.

**Example:**

In the color map based on the linear color curve, the range from -100 dBm to -60 dBm is covered by blue and a few shades of green only. The range from -60 dBm to -20 dBm is covered by red, yellow and a few shades of green.

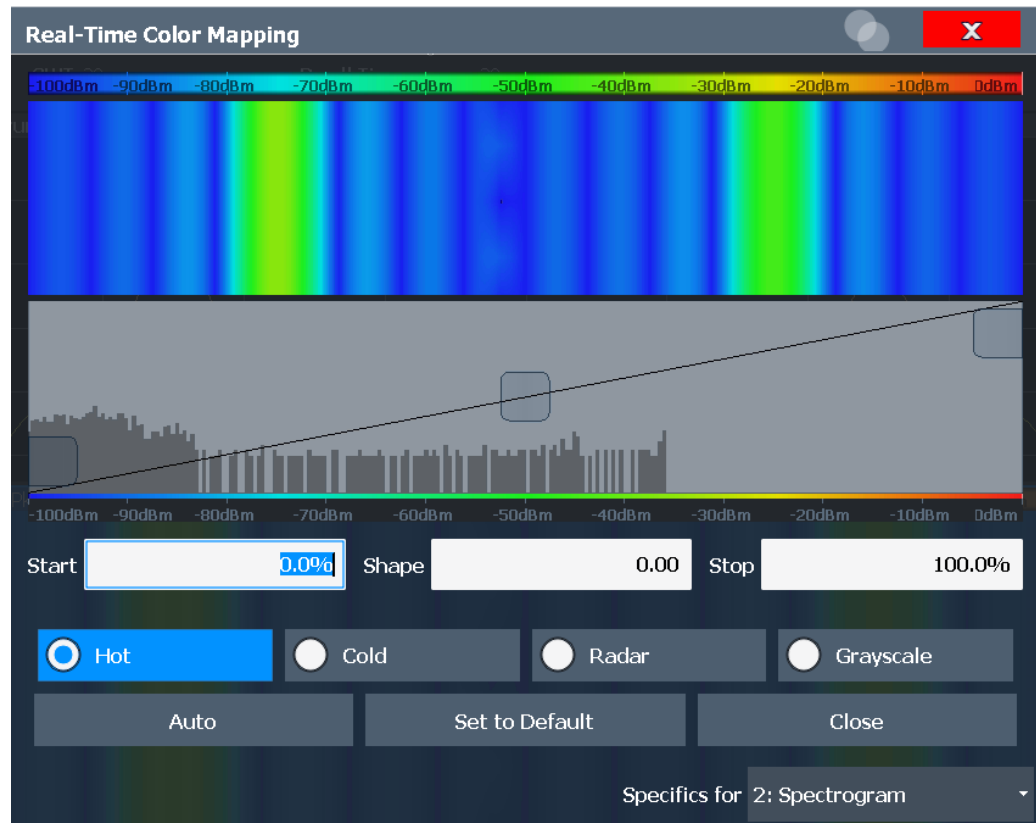

**Figure 8-55: Spectrogram with (default) linear color curve shape = 0**

The sample spectrogram is dominated by blue and green colors. After shifting the color curve to the left (negative value), more colors cover the range from -100 dBm to -60 dBm (blue, green and yellow). This range occurs more often in the example. The range from -60 dBm to -20 dBm, on the other hand, is dominated by various shades of red only.

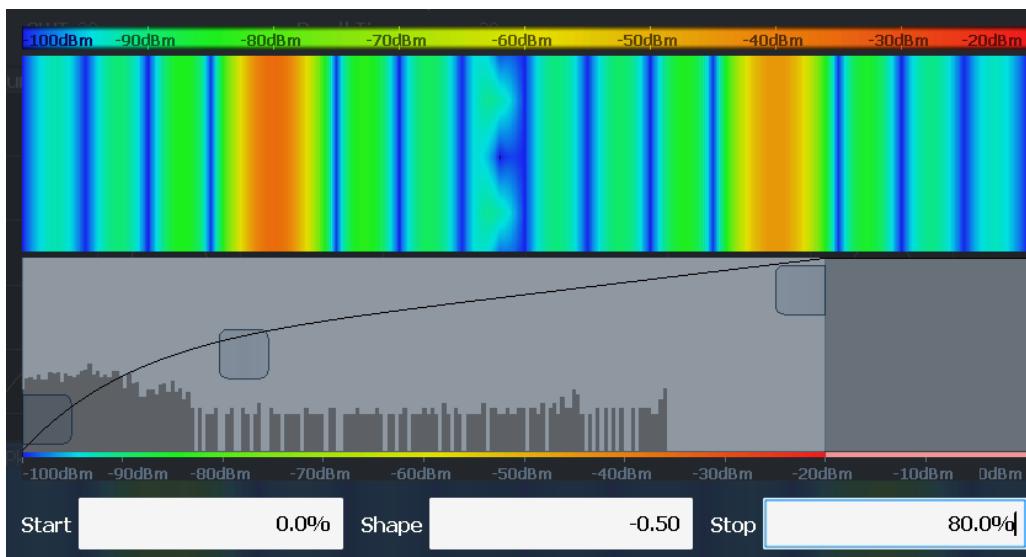

Figure 8-56: Spectrogram with non-linear color curve (shape = -0.5)

### 8.10.2.2 Spectrogram Settings

**Access:** [TRACE] > "Spectrogram Config"

The individual settings available for spectrogram display are described here. For settings on color mapping, see "Color Map Settings" on page 527.

Settings concerning the frames and how they are handled during a sweep are provided as additional sweep settings for spectrogram display.

See Chapter 8.6, "Bandwidth, Filter and Sweep Configuration", on page 434.

Search functions for spectrogram markers are described in Chapter 8.9.3.2, "Marker Search Settings for Spectrograms", on page 474.

- General Spectrogram Settings.....524
- Color Map Settings.....527

#### General Spectrogram Settings

**Access:** [TRACE] > "Spectrogram Config"

This section describes general settings for spectrogram display.

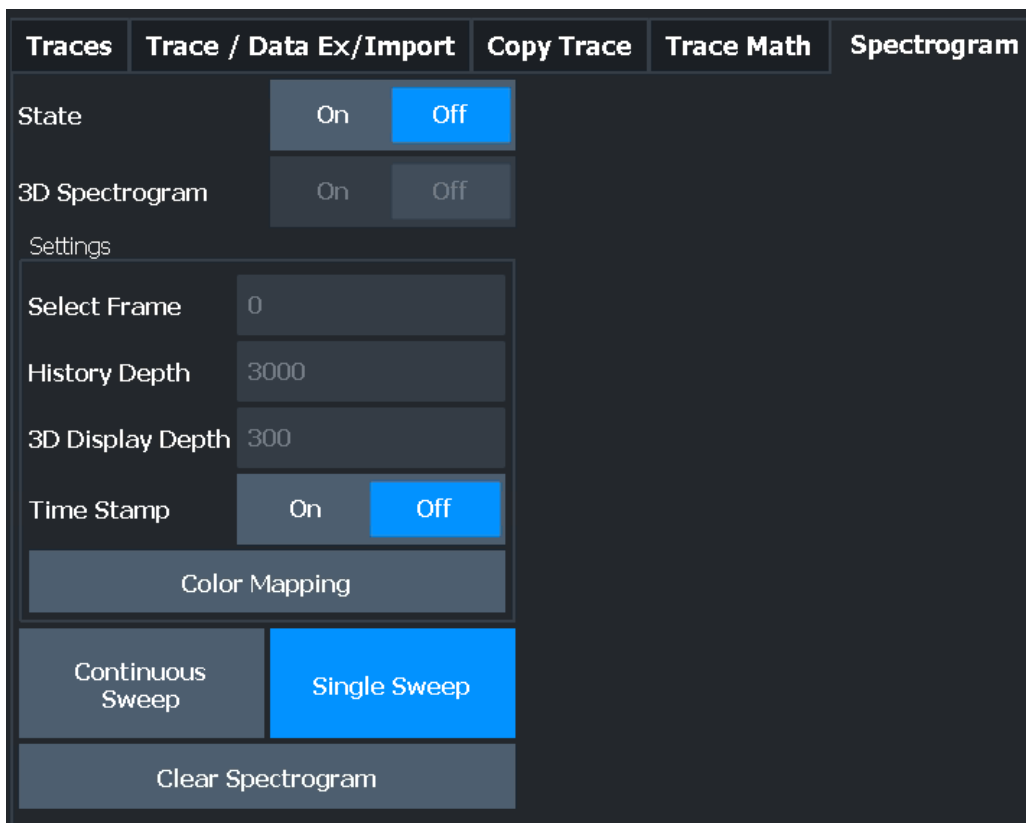

State..... 525

3D Spectrogram State..... 525

Select Frame..... 526

History Depth ..... 526

3-D Display Depth..... 526

Time Stamp ..... 526

Color Mapping ..... 526

Continuous Sweep / Run Cont ..... 526

Single Sweep / Run Single ..... 527

Clear Spectrogram ..... 527

**State**

Activates and deactivates a Spectrogram subwindow.

"On"                    Displays the Spectrogram as a subwindow in the original result display.

"Off"                    Closes the Spectrogram subwindow.

Remote command:

[CALCulate<n>:SPECTrogram:LAYout](#) on page 768

**3D Spectrogram State**

Activates and deactivates a 3-dimensional spectrogram. As opposed to the common 2-dimensional spectrogram, the power is not only indicated by a color mapping, but also in a third dimension, the z-axis.

For details see "[Three-Dimensional Spectrograms](#)" on page 519.

Remote command:

[CALCulate<n>:SPECTrogram:THReedim\[:STATe\]](#) on page 769

### Select Frame

Selects a specific frame, loads the corresponding trace from the memory, and displays it in the Spectrum window.

Note that activating a marker or changing the position of the active marker automatically selects the frame that belongs to that marker.

This function is only available in single sweep mode or if the sweep is stopped, and only if a spectrogram is selected.

The most recent frame is number 0, all previous frames have a negative number.

For more details see ["Time Frames"](#) on page 517.

Remote command:

[CALCulate<n>:SPECTrogram:FRAMe:SELeCt](#) on page 768

### History Depth

Sets the number of frames that the R&S FPL1000 stores in its memory.

The maximum number of frames depends on the [Sweep Points](#).

If the memory is full, the R&S FPL1000 deletes the oldest frames stored in the memory and replaces them with the new data.

Remote command:

[CALCulate<n>:SPECTrogram:HDEPth](#) on page 768

### 3-D Display Depth

Defines the number of frames displayed in a 3-dimensional spectrogram.

For details see ["Three-Dimensional Spectrograms"](#) on page 519.

### Time Stamp

Activates and deactivates the timestamp. The timestamp shows the system time while the measurement is running. In single sweep mode or if the sweep is stopped, the timestamp shows the time and date of the end of the sweep.

When active, the timestamp replaces the display of the frame number.

Remote command:

[CALCulate<n>:SPECTrogram:TSTamp\[:STATe\]](#) on page 771

[CALCulate<n>:SPECTrogram:TSTamp:DATA?](#) on page 770

### Color Mapping

Opens the "Color Mapping" dialog.

For details see ["Color Maps"](#) on page 521.

### Continuous Sweep / Run Cont

After triggering, starts the sweep and repeats it continuously until stopped. This is the default setting.

After triggering, starts the measurement and repeats it continuously until stopped.

While the measurement is running, the "Continuous Sweep" softkey and the [RUN CONT] key are highlighted. The running measurement can be aborted by selecting the highlighted softkey or key again. The results are not deleted until a new measurement is started.

**Note:** Sequencer. If the Sequencer is active, the "Continuous Sweep" softkey only controls the sweep mode for the currently selected channel setup. However, the sweep mode only takes effect the next time the Sequencer activates that channel setup, and only for a channel-defined sequence. In this case, a channel setup in continuous sweep mode is swept repeatedly.

Furthermore, the [RUN CONT] key controls the Sequencer, not individual sweeps. [RUN CONT] starts the Sequencer in continuous mode.

For details on the Sequencer, see [Chapter 6.4.1, "The Sequencer Concept"](#), on page 89.

Remote command:

`INITiate<n>:CONTinuous` on page 589

### Single Sweep / Run Single

After triggering, starts the number of sweeps set in "Sweep Count". The measurement stops after the defined number of sweeps has been performed.

While the measurement is running, the "Single Sweep" softkey and the [RUN SINGLE] key are highlighted. The running measurement can be aborted by selecting the highlighted softkey or key again.

**Note:** Sequencer. If the Sequencer is active, the "Single Sweep" softkey only controls the sweep mode for the currently selected channel setup. However, the sweep mode only takes effect the next time the Sequencer activates that channel setup, and only for a channel-defined sequence. In this case, the Sequencer sweeps a channel setup in single sweep mode only once.

Furthermore, the [RUN SINGLE] key controls the Sequencer, not individual sweeps. [RUN SINGLE] starts the Sequencer in single mode.

If the Sequencer is off, only the evaluation for the currently displayed channel setup is updated.

For details on the Sequencer, see [Chapter 6.4.1, "The Sequencer Concept"](#), on page 89.

Remote command:

`INITiate<n>[:IMMediate]` on page 590

`CALCulate<n>:SPECTrogram:CONTinuous` on page 767

### Clear Spectrogram

Resets the spectrogram result display and clears the history buffer.

This function is only available if a spectrogram is selected.

Remote command:

`CALCulate<n>:SPECTrogram:CLEar[:IMMediate]` on page 766

### Color Map Settings

**Access:** "Overview" > "Analysis" > "Traces" > "Spectrogram" > "Color Mapping"

or: [TRACE] > "Spectrogram Config" > "Color Mapping"

For more information on color maps see "Color Maps" on page 521. For details on changing color mapping settings see "How to Configure the Color Mapping" on page 531.

In addition to the available color settings, the dialog box displays the current color map and provides a preview of the display with the current settings.

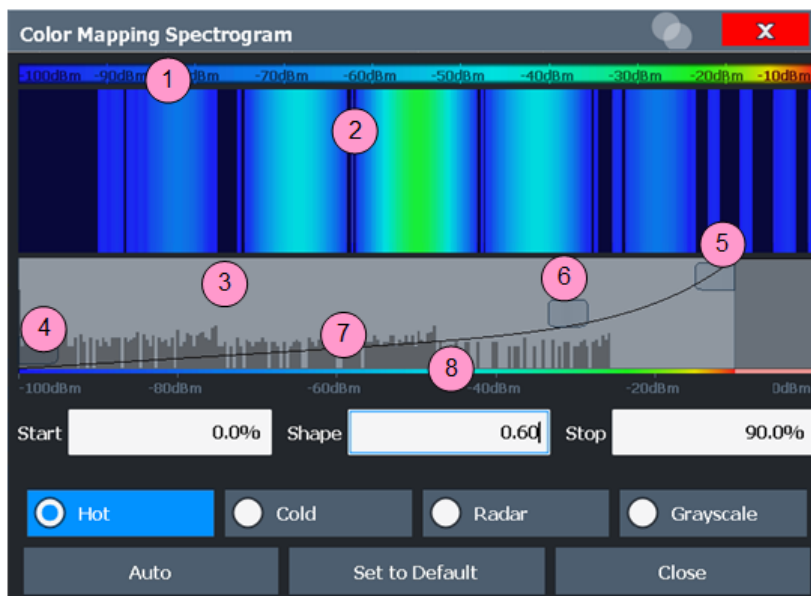

**Figure 8-57: Color Mapping dialog box**

- 1 = Color map: shows the current color distribution
- 2 = Preview pane: shows a preview of the spectrogram with any changes that you make to the color scheme
- 3 = Color curve pane: graphical representation of all settings available to customize the color scheme
- 4/5 = Color range start and stop sliders: define the range of the color map or amplitudes for the spectrogram
- 6 = Color curve slider: adjusts the focus of the color curve
- 7 = Histogram: shows the distribution of measured values
- 8 = Scale of the horizontal axis (value range)

|                                      |     |
|--------------------------------------|-----|
| Start / Stop .....                   | 528 |
| Shape .....                          | 528 |
| Hot / Cold / Radar / Grayscale ..... | 529 |
| Auto .....                           | 529 |
| Set to Default .....                 | 529 |
| Close.....                           | 529 |

### Start / Stop

Defines the lower and upper boundaries of the value range of the spectrogram.

Remote command:

`DISPlay[:WINDow<n>]:SPECTrogram:COLor:LOWer` on page 772

`DISPlay[:WINDow<n>]:SPECTrogram:COLor:UPPer` on page 772

### Shape

Defines the shape and focus of the color curve for the spectrogram result display.

"-1 to <0"      More colors are distributed among the lower values



- "0" Colors are distributed linearly among the values  
 ">0 to 1" More colors are distributed among the higher values

Remote command:

`DISPlay[:WINDow<n>]:SPECTrogram:COLor:SHApe` on page 772

#### Hot / Cold / Radar / Grayscale

Sets the color scheme for the spectrogram.

Remote command:

`DISPlay[:WINDow<n>]:SPECTrogram:COLor[:STYLE]` on page 773

#### Auto

Defines the color range automatically according to the existing measured values for optimized display.

#### Set to Default

Sets the color mapping to the default settings.

Remote command:

`DISPlay[:WINDow<n>]:SPECTrogram:COLor:DEFault` on page 771

#### Close

Saves the changes and closes the dialog box.

### 8.10.2.3 How to Display and Configure a Spectrogram

The following tasks are described here:

- "To display a spectrogram" on page 529
- "To remove the spectrogram display" on page 530
- "To set a marker in the spectrogram" on page 530
- "To configure a spectrogram" on page 530
- "To select a color scheme" on page 531
- "To set the value range graphically using the color range sliders" on page 531
- "To set the value range of the color map numerically" on page 531
- "To set the color curve shape graphically using the slider" on page 533
- "To set the color curve shape numerically" on page 533

#### To display a spectrogram

1. In the "Overview" , select "Display" , then drag the evaluation type "Spectrogram" to the diagram area.  
 Alternatively:
  - a) Select the [TRACE] key and then the "Spectrogram Config" softkey.
  - b) Toggle "Spectrogram" to "On" .
2. To clear an existing spectrogram display, select "Clear Spectrogram" .
3. Start a new measurement using [RUN SINGLE] or [RUN CONT].

The spectrogram is updated continuously with each new sweep.

4. To display the spectrum diagram for a specific time frame:
  - a) Stop the continuous measurement or wait until the single sweep is completed.
  - b) Select the frame number in the diagram footer.
  - c) Enter the required frame number in the edit dialog box.  
Note that the most recent sweep is frame number 0, all previous frames have negative numbers.

#### To remove the spectrogram display

1. Select the [TRACE] key and then the "Spectrogram Config" softkey.
2. Toggle "Spectrogram" to "Off" .

The standard spectrum display is restored.

#### To set a marker in the spectrogram

1. While a spectrogram is displayed, select the [MARKER] key.
2. Select a "Marker" softkey.
3. Enter the frequency or time (x-value) of the marker or delta marker.
4. Enter the frame number for which the marker is to be set, for example 0 for the current frame, or -2 for the second to last frame. Note that the frame number is always 0 or a negative value!

The marker is only visible in the spectrum diagram if it is defined for the currently selected frame. In the spectrogram result display all markers are visible that are positioned on a visible frame.

#### To configure a spectrogram

1. Configure the spectrogram frames:
  - a) Select the [SWEEP] key.
  - b) Select the "Sweep Config" softkey.
  - c) In the "Sweep/Average Count" field, define how many sweeps are to be analyzed to create a single frame.
  - d) In the "Frame Count" field, define how many frames are to be plotted during a single sweep measurement.
  - e) To include frames from previous sweeps in the analysis of the new frame (for "Max Hold" , "Min Hold" and "Average" trace modes only), select "Continue Frame" = "On" .
2. Define how many frames are to be stored in total:
  - a) Select the [TRACE] key and then the "Spectrogram Config" softkey.
  - b) Select the "History Depth" softkey.
  - c) Enter the maximum number of frames to store.
3. Optionally, replace the frame number by a time stamp by toggling the "Time Stamp" softkey to "On" .

- If necessary, adapt the color mapping for the spectrogram to a different value range or color scheme as described in ["How to Configure the Color Mapping"](#) on page 531.

### How to Configure the Color Mapping

The color display is highly configurable to adapt the spectrogram to your needs.

The settings for color mapping are defined in the "Color Mapping" dialog box. To display this dialog box, do one of the following:

- Select the color map in the window title bar of the Spectrogram result display.

#### To select a color scheme

You can select which colors are assigned to the measured values.

- ▶ In the "Color Mapping" dialog box, select the option for the color scheme to be used.

#### Editing the value range of the color map

The distribution of the measured values is displayed as a histogram in the "Color Mapping" dialog box. To cover the entire measurement value range, make sure the first and last bar of the histogram are included.

To ignore noise in a spectrogram, for example, exclude the lower power levels from the histogram.



The value range of the color map must cover at least 10% of the value range on the horizontal axis of the diagram, that means, the difference between the start and stop values must be at least 10%.

The value range of the color map can be set numerically or graphically.

#### To set the value range graphically using the color range sliders

- Select and drag the bottom color curve slider (indicated by a gray box at the left of the color curve pane) to the lowest value you want to include in the color mapping.
- Select and drag the top color curve slider (indicated by a gray box at the right of the color curve pane) to the highest value you want to include in the color mapping.

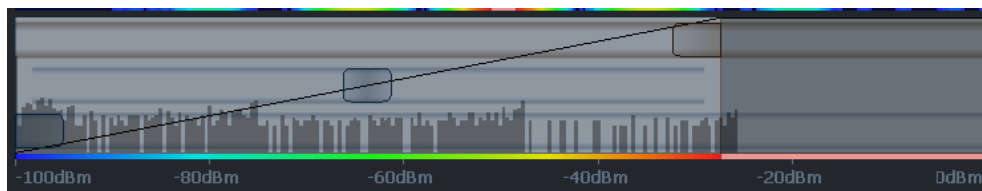

#### To set the value range of the color map numerically

- In the "Start" field, enter the percentage from the left border of the histogram that marks the beginning of the value range.

2. In the "Stop" field, enter the percentage from the right border of the histogram that marks the end of the value range.

**Example:**

The color map starts at -110 dBm and ends at -10 dBm (that is: a range of 100 dB). In order to suppress the noise, you only want the color map to start at -90 dBm. Thus, you enter 10% in the "Start" field. The R&S FPL1000 shifts the start point 10% to the right, to -90 dBm.

**Adjusting the reference level and level range**

Since the color map is configured using percentages of the total value range, changing the reference level and level range of the measurement (and thus the power value range) also affects the color mapping in the spectrogram.

---

**Editing the shape of the color curve**

The color curve is a tool to shift the focus of the color distribution on the color map. By default, the color curve is linear, i.e. the colors on the color map are distributed evenly. If you shift the curve to the left or right, the distribution becomes non-linear. The slope of the color curve increases or decreases. One end of the color palette then covers a large number of results, while the other end distributes several colors over a relatively small result range.

The color curve shape can be set numerically or graphically.

### To set the color curve shape graphically using the slider

- ▶ Select and drag the color curve shape slider (indicated by a gray box in the middle of the color curve) to the left or right. The area beneath the slider is focused, i.e. more colors are distributed there.

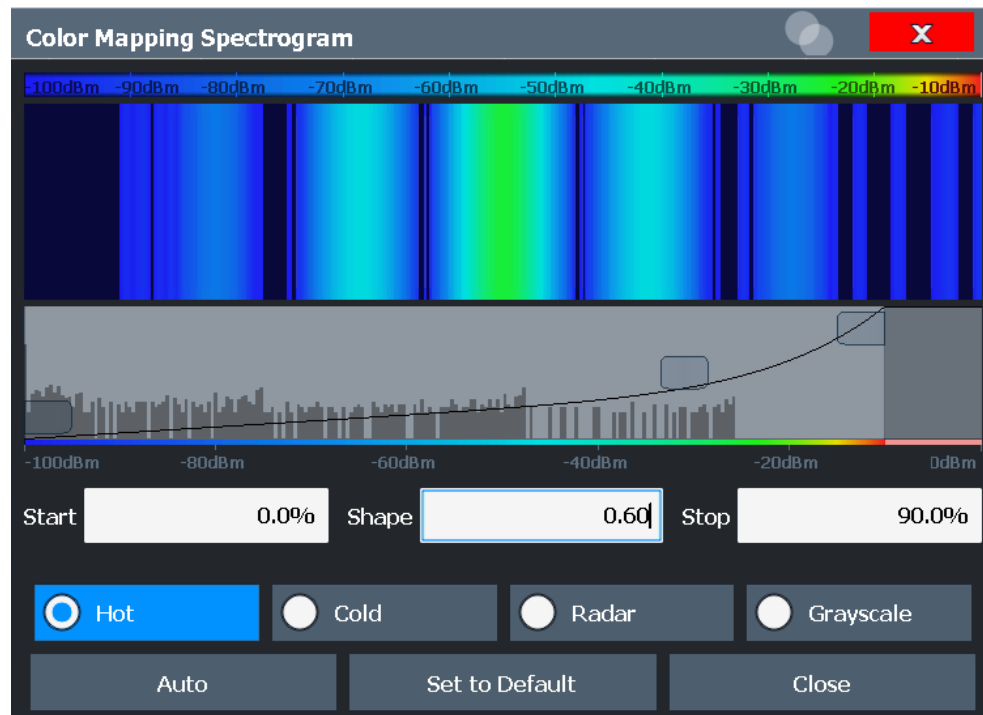

### To set the color curve shape numerically

- ▶ In the "Shape" field, enter a value to change the shape of the curve:
  - A negative value (-1 to <0) focuses the lower values
  - 0 defines a linear distribution
  - A positive value (>0 to 1) focuses the higher values

## 8.10.3 Trace Math

**Access:** [TRACE] > "Trace Math"

If you have several traces with different modes, for example an average trace and a maximum trace, it may be of interest to compare the results of both traces. In this example, you could analyze the maximum difference between the average and maximum values. To analyze the span of result values, you could subtract the minimum trace from the maximum trace. For such tasks, the results from several traces can be combined using mathematical functions.

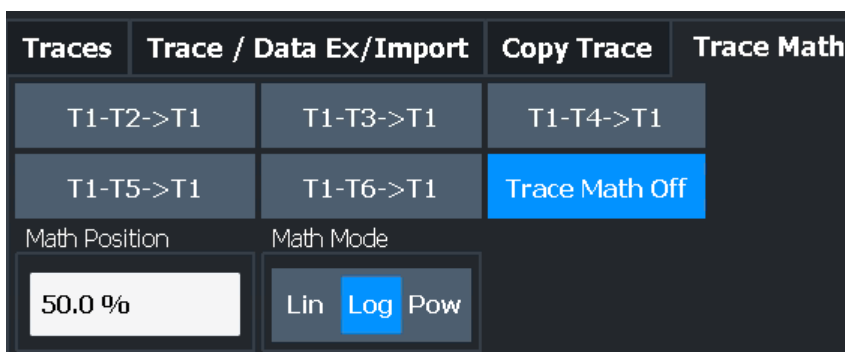

Trace Math Function ..... 534  
 Trace Math Off ..... 534  
 Trace Math Position ..... 534  
 Trace Math Mode ..... 534

**Trace Math Function**

Defines which trace is subtracted from trace 1. The result is displayed in trace 1.

The result refers to the zero point defined with the [Trace Math Position](#) setting. The following subtractions can be performed:

|             |                                 |
|-------------|---------------------------------|
| "T1-T2->T1" | Subtracts trace 2 from trace 1. |
| "T1-T3->T1" | Subtracts trace 3 from trace 1  |
| "T1-T4->T1" | Subtracts trace 4 from trace 1  |
| "T1-T5->T1" | Subtracts trace 5 from trace 1  |
| "T1-T6->T1" | Subtracts trace 6 from trace 1  |

To switch off the trace math, use the [Trace Math Off](#) button.

Remote command:

[CALCulate<n>:MATH<t>\[:EXPRession\]\[:DEFine\]](#) on page 773

[CALCulate<n>:MATH<t>:STATe](#) on page 775

**Trace Math Off**

Deactivates any previously selected trace math functions.

Remote command:

[CALC:MATH:STAT OFF](#), see [CALCulate<n>:MATH<t>:STATe](#) on page 775

**Trace Math Position**

Defines the zero point on the y-axis of the resulting trace in % of the diagram height.

The range of values extends from -100 % to +200 %.

Remote command:

[CALCulate<n>:MATH<t>:POSition](#) on page 774

**Trace Math Mode**

Defines the mode for the trace math calculations.

|         |                                                                                                                                                                                                                                                                                                                                                                                                                                                                                                                                                                                                                                                                                               |
|---------|-----------------------------------------------------------------------------------------------------------------------------------------------------------------------------------------------------------------------------------------------------------------------------------------------------------------------------------------------------------------------------------------------------------------------------------------------------------------------------------------------------------------------------------------------------------------------------------------------------------------------------------------------------------------------------------------------|
| "Lin"   | <p>Activates linear subtraction, which means that the power level values are converted into linear units prior to subtraction. After the subtraction, the data is converted back into its original unit.</p> <p>This setting takes effect if the grid is set to a linear scale. In this case, subtraction is done in two ways (depending on the set unit):</p> <ul style="list-style-type: none"> <li>• The unit is set to either W or dBm: the data is converted into W prior to subtraction, i.e. averaging is done in W.</li> <li>• The unit is set to either V, A, dBmV, dBμV, dBμA or dBpW: the data is converted into V prior to subtraction, i.e. subtraction is done in V.</li> </ul> |
| "Log"   | <p>Activates logarithmic subtraction.</p> <p>This subtraction method only takes effect if the grid is set to a logarithmic scale, i.e. the unit of the data is dBm. In this case the values are subtracted in dBm. Otherwise (i.e. with linear scaling) the behavior is the same as with linear subtraction.</p>                                                                                                                                                                                                                                                                                                                                                                              |
| "Power" | <p>Activates linear power subtraction.</p> <p>The power level values are converted into unit Watt prior to subtraction. After the subtraction, the data is converted back into its original unit.</p> <p>Unlike the linear mode, the subtraction is always done in W.</p>                                                                                                                                                                                                                                                                                                                                                                                                                     |

Remote command:

`CALCulate<n>:MATH<t>:MODE` on page 774

## 8.11 Display and Limit Lines

Display and limit lines help you analyze a measurement trace.



Display lines are only available in the Spectrum and (optional) Analog Demodulation applications.

In the I/Q Analyzer application, lines are only available for measurements in the frequency domain.

**Access:** "Overview" > "Analysis" > "Lines"

For remote operation, see [Chapter 9.8.9, "Configuring Display and Limit Lines"](#), on page 843.

- [Display Lines](#).....536
- [Limit Lines](#).....538

## 8.11.1 Display Lines

### 8.11.1.1 Basics on Display Lines

Display lines help you analyze a trace – as do markers. The function of a display line is comparable to that of a ruler that can be shifted on the trace in order to mark absolute values. They are used exclusively to visually mark relevant frequencies or points in time (zero span), as well as constant level values. It is not possible to check automatically whether the points are below or above the marked level values - use limit lines for that task (see [Chapter 8.11.2.1, "Basics on Limit Lines"](#), on page 538).

Two different types of display lines are provided:

- Two horizontal lines: "Horizontal Line 1" and "Horizontal Line 2".  
These lines are continuous horizontal lines across the entire width of a diagram and can be shifted up and down.
- Two vertical lines: "Vertical Line 1" and "Vertical Line 2".  
These lines are continuous vertical lines across the entire height of the diagram and can be shifted left and right.

#### Lables

Each line is identified by one of the following abbreviations in the diagrams:

- H1: "Horizontal Line 1"
- H2: "Horizontal Line 2"
- V1: "Vertical Line 1"
- V2: "Vertical Line 2"

### 8.11.1.2 Display Line Settings

**Access:** "Overview" > "Analysis" > "Lines" > "Display Lines"

Two vertical and two horizontal lines can be defined in the display.



| Line Config       |                                               |
|-------------------|-----------------------------------------------|
| Limit Lines       | Display Lines                                 |
| Vertical Line 1   | <input type="checkbox"/> 0.0 Hz               |
| Vertical Line 2   | <input type="checkbox"/> 0.0 Hz               |
| Horizontal Line 1 | <input checked="" type="checkbox"/> -20.0 dBm |
| Horizontal Line 2 | <input type="checkbox"/> 0.0 dBm              |

|                                             |     |
|---------------------------------------------|-----|
| Vertical Line <x>.....                      | 537 |
| Horizontal Line 1 / Horizontal Line 2 ..... | 537 |

### Vertical Line <x>

Activates a vertical display line in the diagram at the specified point of the x-axis, depending on the scale of the axis.

Remote command:

[CALCulate<n>:FLINE<dl>](#) on page 844

[CALCulate<n>:FLINE<dl>](#) on page 844

[CALCulate<n>:TLINE<dl>](#) on page 844

[CALCulate<n>:TLINE<dl>](#) on page 844

### Horizontal Line 1 / Horizontal Line 2

Activates a horizontal display line (H1 or H2) in the diagram at the specified point of the y-axis.

Remote command:

[CALCulate<n>:DLINE<dl>](#) on page 843

[CALCulate<n>:DLINE<dl>](#) on page 843

#### 8.11.1.3 Defining Display Lines

1. Display lines are configured in the "Lines Config" dialog box. To display this dialog box, press the [Lines] key and then "Lines Config" .
2. Select the "Display Lines" tab.
3. To define a vertical line:
  - a) select "Vertical Line 1" or 2.
  - b) Enter the x-value at which the line is to be displayed.
4. To define a horizontal line:
  - a) Sselect "Horizontal Line 1" or 2.
  - b) Enter the y-value at which the line is to be displayed.

## 8.11.2 Limit Lines

Limit lines allow you to check automatically whether the measured points are below or above specified values.

- [Basics on Limit Lines](#)..... 538
- [Limit Line Settings and Functions](#)..... 542
- [How to Define Limit Lines](#)..... 549
- [Reference: Limit Line File Format](#)..... 553

### 8.11.2.1 Basics on Limit Lines

Limit lines are used to define amplitude curves or spectral distribution boundaries in the result diagram which are not to be exceeded. They indicate, for example, the upper limits for interference radiation or spurious waves which are allowed from a device under test (DUT). When transmitting information in TDMA systems (e.g. GSM), the amplitude of the bursts in a time slot must adhere to a curve that falls within a specified tolerance band. The lower and upper limits may each be specified by a limit line. Then, the amplitude curve can be controlled either visually or automatically for any violations of the upper or lower limits (GO/NOGO test).

The R&S FPL1000 supports limit lines with a maximum of 200 data points. Eight of the limit lines stored in the instrument can be activated simultaneously. The number of limit lines stored in the instrument is only limited by the capacity of the storage device used.

Limit line data can also be exported to a file in ASCII (CSV) format for further evaluation in other applications. Limit lines stored in the specified ASCII (CSV) format can also be imported to the R&S FPL1000 for other measurements.

#### Compatibility

Limit lines are compatible with the current measurement settings, if the following applies:

- The x unit of the limit line has to be identical to the current setting.
- The y unit of the limit line has to be identical to the current setting with the exception of dB based units; all dB based units are compatible with each other.

#### Validity

Only limit lines that fulfill the following conditions can be activated:

- Each limit line must consist of a minimum of 2 and a maximum of 200 data points.
- The frequencies/times for each data point must be defined in ascending order; however, for any single frequency or time, two data points may be entered (to define a vertical segment of a limit line).
- Gaps in frequency or time are not allowed. If gaps are desired, two separate limit lines must be defined and then both enabled.
- The entered frequencies or times need not necessarily be selectable in R&S FPL1000. A limit line may also exceed the specified frequency or time range. The minimum frequency for a data point is -200 GHz, the maximum frequency is

200 GHz. For the time range representation, negative times may also be entered. The allowed range is -1000 s to +1000 s.

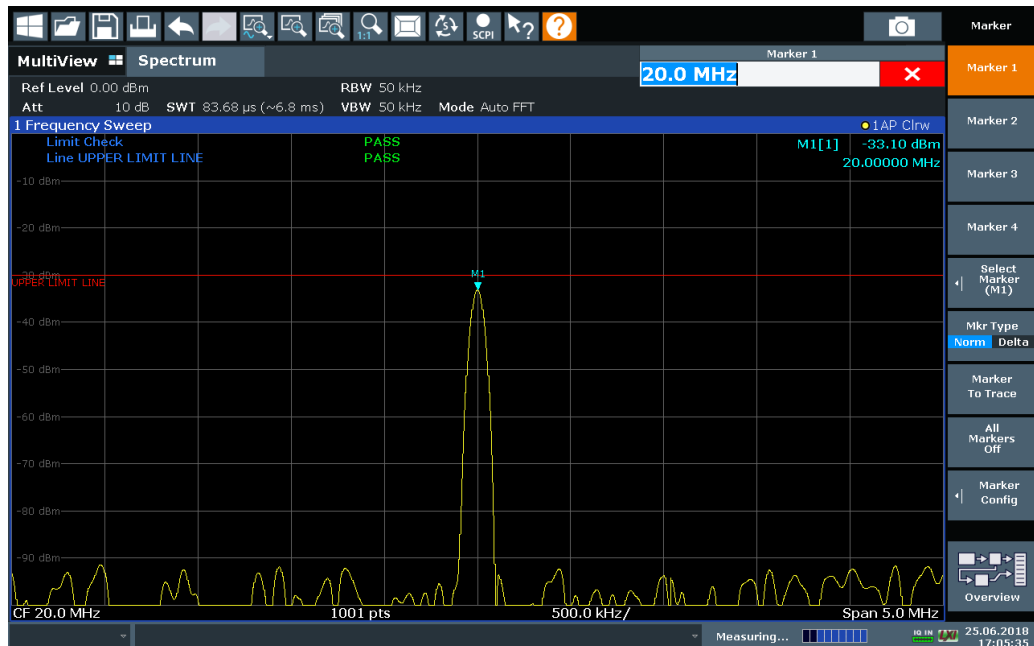

Figure 8-58: Example for an upper limit line

### Limits and Margins

Limit lines define strict values that must not be exceeded by the measured signal. A **margin** is similar to a limit, but less strict and it still belongs to the valid data range. It can be used as a warning that the limit is almost reached. The margin is not indicated by a separate line in the display, but if it is violated, a warning is displayed. Margins are defined as lines with a fixed distance to the limit line.

To check the signal for maximum levels you must define an **upper limit**, whereas to check the signal for minimum levels you must define a **lower limit**.

Limits can be defined relative to the reference level, the beginning of the time scale, or the center frequency, or as absolute values.

Relative scaling is suitable, for example, if masks for bursts are to be defined in zero span, or if masks for modulated signals are required in the frequency domain.

### Thresholds

If the y-axis for the limit line data points uses relative scaling, an additional absolute **threshold** can be defined for the limit check. In this case, both the threshold value and the relative limit line must be exceeded before a violation occurs.

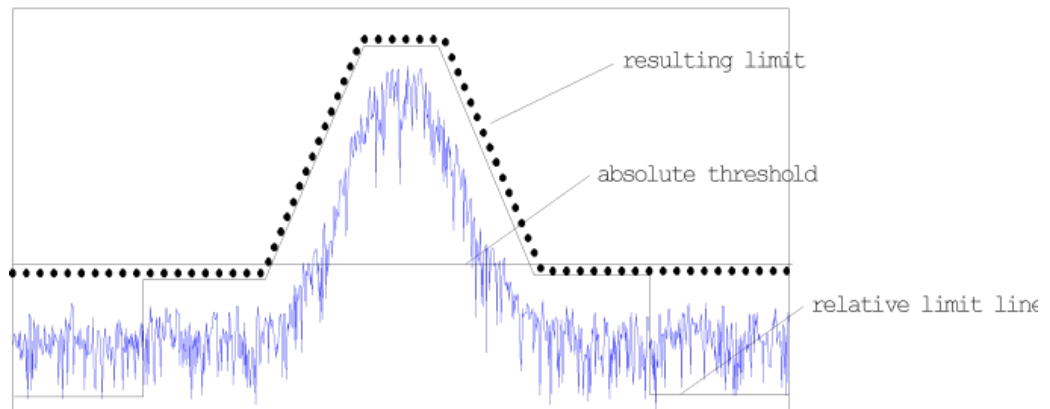

### Offsets and Shifting

A configured limit line can easily be moved vertically or horizontally. Two different methods to do so are available:

- An **offset** moves the entire line in the diagram without editing the configured values or positions of the individual data points. This option is only available if relative scaling is used.  
Thus, a new limit line can be easily generated based upon an existing limit line which has been shifted horizontally or vertically.
- Defining a **shift** width for the values or position of the individual data points changes the line configuration, thus changing the position of the line in the diagram.

### Limit Check Results

A limit check is automatically performed as soon as any of the limit lines is activated ("Visibility" setting). Only the specified "Traces to be Checked" are compared with the active limit lines. The status of the limit check for each limit line is indicated in the diagram. If a violation occurs, the limit check status is set to "MARG" for a margin violation, or to "Fail" for a limit violation.

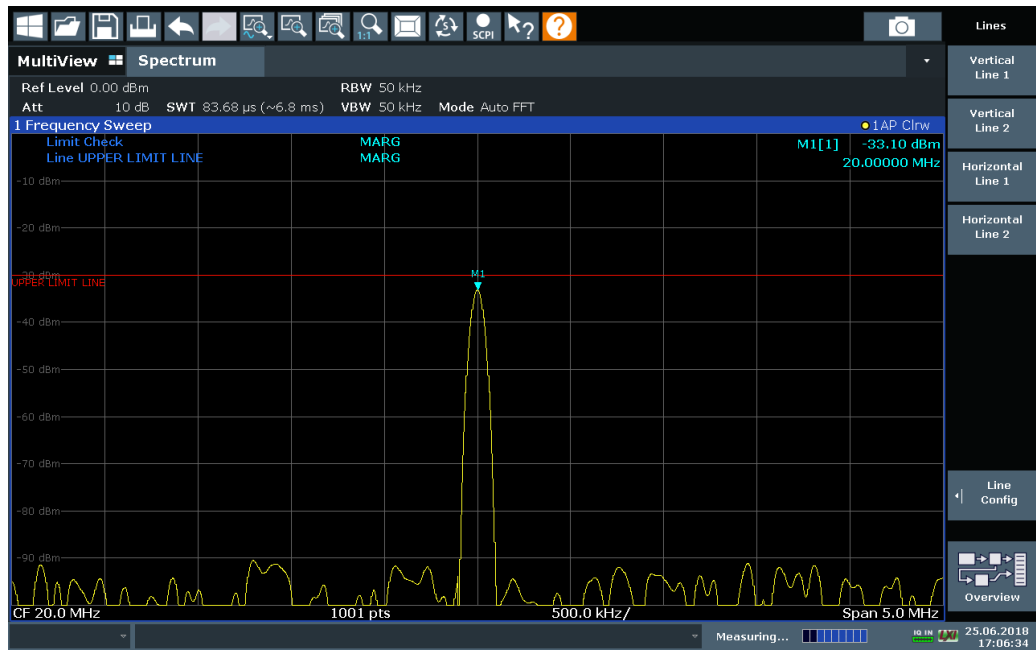

Figure 8-59: Margin violation for limit check

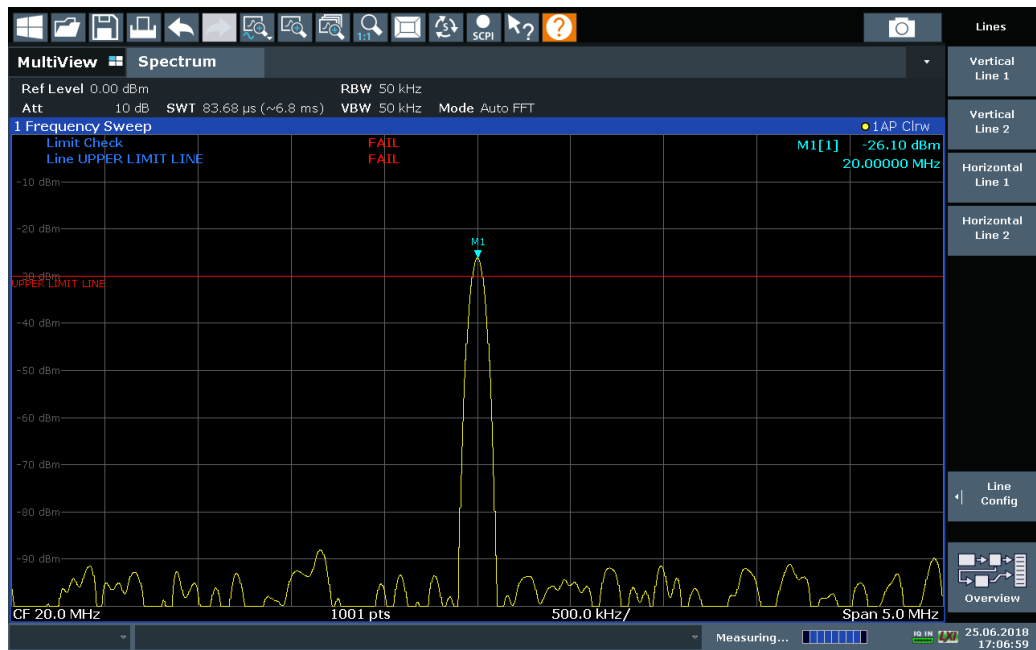

Figure 8-60: Limit violation for limit check



### Storing and Recalling Limit Lines

Limit lines can be stored with the configuration settings so they can be recalled for other measurements at a later time (see [Chapter 7.2.2, "Storing and Recalling Instrument Settings and Measurement Data"](#), on page 102). Note, however, that any changes made to the limit lines *after* storing the configuration file cannot be restored and will be overwritten by the stored values when the configuration file is recalled. Always remember to store the settings again after changing the limit line values.

After recalling measurement settings, the limit line values applied to the measurement may be different to those displayed in the "Limit Lines" dialog box; see ["Saving and recalling transducer and limit line settings"](#) on page 104.

#### 8.11.2.2 Limit Line Settings and Functions

**Access:** "Overview" > "Analysis" > "Lines"

**or:** [LINES] > "Line Config"

Up to 8 limit lines can be displayed simultaneously in the R&S FPL1000. Many more can be stored on the instrument.



### Stored limit line settings

When storing and recalling limit line settings, consider the information provided in ["Saving and recalling transducer and limit line settings"](#) on page 104.

- [Limit Line Management](#).....542
- [Limit Line Details](#).....545

### Limit Line Management

**Access:** "Overview" > "Analysis" > "Lines" > "Limit Lines"

**or:** [LINES] > "Line Config" > "Limit Lines"

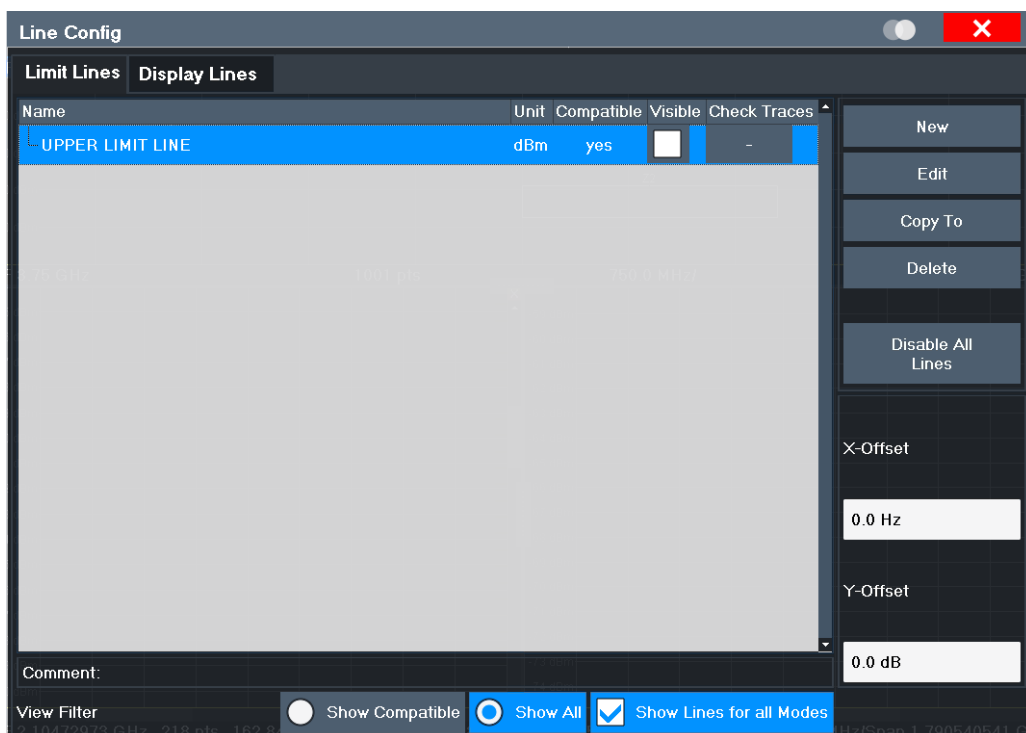

For the limit line overview, the R&S FPL1000 searches for all stored limit lines with the file extension `.LIN` in the `limits` subfolder of the main installation folder. The overview allows you to determine which limit lines are available and can be used for the current measurement.

For details on settings for individual lines see ["Limit Line Details"](#) on page 545.

For more basic information on limit lines see [Chapter 8.11.2.1, "Basics on Limit Lines"](#), on page 538.

|                                                  |     |
|--------------------------------------------------|-----|
| Name .....                                       | 543 |
| Unit .....                                       | 544 |
| Compatibility .....                              | 544 |
| Visibility .....                                 | 544 |
| Traces to be Checked .....                       | 544 |
| Comment .....                                    | 544 |
| Included Lines in Overview ( View Filter ) ..... | 544 |
| └ Show Lines for all Modes .....                 | 544 |
| X-Offset .....                                   | 544 |
| Y-Offset .....                                   | 545 |
| Create New Line .....                            | 545 |
| Edit Line .....                                  | 545 |
| Copy Line .....                                  | 545 |
| Delete Line .....                                | 545 |
| Disable All Lines .....                          | 545 |

**Name**

The name of the stored limit line.

**Unit**

The unit in which the y-values of the data points of the limit line are defined.

**Compatibility**

Indicates whether the limit line definition is compatible with the current measurement settings.

For more information on which conditions a limit line must fulfill to be compatible, see "[Compatibility](#)" on page 538.

**Visibility**

Displays or hides the limit line in the diagram. Up to 8 limit lines can be visible at the same time. Inactive limit lines can also be displayed in the diagram.

Remote command:

`CALCulate<n>:LIMit<li>:LOWer:STATe` on page 851

`CALCulate<n>:LIMit<li>:UPPer:STATe` on page 854

`CALCulate<n>:LIMit<li>:ACTive?` on page 855

**Traces to be Checked**

Defines which traces are automatically checked for conformance with the limit lines. As soon as a trace to be checked is defined, the assigned limit line is active. One limit line can be activated for several traces simultaneously. If any of the "Traces to be Checked" violate any of the active limit lines, a message is indicated in the diagram.

Remote command:

`CALCulate<n>:LIMit<li>:TRACe<t>:CHECK` on page 857

**Comment**

An optional description of the limit line.

**Included Lines in Overview ( View Filter )**

Defines which of the stored lines are included in the overview.

|                   |                                                                                                                                                                                                  |
|-------------------|--------------------------------------------------------------------------------------------------------------------------------------------------------------------------------------------------|
| "Show Compatible" | Only compatible lines<br>Whether a line is compatible or not is indicated in the <a href="#">Compatibility</a> setting.                                                                          |
| "Show All"        | All stored limit lines with the file extension <code>.LIN</code> in the <code>limits</code> subfolder of the main installation folder (if not restricted by "Show Lines for all Modes" setting). |

**Show Lines for all Modes ← Included Lines in Overview ( View Filter )**

If activated (default), limit lines from all applications are displayed. Otherwise, only lines that were created in the Spectrum application are displayed.

Note that limit lines from some applications may include additional properties that are lost when the limit lines are edited in the Spectrum application. In this case a warning is displayed when you try to store the limit line.

**X-Offset**

Shifts a limit line that has been specified for relative frequencies or times (x-axis) horizontally.



This setting does not have any effect on limit lines that are defined by absolute values for the x-axis.

Remote command:

[CALCulate<n>:LIMit<li>:CONTRol:OFFSet](#) on page 848

### Y-Offset

Shifts a limit line that has relative values for the y-axis (levels or linear units such as volt) vertically.

This setting does not have any effect on limit lines that are defined by absolute values for the y-axis.

Remote command:

[CALCulate<n>:LIMit<li>:LOWer:OFFSet](#) on page 850

[CALCulate<n>:LIMit<li>:UPPer:OFFSet](#) on page 853

### Create New Line

Creates a new limit line.

### Edit Line

Edit an existing limit line configuration.

### Copy Line

Copy the selected limit line configuration to create a new line.

Remote command:

[CALCulate<n>:LIMit<li>:COPY](#) on page 856

### Delete Line

Delete the selected limit line configuration.

Remote command:

[CALCulate<n>:LIMit<li>:DELete](#) on page 856

### Disable All Lines

Disable all limit lines in one step.

Remote command:

[CALCulate<n>:LIMit<li>:STATe](#) on page 856

### Limit Line Details

**Access:** "Overview" > "Analysis" > "Lines" > "Limit Lines" > "New" / "Edit" / "Copy To"

**or:** [LINES] > "Line Config" > "Limit Lines" > "New" / "Edit" / "Copy To"

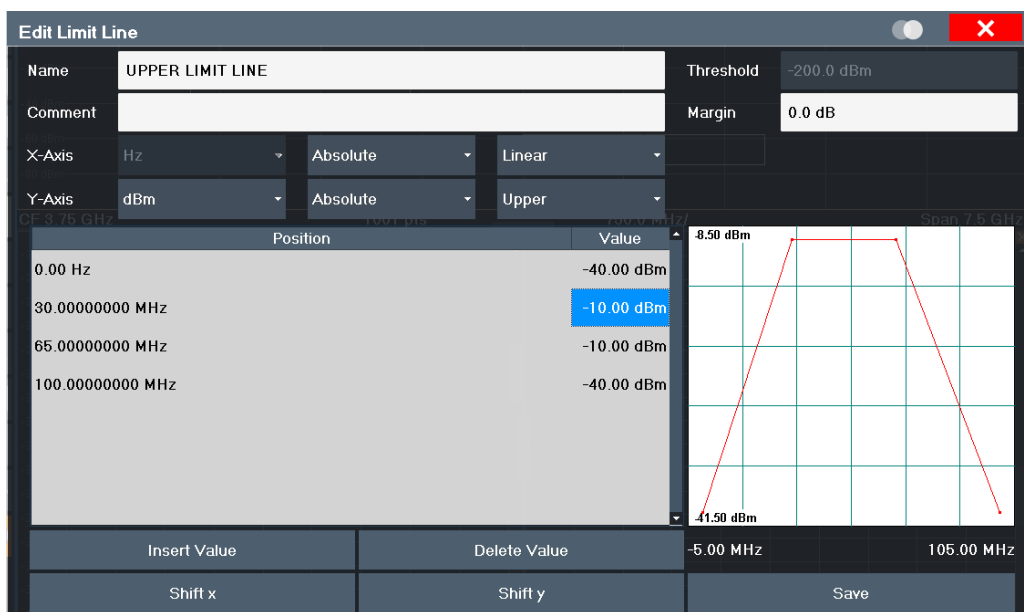

Name .....546

Comment .....546

Threshold ..... 546

Margin ..... 547

X-Axis ..... 547

Y-Axis ..... 547

Data Points ..... 547

Insert Value ..... 548

Delete Value ..... 548

Shift x ..... 548

Shift y ..... 548

Save ..... 548

Import ..... 548

Export ..... 548

**Name**

Defines the limit line name. All names must be compatible with Windows conventions for file names. The limit line data is stored under this name (with a .LIN extension).

Remote command:

CALCulate<n>:LIMit<li>:NAME on page 851

**Comment**

Defines an optional comment for the limit line.

Remote command:

CALCulate<n>:LIMit<li>:COMMeNt on page 846

**Threshold**

Defines an absolute threshold value (only for relative scaling of the y-axis).

For details on thresholds see "Thresholds" on page 539.

Remote command:

`CALCulate<n>:LIMit<li>:LOWer:THReshold` on page 851

`CALCulate<n>:LIMit<li>:UPPer:THReshold` on page 855

### Margin

Defines a margin for the limit line. The default setting is 0 dB (i.e. no margin).

For details on margins see "[Limits and Margins](#)" on page 539.

Remote command:

`CALCulate<n>:LIMit<li>:LOWer:MARGIn` on page 849

`CALCulate<n>:LIMit<li>:UPPer:MARGIn` on page 853

### X-Axis

Describes the horizontal axis on which the data points of the limit line are defined.

Includes the following settings:

- Unit:
  - "Hz" : for frequency domain
  - "s" : for time domain
- Scaling mode: absolute or relative values  
For relative values, the frequencies are referred to the currently set center frequency. In the time domain, the left boundary of the diagram is used as the reference.
- Scaling: linear or logarithmic

Remote command:

`CALCulate<n>:LIMit<li>:LOWer:MODE` on page 849

`CALCulate<n>:LIMit<li>:UPPer:MODE` on page 853

`CALCulate<n>:LIMit<li>:CONTRol:DOMain` on page 847

`CALCulate<n>:LIMit<li>:CONTRol:SPACIng` on page 848

### Y-Axis

Describes the vertical axis on which the data points of the limit line are defined.

Includes the following settings:

- Level unit
- Scaling mode: absolute or relative (dB/%) values  
Relative limit values refer to the reference level.
- Limit type: upper or lower limit; values must stay above the lower limit and below the upper limit to pass the limit check

Remote command:

`CALCulate<n>:LIMit<li>:UNIT` on page 852

`CALCulate<n>:LIMit<li>:LOWer:SPACIng` on page 850

`CALCulate<n>:LIMit<li>:UPPer:SPACIng` on page 854

### Data Points

Each limit line is defined by a minimum of 2 and a maximum of 200 data points. Each data point is defined by its position (x-axis) and value (y-value). Data points must be defined in ascending order. The same position can have two different values.

Remote command:

`CALCulate<n>:LIMit<li>:CONTRol[:DATA]` on page 846

`CALCulate<n>:LIMit<li>:LOWer[:DATA]` on page 849

`CALCulate<n>:LIMit<li>:UPPer[:DATA]` on page 852

### Insert Value

Inserts a data point in the limit line above the selected one in the "Edit Limit Line" dialog box.

### Delete Value

Deletes the selected data point in the "Edit Limit Line" dialog box.

### Shift x

Shifts the x-value of each data point horizontally by the defined shift width (as opposed to an additive offset defined for the entire limit line, see "X-Offset" on page 544).

Remote command:

`CALCulate<n>:LIMit<li>:CONTRol:SHIFt` on page 848

### Shift y

Shifts the y-value of each data point vertically by the defined shift width (as opposed to an additive offset defined for the entire limit line, see "Y-Offset" on page 545).

Remote command:

`CALCulate<n>:LIMit<li>:LOWer:SHIFt` on page 850

`CALCulate<n>:LIMit<li>:UPPer:SHIFt` on page 854

### Save

Saves the currently edited limit line under the name defined in the "Name" field.

### Import

Opens a file selection dialog box and loads the limit line from the selected file in .CSV format.

Note that a valid import file must contain a minimum of required information for the R&S FPL1000.

For details on the file format see [Chapter 8.11.2.4, "Reference: Limit Line File Format"](#), on page 553.

Remote command:

`MMEMorY:LOAD<n>:LIMit` on page 857

### Export

Opens a file selection dialog box and stores the currently displayed limit line to the defined file in .CSV format.

For details on the file format see [Chapter 8.11.2.4, "Reference: Limit Line File Format"](#), on page 553.

The limit line can be imported again later by the R&S FPL1000 for use in other measurements.

Remote command:

`MMEMorY:STORe<n>:LIMit` on page 857

### 8.11.2.3 How to Define Limit Lines

**Access:** "Overview" > "Analysis" > "Lines" > "Limit Lines"

**or:** [LINES] > "Line Config" > "Limit Lines"



#### Limit lines for spurious and SEM measurements

Note that for spurious and SEM measurements, special limit lines can be defined for each frequency range, see "[Limit Lines in SEM Measurements](#)" on page 301 and "[Limit Lines in Spurious Measurements](#)" on page 337. It is strongly recommended that you define limits only via the "Sweep List" dialog for these measurements, not using the [Lines] key.

Any changes to the special limit lines are automatically overwritten when the sweep list settings are changed.

The following tasks are described here:

- "[How to find compatible limit lines](#)" on page 549
- "[How to activate and deactivate a limit check](#)" on page 549
- "[How to edit existing limit lines](#)" on page 550
- "[How to copy an existing limit line](#)" on page 550
- "[How to delete an existing limit line](#)" on page 550
- "[How to configure a new limit line](#)" on page 550
- "[How to move the limit line vertically or horizontally](#)" on page 551

#### How to find compatible limit lines

- ▶ In the "Line Config" dialog box, select the "View Filter" option: "Show Compatible". All stored limit lines with the file extension `.LIN` in the `limits` subfolder of the main installation folder of the instrument that are compatible to the current measurement settings are displayed in the overview.

#### How to activate and deactivate a limit check

A limit check is automatically performed as soon as any of the limit lines is activated.

1. To activate a limit check:  
Select the "Check Traces" setting for a limit line in the overview and select the trace numbers to be included in the limit check. One limit line can be assigned to several traces.  
  
The specified traces to be checked are compared with the active limit lines. The status of the limit check is indicated in the diagram.
2. To deactivate a limit line, deactivate all "Traces to be Checked" for it.  
To deactivate all limit lines at once, select the "Disable All Lines" button.  
  
The limit checks for the deactivated limit lines are stopped and the results are removed from the display.

### How to edit existing limit lines

Existing limit line configurations can be edited.

1. In the "Line Config" dialog box, select the limit line.
2. Select the "Edit" button.
3. Edit the line configuration as described in ["How to configure a new limit line"](#) on page 550.
4. Save the new configuration by selecting the "Save" button.

If the limit line is active, the edited limit line is displayed in the diagram.

### How to copy an existing limit line

1. In the dialog box, select the limit line.
2. Select the "Line Config" "Copy To" button.
3. Define a new name to create a new limit with the same configuration as the source line.
4. Edit the line configuration as described in ["How to configure a new limit line"](#) on page 550.
5. Save the new configuration by selecting the "Save" button.

The new limit line is displayed in the overview and can be activated.

### How to delete an existing limit line

1. In the "Line Config" dialog box, select the limit line.
2. Select the "Delete" button.
3. Confirm the message.

The limit line and the results of the limit check are deleted.

### How to configure a new limit line

1. In the "Line Config" dialog box, select the "New" button.

The "Edit Limit Line" dialog box is displayed. The current line configuration is displayed in the preview area of the dialog box. The preview is updated after each change to the configuration.

2. Define a "Name" and, optionally, a "Comment" for the new limit line.
3. Define the x-axis configuration:
  - Time domain or frequency domain
  - Absolute or relative limits
  - Linear or logarithmic scaling
4. Define the y-axis configuration:
  - Level unit

- Absolute or relative limits
  - Upper or lower limit line
5. Define the data points: minimum 2, maximum 200:
    - a) Select "Insert Value" .
    - b) Define the x-value ( "Position" ) and y-value ( "Value" ) of the first data point.
    - c) Select "Insert Value" again and define the second data point.
    - d) Repeat this to insert all other data points.
      - To insert a data point before an existing one, select the data point and then "Insert Value" .
      - To insert a new data point at the end of the list, move the focus to the line after the last entry and then select "Insert Value" .
      - To delete a data point, select the entry and then "Delete Value" .
  6. Check the current line configuration in the preview area of the dialog box. If necessary, correct individual data points or add or delete some.

If necessary, shift the entire line vertically or horizontally by selecting the "Shift x" or "Shift y" button and defining the shift width.
  7. Optionally, define a "Margin" at a fixed distance to the limit line.

The margin must be within the valid value range and is not displayed in the diagram or preview area.
  8. Optionally, if the y-axis uses relative scaling, define an absolute "Threshold" as an additional criteria for a violation.
  9. Save the new configuration by selecting the "Save" button.

The new limit line is displayed in the overview and can be activated.

#### **How to move the limit line vertically or horizontally**

A configured limit line can easily be moved vertically or horizontally. Thus, a new limit line can be easily generated based upon an existing limit line which has been shifted horizontally.

1. In the "Line Config" dialog box, select the limit line.
2. To shift the complete limit line parallel in the horizontal direction, select the "X-Offset" button and enter an offset value.

To shift the complete limit line parallel in the vertical direction, select the "Y-Offset" button and enter an offset value.
3. To shift the individual data points of a limit line by a fixed value (all at once):
  - a) Select the "Edit" button.
  - b) In the "Edit Limit Line" dialog box, select the "Shift x" or "Shift y" button and define the shift width.
  - c) Save the shifted data points by selecting the "Save" button.

If activated, the limit line is shifted in the diagram.

### How to export a limit line

Limit line configurations can be stored to an ASCII file for evaluation in other programs or to be imported later for other measurements.

1. In the "Line Config" dialog box, select the limit line.
2. Select the "New" or "Edit" button.
3. Define the limit line as described in ["How to configure a new limit line"](#) on page 550.

4. Select "Export" to save the configuration to a file.

You are asked whether you would like to save the configuration internally on the R&S FPL1000 first.

5. Select a file name and location for the limit line.
6. Select the decimal separator to be used in the file.
7. Select "Save" .

The limit line is stored to a file with the specified name and the extension .CSV.

For details on the file format see [Chapter 8.11.2.4, "Reference: Limit Line File Format"](#), on page 553.

### How to import a limit line

Limit line configurations that are stored in an ASCII file and contain a minimum of required data can be imported to the R&S FPL1000.

For details on the required file format see [Chapter 8.11.2.4, "Reference: Limit Line File Format"](#), on page 553.

1. In the "Line Config" dialog box, select the limit line.
2. Select the "New" or "Edit" button.
3. Select "Import" to load a limit line from a file.

You are asked whether you would like to save the current configuration on the R&S FPL1000 first.

4. Select the file name of the limit line.
5. Select the decimal separator that was used in the file.
6. Select "Select" .

The limit line is loaded from the specified file and displayed in the "Edit Limit Line" dialog box.

7. Activate the limit line as described in ["How to activate and deactivate a limit check"](#) on page 549.



#### 8.11.2.4 Reference: Limit Line File Format

Limit line data can be exported to a file in ASCII (CSV) format for further evaluation in other applications. Limit lines stored in the specified ASCII (CSV) format can also be imported to the R&S FPL1000 for other measurements (see ["How to import a limit line"](#) on page 552). This reference describes in detail the format of the export/import files for limit lines. Note that the **bold** data is **mandatory**, all other data is optional.

Different language versions of evaluation programs may require a different handling of the decimal point. Thus, you can define the decimal separator to be used (see ["Decimal Separator"](#) on page 115).

**Table 8-29: ASCII file format for limit line files**

| File contents                                  | Description                                                                |
|------------------------------------------------|----------------------------------------------------------------------------|
| <b>Header data</b>                             |                                                                            |
| <b>sep=;</b>                                   | Separator for individual values (required by Microsoft Excel, for example) |
| <b>Type</b> ;RS_LimitLineDefinition;           | Type of data                                                               |
| <b>FileFormatVersion</b> ;1.00;                | File format version                                                        |
| Date;01.Oct 2006;                              | Date of data set storage                                                   |
| OptionID;SpectrumAnalyzer                      | Application the limit line was created for                                 |
| <b>Name</b> ;RELFREQ1                          | Limit line name                                                            |
| Comment;Defines the upper limit line           | Description of limit line                                                  |
| Mode;UPPER                                     | Type of limit line (upper, lower)                                          |
| ThresholdUnit;LEVEL_DBM                        | Unit of threshold value                                                    |
| ThresholdValue;-200                            | Threshold value                                                            |
| MarginValue;0                                  | Margin value                                                               |
| XAxisScaling;LINEAR                            | Scaling of x-axis linear (LIN) or logarithmic (LOG)                        |
| XAxisUnit;FREQ_HZ                              | Unit of x values                                                           |
| XAxisScaleMode;ABSOLUTE                        | Scaling of x-axis (absolute or relative)                                   |
| YAxisUnit;LEVEL_DB                             | Unit of y values                                                           |
| YAxisScaleMode;ABSOLUTE                        | Scaling of y-axis (absolute or relative)                                   |
| <b>NoOfPoints</b> ;5                           | Number of points the line is defined by                                    |
| <b>Data section for individual data points</b> |                                                                            |
| -4500000000;-50                                | <b>x- and y-values of each data point defining the line</b>                |
| -2000000000;-30                                |                                                                            |
| -1000000000;0                                  |                                                                            |
| 0;-30                                          |                                                                            |
| 2500000000;-50                                 |                                                                            |

## 8.12 Zoomed Displays

You can zoom into the diagram to visualize the measurement results in greater detail. Using the touchscreen or a mouse pointer you can easily define the area to be enlarged.

### Graphical Zoom Versus Measurement Zoom

Graphical zooming is merely a visual tool, it does not change any measurement settings, such as the number of sweep points, the frequency range, or the reference level. Graphical zooming only changes the resolution of the displayed trace points temporarily. You must explicitly activate the graphical zoom function (see [Chapter 8.12.2, "Zoom Functions"](#), on page 556).



#### Graphical zoom and the number of sweep points

Note that (graphical) zooming is merely a visual tool, it does not change any measurement settings, such as the number of sweep points!

You should increase the number of sweep points before zooming, as otherwise the resolution of the trace in the zoomed region is poor (see [Chapter 8.6.1.8, "How Much Data is Measured: Sweep Points and Sweep Count"](#), on page 439).

When you change the display using touch gestures, however, the corresponding measurement settings are adapted (see also [Chapter 5.4.4, "Touchscreen Gestures"](#), on page 78). For example, dragging horizontally in a spectrum display changes the center frequency. Dragging vertically in a spectrum display changes the reference level (for absolute scaling). These changes are permanent for the measurement. This behavior is also referred to as *measurement zoom*, and is active by default in the new R&S FPL1000. However, you can also activate it manually for a display that has already been zoomed graphically. In this case, the temporary changes to the display are replaced by permanent changes to the measurement settings with the same effect.

#### Example:

Assume you have a spectrum display from a spurious emission measurement. You graphically zoom into the area around a detected spur. If you now activate a measurement zoom, the reference level, the center frequency, the frequency span, and the scaling settings are adapted so that the results of the measurement now indicate only the formerly zoomed area around the detected spur.

- [Single Zoom Versus Multiple Zoom](#)..... 554
- [Zoom Functions](#)..... 556
- [How to Zoom Into a Diagram](#)..... 558

### 8.12.1 Single Zoom Versus Multiple Zoom

Two different (graphical) zoom modes are available: single zoom and multiple zoom. A single zoom replaces the current diagram by a new diagram which displays an enlarged extract of the trace. This function can be used repetitively until the required

details are visible. In multiple zoom mode, you can enlarge up to four different areas of the trace simultaneously. An overview window indicates the zoom areas in the original trace, while the zoomed trace areas are displayed in individual windows. The zoom areas can be moved and resized any time. The zoom area that corresponds to the individual zoom display is indicated in the lower right corner, between the scrollbars.

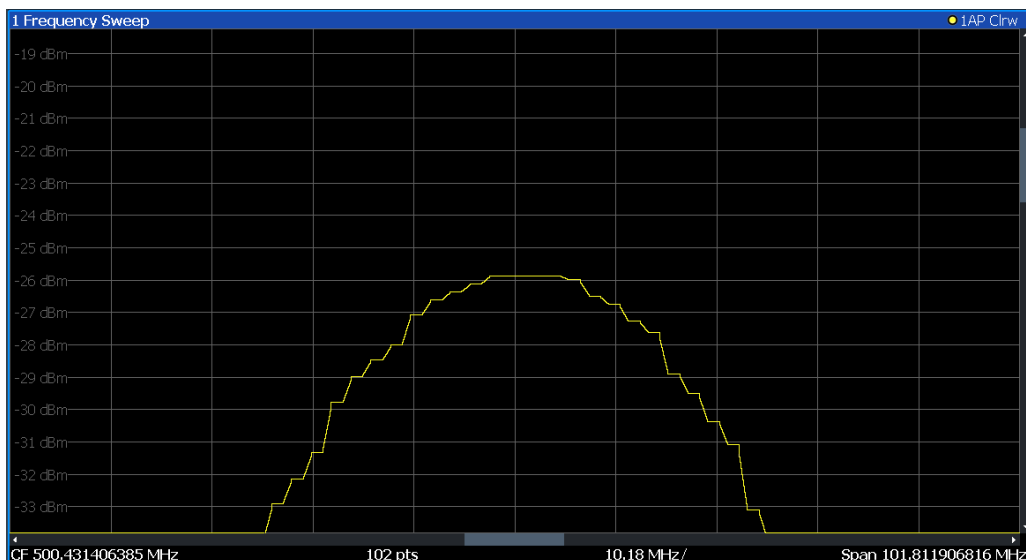

Figure 8-61: Single zoom

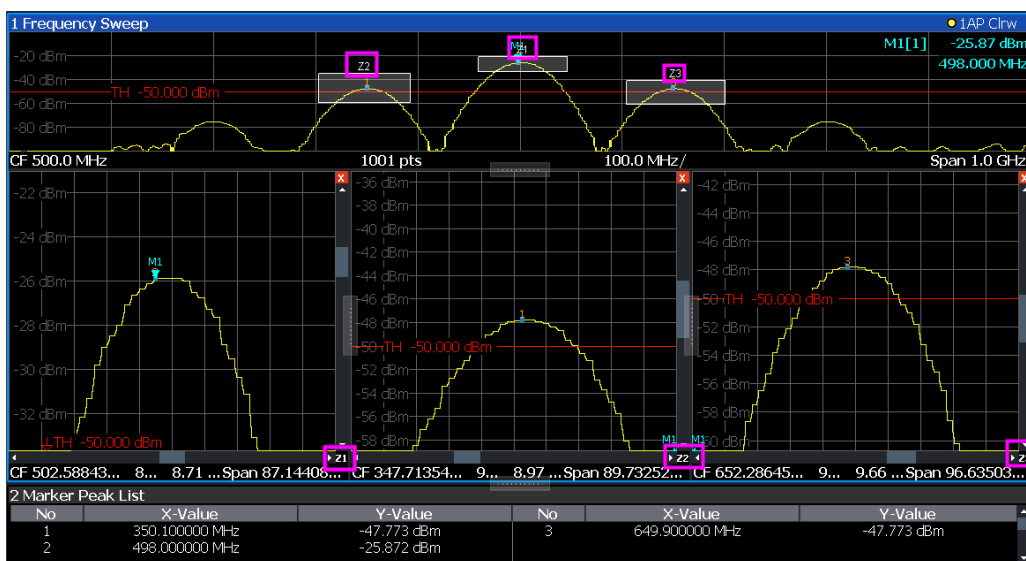

Figure 8-62: Multiple zoom



### Using the zoom area to restrict a peak search

The selected zoom area can be used to restrict the search range for a peak search, but only in single zoom mode (see " Use Zoom Limits " on page 474).

## 8.12.2 Zoom Functions

**Access:** "Zoom" icons in toolbar

|                                                     |     |
|-----------------------------------------------------|-----|
| Single Zoom .....                                   | 556 |
| Multi-Zoom .....                                    | 556 |
| Measurement Zoom.....                               | 556 |
| L Level Lock.....                                   | 557 |
| L X-Lock.....                                       | 557 |
| L Y-Lock.....                                       | 557 |
| L Adapt Measurement to Zoom (selected diagram)..... | 557 |
| Restore Original Display .....                      | 557 |

### Single Zoom



A single zoom replaces the current diagram by a new diagram which displays an enlarged extract of the trace. This function can be used repetitively until the required details are visible.

Remote command:

`DISPlay[:WINDow<n>][:SUBWindow<w>]:ZOOM[:STATe]` on page 757

`DISPlay[:WINDow<n>][:SUBWindow<w>]:ZOOM:AREA` on page 756

### Multi-Zoom



In multiple zoom mode, you can enlarge several different areas of the trace simultaneously. An overview window indicates the zoom areas in the original trace, while the zoomed trace areas are displayed in individual windows. The zoom area that corresponds to the individual zoom display is indicated in the lower right corner, between the scrollbars.

Remote command:

`DISPlay[:WINDow<n>][:SUBWindow<w>]:ZOOM:MULTiple<zn>[:STATe]`  
on page 759

`DISPlay[:WINDow<n>][:SUBWindow<w>]:ZOOM:MULTiple<zn>:AREA`  
on page 758

### Measurement Zoom

As opposed to the graphical zoom, which is merely a visual tool, the measurement zoom adapts the measurement settings such that the data you are interested in is displayed in the required detail. In measurement zoom mode, you can change the display using touch gestures. This is the default operating mode of the R&S FPL1000.

For details on touch gestures see "Operating Basics" in the R&S FPL1000 Getting Started manual.

**Note:** The measurement settings are adapted to practical values based on a suitable grid for the current settings, rather than to unwieldy values that reflect precisely the pixel you happen to tap.

If the measurement zoom leads to undesirable results, you can easily return to the original measurement settings using the "UNDO" function.

When you select the "Measurement Zoom" icon, then tap in a diagram, a dotted rectangle is displayed which you can drag to define the zoom area. This allows you to define the zoom area more precisely than by spreading two fingers in the display.

The measurement zoom function provides further options in a context-sensitive menu, which is displayed when you tap the icon for a second or so (or right-click it). These options concern the behavior of the firmware for subsequent touch gestures on the screen. Note that these settings remain unchanged after a channel preset.

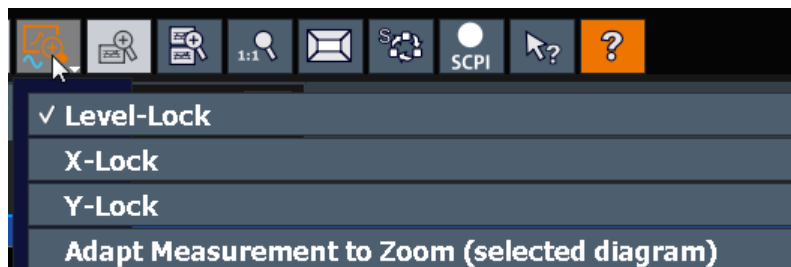

#### Level Lock ← Measurement Zoom

If activated (default), the reference level (and thus the attenuation) is locked, that is: remains unchanged during touch gestures on the screen.

#### X-Lock ← Measurement Zoom

If activated, the x-axis of the diagram is not changed during subsequent touch gestures.

#### Y-Lock ← Measurement Zoom

If activated, the y-axis of the diagram is not changed during subsequent touch gestures.

#### Adapt Measurement to Zoom (selected diagram) ← Measurement Zoom

If you already performed a graphical zoom using the "Single Zoom" on page 556 or "Multi-Zoom" on page 556 functions, this function automatically adapts the measurement settings to maintain the currently zoomed display.

#### Restore Original Display



Restores the original display, that is, the originally calculated displays for the entire capture buffer, and closes all zoom windows.

**Note:** This function only restores graphically zoomed displays. Measurement zooms, for which measurement settings were adapted, are recalculated based on the adapted measurement settings. In this case, the zoomed display is maintained.

Remote command:

Single zoom:

`DISPlay[:WINDow<n>] [:SUBWindow<w>]:ZOOM[:STATe]` on page 757

Multiple zoom:

`DISPlay[:WINDow<n>][:SUBWindow<w>]:ZOOM:MULTiple<zn>[:STATe]`  
on page 759 (for each multiple zoom window)

### 8.12.3 How to Zoom Into a Diagram

The remote commands required to zoom into a display are described in [Chapter 9.8.6, "Zooming into the Display"](#), on page 756.

The following tasks are described here:

- ["To zoom into the diagram at one position"](#) on page 558
- ["To return to original display"](#) on page 559
- ["To zoom into multiple positions in the diagram"](#) on page 559
- ["To maintain a zoomed display permanently"](#) on page 560



For information on how to zoom into a diagram using touch gestures and change the display permanently, see [Chapter 5.4.4, "Touchscreen Gestures"](#), on page 78.

#### To zoom into the diagram at one position

1. 

Click on the "Single Zoom" icon in the toolbar.

Zoom mode is activated.

2. Tap and drag your finger in the diagram to select the area to be enlarged. The selected area is indicated by a dotted rectangle.

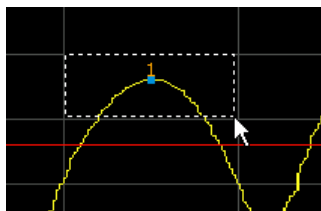

When you leave the touchscreen, the diagram is replaced by the zoomed trace area.

3. Repeat these steps, if necessary, to enlarge the diagram further.



### Scrolling in the zoomed display

You can scroll the diagram area to display the entire diagram using the scrollbars at the right and at the bottom of the diagram.

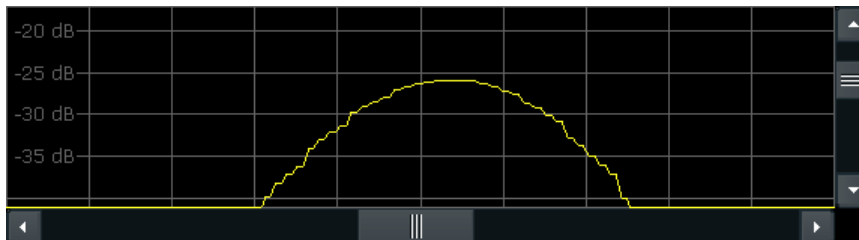

### To return to original display



Click on the "Zoom Off" icon in the toolbar.

The original trace display is restored. Zoom mode remains active, however.

### To zoom into multiple positions in the diagram



1. Click on the "Multi-Zoom" icon in the toolbar.

Multiple zoom mode is activated.

2. Select the first area in the diagram to be enlarged as described in ["To zoom into the diagram at one position"](#) on page 558. The selected area is indicated by a dotted rectangle.

When you have completed your selection, the original trace is shown in an overview diagram with the selected area indicated by a dotted rectangle. The zoomed trace area is displayed in a separate window (see [Figure 8-62](#)).



3. Click on the "Multi-Zoom" icon in the toolbar again.

4. In the overview diagram, select the next area to be enlarged.

The second zoom area is indicated in the overview diagram, and a second zoom window is displayed.

5. Repeat these steps, if necessary, to zoom into further trace areas (up to four).

**To move or change zoom areas**

In multiple zoom mode, you can change the size or position of the individual zoom areas easily at any time.

- ▶ To resize a zoom area, tap directly **on** the corresponding frame in the overview window and drag the line to change the size of the frame.  
To move a zoom area, tap **inside** the corresponding frame in the overview window and drag the frame to the new position.
- The contents of the zoom windows are adapted accordingly.

**To maintain a zoomed display permanently**

Graphical zooming only changes the resolution of the displayed trace points temporarily. In order to change the display permanently, you must change the corresponding measurement settings.

(Note: Performing a measurement zoom automatically adapts the measurement settings to reflect a graphically zoomed display, see ["To perform a measurement zoom"](#) on page 560).

1. Perform a graphical zoom as described in the previous procedures.
2. Select the "Measurement Zoom" icon from the toolbar.
3. Select "Adapt Hardware to Zoom (selected diagram)".



The measurement settings are adapted as required to obtain the zoomed result display.

**To perform a measurement zoom**

Performing a measurement zoom automatically adapts the measurement settings to reflect a graphically zoomed display.



1. Select the "Measurement Zoom" icon from the toolbar.
2. Do one of the following to define the zoom area:
  - Stretch two fingers in the diagram to enlarge the area between them.
  - Tap and drag one finger in the diagram to select the area to be enlarged. The selected area is indicated by a dotted rectangle.

The measurement settings are adapted as required to obtain the zoomed result display.

## 8.13 Importing and Exporting Measurement Results for Evaluation

The R&S FPL1000 provides various evaluation methods for the results of the performed measurements. However, you may want to evaluate the data with further, exter-



nal applications. In this case, you can export the measurement data to a standard format file (ASCII or XML). Some of the data stored in these formats can also be re-imported to the R&S FPL1000 for further evaluation later, for example in other applications.

The following data types can be exported (depending on the application):

- Trace data
- Table results, such as result summaries, marker peak lists etc.
- I/Q data

The following data types can be imported (depending on the application):

- I/Q data



I/Q data can only be imported and exported in applications that process I/Q data, such as the I/Q Analyzer or optional applications.

See the corresponding user manuals for those applications for details.

- [Displaying a Reference Trace - Importing Trace Data](#).....561
- [Trace/Data Ex/Import](#).....563
- [How to Import Traces](#).....566
- [How to Export Trace Data and Numerical Results](#).....567
- [How to Export a Peak List](#).....567
- [Reference: ASCII File Export Format](#).....568

### 8.13.1 Displaying a Reference Trace - Importing Trace Data

Trace data that was stored during a previous measurement can be imported to the Spectrum application, for example as a reference trace.

The data in the import file must have a specified format (see [Chapter 8.13.6, "Reference: ASCII File Export Format"](#), on page 568), and can be stored in .CSV or .DAT format.

#### Trace Mode

The trace mode for the imported traces is set to "View" so that the data is not overwritten immediately during the next sweep. Other trace settings remain unchanged. Thus, **the displayed trace may not comply with the displayed trace settings in the channel bar.**

#### Detector type and number of sweep points

In particular, the detector type and the number of sweep points remain unchanged.

If the detector type of the active trace requires two points per x-value ("Auto Peak"), but the file contains only one, each point is duplicated. If the detector type requires only one point per x-value, but the file contains two, each second point is ignored.

If the file contains more sweep points than the active trace requires, the superfluous points are ignored. If the file does not contain enough sweep points, the missing points are inserted as -200 dBm.

### Units

If the unit of the y-axis values in the file does not correspond to the active result display, the imported values are converted. If no unit is defined in the file, it is assumed to be dBm.

### Importing multiple traces in one file

If the import file contains more than one trace, you can import several traces at once, overwriting the existing trace data for any active trace in the result display with the same trace number. Data from the import file for currently not active traces is not imported.

Alternatively, you can import a single trace only, which is displayed for the trace number specified in "Import to Trace". This list contains all currently active traces in the result display. If a trace with the specified number exists in the import file, that trace is imported. Otherwise, the first trace in the file is imported (indicated by a message in the status bar).

### Example:

The import file contains trace 1, trace 2, and trace 4. The current result display has 4 active traces.

"Import to Trace" = 2: trace 2 of the import file is displayed as trace 2 in the result display.

"Import to Trace" = 3: trace 3 is not available in the import file, thus trace 1 is imported and displayed as trace 3 in the result display

"Import to Trace" is enabled: Trace 1 is imported from the file and replaces trace 1 in the result display.

Trace 2 is imported from the file and replaces trace 2 in the result display.

Trace 4 is imported from the file and replaces trace 4 in the result display.

Trace 3 in the result display remains unchanged.

### Importing spectrogram traces

Trace data can also be imported to an active Spectrogram result display.

Note the following differences that apply in this case:

- The measurement must be stopped before import.
- Only trace 1 is imported to the spectrogram. Any other traces may be imported to a Spectrum display, if available. However, they do not change the spectrogram display, which always refers to trace 1.
- A single spectrum is inserted as a new frame number 0.
- The trace mode is *not* changed to "View" as for Spectrum trace imports.

### 8.13.2 Trace/Data Ex/Import

**Access:** [TRACE] > "Trace Config" > "Trace / Data Export"

The R&S FPL1000 provides various evaluation methods for the results of the performed measurements. However, you may want to evaluate the data with other, external applications. In this case, you can export the measurement data to a standard ASCII format file (DAT or CSV). You can also import existing trace data from a file, for example as a reference trace (Spectrum application only).



The standard data management functions (e.g. saving or loading instrument settings) that are available for all R&S FPL1000 applications are not described here.

See [Chapter 7.2.2, "Storing and Recalling Instrument Settings and Measurement Data"](#), on page 102 for a description of the standard functions.

|                                                                     |     |
|---------------------------------------------------------------------|-----|
| <a href="#">Export all Traces and all Table Results</a> .....       | 563 |
| <a href="#">Include Instrument &amp; Measurement Settings</a> ..... | 564 |
| <a href="#">Trace to Export</a> .....                               | 564 |
| <a href="#">Decimal Separator</a> .....                             | 564 |
| <a href="#">Export Trace to ASCII File</a> .....                    | 564 |
| L <a href="#">File Type</a> .....                                   | 565 |
| L <a href="#">Decimal Separator</a> .....                           | 566 |
| <a href="#">Importing Traces</a> .....                              | 566 |
| L <a href="#">Import All Traces / Import to Trace</a> .....         | 566 |
| L <a href="#">Import ASCII File to Trace</a> .....                  | 566 |

#### Export all Traces and all Table Results

Selects all displayed traces and result tables (e.g. Result Summary, marker table etc.) in the current application for export to an ASCII file.

Alternatively, you can select one specific trace only for export (see [Trace to Export](#) ).

The results are output in the same order as they are displayed on the screen: window by window, trace by trace, and table row by table row.

Remote command:

`FORMat:DEXPort:TRACes` on page 780

**Include Instrument & Measurement Settings**

Includes additional instrument and measurement settings in the header of the export file for result data.

See [Chapter 8.13.6, "Reference: ASCII File Export Format"](#), on page 568 for details.

Remote command:

`FORMat:DEXPort:HEADer` on page 886

**Trace to Export**

Defines an individual trace to be exported to a file.

This setting is not available if [Export all Traces and all Table Results](#) is selected.

**Decimal Separator**

Defines the decimal separator for floating-point numerals for the data export/import files. Evaluation programs require different separators in different languages.

Remote command:

`FORMat:DEXPort:DSEParator` on page 863

**Export Trace to ASCII File**

Saves the selected trace or all traces in the currently active result display to the specified file and directory in the selected ASCII format.

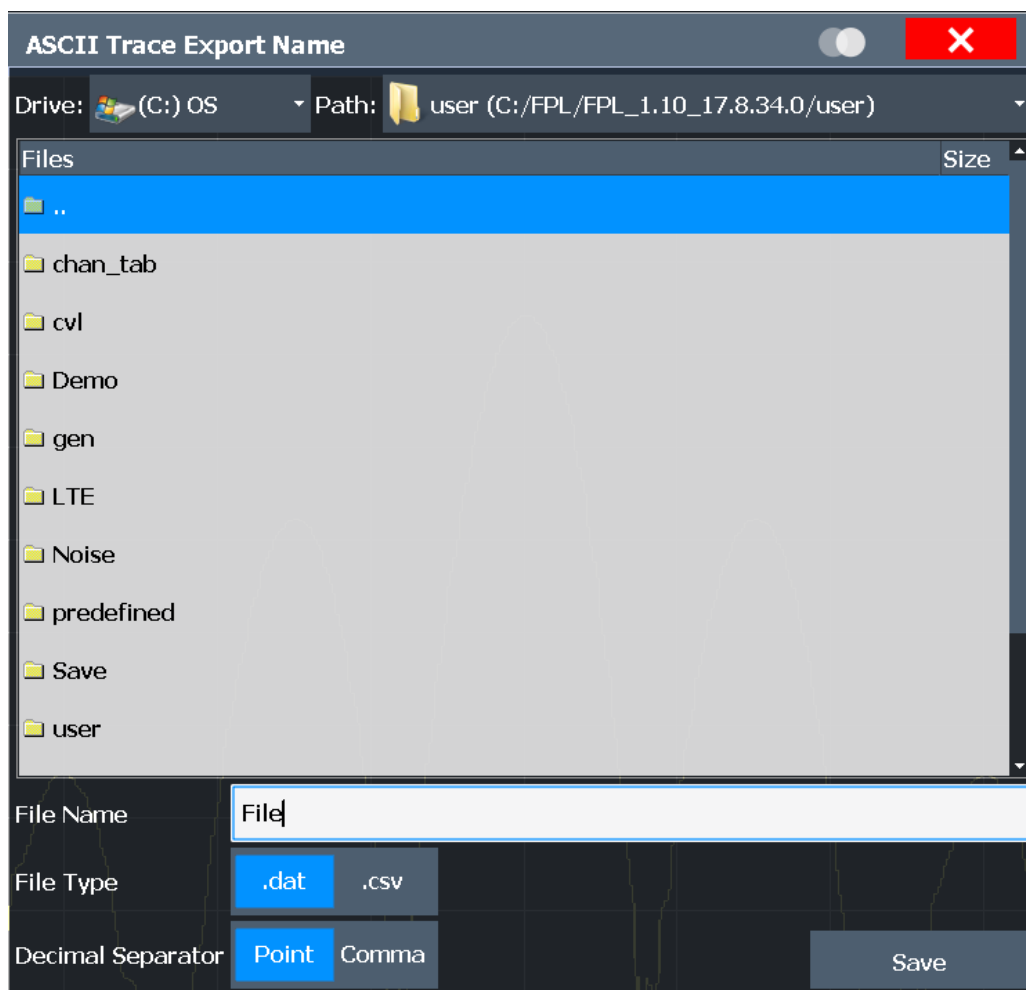

If the spectrogram display is selected when you perform this function, the entire histogram buffer with all frames is exported to a file. The data for a particular frame begins with information about the frame number and the time that frame was recorded. For large history buffers the export operation can take some time.

For details on the file format in the Spectrum application, see [Chapter 8.13.6, "Reference: ASCII File Export Format"](#), on page 568.

Remote command:

[MMEMory:STORe<n>:TRACe](#) on page 781

[MMEMory:STORe<n>:SPECTrogram](#) on page 887

#### **File Type ← Export Trace to ASCII File**

Determines the format of the ASCII file to be imported or exported.

Depending on the external program in which the data file was created or is evaluated, a comma-separated list (CSV) or a plain data format (DAT) file is required.

Remote command:

[FORMat:DEXPort:FORMat](#) on page 779

**Decimal Separator ← Export Trace to ASCII File**

Defines the decimal separator for floating-point numerals for the data export/import files. Evaluation programs require different separators in different languages.

Remote command:

`FORMat:DEXPort:DSEParator` on page 863

**Importing Traces**

Trace data that was stored during a previous measurement can be imported to the Spectrum application, for example as a reference trace.

**Import All Traces / Import to Trace ← Importing Traces**

If the import file contains more than one trace, you can import several traces at once, overwriting the existing trace data for any active trace in the result display with the same trace number. Data from the import file for currently not active traces is not imported.

Alternatively, you can import a single trace only, which is displayed for the trace number specified in "Import to Trace". This list contains all currently active traces in the result display. If a trace with the specified number exists in the import file, that trace is imported. Otherwise, the first trace in the file is imported (indicated by a message in the status bar).

Remote command:

`FORMat:DIMPort:TRACes` on page 780

**Import ASCII File to Trace ← Importing Traces**

Loads one trace or all traces from the selected file in the selected ASCII format (.DAT or .CSV) to the currently active result display.

Remote command:

`FORMat:DIMPort:TRACes` on page 780

### 8.13.3 How to Import Traces

Trace data that was stored during a previous measurement can be imported to the Spectrum application, for example as a reference trace.

**To import trace data**

1. Press the [Trace] key.
2. Select "Trace Config" > "Trace / Data Export" / "Import" .
3. Select "Import All Traces" to import traces for all the currently active traces, or select a specific trace to be imported in "Import to Trace" .
4. Select "Import ASCII File to Trace" .
5. Select the file format in which the data is stored.
6. Select the file that contains the trace data.

7. Select "Select" to close the dialog box and start the import.

### 8.13.4 How to Export Trace Data and Numerical Results

The measured trace data and numerical measurement results in tables can be exported to an ASCII file. For each sweep point the measured trace position and value are output.

The file is stored with a .DAT extension. For details on the storage format see [Chapter 8.13.6, "Reference: ASCII File Export Format"](#), on page 568.



For the results of a Spectrum Emission Mask (SEM) or Spurious Emissions measurement, special file export functions are available, see ["How to Save SEM Result Files"](#) on page 325(SEM) and [" Save Evaluation List "](#) on page 344 (Spurious).

#### To export trace data and table results

1. Select [TRACE] > "Trace Config" > "Trace / Data Export" tab.
2. Select "Export all Traces and all Table Results" to export all available measurement result data for the current application, or select a specific "Trace to Export" .
3. Optionally, select the "Include Instrument & Measurement Settings" option to insert additional information in the export file header.
4. If necessary, change the decimal separator to be used for the ASCII export file.
5. Select the "Export Trace to ASCII File" button.
6. In the file selection dialog box, select the storage location and file name for the export file.
7. Select "Save" to close the dialog box and export the data to the file.

### 8.13.5 How to Export a Peak List

You can save the results of a marker peak list to an ASCII file.

1. Press the [MKR FUNCT] key.
2. Select the "Marker Peak List" softkey.
3. Set the marker peak list "State" to "On" .
4. Press the [RUN SINGLE] key to perform a single sweep measurement and create a marker peak list.
5. Select the "Marker Peak List" softkey to display the "Marker Peak List" dialog box again.
6. If necessary, change the decimal separator to be used for the ASCII export file.

7. Select the "Export Peak List" button.
8. In the file selection dialog box, select the storage location and file name for the export file.
9. Select "Save" to close the dialog box and export the peak list data to the file.

### 8.13.6 Reference: ASCII File Export Format

Trace data can be exported to a file in ASCII format for further evaluation in other applications. This reference describes in detail the format of the export files for result data.

(For details see [Chapter 8.13.4, "How to Export Trace Data and Numerical Results"](#), on page 567)



For a description of the file formats for spectrum emission mask (SEM) measurement settings and results, see [Chapter 8.2.6.8, "Reference: SEM File Descriptions"](#), on page 328.

The file format for Spurious Emissions measurement results is described in [Chapter 8.2.7.6, "Reference: ASCII Export File Format \(Spurious\)"](#), on page 346.

The file consists of the header containing important scaling parameters and a data section containing the trace data. Optionally, the header can be excluded from the file (see "[Include Instrument & Measurement Settings](#)" on page 564).

The data of the file header consist of three columns, each separated by a semicolon: parameter name; numeric value; basic unit. The data section starts with the keyword "Trace <n>" (<n> = number of stored trace), followed by the measured data in one or several columns (depending on the measurement) which are also separated by a semicolon.

The results are output in the same order as they are displayed on the screen: window by window, trace by trace, and table row by table row.

Generally, the format of this ASCII file can be processed by spreadsheet calculation programs, e.g. MS-Excel. Different language versions of evaluation programs may require a different handling of the decimal point. Thus you can define the decimal separator to be used (decimal point or comma, see "[Decimal Separator](#)" on page 115).

If the spectrogram display is selected when you select the "ASCII Trace Export" soft-key, the entire histogram buffer with all frames is exported to a file. The data corresponding to a particular frame begins with information about the frame number and the time that frame was recorded.

**Table 8-30: ASCII file format for trace export in the Spectrum application**

| File contents      | Description      |
|--------------------|------------------|
| <b>Header data</b> |                  |
| Type;R&S FPL1000;  | Instrument model |
| Version;1.00;      | Firmware version |



| File contents                             | Description                                                                                                   |
|-------------------------------------------|---------------------------------------------------------------------------------------------------------------|
| Date;01.Oct 2006;                         | Date of data set storage                                                                                      |
| Mode;ANALYZER;                            | Operating mode                                                                                                |
| Preamplifier;OFF                          | Preamplifier status                                                                                           |
| Transducer; OFF                           | Transducer status                                                                                             |
| Center Freq;55000;Hz                      | Center frequency                                                                                              |
| Freq Offset;0;Hz                          | Frequency offset                                                                                              |
| Start;10000;Hz<br>Stop;100000;Hz          | Start/stop of the display range.<br>Unit: Hz for span > 0, s for span = 0, dBm/dB for statistics measurements |
| Span;90000;Hz                             | Frequency range (0 Hz in zero span and statistics measurements)                                               |
| Ref Level;-30;dBm                         | Reference level                                                                                               |
| Level Offset;0;dB                         | Level offset                                                                                                  |
| Rf Att;20;dB                              | Input attenuation                                                                                             |
| EI Att;2.0;dB                             | Electrical attenuation                                                                                        |
| RBW;100000;Hz                             | Resolution bandwidth                                                                                          |
| VBW;30000;Hz                              | Video bandwidth                                                                                               |
| SWT;0.005;s                               | Sweep time                                                                                                    |
| Sweep Count;20;                           | Number of sweeps set                                                                                          |
| Ref Position;75;%                         | Position of reference level referred to diagram limits (0 % = lower edge)                                     |
| Level Range;100;dB                        | Display range in y direction. Unit: dB with x-axis LOG, % with x-axis LIN                                     |
| x-Axis;LIN;                               | Scaling of x-axis linear (LIN) or logarithmic (LOG)                                                           |
| y-Axis;LOG;                               | Scaling of y-axis linear (LIN) or logarithmic (LOG)                                                           |
| x-Unit;Hz;                                | Unit of x values: Hz with span > 0; s with span = 0; dBm/dB with statistics measurements                      |
| y-Unit;dBm;                               | Unit of y values: dB*/V/A/W depending on the selected unit with y-axis LOG or % with y-axis LIN               |
| <b>Data section for individual window</b> |                                                                                                               |
| Window;1;Frequency Sweep                  | Window number and name                                                                                        |
| Trace 1;;                                 | Selected trace                                                                                                |
| Trace Mode;AVERAGE;                       | Display mode of trace: CLR/WRITE,AVERAGE,MAXHOLD,MINHOLD                                                      |
| Detector;AUTOPEAK;                        | Selected detector                                                                                             |
| Values; 1001;                             | Number of measurement points                                                                                  |

| File contents                                                           | Description                                                                                                                                                                           |
|-------------------------------------------------------------------------|---------------------------------------------------------------------------------------------------------------------------------------------------------------------------------------|
| 10000;-10.3;-15.7<br>10130;-11.5;-16.9<br>10360;-12.0;-17.4<br>...;...; | Measured values: <x value>, <y1>, <y2>; <y2> being available only with detector AUTOPEAK and containing in this case the smallest of the two measured values for a measurement point. |
| <b>Data section for individual trace</b>                                |                                                                                                                                                                                       |
| Trace 2;;                                                               | Next trace in same window                                                                                                                                                             |
| ...                                                                     |                                                                                                                                                                                       |
| <b>Data section for individual window</b>                               |                                                                                                                                                                                       |
| Window;2 ..;                                                            | Name of next window                                                                                                                                                                   |
| <b>Data section for individual trace</b>                                |                                                                                                                                                                                       |
| Trace 1;;                                                               | First trace                                                                                                                                                                           |
| ...                                                                     |                                                                                                                                                                                       |

Table 8-31: ASCII file format for spectrogram trace export

| File contents                     | Description                                                                                                   |
|-----------------------------------|---------------------------------------------------------------------------------------------------------------|
| <b>Header</b>                     |                                                                                                               |
| Type;R&S FPL1000;                 | Instrument model                                                                                              |
| Version;5.00;                     | Firmware version                                                                                              |
| Date;01.Oct 2006;                 | Date of data set storage                                                                                      |
| Mode;ANALYZER; <b>SPECTROGRAM</b> | Operating mode                                                                                                |
| Center Freq;55000;Hz              | Center frequency                                                                                              |
| Freq Offset;0;Hz                  | Frequency offset                                                                                              |
| Span;90000;Hz                     | Frequency range (0 Hz in zero span and statistics measurements)                                               |
| x-Axis;LIN;                       | Scaling of x-axis linear (LIN) or logarithmic (LOG)                                                           |
| Start;10000;Hz<br>Stop;100000;Hz  | Start/stop of the display range.<br>Unit: Hz for span > 0, s for span = 0, dBm/dB for statistics measurements |
| Ref Level;-30;dBm                 | Reference level                                                                                               |
| Level Offset;0;dB                 | Level offset                                                                                                  |
| Ref Position;75; %                | Position of reference level referred to diagram limits (0 % = lower edge)                                     |
| y-Axis;LOG;                       | Scaling of y-axis linear (LIN) or logarithmic (LOG)                                                           |
| Level Range;100;dB                | Display range in y direction. Unit: dB with x-axis LOG, % with x-axis LIN                                     |
| Rf Att;20;dB                      | Input attenuation                                                                                             |
| RBW;100000;Hz                     | Resolution bandwidth                                                                                          |

| File contents                                                           | Description                                                                                                                                                                                                          |
|-------------------------------------------------------------------------|----------------------------------------------------------------------------------------------------------------------------------------------------------------------------------------------------------------------|
| VBW;30000;Hz                                                            | Video bandwidth                                                                                                                                                                                                      |
| SWT;0.005;s                                                             | Sweep time                                                                                                                                                                                                           |
| Trace Mode;AVERAGE;                                                     | Display mode of trace: CLR/WRITE,AVERAGE,MAXHOLD,MINHOLD                                                                                                                                                             |
| Detector;AUTOPEAK;                                                      | Selected detector                                                                                                                                                                                                    |
| Sweep Count;20;                                                         | Number of sweeps set                                                                                                                                                                                                 |
| <b>Data section</b>                                                     |                                                                                                                                                                                                                      |
| Trace 1;;                                                               | Selected trace                                                                                                                                                                                                       |
| x-Unit;Hz;                                                              | Unit of x values: Hz with span > 0; s with span = 0; dBm/dB with statistics measurements                                                                                                                             |
| y-Unit;dBm;                                                             | Unit of y values: dB*/V/A/W depending on the selected unit with y-axis LOG or % with y-axis LIN                                                                                                                      |
| Values; 1001;                                                           | Number of measurement points                                                                                                                                                                                         |
| <b>Frames;2;</b>                                                        | <b>Number of exported frames</b>                                                                                                                                                                                     |
| <b>Frame;0;</b>                                                         | <b>Most recent frame number</b>                                                                                                                                                                                      |
| Timestamp;17.Mar 11;11:27:05.990                                        | <b>Timestamp of this frame</b>                                                                                                                                                                                       |
| 10000;-10.3;-15.7<br>10130;-11.5;-16.9<br>10360;-12.0;-17.4<br>...;...; | Measured values, identical to spectrum data:<br><x value>, <y1>, <y2>; <y2> being available only with detector AUTOPEAK and containing in this case the smallest of the two measured values for a measurement point. |
| <b>Frame;-1;</b>                                                        | <b>Next frame</b>                                                                                                                                                                                                    |
| <b>Timestamp;17.Mar 11;11:27:05.342</b>                                 | <b>Timestamp of this frame</b>                                                                                                                                                                                       |
| ...                                                                     |                                                                                                                                                                                                                      |

## 8.14 Optimizing Measurements

### 8.14.1 Minimizing the Measurement Duration

If you want to minimize the measurement duration, try the following methods to optimize the measurement:

- Reduce the **span** of the measurement to the relevant parts of the signal only.
- Increase the **RBW** to minimize the measurement time; however, consider the requirements of the standard if you need to measure according to standard!
- Reduce the **sweep time** and thus the amount of data to be captured and calculated; however, consider the requirements regarding the standard deviation.

- To determine average (or peak) values, use an **RMS detector (or peak detector) with a higher sweep time** instead of trace averaging to obtain better average power results in less time. Furthermore, enforce the use of the **sweep type "FFT"** (as opposed to "Auto" ; in Sweep mode, the averaging effect of the RMS detector may be less efficient).
- When performing multiple measurements, use **multiple channel setups** to switch between measurements rather than changing the settings within one channel repeatedly.

#### Additional information

An application note discussing measurement speed optimization is available from the Rohde & Schwarz website:

[1EF90: Speeding up Spectrum Analyzer Measurements](#)

### 8.14.2 Improving Averaging Results

Instead of **trace averaging**, use an RMS detector with a higher sweep time to obtain better average power results in less time. Furthermore, enforce the use of the **sweep type "FFT"** (as opposed to "Auto" ; in Sweep mode, the averaging effect of the RMS detector may be less efficient).

In FFT mode, FFTs are calculated per bin and combined using the RMS detector. For trace averaging, on the other hand, the local oscillator must be switched repeatedly for each trace, which takes additional time.

Generally, a higher **sweep time** leads to more data to be averaged and thus stabilizes the results. In FFT mode, a higher sweep time means more FFTs are calculated and combined per bin.

Thus, in the same capture time, the FFT mode with an RMS detector can provide better results than an averaged trace.

## 9 Remote Commands

The commands required to perform measurements in the Spectrum application in a remote environment are described here.



### Compatibility with former R&S signal and spectrum analyzers

As a rule, the R&S FPL1000 supports most commands from previous R&S signal and spectrum analyzers such as the FSQ, FSP, FSU, or FSV. However, the default values, in particular the number of sweep points or particular bandwidths, may vary. Therefore, the R&S FPL1000 can emulate these other devices, including their default values, in order to repeat previous measurements or support existing control applications as in legacy systems.

|                                                                          |     |
|--------------------------------------------------------------------------|-----|
| • <a href="#">Conventions Used in SCPI Command Descriptions</a> .....    | 573 |
| • <a href="#">Common Suffixes</a> .....                                  | 574 |
| • <a href="#">Common Commands</a> .....                                  | 574 |
| • <a href="#">Commands for Remote Instrument Operation</a> .....         | 578 |
| • <a href="#">Selecting the Operating Mode and Application</a> .....     | 579 |
| • <a href="#">Configuring and Performing Measurements</a> .....          | 587 |
| • <a href="#">Remote Commands for Result Displays</a> .....              | 702 |
| • <a href="#">Setting Basic Spectrum RF Measurement Parameters</a> ..... | 711 |
| • <a href="#">Managing Settings and Results</a> .....                    | 861 |
| • <a href="#">Configuring the R&amp;S FPL1000</a> .....                  | 890 |
| • <a href="#">Emulating Other Instruments' Commands</a> .....            | 914 |
| • <a href="#">Using the Status Register</a> .....                        | 947 |
| • <a href="#">Deprecated Commands</a> .....                              | 959 |

### 9.1 Conventions Used in SCPI Command Descriptions

Note the following conventions used in the remote command descriptions:

- **Command usage**  
If not specified otherwise, commands can be used both for setting and for querying parameters.  
If a command can be used for setting or querying only, or if it initiates an event, the usage is stated explicitly.
- **Parameter usage**  
If not specified otherwise, a parameter can be used to set a value and it is the result of a query.  
Parameters required only for setting are indicated as **Setting parameters**.  
Parameters required only to refine a query are indicated as **Query parameters**.  
Parameters that are only returned as the result of a query are indicated as **Return values**.
- **Conformity**  
Commands that are taken from the SCPI standard are indicated as **SCPI con-firmed**. All commands used by the R&S FPL1000 follow the SCPI syntax rules.

- **Asynchronous commands**  
A command which does not automatically finish executing before the next command starts executing (overlapping command) is indicated as an **Asynchronous command**.
- **Reset values (\*RST)**  
Default parameter values that are used directly after resetting the instrument (\*RST command) are indicated as \*RST values, if available.
- **Default unit**  
The default unit is used for numeric values if no other unit is provided with the parameter.
- **Manual operation**  
If the result of a remote command can also be achieved in manual operation, a link to the description is inserted.

## 9.2 Common Suffixes

In the Spectrum application, the following common suffixes are used in remote commands:

*Table 9-1: Common suffixes used in remote commands in the Spectrum application*

| Suffix | Value range | Description                                      |
|--------|-------------|--------------------------------------------------|
| <m>    | 1 to 16     | Marker                                           |
| <n>    | 1 to 16     | Window (in the currently selected channel setup) |
| <t>    | 1 to 6      | Trace                                            |
| <li>   | 1 to 8      | Limit line                                       |

## 9.3 Common Commands

Common commands are described in the IEEE 488.2 (IEC 625-2) standard. These commands have the same effect and are employed in the same way on different devices. The headers of these commands consist of "\*" followed by three letters. Many common commands are related to the Status Reporting System.

Available common commands:

|       |     |
|-------|-----|
| *CAL? | 575 |
| *CLS  | 575 |
| *ESE  | 575 |
| *ESR? | 575 |
| *IDN? | 576 |
| *IST? | 576 |
| *OPC  | 576 |
| *OPT? | 576 |
| *PCB  | 576 |

|            |     |
|------------|-----|
| *PRE.....  | 577 |
| *PSC.....  | 577 |
| *RST.....  | 577 |
| *SRE.....  | 577 |
| *STB?..... | 577 |
| *TRG.....  | 578 |
| *TST?..... | 578 |
| *WAI.....  | 578 |

---

### \*CAL?

Calibration query

Initiates a calibration of the instrument and then queries the calibration status. Responses > 0 indicate errors.

**Note:** If you start a self-alignment remotely, then select the "Local" softkey while the alignment is still running, the instrument only returns to the manual operation state after the alignment is completed.

**Usage:** Query only

**Manual operation:** See " [Start Self Alignment](#) " on page 165

---

### \*CLS

Clear status

Sets the status byte (STB), the standard event register (ESR) and the `EVENT` part of the `QUESTIONABLE` and the `OPERATION` registers to zero. The command does not alter the mask and transition parts of the registers. It clears the output buffer.

**Usage:** Setting only

---

### \*ESE <Value>

Event status enable

Sets the event status enable register to the specified value. The query returns the contents of the event status enable register in decimal form.

**Parameters:**

<Value> Range: 0 to 255

---

### \*ESR?

Event status read

Returns the contents of the event status register in decimal form and then sets the register to zero.

**Return values:**

<Contents> Range: 0 to 255

**Usage:** Query only

---

#### **\*IDN?**

Identification

Returns the instrument identification.

**Usage:** Query only

---

#### **\*IST?**

Individual status query

Returns the contents of the IST flag in decimal form. The IST flag is the status bit which is sent during a parallel poll.

#### **Return values:**

<ISTflag> 0 | 1

**Usage:** Query only

---

#### **\*OPC**

Operation complete

Sets bit 0 in the event status register when all preceding commands have been executed. This bit can be used to initiate a service request. The query writes a "1" into the output buffer when all preceding commands have been executed, which is useful for command synchronization.

---

#### **\*OPT?**

Option identification query

Queries the options included in the instrument. For a list of all available options and their description, refer to the data sheet.

**Usage:** Query only

---

#### **\*PCB <Address>**

Pass control back

Indicates the controller address to which remote control is returned after termination of the triggered action.

#### **Setting parameters:**

<Address> Range: 0 to 30

**Usage:** Setting only

---



---

**\*PRE** <Value>

Parallel poll register enable

Sets parallel poll enable register to the indicated value. The query returns the contents of the parallel poll enable register in decimal form.

**Parameters:**

<Value>                      Range:      0 to 255

---

**\*PSC** <Action>

Power on status clear

Determines whether the contents of the `ENABLE` registers are preserved or reset when the instrument is switched on. Thus a service request can be triggered when the instrument is switched on, if the status registers ESE and SRE are suitably configured. The query reads out the contents of the "power-on-status-clear" flag.

**Parameters:**

<Action>                      0 | 1  
**0**  
The contents of the status registers are preserved.  
**1**  
Resets the status registers.

---

**\*RST**

Reset

Sets the instrument to a defined default status. The default settings are indicated in the description of commands.

The command is equivalent to `SYSTEM:PRESet`.

**Usage:**                      Setting only

---

**\*SRE** <Contents>

Service request enable

Sets the service request enable register to the indicated value. This command determines under which conditions a service request is triggered.

**Parameters:**

<Contents>                      Contents of the service request enable register in decimal form.  
Bit 6 (MSS mask bit) is always 0.  
Range:      0 to 255

---

**\*STB?**

Status byte query

Reads the contents of the status byte in decimal form.

**Usage:** Query only

### \*TRG

Trigger

Triggers all actions waiting for a trigger event. In particular, \*TRG generates a manual trigger signal. This common command complements the commands of the TRIGger subsystem.

\*TRG corresponds to the INITiate:IMMediate command (see INITiate<n>[:IMMediate] on page 590).

**Usage:** Event

### \*TST?

Self-test query

Initiates self-tests of the instrument and returns an error code.

**Note:** If you start a self-test remotely, then select the "Local" softkey while the test is still running, the instrument only returns to the manual operation state after the test is completed. In this case, the self-test cannot be aborted.

#### Return values:

|             |                                                                 |
|-------------|-----------------------------------------------------------------|
| <ErrorCode> | <b>integer &gt; 0 (in decimal format)</b><br>An error occurred. |
|             | <b>0</b><br>No errors occurred.                                 |

**Usage:** Query only

### \*WAI

Wait to continue

Prevents servicing of the subsequent commands until all preceding commands have been executed and all signals have settled (see also command synchronization and \*OPC).

**Usage:** Event

## 9.4 Commands for Remote Instrument Operation

The following commands are required to shutdown or reboot the R&S FPL1000 from a remote PC.

|                                       |     |
|---------------------------------------|-----|
| <a href="#">SYSTem:CLOGging</a> ..... | 579 |
| <a href="#">SYSTem:REBoot</a> .....   | 579 |
| <a href="#">SYSTem:SHUTdown</a> ..... | 579 |

---

### SYSTem:CLOGging <State>

This command turns logging of remote commands on and off.

#### Parameters:

<State>                    ON | OFF | 1 | 0

#### ON | 1

Writes all remote commands that have been sent to a file.

The destination is C :

\Users\Public\Documents\Rohde-Schwarz\Analyzer\ScpiLogging  
ScpiLog.<no.>.

where <no.> is a sequential number

A new log file is started each time logging was stopped and is restarted.

#### OFF | 0

\*RST:                    0

**Manual operation:**    See "[I/O Logging](#)" on page 210

---

### SYSTem:REBoot

This command reboots the instrument, including the operating system.

---

### SYSTem:SHUTdown

This command shuts down the instrument.

## 9.5 Selecting the Operating Mode and Application

The following commands are required to select the operating mode or the application and to configure a Sequencer in a remote environment.

|                                                                                    |     |
|------------------------------------------------------------------------------------|-----|
| • <a href="#">Selecting the Mode and Applications</a> .....                        | 579 |
| • <a href="#">Performing a Sequence of Measurements</a> .....                      | 583 |
| • <a href="#">Programming Example: Performing a Sequence of Measurements</a> ..... | 585 |

### 9.5.1 Selecting the Mode and Applications

|                                                   |     |
|---------------------------------------------------|-----|
| <a href="#">DISPlay:ATAB</a> .....                | 580 |
| <a href="#">INSTrument:CREate:DUPLicate</a> ..... | 580 |
| <a href="#">INSTrument:CREate[:NEW]</a> .....     | 580 |
| <a href="#">INSTrument:CREate:REPLace</a> .....   | 581 |
| <a href="#">INSTrument:DELeTe</a> .....           | 581 |

|                                           |     |
|-------------------------------------------|-----|
| <a href="#">INSTrument:LIST?</a> .....    | 581 |
| <a href="#">INSTrument:REName</a> .....   | 582 |
| <a href="#">INSTrument[:SElect]</a> ..... | 583 |

---

### **DISPlay:ATAB** <State>

This command switches between the MultiView tab and the most recently displayed channel setup. If only one channel setup is active, this command has no effect.

#### **Parameters:**

<State>                    ON | OFF | 0 | 1  
                               **OFF | 0**  
                               Switches the function off  
                               **ON | 1**  
                               Switches the function on

---

### **INSTrument:CREate:DUPLicate**

This command duplicates the currently selected channel setup, i.e. creates a new channel setup of the same type and with the identical measurement settings. The name of the new channel setup is the same as the copied channel setup, extended by a consecutive number (e.g. "IQAnalyzer" -> "IQAnalyzer 2").

The channel setup to be duplicated must be selected first using the `INST:SEL` command.

**Example:**                    `INST:SEL 'IQAnalyzer'`  
                                   `INST:CRE:DUPL`  
                                   Duplicates the channel setup named 'IQAnalyzer' and creates a new channel setup named 'IQAnalyzer2'.

**Usage:**                      Event

**Manual operation:**    See "[Duplicate Current Channel](#)" on page 89

---

### **INSTrument:CREate[:NEW]** <ChannelType>, <ChannelName>

This command adds an additional measurement channel. You can configure up to 10 measurement channels at the same time (depending on available memory).

See also

- [INSTrument\[:SElect\]](#) on page 583
- [INSTrument:DELeTe](#) on page 581

#### **Parameters:**

<ChannelType>                Channel type of the new channel.  
                                   For a list of available channel types see [INSTrument:LIST?](#) on page 581.

<ChannelName>                String containing the name of the channel.  
                                   Note that you can not assign an existing channel name to a new channel; this will cause an error.

**Example:** `INST:CRE SAN, 'Spectrum 2'`  
Adds an additional spectrum display named "Spectrum 2".

**Manual operation:** See " [New Channel Setup](#) " on page 89

#### **INSTrument:CREate:REPLace** <ChannelName1>,<ChannelType>,<ChannelName2>

This command replaces a channel setup with another one.

##### **Setting parameters:**

<ChannelName1> String containing the name of the channel setup you want to replace.

<ChannelType> Channel type of the new channel setup.  
For a list of available channel setup types see [INSTrument:LIST?](#) on page 581.

<ChannelName2> String containing the name of the new channel setup.  
Note: If the specified name for a new channel setup already exists, the default name, extended by a sequential number, is used for the new channel setup (see [INSTrument:LIST?](#) on page 581).  
Channel names can have a maximum of 31 characters, and must be compatible with the Windows conventions for file names. In particular, they must not contain special characters such as ":", "\*", "?".

**Example:** `INST:CRE:REPL 'IQAnalyzer2',IQ,'IQAnalyzer'`  
Replaces the channel setup named "IQAnalyzer2" by a new channel setup of type "IQ Analyzer" named "IQAnalyzer".

**Usage:** Setting only

**Manual operation:** See " [Replace Current Channel Setup](#) " on page 89

#### **INSTrument:DELeTe** <ChannelName>

This command deletes a channel setup.

##### **Setting parameters:**

<ChannelName> String containing the name of the channel setup you want to delete.  
A channel setup must exist in order to be able delete it.

**Usage:** Setting only

**Manual operation:** See "[Closing a channel setup](#)" on page 89

#### **INSTrument:LIST?**

This command queries all active channel setups. This is useful in order to obtain the names of the existing channel setups, which are required in order to replace or delete the channel setups.

**Return values:**

<ChannelType>, For each channel setup, the command returns the channel setup type and channel setup name (see tables below).  
<ChannelName>

Tip: to change the channel setup name, use the [INSTrument:REName](#) command.

**Example:**

INST:LIST?

Result for 3 channel setups:

```
'ADEM', 'Analog Demod', 'IQ', 'IQ Analyzer', 'IQ', 'IQ Analyzer2'
```

**Usage:**

Query only

**Manual operation:**

See "[Changing the Channel Setup Name](#)" on page 70

See "[Defining a channel setup](#)" on page 88

See "[New Channel Setup](#)" on page 89

**Table 9-2: Available channel setup types and default channel setup names**

| Application                  | <ChannelType> Parameter | Default Channel Setup Name*) |
|------------------------------|-------------------------|------------------------------|
| Spectrum                     | SANALYZER               | Spectrum                     |
| Analog Demodulation          | ADEM                    | Analog Demod                 |
| I/Q Analyzer                 | IQ                      | IQ Analyzer                  |
| Noise Figure Measurements    | NOISE                   | Noise                        |
| Vector Signal Analysis (VSA) | DDEM                    | VSA                          |

Note: the default channel setup name is also listed in the table. If the specified name for a new channel setup already exists, the default name, extended by a sequential number, is used for the new channel setup.

---

**INSTrument:REName** <ChannelName1>, <ChannelName2>

This command renames a channel setup.

**Setting parameters:**

<ChannelName1> String containing the name of the channel setup you want to rename.

<ChannelName2> String containing the new channel setup name.  
Note that you cannot assign an existing channel setup name to a new channel setup; this will cause an error.  
Channel names can have a maximum of 31 characters, and must be compatible with the Windows conventions for file names. In particular, they must not contain special characters such as ":", "\*", "?".

**Example:**

INST:REN 'IQAnalyzer2', 'IQAnalyzer3'

Renames the channel setup with the name 'IQAnalyzer2' to 'IQAnalyzer3'.

**Usage:**

Setting only

**Manual operation:** See ["Changing the Channel Setup Name"](#) on page 70

---

**INSTRument[:SElect]** <ChannelType> | <ChannelName>

This command activates a new channel setup with the defined channel setup type, or selects an existing channel setup with the specified name.

Also see

- [INSTRument:CREate\[:NEW\]](#) on page 580

**Parameters:**

<ChannelType> Channel type of the new channel setup.  
For a list of available channel setup types see [INSTRument:LIST?](#) on page 581.

<ChannelName> String containing the name of the channel setup.

**Example:**

```
INST IQ
INST 'MyIQSpectrum'
```

Selects the channel setup named 'MyIQSpectrum' (for example before executing further commands for that channel setup).

**Manual operation:** See ["Spectrum"](#) on page 86  
See ["I/Q Analyzer"](#) on page 86  
See ["Analog Demod"](#) on page 86  
See ["Noise Figure"](#) on page 86  
See ["Defining a channel setup"](#) on page 88  
See ["New Channel Setup"](#) on page 89

## 9.5.2 Performing a Sequence of Measurements

The following commands control the sequencer.

For details on the Sequencer see [Chapter 6.4, "Running a Sequence of Measurements"](#), on page 89.

|                                                    |     |
|----------------------------------------------------|-----|
| <a href="#">INITiate:SEQuencer:ABORt</a> .....     | 583 |
| <a href="#">INITiate:SEQuencer:IMMediate</a> ..... | 584 |
| <a href="#">INITiate:SEQuencer:MODE</a> .....      | 584 |
| <a href="#">SYSTem:SEQuencer</a> .....             | 585 |

---

**INITiate:SEQuencer:ABORt**

This command stops the currently active sequence of measurements. The Sequencer itself is not deactivated, so you can start a new sequence immediately using [INITiate:SEQuencer:IMMediate](#) on page 584.

To deactivate the Sequencer use [SYSTem:SEQuencer](#) on page 585.

**Usage:** Setting only

**Manual operation:** See ["Sequencer State"](#) on page 92

**INITiate:SEQuencer:IMMEDIATE**

This command starts a new sequence of measurements by the Sequencer.

Before this command can be executed, the Sequencer must be activated (see [SYSTem:SEQuencer](#) on page 585).

**Example:**

```
SYST:SEQ ON
Activates the Sequencer.
INIT:SEQ:MODE SING
Sets single sequence mode so each active measurement will be
performed once.
INIT:SEQ:IMM
Starts the sequential measurements.
```

**Manual operation:** See "[Sequencer State](#)" on page 92

**INITiate:SEQuencer:MODE <Mode>**

This command selects the way the R&S FPL1000 application performs measurements sequentially.

Before this command can be executed, the Sequencer must be activated (see [SYSTem:SEQuencer](#) on page 585).

A detailed programming example is provided in [Chapter 9.5.3, "Programming Example: Performing a Sequence of Measurements"](#), on page 585.

**Note:** In order to synchronize to the end of a sequential measurement using \*OPC, \*OPC? or \*WAI you must use `SINGLE` Sequence mode.

For details on synchronization see [Chapter 7.4.1.6, "Command Sequence and Synchronization"](#), on page 185

**Parameters:**

<Mode>

**SINGLE**

Each measurement is performed once (regardless of the channel's sweep mode), considering each channels' sweep count, until all measurements in all active channels have been performed.

**CONTInuous**

The measurements in each active channel are performed one after the other, repeatedly (regardless of the channel's sweep mode), in the same order, until the Sequencer is stopped.

**CDEFined**

First, a single sequence is performed. Then, only those channels in continuous sweep mode (`INIT:CONT ON`) are repeated.

\*RST: CONTInuous



**Example:**            `SYST:SEQ ON`  
 Activates the Sequencer.  
                   `INIT:SEQ:MODE SING`  
 Sets single sequence mode so each active measurement will be performed once.  
                   `INIT:SEQ:IMM`  
 Starts the sequential measurements.

**Manual operation:** See "[Sequencer Mode](#)" on page 92

---

#### **SYSTem:SEQuencer** <State>

This command turns the Sequencer on and off. The Sequencer must be active before any other Sequencer commands (`INIT:SEQ...`) are executed, otherwise an error will occur.

A detailed programming example is provided in [Chapter 9.5.3, "Programming Example: Performing a Sequence of Measurements"](#), on page 585.

#### **Parameters:**

<State>                    `ON | OFF | 0 | 1`

**ON | 1**  
 The Sequencer is activated and a sequential measurement is started immediately.

**OFF | 0**  
 The Sequencer is deactivated. Any running sequential measurements are stopped. Further Sequencer commands (`INIT:SEQ...`) are not available.

\*RST:                    `0`

**Example:**            `SYST:SEQ ON`  
 Activates the Sequencer.  
                   `INIT:SEQ:MODE SING`  
 Sets single Sequencer mode so each active measurement will be performed once.  
                   `INIT:SEQ:IMM`  
 Starts the sequential measurements.  
                   `SYST:SEQ OFF`

**Manual operation:** See "[Sequencer State](#)" on page 92

### 9.5.3 Programming Example: Performing a Sequence of Measurements

This example demonstrates how to perform several measurements in a sequence in a remote environment.

```
//2xSpectrumAnalyzer + 2xIQ, start Sequencer at the end, test OPC?
// -----
```

## Selecting the Operating Mode and Application

```

//-----Preparing the instrument and first channel -----
*RST
//Activate new IQ channel
INSTrument:CREate:NEW IQ,'IQ 1'
//Set sweep count for new IQ channel
SENS:SWEEP:COUNT 6
//Change trace modes for IQ channel
DISP:TRAC1:MODE BLANK
DISP:TRAC2:MODE MAXH
DISP:TRAC3:MODE MINH
//Switch to single sweep mode
INIT:CONT OFF
//switch back to first (default) analyzer channel
INST:SEL 'Spectrum';*WAI
//Switch into SEM
SENSe:SWEEP:MODE ESpectrum
//Load Sem standard file for W-CDMA
SENSe:ESpectrum:PRESet:STANdard 'WCDMA\3GPP\DL\3GPP_DL.xml'
//Set sweep count in Spectrum channel
SENS:SWEEP:COUNT 5

//-----Creating a second measurement channel -----

//Create second IQ channel
INSTrument:CREate:NEW IQ,'IQ 2'
//Set sweep count
SENS:SWEEP:COUNT 2
//Change trace modes
DISP:TRAC1:MODE MAXH
DISP:TRAC2:MODE MINH
//Create new analyzer channel
INSTrument:CREate:NEW SANalyzer,'Spectrum 2'
//Activate ACLR measurement in channel 'Spectrum 2'
CALCulate:MARKer:FUNCTion:POWer:SElect ACPower
//Load W-CDMA Standard
CALCulate:MARKer:FUNCTion:POWer:PRESet FW3Gppcdma
//Change trace modes
DISP:TRAC2:MODE MAXH
DISP:TRAC1:MODE MINH

//-----Performing a sweep and retrieving results-----

//Change sweep count
SENS:SWEEP:COUNT 7
//Single Sweep mode
INIT:CONT OFF
//Switch back to first IQ channel
INST:SEL 'IQ 1';*WAI
//Perform a measurement
INIT:IMM;*OPC?

```

```

//Retrieve results
CALC:MARK:Y?
//Activate Multiview
DISPlay:ATAB ON

//-----Performing a sequence of measurements with the Sequencer-----
//Activate Sequencer
SYSTem:SEQuencer ON
//Start sweep in Sequencer
INITiate:SEQuencer:IMMediate;*OPC?
//Switch into first IQ channel to get results
INST:SEL 'IQ 1';*WAI
CALCulate:MARKer:MAXimum
CALC:MARK:Y?
//Change sweep time in IQ
SENS:SWE:TIME 300us
//Switch to single Sequencer mode
INITiate:SEQuencer:MODE SINGLE
//Sweep all channels once, taking the sweep count in each channel into account
INITiate:SEQuencer:IMMediate;*OPC?
//Set marker to maximum in IQ1 and query result
CALCulate:MARKer:MAXimum
CALC:MARK:Y?
//Switch to second IQ channel and retrieve results
INST:SEL 'IQ 2';*WAI
CALCulate:MARKer:MIN
CALC:MARK:Y?
//Switch to first Spectrum channel
INST:SEL 'Spectrum';*WAI
//Query one of the SEM results
CALCulate:MARKer:FUNCTion:POWer:RESult? CPOWer
//Switch to second Spectrum channel
INST:SEL 'Spectrum 2';*WAI
//Query channel power result
CALCulate:MARKer:FUNCTion:POWer:RESult? ACPower

```

## 9.6 Configuring and Performing Measurements

The following commands are required to configure measurements in a remote environment. The tasks for manual operation are described in [Chapter 8.2, "Measurements and Results"](#), on page 239.

- [Performing Measurements](#).....588
- [Configuring Power Measurements](#).....591
- [Measuring the Channel Power and ACLR](#).....595
- [Measuring the Carrier-to-Noise Ratio](#).....613
- [Measuring the Occupied Bandwidth](#).....614
- [Measuring the Spectrum Emission Mask](#).....615

|                                                                |     |
|----------------------------------------------------------------|-----|
| • Measuring Spurious Emissions.....                            | 645 |
| • Analyzing Statistics (APD, CCDF).....                        | 656 |
| • Measuring the Time Domain Power.....                         | 665 |
| • Measuring the Harmonic Distortion.....                       | 675 |
| • Measuring the Third Order Intercept Point.....               | 678 |
| • Measuring the AM Modulation Depth.....                       | 681 |
| • Remote Commands for EMI Measurements.....                    | 683 |
| • List Evaluations.....                                        | 691 |
| • Measuring the Pulse Power.....                               | 695 |
| • Programming Example: Performing a Basic Frequency Sweep..... | 700 |

## 9.6.1 Performing Measurements

### Useful commands for performing measurements described elsewhere

- `INITiate<n>:ESpectrum` on page 617
- `INITiate<n>:SPURious` on page 645

### Remote commands exclusive for performing measurements:

|                                                  |     |
|--------------------------------------------------|-----|
| <code>ABORt</code> .....                         | 588 |
| <code>INITiate&lt;n&gt;:CONMeas</code> .....     | 589 |
| <code>INITiate&lt;n&gt;:CONTinuous</code> .....  | 589 |
| <code>INITiate&lt;n&gt;:[IMMediate]</code> ..... | 590 |
| <code>[SENSe:]SWEep:COUNT:CURRent?</code> .....  | 591 |

---

### ABORt

This command aborts the measurement in the current channel setup and resets the trigger system.

To prevent overlapping execution of the subsequent command before the measurement has been aborted successfully, use the `*OPC?` or `*WAI` command after `ABOR` and before the next command.

For details see "[Preventing Overlapping Execution](#)" on page 186.

### Note on blocked remote control programs:

If a sequential command cannot be completed, for example because a triggered sweep never receives a trigger, the remote control program will never finish and the remote channel to the R&S FPL1000 is blocked for further commands. In this case, you must interrupt processing on the remote channel first in order to abort the measurement.

To do so, send a "Device Clear" command from the control instrument to the R&S FPL1000 on a parallel channel to clear all currently active remote channels. Depending on the used interface and protocol, send the following commands:

- **Visa:** `viClear()`

Now you can send the `ABORt` command on the remote channel performing the measurement.

|                 |                                                                                                                 |
|-----------------|-----------------------------------------------------------------------------------------------------------------|
| <b>Example:</b> | ABOR; :INIT:IMM<br>Aborts the current measurement and immediately starts a new one.                             |
| <b>Example:</b> | ABOR; *WAI<br>INIT:IMM<br>Aborts the current measurement and starts a new one once abortion has been completed. |
| <b>Usage:</b>   | Event                                                                                                           |

---

### INITiate<n>:CONMeas

This command restarts a (single) measurement that has been stopped (using `ABORT`) or finished in single sweep mode.

The measurement is restarted at the beginning, not where the previous measurement was stopped.

**Suffix:**

<n> irrelevant

**Example:**

```
INIT:CONT OFF
Switches to single sweep mode.
DISP:WIND:TRAC:MODE AVER
Switches on trace averaging.
SWE:COUN 20
Setting the sweep counter to 20 sweeps.
INIT; *WAI
Starts the measurement and waits for the end of the 20 sweeps.
INIT:CONM; *WAI
Continues the measurement (next 20 sweeps) and waits for the end.
Result: Averaging is performed over 40 sweeps.
```

**Manual operation:** See "[Continue Single Sweep](#)" on page 446

---

### INITiate<n>:CONTinuous <State>

This command controls the sweep mode for an individual channel setup.

Note that in single sweep mode, you can synchronize to the end of the measurement with `*OPC`, `*OPC?` or `*WAI`. In continuous sweep mode, synchronization to the end of the measurement is not possible. Thus, it is not recommended that you use continuous sweep mode in remote control, as results like trace data or markers are only valid after a single sweep end synchronization.

For details on synchronization see [Chapter 7.4.1.6, "Command Sequence and Synchronization"](#), on page 185.

**Suffix:**

<n> irrelevant

**Parameters:**

<State> ON | OFF | 0 | 1

|                          |                                                                                                                                                                         |
|--------------------------|-------------------------------------------------------------------------------------------------------------------------------------------------------------------------|
|                          | <b>ON   1</b><br>Continuous sweep                                                                                                                                       |
|                          | <b>OFF   0</b><br>Single sweep                                                                                                                                          |
|                          | *RST: 1                                                                                                                                                                 |
| <State>                  | ON   OFF   0   1                                                                                                                                                        |
|                          | <b>ON   1</b><br>Continuous sweep                                                                                                                                       |
|                          | <b>OFF   0</b><br>Single sweep                                                                                                                                          |
|                          | *RST: 0                                                                                                                                                                 |
| <b>Example:</b>          | INIT:CONT OFF<br>Switches the sweep mode to single sweep.<br>INIT:CONT ON<br>Switches the sweep mode to continuous sweep.                                               |
| <b>Manual operation:</b> | See " <a href="#">Frequency Sweep</a> " on page 240<br>See " <a href="#">Zero Span</a> " on page 240<br>See " <a href="#">Continuous Sweep / Run Cont</a> " on page 446 |

**INITiate<n>[:IMMEDIATE]**

This command starts a (single) new measurement.

With sweep count or average count > 0, this means a restart of the corresponding number of measurements. With trace mode MAXHold, MINHold and AVERage, the previous results are reset on restarting the measurement.

You can synchronize to the end of the measurement with \*OPC, \*OPC? or \*WAI.

For details on synchronization see [Chapter 7.4.1.6, "Command Sequence and Synchronization"](#), on page 185.

**Suffix:**

<n> irrelevant

**Example:** INIT:CONT OFF  
Switches to single sweep mode.  
DISP:WIND:TRAC:MODE AVER  
Switches on trace averaging.  
SWE:COUN 20  
Sets the sweep counter to 20 sweeps.  
INIT;\*WAI  
Starts the measurement and waits for the end of the 20 sweeps.

**Manual operation:** See " [Frequency Sweep](#) " on page 240  
See " [Zero Span](#) " on page 240  
See " [Single Sweep / Run Single](#) " on page 445

**[SENSe:]SWEep:COUNT:CURRent?**

This query returns the current number of started sweeps or measurements. This command is only available if a sweep count value is defined and the instrument is in single sweep mode.

**Return values:**

<CurrentCount>

**Example:**

```
SWE:COUNT 64
Sets sweep count to 64
INIT:CONT OFF
Switches to single sweep mode
INIT
Starts a sweep (without waiting for the sweep end!)
SWE:COUNT:CURR?
Queries the number of started sweeps
```

**Usage:** Query only

## 9.6.2 Configuring Power Measurements

The following commands work for several power measurements.

|                                                        |     |
|--------------------------------------------------------|-----|
| CALCulate<n>:MARKer<m>:FUNCTION:POWER<sb>:MODE.....    | 591 |
| CALCulate<n>:MARKer<m>:FUNCTION:POWER<sb>:RESult?..... | 592 |
| CALCulate<n>:MARKer<m>:FUNCTION:POWER<sb>:SElect.....  | 593 |
| CALCulate<n>:MARKer<m>:FUNCTION:POWER<sb>[:STATe]..... | 594 |
| [SENSe:]POWER:ACHannel:PRESet.....                     | 594 |
| [SENSe:]POWER:ACHannel:PRESet:RLEVel.....              | 595 |
| [SENSe:]POWER:TRACe.....                               | 595 |

---

**CALCulate<n>:MARKer<m>:FUNCTION:POWER<sb>:MODE <Mode>**

This command selects the trace display mode for power measurements.

**Suffix:**

<n>                    [Window](#)  
 <m>                    [Marker](#)  
 <sb>                   irrelevant

**Parameters:**

<Mode>                WRITe | MAXHold

**WRITe**

The power is calculated from the current trace.

**MAXHold**

The power is calculated from the current trace and compared with the previous power value using a maximum algorithm.

**Manual operation:** See " [Power Mode](#) " on page 273

**CALCulate<n>:MARKer<m>:FUNCtion:POWer<sb>:RESult? <Measurement>**

This command queries the results of power measurements.

To get a valid result, you have to perform a complete measurement with synchronization to the end of the measurement before reading out the result. This is only possible for single sweep mode.

See also [INITiate<n>:CONTinuous](#) on page 589.

**Suffix:**

|      |                                                             |
|------|-------------------------------------------------------------|
| <n>  | irrelevant                                                  |
| <m>  | irrelevant                                                  |
| <sb> | Multi-SEM: 1 to 3<br>for all other measurements: irrelevant |

**Parameters:**

&lt;Measurement&gt;

**ACPower | MCACpower**

ACLR measurements (also known as adjacent channel power or multicarrier adjacent channel measurements).

Returns the power for every active transmission and adjacent channel. The order is:

- power of the transmission channels
- power of adjacent channel (lower,upper)
- power of alternate channels (lower,upper)

The unit of the return values depends on the scaling of the y-axis:

- logarithmic scaling returns the power in the current unit
- linear scaling returns the power in W

**CN**

Carrier-to-noise measurements.

Returns the C/N ratio in dB.

**CNO**

Carrier-to-noise measurements.

Returns the C/N ratio referenced to a 1 Hz bandwidth in dBm/Hz.

**CPOWer**

Channel power measurements.

Returns the channel power. The unit of the return values depends on the scaling of the y-axis:

- logarithmic scaling returns the power in the current unit
- linear scaling returns the power in W

For SEM measurements, the return value is the channel power of the reference range.



**PPOWer**

Peak power measurements.

Returns the peak power. The unit of the return values depends on the scaling of the y-axis:

- logarithmic scaling returns the power in the current unit
- linear scaling returns the power in W

For SEM measurements, the return value is the peak power of the reference range.

Note that this result is only available if the power reference type is set to peak power (see [\[SENSe:\]ESpectrum<sb>:RTYPE](#) on page 634).

**OBANdwidth | OBWidth**

Occupied bandwidth.

Returns the occupied bandwidth in Hz.

**COBAndwidth | COBWidth**

<Centroid frequency>,<Frequency offset>

See [Chapter 8.2.5.2, "OBW Results"](#), on page 290

**Manual operation:** See "C/N" on page 287  
See "C/N0" on page 287

**CALCulate<n>:MARKer<m>:FUNction:POWer<sb>:SElect <MeasType>**

This command selects a power measurement and turns the measurement on.

**Suffix:**

|      |            |
|------|------------|
| <n>  | Window     |
| <m>  | Marker     |
| <sb> | irrelevant |

**Parameters:**

<MeasType>

**ACPower | MCACpower**

Adjacent channel leakage ratio (ACLR), also known as adjacent channel power or multicarrier adjacent channel.

The R&S FPL1000 performs the measurement on the trace selected with [\[SENSe:\]POWer:TRACe](#).

**CPOWer**

Channel power measurement with a single carrier.

The R&S FPL1000 performs the measurement on the trace selected with [\[SENSe:\]POWer:TRACe](#).

**OBANdwidth | OBWidth**

Occupied bandwidth measurement.

The R&S FPL1000 performs the measurement on the trace that marker 1 is positioned on.

**CN**

Carrier-to-noise ratio measurement.

**CNO**

Carrier-to-noise ratio measurement referenced to 1 Hz bandwidth

**Manual operation:** See " C/N " on page 287  
See " C/N0 " on page 287

**CALCulate<n>:MARKer<m>:FUNction:POWer<sb>[:STATe] <State>**

This command turns a power measurement on and off.

**Suffix:**

<n> irrelevant  
<m> irrelevant  
<sb> irrelevant

**Parameters:**

<State> ON | OFF | 1 | 0

**ON | 1**

The power measurement selected with `CALCulate<n>:MARKer<m>:FUNction:POWer<sb>:SElect` is activated.

**OFF | 0**

A standard frequency sweep is activated.

\*RST: 0

**Manual operation:** See " C/N " on page 287  
See " C/N0 " on page 287

**[SENSe:]POWer:ACHannel:PRESet <Measurement>**

This command determines the ideal span, bandwidths and detector for the current power measurement.

To get a valid result, you have to perform a complete measurement with synchronization to the end of the measurement before reading out the result. This is only possible for single sweep mode.

See also `INITiate<n>:CONTinuous` on page 589.

**Parameters:**

<Measurement> **ACPower | MCACpower**  
ACLR measurement  
**CPOWer**  
channel power measurement  
**OBANdwidth | OBWidth**  
Occupied bandwidth measurement  
**CN**  
Carrier to noise ratio  
**CNO**  
Carrier to noise ration referenced to a 1 Hz bandwidth

**Manual operation:** See "Optimized Settings ( Adjust Settings )" on page 273  
 See " Adjust Settings " on page 287  
 See " Adjust Settings " on page 292

---

#### [SENSe:]POWer:ACHannel:PRESet:RLEVel

This command determines the ideal reference level for the current measurement.

This automatic routine makes sure that the that the signal power level does not overload the R&S FPL1000 or limit the dynamic range by too small a S/N ratio.

To determine the best reference level, the R&S FPL1000 aborts current measurements and performs a series of test sweeps. After it has finished the test, it continues with the actual measurement.

To get a valid result, you have to perform a complete sweep with synchronization to the sweep end. This is only possible in single sweep mode.

---

#### [SENSe:]POWer:TRACe <TraceNumber>

This command selects the trace channel power measurements are performed on.

For the measurement to work, the corresponding trace has to be active.

##### Parameters:

<TraceNumber> Range: 1 to 6  
 \*RST: 1

**Example:** POW:TRAC 2  
 Assigns the measurement to trace 2.

**Manual operation:** See " Selected Trace " on page 272

### 9.6.3 Measuring the Channel Power and ACLR

All remote control commands specific to channel power or ACLR measurements are described here.



See also [Chapter 9.6.2, "Configuring Power Measurements"](#), on page 591.

- [Managing Measurement Configurations](#)..... 596
- [Configuring the Channels](#).....597
- [Defining Weighting Filters](#)..... 601
- [Selecting the Reference Channel](#)..... 603
- [Checking Limits](#).....604
- [Performing an ACLR Measurement](#).....609
- [Retrieving and Analyzing Measurement Results](#)..... 609
- [Programming Examples for Channel Power Measurements](#)..... 611

### 9.6.3.1 Managing Measurement Configurations

The following commands control measurement configurations for ACLR measurements.

|                                                                  |     |
|------------------------------------------------------------------|-----|
| CALCulate<n>:MARKer<m>:FUNction:POWer<sb>:PRESet.....            | 596 |
| CALCulate<n>:MARKer<m>:FUNction:POWer<sb>:STANdard:CATalog?..... | 596 |
| CALCulate<n>:MARKer<m>:FUNction:POWer<sb>:STANdard:DELeTe.....   | 597 |
| CALCulate<n>:MARKer<m>:FUNction:POWer<sb>:STANdard:SAVE.....     | 597 |

---

#### CALCulate<n>:MARKer<m>:FUNction:POWer<sb>:PRESet <Standard>

This command loads a measurement configuration.

The measurement configuration for power measurements consists of weighting filter, channel bandwidth and spacing, resolution and video bandwidth, detector and sweep time.

**Suffix:**

|      |            |
|------|------------|
| <n>  | Window     |
| <m>  | Marker     |
| <sb> | irrelevant |

**Parameters:**

|            |                                                                                                                                                                                                                           |
|------------|---------------------------------------------------------------------------------------------------------------------------------------------------------------------------------------------------------------------------|
| <Standard> | For more information see <a href="#">Chapter 8.2.3.8, "Reference: Predefined CP/ACLR Standards"</a> , on page 284.<br>If you want to load a customized configuration, the parameter is a string containing the file name. |
|------------|---------------------------------------------------------------------------------------------------------------------------------------------------------------------------------------------------------------------------|

**Manual operation:** See "[Predefined Standards](#)" on page 270  
See "[User Standards](#)" on page 270

---

#### CALCulate<n>:MARKer<m>:FUNction:POWer<sb>:STANdard:CATalog?

This command queries all files containing ACLR standards.

**Suffix:**

|      |                                                             |
|------|-------------------------------------------------------------|
| <n>  | Window                                                      |
| <m>  | Marker                                                      |
| <sb> | Multi-SEM: 1 to 3<br>for all other measurements: irrelevant |

**Return values:**

|             |                         |
|-------------|-------------------------|
| <Standards> | List of standard files. |
|-------------|-------------------------|

**Usage:** Query only

**Manual operation:** See "[User Standards](#)" on page 270

---

**CALCulate<n>:MARKer<m>:FUNction:POWer<sb>:STANdard:DELeTe**  
 <Standard>

This command deletes a file containing an ACLR standard.

**Suffix:**

|      |            |
|------|------------|
| <n>  | Window     |
| <m>  | Marker     |
| <sb> | irrelevant |

**Parameters:**

<Standard> String containing the file name of the standard.

**Manual operation:** See " [User Standards](#) " on page 270

---

**CALCulate<n>:MARKer<m>:FUNction:POWer<sb>:STANdard:SAVE** <Standard>

This command saves the current ACLR measurement configuration as a new ACLR standard.

The measurement configuration for power measurements consists of weighting filter, channel bandwidth and spacing, resolution and video bandwidth, detector and sweep time.

**Suffix:**

|      |            |
|------|------------|
| <n>  | Window     |
| <m>  | Marker     |
| <sb> | irrelevant |

**Parameters:**

<Standard> String containing the file name. The file format is xml.

**Manual operation:** See " [User Standards](#) " on page 270

### 9.6.3.2 Configuring the Channels

The following commands configure channels for channel power and ACLR measurements.

|                                                     |     |
|-----------------------------------------------------|-----|
| [SENSe:]POWer:ACHannel:ACPairs.....                 | 598 |
| [SENSe:]POWer:ACHannel:BWIDth:ACHannel.....         | 598 |
| [SENSe:]POWer:ACHannel:BANDwidth:ACHannel.....      | 598 |
| [SENSe:]POWer:ACHannel:BWIDth:ALternate<ch>.....    | 598 |
| [SENSe:]POWer:ACHannel:BANDwidth:ALternate<ch>..... | 598 |
| [SENSe:]POWer:ACHannel:BWIDth[:CHANnel<ch>].....    | 598 |
| [SENSe:]POWer:ACHannel:BANDwidth[:CHANnel<ch>]..... | 598 |
| [SENSe:]POWer:ACHannel:NAME:ACHannel.....           | 599 |
| [SENSe:]POWer:ACHannel:NAME:ALternate<ch>.....      | 599 |
| [SENSe:]POWer:ACHannel:NAME:CHANnel<ch>.....        | 599 |
| [SENSe:]POWer:ACHannel:SPACing[:ACHannel].....      | 599 |

|                                                   |     |
|---------------------------------------------------|-----|
| [SENSe:]POWer:ACHannel:SPACing:ALTErnate<ch>..... | 600 |
| [SENSe:]POWer:ACHannel:SPACing:CHANnel<ch>.....   | 600 |
| [SENSe:]POWer:ACHannel:TXCHannel:COUnT.....       | 600 |

---

**[SENSe:]POWer:ACHannel:ACPairs <ChannelPairs>**

This command defines the number of pairs of adjacent and alternate channels.

**Parameters:**

<ChannelPairs>      Range:      0 to 12  
                          \*RST:        1

**Manual operation:**    See " [Number of channels: Tx , Adj](#) " on page 271

---

**[SENSe:]POWer:ACHannel:BWIDth:ACHannel <Bandwidth>**
**[SENSe:]POWer:ACHannel:BANDwidth:ACHannel <Bandwidth>**

This command defines the channel bandwidth of the adjacent channels.

**Parameters:**

<Bandwidth>          Range:        100 Hz to 1000 MHz  
                          \*RST:        14 kHz  
                          Default unit: Hz

**Manual operation:**    See " [Channel Bandwidth](#) " on page 274

---

**[SENSe:]POWer:ACHannel:BWIDth:ALTErnate<ch> <Bandwidth>**
**[SENSe:]POWer:ACHannel:BANDwidth:ALTErnate<ch> <Bandwidth>**

This command defines the channel bandwidth of the alternate channels.

If you set the channel bandwidth for the first alternate channel, the R&S FPL1000 sets the bandwidth of the other alternate channels to the same value, but not the other way round. The command works hierarchically: to set a bandwidth of the 3rd and 4th channel, you have to set the bandwidth of the 3rd channel first.

**Suffix:**

<ch>                    1..n  
                          Alternate channel number

**Parameters:**

<Bandwidth>          Range:        100 Hz to 1000 MHz  
                          \*RST:        14 kHz  
                          Default unit: Hz

**Manual operation:**    See " [Channel Bandwidth](#) " on page 274

---

**[SENSe:]POWer:ACHannel:BWIDth[:CHANnel<ch>] <Bandwidth>**
**[SENSe:]POWer:ACHannel:BANDwidth[:CHANnel<ch>] <Bandwidth>**

This command defines the channel bandwidth of the transmission channels.

**Suffix:**

<ch> 1..n  
Tx channel number

**Parameters:**

<Bandwidth> Range: 100 Hz to 1000 MHz  
\*RST: 14 kHz  
Default unit: Hz

**Manual operation:** See " [Channel Bandwidth](#) " on page 274  
See " [Channel Bandwidth](#) " on page 287  
See " [Channel Bandwidth](#) " on page 292

**[SENSe:]POWer:ACHannel:NAME:ACHannel <Name>**

This command defines a name for the adjacent channel.

**Parameters:**

<Name> String containing the name of the channel  
\*RST: ADJ

**Manual operation:** See " [Channel Names](#) " on page 276

**[SENSe:]POWer:ACHannel:NAME:ALTErnate<ch> <Name>**

This command defines a name for an alternate channel.

**Suffix:**

<ch> 1..n  
Alternate channel number

**Parameters:**

<Name> String containing the name of the channel  
\*RST: ALT<1...11>

**Manual operation:** See " [Channel Names](#) " on page 276

**[SENSe:]POWer:ACHannel:NAME:CHANnel<ch> <Name>**

This command defines a name for a transmission channel.

**Suffix:**

<ch> 1..n  
Tx channel number

**Parameters:**

<Name> String containing the name of the channel  
\*RST: TX<1...12>

**Manual operation:** See " [Channel Names](#) " on page 276

**[SENSe:]POWer:ACHannel:SPACing[:ACHannel] <Spacing>**

This command defines the distance from transmission channel to adjacent channel.

**Parameters:**

<Spacing>            Range:     100 Hz to 2000 MHz  
                          \*RST:     14 kHz  
                          Default unit: Hz

**Manual operation:** See " [Channel Spacings](#) " on page 275

**[SENSe:]POWer:ACHannel:SPACing:ALternate<ch>** <Spacing>

This command defines the distance from transmission channel to alternate channels.

If you set the channel spacing for the first alternate channel, the R&S FPL1000 adjusts the spacing of alternate channels of a lower order, but not the other way round. The command works hierarchically: to set a distance from the transmission channel to the 2nd and 3rd alternate channel, you have to define a spacing for the 2nd alternate channel first.

**Suffix:**

<ch>                    1..n  
                          Alternate channel number

**Parameters:**

<Spacing>            Range:     100 Hz to 2000 MHz  
                          \*RST:     40 kHz (ALT1), 60 kHz (ALT2), 80 kHz (ALT3), ...  
                          Default unit: Hz

**Manual operation:** See " [Channel Spacings](#) " on page 275

**[SENSe:]POWer:ACHannel:SPACing:CHANnel<ch>** <Spacing>

This command defines the distance between transmission channels.

If you set the channel spacing for a transmission channel, the R&S FPL1000 sets the spacing of the lower transmission channels to the same value, but not the other way round. The command works hierarchically: to set a distance between the 2nd and 3rd and 3rd and 4th channel, you have to set the spacing between the 2nd and 3rd channel first.

**Suffix:**

<ch>                    1..n  
                          Tx channel number

**Parameters:**

<Spacing>            Range:     14 kHz to 2000 MHz  
                          \*RST:     20 kHz  
                          Default unit: Hz

**Manual operation:** See " [Channel Spacings](#) " on page 275

**[SENSe:]POWer:ACHannel:TXChannel:COUNT** <Number>

This command defines the number of transmission channels.

The command works for measurements in the frequency domain.



**Parameters:**

<Number>                   Range:     1 to 18  
                               \*RST:       1

**Manual operation:**   See " [Number of channels: Tx , Adj](#) " on page 271

**9.6.3.3 Defining Weighting Filters**

The following commands define weighting filters for ACLR measurements.

|                                                          |     |
|----------------------------------------------------------|-----|
| [SENSe:]POWer:ACHannel:FILTer:ALPHa:ACHannel.....        | 601 |
| [SENSe:]POWer:ACHannel:FILTer:ALPHa[:ALL].....           | 601 |
| [SENSe:]POWer:ACHannel:FILTer:ALPHa:ALTErnate<ch>.....   | 601 |
| [SENSe:]POWer:ACHannel:FILTer:ALPHa:CHANnel<ch>.....     | 602 |
| [SENSe:]POWer:ACHannel:FILTer[:STATE]:ACHannel.....      | 602 |
| [SENSe:]POWer:ACHannel:FILTer[:STATE][:ALL].....         | 602 |
| [SENSe:]POWer:ACHannel:FILTer[:STATE]:ALTErnate<ch>..... | 602 |
| [SENSe:]POWer:ACHannel:FILTer[:STATE]:CHANnel<ch>.....   | 602 |

---

**[SENSe:]POWer:ACHannel:FILTer:ALPHa:ACHannel <Alpha>**

This command defines the roll-off factor for the adjacent channel weighting filter.

**Parameters:**

<Alpha>                   Roll-off factor  
                               Range:     0 to 1  
                               \*RST:       0.22

**Manual operation:**   See " [Weighting Filters](#) " on page 276

---

**[SENSe:]POWer:ACHannel:FILTer:ALPHa[:ALL] <Value>**

This command defines the alpha value for the weighting filter for all channels.

**Parameters:**

<Value>                   \*RST:       0.22

**Example:**               POW:ACH:FILT:ALPH:ALL 0.35

---

**[SENSe:]POWer:ACHannel:FILTer:ALPHa:ALTErnate<ch> <Alpha>**

This command defines the roll-off factor for the alternate channel weighting filter.

**Suffix:**

<ch>                       1..n  
                               Alternate channel number

**Parameters:**

<Alpha>                   Roll-off factor  
                               Range:     0 to 1  
                               \*RST:       0.22

**Manual operation:**   See " [Weighting Filters](#) " on page 276

---

**[SENSe:]POWer:ACHannel:FILTer:ALPHA:CHANnel<ch> <Alpha>**

This command defines the roll-off factor for the transmission channel weighting filter.

**Suffix:**

<ch>                    1..n  
Tx channel number

**Parameters:**

<Alpha>                Roll-off factor  
Range:                0 to 1  
\*RST:                 0.22

**Manual operation:** See " [Weighting Filters](#) " on page 276

---

**[SENSe:]POWer:ACHannel:FILTer[:STATe]:ACHannel <State>**

This command turns the weighting filter for the adjacent channel on and off.

**Parameters:**

<State>                ON | OFF | 1 | 0  
\*RST:                 0

**Manual operation:** See " [Weighting Filters](#) " on page 276

---

**[SENSe:]POWer:ACHannel:FILTer[:STATe][:ALL] <State>**

This command turns the weighting filters for all channels on and off.

**Parameters:**

<State>                ON | OFF | 1 | 0  
\*RST:                 0

---

**[SENSe:]POWer:ACHannel:FILTer[:STATe]:ALternate<ch> <State>**

This command turns the weighting filter for an alternate channel on and off.

**Suffix:**

<ch>                    1..n  
Alternate channel number

**Parameters:**

<State>                ON | OFF | 1 | 0  
\*RST:                 0

**Manual operation:** See " [Weighting Filters](#) " on page 276

---

**[SENSe:]POWer:ACHannel:FILTer[:STATe]:CHANnel<ch> <State>**

This command turns the weighting filter for a transmission channel on and off.

**Suffix:**

<ch>                    1..n  
Tx channel number

**Parameters:**

<State> ON | OFF | 1 | 0  
 \*RST: 0

**Manual operation:** See " [Weighting Filters](#) " on page 276

**9.6.3.4 Selecting the Reference Channel**

The following commands define the reference channel for relative ACLR measurements.

|                                                        |     |
|--------------------------------------------------------|-----|
| [SENSe:]POWer:ACHannel:REFerence:AUTO ONCE.....        | 603 |
| [SENSe:]POWer:ACHannel:REFerence:TXCHannel:AUTO.....   | 603 |
| [SENSe:]POWer:ACHannel:REFerence:TXCHannel:MANual..... | 603 |

**[SENSe:]POWer:ACHannel:REFerence:AUTO ONCE**

**Usage:** Event

**Manual operation:** See " [Setting a fixed reference for Channel Power measurements \( Set CP Reference \)](#) " on page 273

**[SENSe:]POWer:ACHannel:REFerence:TXCHannel:AUTO <RefChannel>**

This command selects the reference channel for relative measurements.

You need at least one channel for the command to work.

**Parameters:**

<RefChannel> MINimum | MAXimum | LHIGhest

**MINimum**

Transmission channel with the lowest power

**MAXimum**

Transmission channel with the highest power

**LHIGhest**

Lowest transmission channel for lower adjacent channels and highest transmission channel for upper adjacent channels

**Example:**

POW:ACH:REF:TXCH:AUTO MAX

Selects the channel with the peak power as reference channel.

**Manual operation:** See " [Reference Channel](#) " on page 272

**[SENSe:]POWer:ACHannel:REFerence:TXCHannel:MANual <ChannelNumber>**

This command defines a reference channel for relative ACLR measurements.

You need at least one channel for the command to work.

**Parameters:**

<ChannelNumber> Range: 1 to 18  
 \*RST: 1

**Manual operation:** See "Reference Channel" on page 272

### 9.6.3.5 Checking Limits

The following commands configure and query limit checks for channel power and ACLR measurements.



The results of the power limit checks are also indicated in the `STAT:QUES:ACPL` status registry (see "STATUS:QUESTIONABLE:ACPLimit Register" on page 195).

|                                                                                                    |     |
|----------------------------------------------------------------------------------------------------|-----|
| <code>CALCulate&lt;n&gt;:LIMit&lt;li&gt;:ACPowEr:ACHannel:ABSolute</code> .....                    | 604 |
| <code>CALCulate&lt;n&gt;:LIMit&lt;li&gt;:ACPowEr:ACHannel:ABSolute:STATe</code> .....              | 604 |
| <code>CALCulate&lt;n&gt;:LIMit&lt;li&gt;:ACPowEr:ACHannel[:RELative]</code> .....                  | 605 |
| <code>CALCulate&lt;n&gt;:LIMit&lt;li&gt;:ACPowEr:ACHannel:RESult?</code> .....                     | 605 |
| <code>CALCulate&lt;n&gt;:LIMit&lt;li&gt;:ACPowEr:ACHannel[:RELative]:STATe</code> .....            | 606 |
| <code>CALCulate&lt;n&gt;:LIMit&lt;li&gt;:ACPowEr:ALTernate&lt;ch&gt;:ABSolute</code> .....         | 606 |
| <code>CALCulate&lt;n&gt;:LIMit&lt;li&gt;:ACPowEr:ALTernate&lt;ch&gt;:ABSolute:STATe</code> .....   | 607 |
| <code>CALCulate&lt;n&gt;:LIMit&lt;li&gt;:ACPowEr:ALTernate&lt;ch&gt;[:RELative]</code> .....       | 607 |
| <code>CALCulate&lt;n&gt;:LIMit&lt;li&gt;:ACPowEr:ALTernate&lt;ch&gt;:RESult?</code> .....          | 608 |
| <code>CALCulate&lt;n&gt;:LIMit&lt;li&gt;:ACPowEr:ALTernate&lt;ch&gt;[:RELative]:STATe</code> ..... | 608 |
| <code>CALCulate&lt;n&gt;:LIMit&lt;li&gt;:ACPowEr[:STATe]</code> .....                              | 609 |

**`CALCulate<n>:LIMit<li>:ACPowEr:ACHannel:ABSolute` <LowerLimit>[, <UpperLimit>]**

This command defines the absolute limit of the adjacent channels.

If you have defined an absolute limit as well as a relative limit, the R&S FPL1000 uses the lower value for the limit check.

**Suffix:**

<n> irrelevant

<li> irrelevant

**Parameters:**

<LowerLimit> The limit of the lower adjacent channel.

Range: -200 dBm to 200 dBm

\*RST: -200 dBm

Default unit: dBm

<UpperLimit> The limit of the upper adjacent channel.

Range: -200 dBm to 200 dBm

\*RST: -200 dBm

Default unit: dBm

**Manual operation:** See "Limit Check" on page 275

**`CALCulate<n>:LIMit<li>:ACPowEr:ACHannel:ABSolute:STATe`**

This command turns the absolute limit check for the adjacent channels on and off.

You have to activate the general ACLR limit check before using this command with `CALCulate<n>:LIMit<li>:ACPowEr[:STATe]`.

**Suffix:**

<n> irrelevant

<li> irrelevant

**Manual operation:** See " [Limit Check](#) " on page 275

`CALCulate<n>:LIMit<li>:ACPowEr:ACHannel[:RELative] <LowerLimit>[, <UpperLimit>]`

This command defines the relative limit of the adjacent channels. The reference value for the relative limit is the measured channel power.

If you have defined an absolute limit as well as a relative limit, the R&S FPL1000 uses the lower value for the limit check.

**Suffix:**

<n> irrelevant

<li> irrelevant

**Parameters:**

<LowerLimit> The limit of the lower adjacent channel.

Range: 0 dB to 100 dB

\*RST: 0 dB

Default unit: dB

<UpperLimit> The limit of the upper adjacent channel.

Range: 0 dB to 100 dB

\*RST: 0 dB

Default unit: dB

**Manual operation:** See " [Limit Check](#) " on page 275

`CALCulate<n>:LIMit<li>:ACPowEr:ACHannel:RESult?`

This command queries the state of the limit check for the adjacent channels in an ACLR measurement.

To get a valid result, you have to perform a complete measurement with synchronization to the end of the measurement before reading out the result. This is only possible for single sweep mode.

See also `INITiate<n>:CONTinuous` on page 589.

**Suffix:**

<n> irrelevant

<li> irrelevant

**Return values:**

<LowerACH> text value

The state of the limit check for the lower adjacent channels.

**PASSED**

Limit check has passed.

**FAIL**

Limit check has failed.

&lt;UpperACH&gt;

text value

The state of the limit check for the upper adjacent channels.

**PASSED**

Limit check has passed.

**FAIL**

Limit check has failed.

**Example:**

```
INIT:IMM;*WAI;
CALC:LIM:ACP:ACH:RES?
PASSED,PASSED
```

**Usage:**

Query only

**Manual operation:** See " [Limit Check](#) " on page 275**CALCulate<n>:LIMit<li>:ACPpower:ACHannel[:RELative]:STATe**

This command turns the relative limit check for the adjacent channels on and off.

You have to activate the general ACLR limit check before using this command with [CALCulate<n>:LIMit<li>:ACPpower\[:STATe\]](#).**Suffix:**

&lt;n&gt; irrelevant

&lt;li&gt; irrelevant

**Parameters:**

&lt;State&gt; ON | OFF | 1 | 0

Relative limit check for lower adjacent channel

\*RST: 0

**Manual operation:** See " [Limit Check](#) " on page 275**CALCulate<n>:LIMit<li>:ACPpower:ALternate<ch>:ABSolute <LowerLimit>[, <UpperLimit>]**

This command defines the absolute limit of the alternate channels.

If you have defined an absolute limit as well as a relative limit, the R&amp;S FPL1000 uses the lower value for the limit check.

**Suffix:**

&lt;n&gt; irrelevant

&lt;li&gt; irrelevant

<ch> 1..n  
Alternate channel number

**Parameters:**

|              |                                                                                                               |
|--------------|---------------------------------------------------------------------------------------------------------------|
| <LowerLimit> | The limit of the lower adjacent channel.<br>Range: -200 dBm to 200 dBm<br>*RST: -200 dBm<br>Default unit: dBm |
| <UpperLimit> | The limit of the upper adjacent channel.<br>Range: -200 dBm to 200 dBm<br>*RST: -200 dBm<br>Default unit: dBm |

**Manual operation:** See " [Limit Check](#) " on page 275

**CALCulate<n>:LIMit<li>:ACPpower:ALternate<ch>:ABSolute:STATe**

This command turns the absolute limit check for the alternate channels on and off.

You have to activate the general ACLR limit check before using this command with [CALCulate<n>:LIMit<li>:ACPpower\[:STATe\]](#).

**Suffix:**

|      |                                  |
|------|----------------------------------|
| <n>  | irrelevant                       |
| <li> | irrelevant                       |
| <ch> | 1..n<br>Alternate channel number |

**Manual operation:** See " [Limit Check](#) " on page 275

**CALCulate<n>:LIMit<li>:ACPpower:ALternate<ch>[:RELative] <LowerLimit>[, <UpperLimit>]**

This command defines the relative limit of the alternate channels. The reference value for the relative limit is the measured channel power.

If you have defined an absolute limit as well as a relative limit, the R&S FPL1000 uses the lower value for the limit check.

**Suffix:**

|      |                                  |
|------|----------------------------------|
| <n>  | irrelevant                       |
| <li> | irrelevant                       |
| <ch> | 1..n<br>Alternate channel number |

**Parameters:**

|              |                                                                                                      |
|--------------|------------------------------------------------------------------------------------------------------|
| <LowerLimit> | The limit of the lower alternate channel.<br>Range: 0 dB to 100 dB<br>*RST: 0 dB<br>Default unit: dB |
|--------------|------------------------------------------------------------------------------------------------------|

<UpperLimit>      The limit of the upper alternate channel.  
 Range:      0 dB to 100 dB  
 \*RST:      0 dB  
 Default unit: dB

**Manual operation:** See " [Limit Check](#) " on page 275

### **CALCulate<n>:LIMit<li>:ACPpower:ALternate<ch>:RESult?**

This command queries the state of the limit check for the adjacent or alternate channels in an ACLR measurement.

To get a valid result, you have to perform a complete measurement with synchronization to the end of the measurement before reading out the result. This is only possible for single sweep mode.

See also [INITiate<n>:CONTinuous](#) on page 589.

#### **Suffix:**

<n>                    irrelevant  
 <li>                   irrelevant  
 <ch>                  Alternate channel number

#### **Return values:**

<LowerChan>      text value  
 The state of the limit check for the lower alternate or adjacent channels.

#### **PASSED**

Limit check has passed.

#### **FAIL**

Limit check has failed.

<UpperChan>      text value  
 The state of the limit check for the upper alternate or adjacent channels.

#### **PASSED**

Limit check has passed.

#### **FAIL**

Limit check has failed.

**Example:**            INIT:IMM;\*WAI;  
                           CALC:LIM:ACP:ACH:RES?  
                           PASSED,PASSED

**Usage:**              Query only

### **CALCulate<n>:LIMit<li>:ACPpower:ALternate<ch>[:RELative]:STATe**

This command turns the relative limit check for the alternate channels on and off.



You have to activate the general ACLR limit check before using this command with `CALCulate<n>:LIMit<li>:ACPowEr[:STATe]`.

**Suffix:**

|      |                                  |
|------|----------------------------------|
| <n>  | irrelevant                       |
| <li> | irrelevant                       |
| <ch> | 1..n<br>Alternate channel number |

**Manual operation:** See " [Limit Check](#) " on page 275

**CALCulate<n>:LIMit<li>:ACPowEr[:STATe] <State>**

This command turns the limit check for ACLR measurements on and off.

**Suffix:**

|      |            |
|------|------------|
| <n>  | irrelevant |
| <li> | irrelevant |

**Parameters:**

|         |                  |
|---------|------------------|
| <State> | ON   OFF   1   0 |
| *RST:   | 0                |

**Manual operation:** See " [Limit Check](#) " on page 275

**9.6.3.6 Performing an ACLR Measurement**

The following commands are required to perform an ACLR measurement:

- `CALC:MARK:FUNC:POW:SEL ACP`, see `CALCulate<n>:MARKer<m>:FUNction:POWer<sb>:SElect` on page 593
- `CALCulate<n>:MARKer<m>:FUNction:POWer<sb>[:STATe]` on page 594
- `INITiate<n>[:IMMediate]` on page 590

**9.6.3.7 Retrieving and Analyzing Measurement Results**

The following commands retrieve and analyze measurement results for ACLR measurements.

**Useful commands for channel power measurements described elsewhere**

- `CALCulate<n>:MARKer<m>:FUNction:POWer<sb>:RESult?` on page 592
- `TRACe<n>[:DATA]` on page 776
- `CALCulate<n>:LIMit<li>:ACPowEr:ACHannel:RESult?` on page 605
- `CALCulate<n>:LIMit<li>:ACPowEr:ALternate<ch>:RESult?` on page 608

**Remote commands exclusive to channel power measurements**

|                                                                                           |     |
|-------------------------------------------------------------------------------------------|-----|
| <code>CALCulate&lt;n&gt;:MARKer&lt;m&gt;:FUNction:POWer&lt;sb&gt;:RESult:PHZ</code> ..... | 610 |
| <code>[SENSe:]POWer:ACHannel:MODE</code> .....                                            | 610 |

**CALCulate<n>:MARKer<m>:FUNction:POWer<sb>:RESult:PHZ <State>**

This command selects the way the R&S FPL1000 returns results for power measurements.

You can query results with `CALCulate<n>:MARKer<m>:FUNction:POWer<sb>:RESult?`.

**Suffix:**

|      |            |
|------|------------|
| <n>  | Window     |
| <m>  | Marker     |
| <sb> | irrelevant |

**Parameters:**

|         |                                                  |
|---------|--------------------------------------------------|
| <State> | ON   OFF   1   0                                 |
|         | <b>ON   1</b><br>Channel power density in dBm/Hz |
|         | <b>OFF   0</b><br>Channel power in dBm           |
|         | *RST: 0                                          |

**Example:**

`CALC:MARK:FUNC:POW:RES:PHZ ON`  
Output of results referred to the channel bandwidth.

**Manual operation:** See "[Channel power level and density \( Power Unit \)](#)" on page 272

**[SENSe:]POWer:ACHannel:MODE <Mode>**

This command selects the way the R&S FPL1000 displays the power of adjacent channels.

You need at least one adjacent channel for the command to work.

**Parameters:**

|        |                                                                                                               |
|--------|---------------------------------------------------------------------------------------------------------------|
| <Mode> | ABSolute   RELative                                                                                           |
|        | <b>ABSolute</b><br>Shows the absolute power of all channels                                                   |
|        | <b>RELative</b><br>Shows the power of adjacent and alternate channels in relation to the transmission channel |
|        | *RST: RELative                                                                                                |

**Manual operation:** See "[Absolute and Relative Values \(ACLR Mode\)](#)" on page 272

### 9.6.3.8 Programming Examples for Channel Power Measurements

The following programming examples are meant to demonstrate the most important commands to perform channel power measurements in a remote environment.

- [Example: Configuring and Performing an ACLR Measurement](#).....611

#### Example: Configuring and Performing an ACLR Measurement

In this example we will configure and perform an adjacent-channel power measurement. Note that this example is primarily meant to demonstrate the remote control commands, it does not necessarily reflect a useful measurement task. For most common measurement standards, the R&S FPL1000 performs the measurement optimally with the predefined settings, without further configuration.

```
//-----Preparing the measurement -----
//Reset the instrument
*RST

//-----Preparing the measurement-----

//Activate adjacent-channel power measurement.
CALC:MARK:FUNC:POW:SEL ACP
//Select the user standard "GSM"
CALC:MARK:FUNC:POW:PRES GSM

//-----Setting Up Channels-----
//Create one transmission channel.
POW:ACH:TXCH:COUN 1
//Name the first transmission channel 'TX Channel'.
POW:ACH:NAME:CHAN1 'TX Channel'
//Create two adjacent channels - one adjacent channel and one alternate channel.
POW:ACH:ACP 2
//Name the adjacent channel 'ABC'
POW:ACH:NAME:ACH 'ABC'
//Name the first alternate channel 'XYZ'.
POW:ACH:NAME:ALT1 'XYZ'
//Define a bandwidth of 30 kHz for the transmission channel.
POW:ACH:BWID:CHAN1 30kHz
//Define a bandwidth of 30 kHz for the adjacent channel.
POW:ACH:BWID:ACH 30kHz
//Define a bandwidth of 30 kHz for the first alternate channel.
POW:ACH:BWID:ALT1 30kHz
//Define a distance of 33 kHz from the center of the transmission channel to the
//center of the adjacent channel.
//Also adjust the distance to the alternate channels (66 kHz).
POW:ACH:SPAC 33kHz
//Define a distance of 100 kHz from the center of the transmission channel to the
//center of the first alternate channel.
POW:ACH:SPAC:ALT1 100kHz

//-----Selecting a Reference Channel--
```

## Configuring and Performing Measurements

```

//Select relative display of the channel power.
POW:ACH:MODE REL
//Define transmission channel 1 as the reference channel.
POW:ACH:REF:TXCH:MAN 1

//-----Saving the settings as a user standard-----
//Save the user standard with the name "my_aclr_standard".
//Weighting filters can only be defined for user-defined standards.
CALC:MARK:FUNC:POW:STAN:SAVE 'my_aclr_standard'

//-----Defining Weighting Filters-----
//Define a roll-off factor of 0.35 for the weighting filter of the first
//transmission channel.
POW:ACH:FILT:ALPH:CHAN1 0.35
//Turn the weighting filter for the first transmission channel on.
POW:ACH:FILT:CHAN1 ON
//Define a roll-off factor of 0.35 for the weighting filter of the adjacent
//channel.
POW:ACH:FILT:ALPH:ACH 0.35
//Turn the weighting filter for the adjacent channel on.
POW:ACH:FILT:ACH ON
//Define a roll-off factor of 0.35 for the weighting filter of the first
//alternate channel.
POW:ACH:FILT:ALPH:ALT1 0.35
//Turn the weighting filter for the first alternate channel on.
POW:ACH:FILT:ALT1 ON

//-----Working with Limits-----
//Define a relative limit of 30 dB below the power of the reference channel
//for both adjacent channels.
CALC:LIM:ACP:ACH 30DB,30DB
//Define a relative limit of 25 dB below the power of the reference channel
//for the first alternate channels.
CALC:LIM:ACP:ALT1 25DB,25DB
//Define an absolute limit of -35 dBm for both adjacent channels.
CALC:LIM:ACP:ACH:ABS -35DBM,-35DBM
//Turn the ACLR limit check on.
CALC:LIM:ACP ON
//Turn the relative limit check for adjacent channels on.
CALC:LIM:ACP:ACH:STAT ON
//Turn the absolute limit check for adjacent channels on.
CALC:LIM:ACP:ACH:ABS:STAT ON
//Turn the absolute limit check for the first alternate channel on.
CALC:LIM:ACP:ALT1:ABS:STAT ON

//-----Performing the Measurement-----
//Determine the ideal ACLR measurement configuration.
POW:ACH:PRES ACP;*WAI
//Determine the ideal reference level for the measurement.
POW:ACH:PRES:RLEV;*WAI

```

```

//Initiate a new measurement and waits until the sweep has finished.
INIT;*WAI

//-----Limit Check-----
//Query the results of the limit check for the adjacent channels.
CALC:LIM:ACP:ACH:RES?
//Query the results of the limit check for the first alternate channels.
CALC:LIM:ACP:ALT1:RES?

//-----Retrieving Results-----
//Query the results for the ACLR measurement.
CALC:MARK:FUNC:POW:RES? ACP

```

### 9.6.4 Measuring the Carrier-to-Noise Ratio

The following commands are necessary to perform carrier-to-noise measurements.

- `CALC:MARK:FUNC:POW:SEL CN | CN0`, see [CALCulate<n>:MARKer<m>:FUNCTION:Power<sb>:SElect](#)
- `CALCulate<n>:MARKer<m>:FUNCTION:Power<sb>[:STATE]`
- `CALCulate<n>:MARKer<m>:FUNCTION:Power<sb>:RESult?`
- `[SENSe:]Power:ACHannel:BANDwidth[:CHANnel<ch>]`
- `[SENSe:]Power:ACHannel:PRESet`

#### Programming example: Measuring the carrier-to-noise ratio

This programming example demonstrates how to perform a Carrier-to-noise measurement in a remote environment.

```

//-----Preparing the measurement-----
*RST
//Reset the instrument
FREQ:CENt 800MHz
//Sets the center frequency to the carrier frequency of 800 MHz.
CALC:MARK:FUNC:POW:SEL CN
//Activates carrier-to-noise ratio measurement.
POW:ACH:PREs CN
//Optimizes the instrument settings according to the channel bandwidth.
POW:ACH:PREs:RLEV
//Determines the ideal reference level for the measurement.

//-----Performing the Measurement-----
INIT:CONt OFF
//Selects single sweep mode.
INIT;*WAI
//Initiates a new measurement and waits until the sweep has finished.

// Now turn off the carrier signal and repeat the measurement:
INIT;*WAI

```

```
//Initiates a new measurement and waits until the sweep has finished.

//-----Retrieving Results-----
CALC:MARK:FUNC:POW:RES? CN
//Returns the carrier-to-noise ratio.
```

## 9.6.5 Measuring the Occupied Bandwidth

All remote control commands specific to occupied bandwidth measurements are described here.

- [Configuring the Measurement](#).....614
- [Programming Example: OBW Measurement](#).....615

### 9.6.5.1 Configuring the Measurement

The following commands configure measurements of the occupied bandwidth.

#### Useful commands for occupied bandwidth measurements described elsewhere

Configuring the channel:

- `[SENSe:]POWer:ACHannel:BANDwidth[:CHANnel<ch>]`
- `[SENSe:]POWer:ACHannel:PRESet`
- `[SENSe:]POWer:ACHannel:PRESet:RLEVel`

Defining search limits:

- `CALCulate<n>:MARKer<m>:X:SLIMits[:STATe]` on page 793
- `CALCulate<n>:MARKer<m>:X:SLIMits:LEFT` on page 793
- `CALCulate<n>:MARKer<m>:X:SLIMits:RIGHT` on page 794

Performing the measurement:

- `CALCulate<n>:MARKer<m>:FUNction:POWer<sb>:SElect` on page 593
- `CALCulate<n>:MARKer<m>:FUNction:POWer<sb>[:STATe]` on page 594

Retrieving results:

- `CALCulate<n>:MARKer<m>:FUNction:POWer<sb>:RESult?` on page 592

#### Remote commands exclusive to occupied bandwidth measurements:

- `[SENSe:]POWer:BWIDth`..... 614
- `[SENSe:]POWer:BANDwidth`..... 614

---

`[SENSe:]POWer:BWIDth <Percentage>`  
`[SENSe:]POWer:BANDwidth <Percentage>`

This command selects the percentage of the total power that defines the occupied bandwidth.

**Parameters:**

<Percentage>            Range:        10 PCT to 99.9 PCT  
                              \*RST:        99 PCT  
                              Default unit: PCT

**Example:**                POW:BAND 95PCT

**Manual operation:**    See " % Power Bandwidth " on page 291

### 9.6.5.2 Programming Example: OBW Measurement

This programming example demonstrates the measurement example described in [Chapter 8.2.5.5, "Measurement Example"](#), on page 294 in a remote environment.

```
//-----Preparing the measurement -----
//Reset the instrument
*RST

//-----Configuring the Measurement-----
//Set the center frequency to 800 MHz.
FREQ:CENT 800MHz
//Set the reference level to -10 dBm.
DISP:TRAC:Y:RLEV -10dBm
//Activate occupied bandwidth measurement.
CALC:MARK:FUNC:POW:SEL OBW
//Set the percentage of power to 99%.
POW:BWID 99PCT
//Set the channel bandwidth to 21 kHz.
POW:ACH:BAND 21kHz
//Optimize the instrument settings according to the channel bandwidth.
POW:ACH:PRES OBW
//Determine the ideal reference level for the measurement.
POW:ACH:PRES:RLEV
//Set the trace detector to positive peak.
DET APE

//-----Performing the Measurement-----
//Select single sweep mode.INIT:CONT OFF

//Initiate a new measurement and waits until the sweep has finished.
INIT;*WAI

//-----Retrieving Results-----
//Return the occupied bandwidth.
CALC:MARK:FUNC:POW:RES? OBW
```

## 9.6.6 Measuring the Spectrum Emission Mask

All remote control commands specific to spectrum emission mask measurements are described here.



See also [Chapter 9.6.2, "Configuring Power Measurements"](#), on page 591.

- [Managing Measurement Configurations](#)..... 616
- [Controlling the Measurement](#)..... 617
- [Configuring a Multi-SEM Measurement](#)..... 618
- [Configuring a Sweep List](#)..... 619
- [Configuring the Reference Range](#)..... 633
- [Configuring the Power Classes](#)..... 635
- [Configuring the List Evaluation](#)..... 640
- [Performing an SEM Measurement](#)..... 641
- [Retrieving Results](#)..... 641
- [Example: SEM Measurement](#)..... 642

### 9.6.6.1 Managing Measurement Configurations

The following commands control measurement configurations for SEM measurements.

|                                                                                   |     |
|-----------------------------------------------------------------------------------|-----|
| <code>CALCulate&lt;n&gt;:LIMit&lt;li&gt;:ESPectrum&lt;sb&gt;:RESTore</code> ..... | 616 |
| <code>[SENSe:]ESPectrum&lt;sb&gt;:PRESet[:STANdard]</code> .....                  | 616 |
| <code>[SENSe:]ESPectrum&lt;sb&gt;:PRESet:RESTore</code> .....                     | 617 |
| <code>[SENSe:]ESPectrum&lt;sb&gt;:PRESet:STORe</code> .....                       | 617 |

---

#### **CALCulate<n>:LIMit<li>:ESPectrum<sb>:RESTore**

This command restores the predefined limit lines for the selected Spectrum Emission Mask standard.

All modifications made to the predefined limit lines are lost and the factory-set values are restored.

**Suffix:**

|      |            |
|------|------------|
| <n>  | irrelevant |
| <li> | irrelevant |
| <sb> | irrelevant |

**Example:**

```
CALC:LIM:ESP:REST
```

Resets the limit lines for the current Spectrum Emission Mask standard to the default setting.

---

#### **[SENSe:]ESPectrum<sb>:PRESet[:STANdard] <Standard>**

This command loads a measurement configuration.

Standard definitions are stored in an xml file. The default directory for SEM standards is `C:\Users\Public\Documents\Rohde-Schwarz\Analyzer\sem_std`.

**Suffix:**

|      |                                              |
|------|----------------------------------------------|
| <sb> | 1..n<br>Sub block in a Multi-SEM measurement |
|------|----------------------------------------------|



**Parameters:**

<Standard> String containing the file name.  
If you have stored the file in a subdirectory of the directory mentioned above, you have to include the relative path to the file.

**Manual operation:** See " [Standard](#) " on page 315  
See " [Load Standard](#) " on page 320

**[SENSe:]ESpectrum<sb>:PRESet:REStore**

This command restores the default configurations of predefined SEM standards.

Note that the command will overwrite customized standards that have the same name as predefined standards.

**Suffix:**

<sb> 1..n  
Sub block in a Multi-SEM measurement

**Manual operation:** See " [Restore Standard Files](#) " on page 320

**[SENSe:]ESpectrum<sb>:PRESet:StORe <Standard>**

This command saves the current SEM measurement configuration.

Standard definitions are stored in an xml file. The default directory for SEM standards is C:\Users\Public\Documents\Rohde-Schwarz\Analyzer\sem\_std.

**Suffix:**

<sb> 1..n  
Sub block in a Multi-SEM measurement

**Parameters:**

<Standard> String containing the file name.  
You can save the file in a subdirectory of the directory mentioned above. In that case, you have to include the relative path to the file.

**Manual operation:** See " [Save Standard](#) " on page 320

**9.6.6.2 Controlling the Measurement**

The following commands control the measurement itself.

|                                                   |     |
|---------------------------------------------------|-----|
| <a href="#">INITiate&lt;n&gt;:ESpectrum</a> ..... | 617 |
| <a href="#">[SENSe:]SWEep:MODE</a> .....          | 618 |

**INITiate<n>:ESpectrum**

This command initiates a Spectrum Emission Mask measurement.

**Suffix:**

<n> irrelevant

**[SENSe:]SWEep:MODE <Mode>**

This command selects the spurious emission and spectrum emission mask measurements.

You can select other measurements with

- `CALCulate<n>:MARKer<m>:FUNction:POWer<sb>[:STATe]`

**Parameters:**

<Mode> LIST | AUTO | ESpectrum

**AUTO**  
Turns on basic spectrum measurements.

**ESpectrum**  
Turns on spectrum emission mask measurements.

**LIST**  
Turns on spurious emission measurements.

\*RST: AUTO

**9.6.6.3 Configuring a Multi-SEM Measurement**

In the Spectrum application only, spectrum emissions can be measured for multiple sub blocks of channels (see "[SEM with Multiple Sub Blocks \("Multi-SEM"\)](#)" on page 304). Up to three sub blocks (with two gaps) can be defined. For each sub block, the familiar configuration settings concerning ranges, limit lines etc. can be defined in individual tabs (select the sub block using the <sb> suffix in the corresponding commands). In addition, settings on the sub blocks themselves must be configured.

Useful commands for multi-SEM measurements described elsewhere:

- `[SENSe:]ESpectrum<sb>:RANGe<ri>:MLCalc` on page 630

**Remote commands exclusive to multi-SEM measurements**

`[SENSe:]ESpectrum<sb>:SCENter`.....618  
`[SENSe:]ESpectrum<sb>:SCOunt`.....619

**[SENSe:]ESpectrum<sb>:SCENter <Frequency>**

This command defines the center frequency of the selected sub block in a Multi-SEM measurement.

**Suffix:**

<sb> 1..n  
Sub block in a Multi-SEM measurement

**Parameters:**

<Frequency> Frequency within the currently defined global span (see `[SENSe:]FREquency:SPAN` on page 715 and `[SENSe:]FREquency:CENTer` on page 713).

Range: 1 to 3  
 \*RST: 1  
 Default unit: Hz

**Example:** ESP1:SCEN 1GHZ

**Manual operation:** See " Sub Block / Center Freq " on page 315

---

**[SENSe:]ESpectrum<sb>:SCount <Subblocks>**

This command defines the number of sub blocks in the SEM measurement.

**Suffix:**

<sb> irrelevant

**Parameters:**

<Subblocks> Number of sub blocks in the SEM measurement.

Range: 1 to 3

\*RST: 1

**Example:** ESP:SCO 2

**Manual operation:** See " Sub Block Count " on page 315

#### 9.6.6.4 Configuring a Sweep List

The following commands define a sweep list for SEM measurements.



The sweep list cannot be configured using remote commands during an on-going sweep operation.

See also:

- `CALCulate<n>:LIMit<li>:ESpectrum<sb>:PCLass<pc>:LIMit[:STATE]` on page 638

|                                                                                                        |     |
|--------------------------------------------------------------------------------------------------------|-----|
| <code>[SENSe:]ESpectrum&lt;sb&gt;:HSPeEd</code> .....                                                  | 620 |
| <code>[SENSe:]ESpectrum&lt;sb&gt;:RANGe&lt;ri&gt;:BANDwidth:RESolution</code> .....                    | 620 |
| <code>[SENSe:]ESpectrum&lt;sb&gt;:RANGe&lt;ri&gt;:BANDwidth:VIDeo</code> .....                         | 621 |
| <code>[SENSe:]ESpectrum&lt;sb&gt;:RANGe&lt;ri&gt;:COUNT?</code> .....                                  | 621 |
| <code>[SENSe:]ESpectrum&lt;sb&gt;:RANGe&lt;ri&gt;:DELete</code> .....                                  | 621 |
| <code>[SENSe:]ESpectrum&lt;sb&gt;:RANGe&lt;ri&gt;:FILTer:TYPE</code> .....                             | 621 |
| <code>[SENSe:]LIST:RANGe&lt;ri&gt;[:FREQuency]:START</code> .....                                      | 622 |
| <code>[SENSe:]LIST:RANGe&lt;ri&gt;[:FREQuency]:STOP</code> .....                                       | 623 |
| <code>[SENSe:]ESpectrum&lt;sb&gt;:RANGe&lt;ri&gt;:INPut:ATTenuation</code> .....                       | 623 |
| <code>[SENSe:]ESpectrum&lt;sb&gt;:RANGe&lt;ri&gt;:INPut:ATTenuation:AUTO</code> .....                  | 623 |
| <code>[SENSe:]ESpectrum&lt;sb&gt;:RANGe&lt;ri&gt;:INPut:GAIN[:VALue]</code> .....                      | 624 |
| <code>[SENSe:]ESpectrum&lt;sb&gt;:RANGe&lt;ri&gt;:INPut:GAIN:STATE</code> .....                        | 624 |
| <code>[SENSe:]ESpectrum&lt;sb&gt;:RANGe&lt;ri&gt;:INSert</code> .....                                  | 624 |
| <code>[SENSe:]ESpectrum&lt;sb&gt;:RANGe&lt;ri&gt;:LIMit&lt;li&gt;:ABSolute:START</code> .....          | 625 |
| <code>[SENSe:]ESpectrum&lt;sb&gt;:RANGe&lt;ri&gt;:LIMit&lt;li&gt;:ABSolute:STOP</code> .....           | 625 |
| <code>[SENSe:]ESpectrum&lt;sb&gt;:RANGe&lt;ri&gt;:LIMit&lt;li&gt;:RELative:START</code> .....          | 626 |
| <code>[SENSe:]ESpectrum&lt;sb&gt;:RANGe&lt;ri&gt;:LIMit&lt;li&gt;:RELative:START:ABS</code> .....      | 626 |
| <code>[SENSe:]ESpectrum&lt;sb&gt;:RANGe&lt;ri&gt;:LIMit&lt;li&gt;:RELative:START:FUNCTION</code> ..... | 627 |
| <code>[SENSe:]ESpectrum&lt;sb&gt;:RANGe&lt;ri&gt;:LIMit&lt;li&gt;:RELative:STOP</code> .....           | 628 |
| <code>[SENSe:]ESpectrum&lt;sb&gt;:RANGe&lt;ri&gt;:LIMit&lt;li&gt;:RELative:STOP:ABS</code> .....       | 628 |

|                                                                       |     |
|-----------------------------------------------------------------------|-----|
| [SENSe:]ESpectrum<sb>:RANGe<ri>:LIMit<lj>:RELative:STOP:FUNCtion..... | 629 |
| [SENSe:]ESpectrum<sb>:RANGe<ri>:LIMit<lj>:STATe.....                  | 629 |
| [SENSe:]ESpectrum<sb>:RANGe<ri>:POINts:MINimum[:VALue].....           | 630 |
| [SENSe:]ESpectrum<sb>:RANGe<ri>:MLCalc.....                           | 630 |
| [SENSe:]ESpectrum<sb>:RANGe<ri>:RLEVel.....                           | 631 |
| [SENSe:]ESpectrum<sb>:RANGe<ri>:SWEep:TIME.....                       | 631 |
| [SENSe:]ESpectrum<sb>:RANGe<ri>:SWEep:TIME:AUTO.....                  | 632 |
| [SENSe:]ESpectrum<sb>:RANGe<ri>:TRANsducer.....                       | 632 |
| [SENSe:]ESpectrum<sb>:SSETup.....                                     | 633 |

---

### [SENSe:]ESpectrum<sb>:HSPeEd <State>

This command turns high speed mode for SEM measurements on and off.

For more information including restrictions see "[Fast SEM Measurements](#)" on page 303.

#### Suffix:

<sb>

#### Parameters:

<State>                    ON | OFF | 0 | 1  
**OFF | 0**  
 Switches the function off  
**ON | 1**  
 Switches the function on

**Example:**                ESP:HSP ON

**Manual operation:**    See "[Fast SEM](#)" on page 310

---

### [SENSe:]ESpectrum<sb>:RANGe<ri>:BANDwidth:RESolution <RBW>

This command defines the resolution bandwidth for a SEM range.

In case of high speed measurements, the resolution bandwidth has to be identical for all ranges.

#### Suffix:

<sb>                        1..n

<ri>                        1..n  
 Selects the measurement range.

#### Parameters:

<RBW>                    Resolution bandwidth.  
 Refer to the data sheet for available resolution bandwidths.  
 \*RST:                    30.0 kHz  
 Default unit: Hz

**Manual operation:**    See "[RBW](#)" on page 310

**[SENSe:]ESPectrum<sb>:RANGe<ri>:BANDwidth:VIDeo <VBW>**

This command defines the video bandwidth for a SEM range.

In case of high speed measurements, the video bandwidth has to be identical for all ranges.

**Suffix:**

<sb> 1..n

<ri> 1..n

Selects the measurement range.

**Parameters:**

<VBW> Video bandwidth.

Refer to the data sheet for available video bandwidths.

\*RST: 10.0 MHz

Default unit: Hz

**Manual operation:** See " [VBW](#) " on page 311

**[SENSe:]ESPectrum<sb>:RANGe<ri>:COUNT?**

This command queries the number of ranges in the sweep list.

**Suffix:**

<sb>

<ri> irrelevant

**Return values:**

<Ranges> Number of ranges in the sweep list.

**Usage:** Query only

**[SENSe:]ESPectrum<sb>:RANGe<ri>:DELeTe**

This command removes a range from the sweep list.

Note that

- you cannot delete the reference range
- a minimum of three ranges is mandatory.

**Suffix:**

<sb>

<ri> Selects the measurement range.

**Manual operation:** See " [Delete Range](#) " on page 314

**[SENSe:]ESPectrum<sb>:RANGe<ri>:FILTer:TYPE <FilterType>**

This command selects the filter type for an SEM range.

In case of high speed measurements, the filter has to be identical for all ranges.

The EMI-specific filter types are available if the EMI (R&S FPL1-K54) measurement option is installed, even if EMI measurement is not active. For details see "[Resolution Bandwidth and Filter Types](#)" on page 388.

**Suffix:**

<sb> 1 | 2 | 3

<ri> 1...30  
Selects the measurement range.

**Parameters:**

<FilterType> **NORMAL**  
Gaussian filters

**CFILter**  
channel filters

**RRC**  
RRC filters

**CISPr | PULSe**  
CISPR (6 dB) - requires EMI (R&S FPL1-K54) option  
Return value for query is always *PULS*.

**MIL**  
MIL Std (6 dB) - requires EMI (R&S FPL1-K54) option

**P5**  
5 Pole filters

\*RST: NORM  
Refer to the datasheet for available filter bandwidths.

**Manual operation:** See "[Filter Type](#)" on page 310

---

**[SENSe:]LIST:RANGe<ri>[:FREQuency]:START <Frequency>**

This command defines the start frequency of a spurious emission measurement range.

Make sure to set an appropriate span. If you set a span that is

- smaller than the span the sweep list covers, the R&S FPL1000 will not measure the ranges that are outside the span - results may be invalid.
- greater than the span the sweep list covers, the R&S FPL1000 will adjust the start frequency of the first range and the stop frequency of the last range to the span

**Suffix:**

<ri> 1..n  
Selects the measurement range.

**Parameters:**

<Frequency> Numeric value.

\*RST: -12.75 MHz (range 1), -2.515 MHz (range 2), 2.515 MHz (range 3)  
Default unit: Hz

**Manual operation:** See "[Range Start / Range Stop](#)" on page 310  
See "[Range Start / Range Stop](#)" on page 340

**[SENSe:]LIST:RANGe<ri>[:FREQuency]:STOP <Frequency>**

This command defines the stop frequency of a spurious emission measurement range.

Make sure to set an appropriate span. If you set a span that is

- smaller than the span the sweep list covers, the R&S FPL1000 will not measure the ranges that are outside the span - results may be invalid.
- greater than the span the sweep list covers, the R&S FPL1000 will adjust the start frequency of the first range and the stop frequency of the last range to the span

**Suffix:**

<ri> 1..n  
Selects the measurement range.

**Parameters:**

<Frequency> Numeric value.  
\*RST: -2.52 MHz (range 1), 2.52 MHz (range 2), 250.0 MHz (range 3)  
Default unit: Hz

**Manual operation:** See " [Range Start / Range Stop](#) " on page 310  
See " [Range Start / Range Stop](#) " on page 340

**[SENSe:]ESpectrum<sb>:RANGe<ri>:INPut:ATTenuation <Attenuation>**

This command defines the input attenuation for a SEM range.

In case of high speed measurements, the input attenuation has to be identical for all ranges.

**Suffix:**

<sb> 1..n  
<ri> 1..n  
Selects the measurement range.

**Parameters:**

<Attenuation> Numeric value.  
Refer to the data sheet for the attenuation range.  
\*RST: 10 dB  
Default unit: dB

**Manual operation:** See " [RF Attenuation](#) " on page 311

**[SENSe:]ESpectrum<sb>:RANGe<ri>:INPut:ATTenuation:AUTO <State>**

This command turns automatic selection of the input attenuation for a SEM range on and off.

In case of high speed measurements, the input attenuation has to be identical for all ranges.

**Suffix:**

<sb> 1..n

<ri> 1..n  
Selects the measurement range.

**Parameters:**

<State> ON | OFF | 0 | 1  
\*RST: 1

**Example:** ESP:RANG2:INP:ATT:AUTO OFF  
Deactivates the RF attenuation auto mode for range 2.

**Manual operation:** See " [RF Att Mode](#) " on page 311

**[SENSe:]ESpectrum<sb>:RANGe<ri>:INPut:GAIN[:VALue] <Gain>**

This command selects the gain for a SEM range.

In case of high speed measurements, the level of the preamplifier has to be identical for all ranges.

**Suffix:**

<sb> 1 | 2 | 3

<ri> 1..30  
Selects the measurement range.

**[SENSe:]ESpectrum<sb>:RANGe<ri>:INPut:GAIN:STATe <State>**

This command turns the preamplifier for a SEM range on and off.

In case of high speed measurements, the state of the preamplifier has to be identical for all ranges.

**Suffix:**

<sb> 1..n

<ri> 1..n  
Selects the measurement range.

**Parameters:**

<State> ON | OFF | 1 | 0  
\*RST: 0

**Manual operation:** See " [Preamp](#) " on page 312

**[SENSe:]ESpectrum<sb>:RANGe<ri>:INSert <Mode>**

This command inserts a new SEM range and updates the range numbers accordingly.

**Suffix:**

<sb> 1..n

<ri> 1..n  
Selects the SEM range.

**Parameters:**

<Mode> AFTer | BEFore



**AFTer**

Inserts a range after the selected range.

**BEFore**

Inserts a range before the selected range.

**Manual operation:** See "[Insert before Range / Insert after Range](#)" on page 314

---

**[SENSe:]ESpectrum<sb>:RANGe<ri>:LIMit<li>:ABSolute:START <Level>**

This command defines an absolute limit for a SEM range.

Unlike manual operation, you can define an absolute limit anytime and regardless of the limit check mode.

**Suffix:**

|      |                                                     |
|------|-----------------------------------------------------|
| <sb> | 1..n                                                |
| <ri> | 1..n<br>Selects the measurement range.              |
| <li> | 1..n<br>Power class for which the limit is defined. |

**Parameters:**

|         |                                                                                                               |
|---------|---------------------------------------------------------------------------------------------------------------|
| <Level> | Absolute limit at the start frequency of a SEM range.<br>Range: -400 to 400<br>*RST: -13<br>Default unit: dBm |
|---------|---------------------------------------------------------------------------------------------------------------|

**Example:** `SENSe:ESpectrum:RANGe:LIMit:ABSolute:START -10`  
For a detailed example see [Chapter 9.6.6.10, "Example: SEM Measurement"](#), on page 642.

**Manual operation:** See "[Abs Limit Start / Stop <n>](#)" on page 312

---

**[SENSe:]ESpectrum<sb>:RANGe<ri>:LIMit<li>:ABSolute:STOP <Level>**

This command defines an absolute limit for a SEM range.

Unlike manual operation, you can define an absolute limit anytime and regardless of the limit check mode.

**Suffix:**

|      |                                                     |
|------|-----------------------------------------------------|
| <sb> | 1..n                                                |
| <ri> | 1..n<br>Selects the measurement range.              |
| <li> | 1..n<br>Power class for which the limit is defined. |

**Parameters:**

<Level> Absolute limit at the stop frequency of a SEM range.  
 Range: -400 to 400  
 \*RST: -13  
 Default unit: dBm

**Example:**

SENSe:ESpectrum:RANGe:LIMit:ABSolute:STOP -15  
 For a detailed example see [Chapter 9.6.6.10, "Example: SEM Measurement"](#), on page 642.

**Manual operation:** See "[Abs Limit Start / Stop <n>](#)" on page 312

**[SENSe:]ESpectrum<sb>:RANGe<ri>:LIMit<li>:RELative:STARt <Level>**

This command defines a relative limit for a SEM range.

Unlike manual operation, you can define a relative limit regardless of the limit check mode.

**Suffix:**

<sb> 1..n  
 <ri> 1..n  
 Selects the SEM range.  
 <li> 1..n  
 Power class for which the limit is defined.

**Parameters:**

<Level> Relative limit at the start frequency of a SEM range.  
 Range: -400 to 400  
 \*RST: -50  
 Default unit: dBc

**Example:**

SENS:ESP:RANG:LIM:REL:STAR -10

**Manual operation:** See "[Rel Limit Start / Stop <n>](#)" on page 312

**[SENSe:]ESpectrum<sb>:RANGe<ri>:LIMit<li>:RELative:STARt:ABS <Level>**

This command defines an absolute limit for the MAX function of the relative limit for a SEM range.

For more information see "[Relative limit line functions](#)" on page 302.

**Suffix:**

<sb> 1..n  
 <ri> 1..n  
 Selects the SEM range.  
 <li> 1..n  
 Power class for which the limit is defined.

**Parameters:**

<Level> Absolute limit at the start frequency of a SEM range to be used in addition to the relative limit if the MAX function is enabled (see [\[SENSe:\]ESpectrum<sb>:RANGe<ri>:LIMit<li>:RELative:START:FUNCTION](#) on page 627).

Range: -400 to 400  
 \*RST: -13  
 Default unit: dBm

**Example:**

```
SENSe:ESpectrum:RANGe:LIMit:RELative:START:
ABSolute -10
```

For a detailed example see [Chapter 9.6.6.10, "Example: SEM Measurement"](#), on page 642.

**Manual operation:** See "[Rel Limit Start / Stop <n>](#)" on page 312

---

**[SENSe:]ESpectrum<sb>:RANGe<ri>:LIMit<li>:RELative:START:FUNCTION**  
 <Function>

**Suffix:**

<sb> 1..n

<ri> 1..n  
 Selects the SEM range.

<li> 1..n  
 Power class for which the limit is defined.

**Parameters:**

<Function> OFF | MAX

Defines the function to be used to determine the relative limit line start value

**MAX**  
 The maximum of the relative *and* the absolute level is used as the limit start value. Use the [\[SENSe:\]ESpectrum<sb>:RANGe<ri>:LIMit<li>:RELative:START](#) and [\[SENSe:\]ESpectrum<sb>:RANGe<ri>:LIMit<li>:RELative:START:ABS](#) commands to define these values.

**OFF**  
 No function is used, the relative limit line is defined by a fixed relative start value. Use the [\[SENSe:\]ESpectrum<sb>:RANGe<ri>:LIMit<li>:RELative:START](#) command to define this value.

\*RST: OFF

**Example:**

```
SENSe:ESpectrum:RANGe:LIMit:RELative:START:
FUNCTION MAX
```

For a detailed example see [Chapter 9.6.6.10, "Example: SEM Measurement"](#), on page 642.

**Manual operation:** See "[Rel Limit Start / Stop <n>](#)" on page 312

**[SENSe:]ESpectrum<sb>:RANGe<ri>:LIMit<li>:RELative:STOP <Level>**

This command defines a relative limit for a SEM range.

Unlike manual operation, you can define a relative limit anytime and regardless of the limit check mode.

**Suffix:**

|      |                                                     |
|------|-----------------------------------------------------|
| <sb> | 1..n                                                |
| <ri> | 1..n<br>Selects the SEM range.                      |
| <li> | 1..n<br>Power class for which the limit is defined. |

**Parameters:**

|         |                                                                                                              |
|---------|--------------------------------------------------------------------------------------------------------------|
| <Level> | Relative limit at the stop frequency of a SEM range.<br>Range: -400 to 400<br>*RST: -50<br>Default unit: dBc |
|---------|--------------------------------------------------------------------------------------------------------------|

**Example:**

SENSe:ESpectrum:RANGe:LIMit:RELative:STOP -15  
For a detailed example see [Chapter 9.6.6.10, "Example: SEM Measurement"](#), on page 642.

**Manual operation:** See "[Rel Limit Start / Stop <n>](#)" on page 312

**[SENSe:]ESpectrum<sb>:RANGe<ri>:LIMit<li>:RELative:STOP:ABS <Level>**

This command defines an absolute limit for the MAX function of the relative limit for a SEM range.

For more information see "[Relative limit line functions](#)" on page 302.

**Suffix:**

|      |                                                     |
|------|-----------------------------------------------------|
| <sb> | 1..n                                                |
| <ri> | 1..n<br>Selects the SEM range.                      |
| <li> | 1..n<br>Power class for which the limit is defined. |

**Parameters:**

|         |                                                                                                                                                                                                                                                                                                               |
|---------|---------------------------------------------------------------------------------------------------------------------------------------------------------------------------------------------------------------------------------------------------------------------------------------------------------------|
| <Level> | Absolute limit at the stop frequency of a SEM range to be used in addition to the relative limit if the MAX function is enabled (see <a href="#">[SENSe:]ESpectrum&lt;sb&gt;:RANGe&lt;ri&gt;:LIMit&lt;li&gt;:RELative:STOP:FUNCTION</a> on page 629).<br>Range: -400 to 400<br>*RST: -13<br>Default unit: dBm |
|---------|---------------------------------------------------------------------------------------------------------------------------------------------------------------------------------------------------------------------------------------------------------------------------------------------------------------|

**Example:**           SENSE:ESpectrum:RANGe:LIMit:RELative:STOP:  
ABSolute -15  
For a detailed example see [Chapter 9.6.6.10, "Example: SEM Measurement"](#), on page 642.

**Manual operation:** See "[Rel Limit Start / Stop <n>](#)" on page 312

---

**[SENSe:]ESpectrum<sb>:RANGe<ri>:LIMit<li>:RELative:STOP:FUNctIon**  
**<Function>**

This command enables the use of a function when defining the relative limit for a SEM range.

**Suffix:**

<sb>                   1..n  
<ri>                   1..n  
                          Selects the SEM range.  
<li>                   1..n  
                          Power class for which the limit is defined.

**Parameters:**

<Function>           OFF | MAX  
                          Defines the function to be used to determine the relative limit line stop value

**MAX**  
The maximum of the relative *and* the absolute level is used as the limit stop value. Use the [\[SENSe:\]ESpectrum<sb>:RANGe<ri>:LIMit<li>:RELative:STOP](#) and [\[SENSe:\]ESpectrum<sb>:RANGe<ri>:LIMit<li>:RELative:STOP:ABS](#) commands to define these values.

**OFF**  
No function is used, the relative limit line is defined by a fixed relative stop value. Use the [\[SENSe:\]ESpectrum<sb>:RANGe<ri>:LIMit<li>:RELative:STOP](#) command to define this value.

\*RST:                OFF

**Example:**           SENSE:ESpectrum:RANGe:LIMit:RELative:STOP:  
FUNctIon MAX  
For a detailed example see [Chapter 9.6.6.10, "Example: SEM Measurement"](#), on page 642.

**Manual operation:** See "[Rel Limit Start / Stop <n>](#)" on page 312

---

**[SENSe:]ESpectrum<sb>:RANGe<ri>:LIMit<li>:STATe <State>**

This command selects the limit check mode for *all* SEM ranges (<range> is irrelevant).

**Suffix:**

<sb>                   1..n

|      |                                                     |
|------|-----------------------------------------------------|
| <ri> | 1..n<br>Selects the SEM range.                      |
| <lj> | 1..n<br>Power class for which the limit is defined. |

**Parameters:**

|         |                                                                                                                                           |
|---------|-------------------------------------------------------------------------------------------------------------------------------------------|
| <State> | ABSolute   RELative   AND   OR                                                                                                            |
|         | <b>ABSolute</b><br>Checks only the absolute limits defined.                                                                               |
|         | <b>RELative</b><br>Checks only the relative limits. Relative limits are defined as relative to the measured power in the reference range. |
|         | <b>AND</b><br>Combines the absolute and relative limit. The limit check fails when both limits are violated.                              |
|         | <b>OR</b><br>Combines the absolute and relative limit. The limit check fails when one of the limits is violated.                          |
|         | *RST:       RELative                                                                                                                      |

**Manual operation:** See " [Limit Check <n>](#) " on page 312

---

**[SENSe:]ESpectrum<sb>:RANGe<ri>:POINTs:MINinum[:VALue]** <SweepPoint>

Defines the minimum number of sweep points for the range.

**Suffix:**

|      |                                |
|------|--------------------------------|
| <sb> |                                |
| <ri> | Selects the measurement range. |

**Parameters:**

|              |                                          |
|--------------|------------------------------------------|
| <SweepPoint> | Minimum number of sweep points per range |
|              | Range:     1 to 32001                    |
|              | *RST:     1                              |

**Example:**           SENSE1:ESpectrum:RANGe3:POINTs:MIN:VALue 400

**Manual operation:** See " [Min Sweep Points](#) " on page 313

---

**[SENSe:]ESpectrum<sb>:RANGe<ri>:MLCalc** <Function>

Defines the function used to calculate the limit line for the n-th power class for overlapping ranges in Multi-SEM measurements. For details see "[Limit calculation for individual ranges](#)" on page 306.

**Suffix:**

|      |                                              |
|------|----------------------------------------------|
| <sb> | 1..n<br>Sub block in a Multi-SEM measurement |
|------|----------------------------------------------|

<ri> 1..n  
Selects the measurement range.

**Parameters:**

<Function> NONE | MAX | SUM

**NONE**  
(reference ranges only:) the limit of the reference range is used;  
Reference ranges always use the function "NONE".

**SUM**  
sum of the two limit lines (calculated for linear powers) is used

**MAX**  
maximum of the two limit lines is used

\*RST: SUM (reference range: NONE)

**Manual operation:** See " [Multi-Limit Calc <n>](#) " on page 313

**[SENSe:]ESpectrum<sb>:RANGe<ri>:RLEVel <RefLevel>**

This command defines the reference level for a SEM range.

In case of high speed measurements, the reference level has to be identical for all ranges.

**Suffix:**

<sb> 1..n  
Sub block in a Multi-SEM measurement

<ri> 1..n  
Selects the measurement range.

**Parameters:**

<RefLevel> Reference level.  
Refer to the data sheet for the reference level range.

\*RST: 0 dBm  
Default unit: dBm

**Manual operation:** See " [Ref Level](#) " on page 311

**[SENSe:]ESpectrum<sb>:RANGe<ri>:SWEep:TIME <SweepTime>**

This command defines the sweep time for a SEM range.

In case of high speed measurements, the sweep time has to be identical for all ranges.

**Suffix:**

<sb> 1..n  
Sub block in a Multi-SEM measurement

<ri> 1..n  
Selects the measurement range.

**Parameters:**

<SweepTime> Sweep time.  
The range depends on the ratios of the span to the RBW and the RBW to the VBW. Refer to the data sheet for more information.  
Default unit: s

**Manual operation:** See " [Sweep Time](#) " on page 311

**[SENSe:]ESpectrum<sb>:RANGe<ri>:SWEp:TIME:AUTO <State>**

This command turns automatic selection of the sweep time for a SEM range on and off.

In case of high speed measurements, the sweep time has to be identical for all ranges.

**Suffix:**

<sb> 1..n  
<ri> 1..n  
Selects the measurement range.

**Parameters:**

<State> ON | OFF | 0 | 1  
\*RST: 1

**Example:**

ESP:RANG3:SWE:TIME:AUTO OFF  
Deactivates the sweep time auto mode for range 3.

**Manual operation:** See " [Sweep Time Mode](#) " on page 311

**[SENSe:]ESpectrum<sb>:RANGe<ri>:TRANsducer <Transducer>**

This command selects a transducer factor for a SEM range.

Note that

- the transducer must cover at least the span of the range
- the x-axis has to be linear
- the unit has to be dB

**Suffix:**

<sb> 1..n  
Sub block in a Multi-SEM measurement  
<ri> 1..n  
Selects the measurement range.

**Parameters:**

<Transducer> String containing the transducer file name, including the path information.

**Manual operation:** See " [Transducer Factor](#) " on page 312



**[SENSe:]ESpectrum<sb>:SSETup <State>**

Enables or disables symmetrical configuration of the range settings.

See "Ranges and Range Settings" on page 299.

**Suffix:**

<sb> 1..n

**Parameters:**

<State> ON | OFF | 0 | 1

**OFF | 0**

Switches the function off

**ON | 1**

Switches the function on

\*RST: 0

**Manual operation:** See "Symmetrical Setup" on page 314

**9.6.6.5 Configuring the Reference Range**

The following commands define the reference range for the SEM sweep list.

|                                                 |     |
|-------------------------------------------------|-----|
| [SENSe:]ESpectrum<sb>:BWID.....                 | 633 |
| [SENSe:]ESpectrum<sb>:FILTer[:RRC]:ALPHA.....   | 633 |
| [SENSe:]ESpectrum<sb>:FILTer[:RRC][:STATe]..... | 634 |
| [SENSe:]ESpectrum<sb>:RRANge?.....              | 634 |
| [SENSe:]ESpectrum<sb>:RTYPE.....                | 634 |

**[SENSe:]ESpectrum<sb>:BWID <Bandwidth>**

This command defines the channel bandwidth of the reference range.

The bandwidth is available if the power reference is the channel power.

**Suffix:**

<sb> 1..n  
Sub block in a Multi-SEM measurement

**Parameters:**

<Bandwidth> minimum span ≤ value ≤ span of reference range

\*RST: 3.84 MHz

Default unit: Hz

**Manual operation:** See "Tx Bandwidth" on page 316

**[SENSe:]ESpectrum<sb>:FILTer[:RRC]:ALPHA <Alpha>**

This command defines the roll-off factor for the RRC filter.

The RRC filter is available if the power reference is the channel power.

**Suffix:**

<sb> 1..n  
Sub block in a Multi-SEM measurement

**Parameters:**

<Alpha> Range: 0 to 1  
\*RST: 0.22

**Manual operation:** See " [Alpha](#):" on page 317

**[SENSe:]ESpectrum<sb>:FILTer[:RRC][:STATe] <State>**

This command turns the RRC filter in the reference range on and off.  
The RRC filter is available if the power reference is the channel power.

**Suffix:**

<sb> 1..n  
Sub block in a Multi-SEM measurement

**Parameters:**

<State> ON | OFF | 0 | 1  
\*RST: 1

**Manual operation:** See " [RRC Filter State](#) " on page 316

**[SENSe:]ESpectrum<sb>:RRANge?**

This command queries the reference range.

**Suffix:**

<sb> Sub block in a Multi-SEM measurement

**Return values:**

<RefRange> Number of the current reference range.  
Range: 1 to 30

**Usage:** Query only

**[SENSe:]ESpectrum<sb>:RTYPE <Type>**

This command defines the type of the power reference.

**Suffix:**

<sb> 1..n  
Sub block in a Multi-SEM measurement

**Parameters:**

<Type> PEAK | CPOWer

**PEAK**

Measures the highest peak within the reference range.

**CPOWer**

Measures the channel power within the reference range (integral bandwidth method).

\*RST: CPOWer

**Manual operation:** See " [Power Reference Type](#) " on page 316

### 9.6.6.6 Configuring the Power Classes

The following commands define the power classes for SEM measurements.

|                                                                    |     |
|--------------------------------------------------------------------|-----|
| CALCulate<n>:LIMit<li>:ESPectrum<sb>:LIMits.....                   | 635 |
| CALCulate<n>:LIMit<li>:ESPectrum<sb>:MODE.....                     | 636 |
| CALCulate<n>:LIMit<li>:ESPectrum<sb>:VALue.....                    | 636 |
| CALCulate<n>:LIMit<li>:ESPectrum<sb>:PCLass<pc>:COUNT.....         | 637 |
| CALCulate<n>:LIMit<li>:ESPectrum<sb>:PCLass<pc>[:EXCLusive].....   | 637 |
| CALCulate<n>:LIMit<li>:ESPectrum<sb>:PCLass<pc>:LIMit[:STATe]..... | 638 |
| CALCulate<n>:LIMit<li>:ESPectrum<sb>:PCLass<pc>:MAXimum.....       | 639 |
| CALCulate<n>:LIMit<li>:ESPectrum<sb>:PCLass<pc>:MINimum.....       | 639 |

---

#### CALCulate<n>:LIMit<li>:ESPectrum<sb>:LIMits <Max1>,<Max2>,<Max3>

This command sets or queries up to 4 power classes in one step. You can only define values for the number of power classes defined by `CALCulate<n>:LIMit<li>:ESPectrum<sb>:PCLass<pc>:COUNT` on page 637.

#### Suffix:

|      |            |
|------|------------|
| <n>  | irrelevant |
| <li> | irrelevant |
| <sb> |            |

#### Setting parameters:

|        |                                                                                                                                                                                                                                                                                                                                                    |
|--------|----------------------------------------------------------------------------------------------------------------------------------------------------------------------------------------------------------------------------------------------------------------------------------------------------------------------------------------------------|
| <Max1> | <p>Defines the value range for power class 1 as -200 to &lt;Max1&gt;.</p> <p>Only available for <code>CALC:LIM:ESP:PCL:COUNT &gt;=2</code></p> <p>If only 2 power classes are defined, the value range for power class 2 is defined as &lt;Max1&gt; to 200.</p> <p>Range: -199 to + 199</p> <p>Default unit: DBM</p>                               |
| <Max2> | <p>Defines the value range for power class 2 as &lt;Max1&gt; to &lt;Max2&gt;.</p> <p>Only available for <code>CALC:LIM:ESP:PCL:COUNT &gt;=3</code></p> <p>If only 3 power classes are defined, the value range for power class 3 is defined as &lt;Max2&gt; to 200.</p> <p>Range: -199 to + 199, &lt;Max2&gt; must be higher than &lt;Max1&gt;</p> |

<Max3> Defines the value range for power class 3 as <Max2> to <Max3>.  
 The value range for power class 4 is defined as <Max3> to 200.  
 Only available for `CALC:LIM:ESP:PCL:COUNT = 4`  
 Range: -199 to + 199, <Max3> must be higher than <Max2>

**Example:** `CALC:LIM:ESP:LIM -50,50,70`  
 Defines the following power classes:  
 <-200, -50>  
 <-50, 50>  
 <50, 70>  
 <70, 200>  
 Query:  
`CALC:LIM:ESP:LIM?`  
 Response:  
 -200,-50,50,70,200

---

#### **CALCulate<n>:LIMit<li>:ESPectrum<sb>:MODE <Mode>**

Which limit line is to be used for an SEM measurement depends on the power class the input signal power belongs to. This command defines whether the power class is determined automatically or manually.

##### **Suffix:**

<n> irrelevant  
 <li> irrelevant  
 <sb> 1..n

##### **Parameters:**

<Mode> **AUTO**  
 The power class (and thus the limit line) is assigned dynamically according to the currently measured channel power.

**MANUAL**  
 One of the specified power classes is selected manually for the entire measurement. The selection is made with the `CALCulate<n>:LIMit<li>:ESPectrum<sb>:PCLass<pc>[:EXCLUSIVE]` command.

\*RST: AUTO

**Example:** `CALC:LIM:ESP:MODE AUTO`  
 Activates automatic selection of the limit line.

---

#### **CALCulate<n>:LIMit<li>:ESPectrum<sb>:VALue <Power>**

This command activates the manual limit line selection as and specifies the expected power as a value. Depending on the entered value, the associated predefined limit lines is selected.

This command has the same effect as a combination of the `CALC:LIM:ESP:MODE MAN` and the `CALCulate<n>:LIMit<li>:ESpectrum<sb>:PCLass<pc>[:EXCLusive]` commands; however, the power class to be used is not defined directly, but via the expected power. As opposed to `CALC:LIM:ESP:MODE AUTO`, the power class is not re-assigned to the input signal power dynamically, but only once when the command is executed.

**Suffix:**

<n> irrelevant  
 <li> irrelevant  
 <sb> 1..n

**Parameters:**

<Power> integer  
 Range: -200 to 199  
 \*RST: 0

**Example:**

`CALC:LIM:ESP:VAL 33`  
 Activates manual selection of the limit line and selects the limit line for P = 33.

**CALCulate<n>:LIMit<li>:ESpectrum<sb>:PCLass<pc>:COUNT <NoPowerClasses>**

This command sets the number of power classes to be defined.

This command must be executed before any new power class values can be defined using `CALCulate<n>:LIMit<li>:ESpectrum<sb>:PCLass<pc>:MAXimum` and `CALCulate<n>:LIMit<li>:ESpectrum<sb>:PCLass<pc>:MINimum`.

**Suffix:**

<n> irrelevant  
 <li> irrelevant  
 <sb> 1..n  
 <pc> irrelevant

**Parameters:**

<NoPowerClasses> 1 to 4  
 \*RST: 1

**Example:**

`CALC:LIM:ESP:PCL:COUN 2`  
 Two power classes can be defined.

**Manual operation:** See "[Adding or Removing a Power Class](#)" on page 318

**CALCulate<n>:LIMit<li>:ESpectrum<sb>:PCLass<pc>[:EXCLusive] <State>**

This command selects the power class used by the measurement if `CALCulate<n>:LIMit<li>:ESpectrum<sb>:MODE` is set to manual.

Note that:

- You can only use power classes for which limits are defined.

**Suffix:**

|      |                     |
|------|---------------------|
| <n>  | irrelevant          |
| <li> | irrelevant          |
| <sb> | 1..n                |
| <pc> | 1..n<br>power class |

**Parameters:**

|         |                  |
|---------|------------------|
| <State> | ON   OFF   1   0 |
| *RST:   | 0                |

**Example:**

```
CALC:LIM:ESP:PCL1 ON
```

Activates the first defined power class.

**Manual operation:** See "[Used Power Classes](#):" on page 317

**CALCulate<n>:LIMit<li>:ESPectrum<sb>:PCLass<pc>:LIMit[:STATe] <State>**

This command selects the limit check mode for each power class.

**Suffix:**

|      |                     |
|------|---------------------|
| <n>  | irrelevant          |
| <li> | irrelevant          |
| <sb> | 1..n                |
| <pc> | 1..n<br>power class |

**Parameters:**

|         |                                |
|---------|--------------------------------|
| <State> | ABSolute   RELative   AND   OR |
|---------|--------------------------------|

**ABSolute**

Evaluates only limit lines with absolute power values

**RELative**

Evaluates only limit lines with relative power values

**AND**

Evaluates limit lines with relative and absolute power values. A negative result is returned if both limits fail.

**OR**

Evaluates limit lines with relative and absolute power values. A negative result is returned if at least one limit failed.

```
*RST: REL
```

**Example:**

```
CALC:LIM:ESP:PCL:LIM ABS
```

**Manual operation:** See "[Used Power Classes](#):" on page 317

**CALCulate<n>:LIMit<li>:ESpectrum<sb>:PCLass<pc>:MAXimum <Level>**

This command defines the upper limit of a particular power class.

Note:

- The last power class always has an upper limit of 200 dBm.
- The upper limit of a power class must always be the same as the lower limit of the subsequent power class.
- The power class must already exist (see [CALCulate<n>:LIMit<li>:ESpectrum<sb>:PCLass<pc>:COUNT](#) on page 637).

**Suffix:**

|      |                     |
|------|---------------------|
| <n>  | irrelevant          |
| <li> | irrelevant          |
| <sb> | 1..n                |
| <pc> | 1..n<br>power class |

**Parameters:**

|         |                                                   |
|---------|---------------------------------------------------|
| <Level> | Range: -199.9 dBm to 200 dBm<br>Default unit: dBm |
|---------|---------------------------------------------------|

**Example:**

```
CALC:LIM:ESP:PCL1:MAX -40 dBm
```

Sets the maximum power value of the first power class to -40 dBm.

**Manual operation:** See " PMin / PMax " on page 318

**CALCulate<n>:LIMit<li>:ESpectrum<sb>:PCLass<pc>:MINimum <Level>**

This command defines the lower limit of a particular power class.

Note:

- The first power class always has a lower limit of -200 dBm.
- The lower limit of a power class must always be the same as the upper limit of the previous power class.
- The power class must already exist (see [CALCulate<n>:LIMit<li>:ESpectrum<sb>:PCLass<pc>:COUNT](#) on page 637).

**Suffix:**

|      |                     |
|------|---------------------|
| <n>  | irrelevant          |
| <li> | irrelevant          |
| <sb> | 1..n                |
| <pc> | 1..n<br>power class |

**Parameters:**

|         |                                                   |
|---------|---------------------------------------------------|
| <Level> | Range: -200 dBm to 199.9 dBm<br>Default unit: dBm |
|---------|---------------------------------------------------|

**Example:** `CALC:LIM:ESP:PCL2:MIN -40 dBm`  
Sets the minimum power value of the second power class to -40 dBm.

**Manual operation:** See " [PMin / PMax](#) " on page 318

### 9.6.6.7 Configuring the List Evaluation

The following commands configure the list evaluation.

#### Useful commands for SEM measurements described elsewhere

- `MMEMoRY:STORe<n>:LIST` on page 887

#### Remote commands exclusive to SEM measurements

|                                                                        |     |
|------------------------------------------------------------------------|-----|
| <code>CALCulate&lt;n&gt;:ESpectrum:PSEarch:AUTO</code> .....           | 640 |
| <code>CALCulate&lt;n&gt;:ESpectrum:PEAKsearch:AUTO</code> .....        | 640 |
| <code>CALCulate&lt;n&gt;:ESpectrum:PSEarch[:IMMEDIATE]</code> .....    | 640 |
| <code>CALCulate&lt;n&gt;:ESpectrum:PEAKsearch[:IMMEDIATE]</code> ..... | 640 |
| <code>CALCulate&lt;n&gt;:ESpectrum:PSEarch:MARGIN</code> .....         | 641 |
| <code>CALCulate&lt;n&gt;:ESpectrum:PEAKsearch:MARGIN</code> .....      | 641 |
| <code>CALCulate&lt;n&gt;:ESpectrum:PSEarch:PSHOW</code> .....          | 641 |
| <code>CALCulate&lt;n&gt;:ESpectrum:PEAKsearch:PSHOW</code> .....       | 641 |

---

**`CALCulate<n>:ESpectrum:PSEarch:AUTO <State>`**

**`CALCulate<n>:ESpectrum:PEAKsearch:AUTO <State>`**

This command turns the list evaluation on and off.

**Suffix:**

<n> [Window](#)

**Parameters:**

<State> ON | OFF | 0 | 1  
\*RST: 1

**Example:** `CALC:ESP:PSE:AUTO OFF`  
Deactivates the list evaluation.

**Manual operation:** See " [List Evaluation State \(Result Summary\)](#) " on page 321  
See " [List Evaluation State](#) " on page 343

---

**`CALCulate<n>:ESpectrum:PSEarch[:IMMEDIATE]`**

**`CALCulate<n>:ESpectrum:PEAKsearch[:IMMEDIATE]`**

This command initiates a list evaluation.

**Suffix:**

<n> [Window](#)



---

**CALCulate<n>:ESPectrum:PSEarch:MARGin <Threshold>**  
**CALCulate<n>:ESPectrum:PEAKsearch:MARGin <Margin>**

This command defines the threshold of the list evaluation.

**Suffix:**

<n> [Window](#)

**Parameters:**

<Margin> Range: -200 to 200  
 \*RST: 200  
 Default unit: dB

**Example:** `CALC:ESP:PSE:MARG 100`  
 Sets the margin to 100 dB.

**Manual operation:** See " [Margin](#) " on page 321  
 See " [Margin](#) " on page 344

---

**CALCulate<n>:ESPectrum:PSEarch:PSHow <State>**  
**CALCulate<n>:ESPectrum:PEAKsearch:PSHow <State>**

This command turns the peak labels in the diagram on and off.

Peak labels are blue squares.

**Suffix:**

<n> [Window](#)

**Parameters:**

<State> ON | OFF | 1 | 0  
 \*RST: 0

**Example:** `CALC:ESP:PSE:PSH ON`  
 Marks all peaks with blue squares.

**Manual operation:** See " [Show Peaks](#) " on page 321  
 See " [Show Peaks](#) " on page 343

### 9.6.6.8 Performing an SEM Measurement

The following commands are required to perform an SEM measurement:

- `SENS:SWE:MODE ESP`, see [`SENSe:`] `SWEep:MODE` on page 618
- `INITiate<n>[:IMMediate]` on page 590

### 9.6.6.9 Retrieving Results

The following commands analyze and retrieve measurement results for SEM measurements.

- `TRACe<n>[:DATA]` on page 776
- `TRACe<n>[:DATA]:MEMory?` on page 778

- TRACe<n>[:DATA]:X? on page 778
- CALCulate<n>:MARKer<m>:FUNction:POWer<sb>:RESult? on page 592

#### 9.6.6.10 Example: SEM Measurement

In this example we will configure and perform an SEM measurement. Note that this example is primarily meant to demonstrate the remote control commands, it does not necessarily reflect a useful measurement task. For most common measurement standards, the R&S FPL1000 performs the measurement optimally with the predefined settings, without further configuration.

```
//-----Preparing the measurement -----
//Reset the instrument
*RST

//----- Preparing the measurement-----
//Activate SEM Measurement
SWE:MODE ESP

//Selects single sweep mode.
//SEM has to be in single sweep mode to be configured and no sweep operation
//may be running!
// If required, a sweep stop can be ensured by INIT:IMM;*WAI
INIT:CONT OFF

//----- Managing Measurement Configurations-----
//Load the 3GPP configuration stored in the file '3GPP_UL.xml'
ESP:PRES 'WCDMA\3GPP\UL\3GPP_UL.xml'

//----- Defining the Reference Range-----
//Query the current reference range.
ESP:RRAN?
//Select the channel power as the power reference.
ESP:RTYP CPOW
//Define a channel bandwidth of 4 MHz for the power reference.
ESP:BWID 4 MHZ
//Use an RRC filter with a roll-off factor of 0.5 when measuring
//the reference power.
ESP:FILT:RRC ON
ESP:FILT:ALPH 0.5

//----- Configuring Power Classes-----
//Define 3 power classes.
CALC:LIM:ESP:PCL:COUN 3
//Define the value ranges of the three power classes as [dBm]:
//power class 1: -200 to -100
//power class 2: -100 to 0
//power class 3: 0 to 200
```

```

CALC:LIM:ESP:LIM -100,0
//Define an absolute limit check for class 1.
CALC:LIM:ESP:PCL1:LIM ABS
//Define a relative limit check for class 2.
CALC:LIM:ESP:PCL2:LIM REL
//Define a manual selection of the power class.
CALC:LIM:ESP:MODE MAN
//Activate the use of the second power class for the entire measurement.
CALC:LIM:ESP:PCL2 ON

//----- Configuring a Sweep List-----
//Insert a range after range 2.
ESP:RANG2:INS AFT
//Insert a range before range 1.
ESP:RANG1:INS BEF
//Query the number of measurement ranges in the sweep list (currently 11).
ESP:RANG:COUNT?
//Delete the 11th range.
ESP:RANG5:DEL

//Define a stop frequency of -9 MHz for range 1.
ESP:RANG1:STOP -10000000

//Define a start frequency of -10 MHz for range 2.
ESP:RANG2:STAR -9000000

//Switch off Fast SEM mode so the ranges can be configured individually.
ESP:HSP OFF

//Define a resolution bandwidth of 1 MHz for range 2.
ESP:RANG2:BAND:RES 1000000

//Select an RRC filter for range 2.
ESP:RANG2:FILT:TYPE RRC

//Define a video bandwidth of 5 MHz for range 2.
ESP:RANG2:BAND:VID 5000000
//Define a sweep time of 1 second for range 2.
ESP:RANG2:SWE:TIME 1
//Define a reference level of 0 dBm for range 2.
ESP:RANG2:RLEV 0
//Define an input attenuation of 10 dB for range 2.
ESP:RANG2:INP:ATT 10

// Create a transducer that can be used.
// It has to cover the corresponding frequency range

SENSE1:CORREction:TRANSDUCER:SElect 'Transducer'
SENSE1:CORREction:TRANSDUCER:UNIT 'DB'
SENSE1:CORREction:TRANSDUCER:COMment 'Test Transducer'

```

## Configuring and Performing Measurements

```

// Frequency Span 0 MHz bis 20 Ghz
SENSe1:CORRection:TRANsducer:DATA 0e6,5, 20e9,3

//Include a transducer called 'transducer' for range 2.
ESP:RANG2:TRAN 'Transducer'

//----- Configuring the limit check-----

//Check the absolute and relative limits for all ranges in power class 1 and
//fails if both limits are violated. Since power class 2 is set to be used for
//the entire measurement, values for Limit Check 1 are irrelevant. They are
//defined here to demonstrate the use of the MAX function for relative limits.
ESP:RANG:LIM1:STAT AND
//Enable the use of maximum function for relative limit start. If the value
//exceeds the larger of the absolute (-13 dBm) and relative (-10 dBc) start
//values, the check fails.
ESP:RANG2:LIM1:REL:STAR:FUNC MAX
ESP:RANG2:LIM1:REL:STAR -10
ESP:RANG2:LIM1:REL:STAR:ABS -13
ESP:RANG2:LIM1:REL:STOP:FUNC MAX
ESP:RANG2:LIM1:REL:STOP -10
ESP:RANG2:LIM1:REL:STOP:ABS -13

//Check the absolute and relative limits for all ranges in power class 2 and
//fails if either limit is violated. Since power class 2 is set to be used for
//the entire measurement, values for Limit Check 1 are irrelevant.
ESP:RANG:LIM2:STAT OR
//Define an absolute limit of 10 dBm for the entire range 2 for power class 2.
ESP:RANG2:LIM2:ABS:STAR 10
ESP:RANG2:LIM2:ABS:STOP 10
//Define a relative limit of -20 dBc for the entire range 2 for power class 2.
ESP:RANG2:LIM2:REL:STAR -20
ESP:RANG2:LIM2:REL:STOP -20

//----- Configuring List Evaluation-----
//Activate list evaluation, i.e. the peak is determined for each range
//after each sweep.
CALC:ESP:PSE:AUTO ON
//Define a peak threshold of 10 dB.
CALC:ESP:PSE:MARG 10dB

//----- Managing Measurement Configurations-----

//Save the current configuration in a new file named '3GPP_UL_User'
//in the same directory so the standard is not overwritten.
ESP:PRES:STOR 'WCDMA\3GPP\UL\3GPP_UL_User.xml'

//----- Performing the measurement-----
//One sweep

```

```

INIT:ESP

//----- Checking the Results-----
//Query the result of the limit check for all ranges.
CALC:LIM:FAIL?
//Query the peak for each range of the SEM measurement as a list.
TRAC:DATA? LIST

```

## 9.6.7 Measuring Spurious Emissions

The following commands are required to perform spurious emissions measurements.

- [Initializing the Measurement](#)..... 645
- [Configuring a Sweep List](#)..... 645
- [Configuring the List Evaluation](#)..... 651
- [Adjusting the X-Axis to the Range Definitions](#).....653
- [Performing a Spurious Measurement](#)..... 653
- [Retrieving and Saving Settings and Results](#).....654
- [Programming Example: Spurious Emissions Measurement](#).....654

### 9.6.7.1 Initializing the Measurement

Note that with the R&S FPL1000, the spurious measurement must be initialized before you can start configuring the sweep list or list evaluation.

[INITiate<n>:SPURious](#).....645

---

#### INITiate<n>:SPURious

This command initiates a Spurious Emission measurement.

#### Suffix:

<n>

### 9.6.7.2 Configuring a Sweep List

The following commands configure the sweep list for spurious emission measurements.



The sweep list cannot be configured using remote commands during an on-going sweep operation.

Useful commands for configuring the sweep described elsewhere:

- [\[SENSe:\]SWEep:MODE](#) on page 618
- [\[SENSe:\]LIST:RANGe<ri>\[:FREQuency\]:START](#) on page 622
- [\[SENSe:\]LIST:RANGe<ri>\[:FREQuency\]:STOP](#) on page 623

**Remote commands exclusive to spurious measurements:**

|                                                    |     |
|----------------------------------------------------|-----|
| [SENSe:]LIST:RANGe<ri>:BANDwidth:RESolution.....   | 646 |
| [SENSe:]LIST:RANGe<ri>:BANDwidth:VIDeo.....        | 646 |
| [SENSe:]LIST:RANGe<ri>:BREak.....                  | 647 |
| [SENSe:]LIST:RANGe<ri>:COUNT?.....                 | 647 |
| [SENSe:]LIST:RANGe<ri>:DELete.....                 | 647 |
| [SENSe:]LIST:RANGe<ri>:DETector.....               | 647 |
| [SENSe:]LIST:RANGe<ri>:FILTer:TYPE.....            | 647 |
| [SENSe:]LIST:RANGe<ri>:INPut:ATTenuation.....      | 648 |
| [SENSe:]LIST:RANGe<ri>:INPut:ATTenuation:AUTO..... | 648 |
| [SENSe:]LIST:RANGe<ri>:INPut:GAIN:STATe.....       | 648 |
| [SENSe:]LIST:RANGe<ri>:INPut:GAIN[:VALue].....     | 649 |
| [SENSe:]LIST:RANGe<ri>:LIMit:START.....            | 649 |
| [SENSe:]LIST:RANGe<ri>:LIMit:STATe.....            | 649 |
| [SENSe:]LIST:RANGe<ri>:LIMit:STOP.....             | 649 |
| [SENSe:]LIST:RANGe<ri>:POINts[:VALue].....         | 650 |
| [SENSe:]LIST:RANGe<ri>:RLEVel.....                 | 650 |
| [SENSe:]LIST:RANGe<ri>:SWEep:TIME.....             | 650 |
| [SENSe:]LIST:RANGe<ri>:SWEep:TIME:AUTO.....        | 650 |
| [SENSe:]LIST:RANGe<ri>:TRANsducer.....             | 651 |

**[SENSe:]LIST:RANGe<ri>:BANDwidth:RESolution <RBW>**

This command defines the resolution bandwidth for a spurious emission measurement range.

**Suffix:**

<ri> 1..n  
Selects the measurement range.

**Parameters:**

<RBW> Resolution bandwidth.  
Refer to the data sheet for available resolution bandwidths.  
Default unit: Hz

**Manual operation:** See " [RBW](#) " on page 340

**[SENSe:]LIST:RANGe<ri>:BANDwidth:VIDeo <VBW>**

This command defines the video bandwidth for a spurious emission measurement range.

**Suffix:**

<ri> 1..n  
Selects the measurement range.

**Parameters:**

<VBW> Video bandwidth.  
Refer to the data sheet for available video bandwidths.  
Default unit: Hz

**Manual operation:** See " [VBW](#) " on page 340

---

**[SENSe:]LIST:RANGe<ri>:BREak <State>**

This command controls the sweep (for all ranges, <range> is irrelevant).

**Suffix:**

<ri> irrelevant

**Parameters:**

<State>

**ON | 1**

The R&S FPL1000 stops after measuring one range. To continue with the next range, you have to use [INITiate<n>:CONMeas](#).

**OFF | 0**

The R&S FPL1000 sweeps all ranges in one go.

\*RST: 0

---

**[SENSe:]LIST:RANGe<ri>:COUNT?**

This command queries the number of ranges in the sweep list (<range> is irrelevant).

**Suffix:**

<ri> Selects the measurement range.

**Return values:**

<Ranges> Number of ranges in the sweep list.

**Usage:**

Query only

---

**[SENSe:]LIST:RANGe<ri>:DELeTe**

This command removes a range from the sweep list.

Note that

- you cannot delete the reference range
- a minimum of three ranges is mandatory.

**Suffix:**

<ri> 1..n  
Selects the measurement range.

---

**[SENSe:]LIST:RANGe<ri>:DETector <Detector>**

This command selects the detector for a spurious emission measurement range.

**Suffix:**

<ri> 1..n  
Selects the measurement range.

**Manual operation:** See "[Detector](#)" on page 341

---

**[SENSe:]LIST:RANGe<ri>:FILTer:TYPE <FilterType>**

This command selects the filter type for a spurious emission measurement range.

**Suffix:**

<ri> 1..30  
Selects the measurement range.

**Manual operation:** See " [Filter Type](#) " on page 340

**[SENSe:]LIST:RANGe<ri>:INPut:ATTenuation <Attenuation>**

This command defines the input attenuation for a spurious emission measurement range.

**Suffix:**

<ri> 1..n  
Selects the measurement range.

**Parameters:**

<Attenuation> Numeric value.  
Refer to the data sheet for the attenuation range.  
\*RST: 10 dB  
Default unit: dB

**Manual operation:** See " [RF Attenuation](#) " on page 341

**[SENSe:]LIST:RANGe<ri>:INPut:ATTenuation:AUTO <State>**

This command turns automatic selection of the input attenuation for a spurious emission measurement range on and off.

**Suffix:**

<ri> 1..n  
Selects the measurement range.

**Parameters:**

<State> ON | OFF | 0 | 1  
\*RST: 1

**Manual operation:** See " [RF Attenuation Mode](#) " on page 341

**[SENSe:]LIST:RANGe<ri>:INPut:GAIN:STATe <State>**

This command turns the preamplifier for a spurious emission measurement range on and off.

**Suffix:**

<ri> 1..n  
Selects the measurement range.

**Parameters:**

<State> ON | OFF | 1 | 0  
\*RST: 0

**Manual operation:** See " [Preamp](#) " on page 341



---

**[SENSe:]LIST:RANGe<ri>:INPut:GAIN[:VALue] <Gain>**

This command selects the preamplification level for the range.

**Suffix:**

<ri> 1..n  
Selects the measurement range.

---

**[SENSe:]LIST:RANGe<ri>:LIMit:STARt <Level>**

This command defines an absolute limit for a spurious emission measurement range.

**Suffix:**

<ri> 1..n  
Selects the measurement range.

**Parameters:**

<Level> Absolute limit at the start frequency of a SEM range.  
Range: -400 to 400  
\*RST: 13  
Default unit: dBm

**Manual operation:** See "[Abs Limit Start / Abs Limit Stop](#)" on page 342

---

**[SENSe:]LIST:RANGe<ri>:LIMit:STATe <State>**

This command turns the limit check for all spurious emission measurement ranges on and off.

**Suffix:**

<ri> irrelevant

**Parameters:**

<State> ON | OFF | 1 | 0  
\*RST: 0

**Manual operation:** See "[Limit Check](#)" on page 342

---

**[SENSe:]LIST:RANGe<ri>:LIMit:STOP <Level>**

This command defines an absolute limit for a spurious emission measurement range.

**Suffix:**

<ri> 1..n  
Selects the measurement range.

**Parameters:**

<Level> Absolute limit at the stop frequency of a SEM range.  
Range: -400 to 400  
\*RST: 13  
Default unit: dBm

**Manual operation:** See "[Abs Limit Start / Abs Limit Stop](#)" on page 342

---

**[SENSe:]LIST:RANGe<ri>:POINTs[:VALue] <Points>**

This command defines the number of sweep points in a spurious emission measurement range.

**Suffix:**

<ri> 1..n  
Selects the measurement range.

**Parameters:**

<Points> For more information on sweep points see [Chapter 8.6.1.8, "How Much Data is Measured: Sweep Points and Sweep Count"](#), on page 439.

\*RST: 1001

**Manual operation:** See "[Sweep Points](#)" on page 341

---

**[SENSe:]LIST:RANGe<ri>:RLEVel <RefLevel>**

This command defines the reference level for a spurious emission measurement range.

**Suffix:**

<ri> 1..n  
Selects the measurement range.

**Parameters:**

<RefLevel> Reference level.  
Refer to the data sheet for the reference level range.

\*RST: 0 dBm

Default unit: dBm

**Manual operation:** See "[Reference Level](#)" on page 341

---

**[SENSe:]LIST:RANGe<ri>:SWEep:TIME <SweepTime>**

This command defines the sweep time for a spurious emission measurement range.

**Suffix:**

<ri> 1..n  
Selects the measurement range.

**Parameters:**

<SweepTime> Sweep time.  
The range depends on the ratios of the span to the RBW and the RBW to the VBW. Refer to the data sheet for more information.

**Manual operation:** See "[Sweep Time](#)" on page 340

---

**[SENSe:]LIST:RANGe<ri>:SWEep:TIME:AUTO <State>**

This command turns automatic selection of the sweep time for a spurious emission measurement range on and off.

**Suffix:**

<ri> 1..n  
Selects the measurement range.

**Parameters:**

<State> ON | OFF | 0 | 1  
\*RST: 1

**Manual operation:** See " [Sweep Time Mode](#) " on page 340

---

**[SENSe:]LIST:RANGe<ri>:TRANsdUCer <Transducer>**

This command selects a transducer factor for a spurious emission measurement range.

Note that

- the transducer must cover at least the span of the range
- the x-axis has to be linear
- the unit has to be dB

**Suffix:**

<ri> 1..n  
Selects the measurement range.

**Parameters:**

<Transducer> String containing the transducer file name, including the path information.

**Manual operation:** See " [Transducer](#) " on page 342

### 9.6.7.3 Configuring the List Evaluation

The following commands configure the list evaluation.

#### Useful commands for spurious emission measurements described elsewhere

- [MMEMory:STORe<n>:LIST](#) on page 887

#### Remote commands exclusive to spurious emission measurements

|                                                                       |     |
|-----------------------------------------------------------------------|-----|
| <a href="#">CALCulate&lt;n&gt;:ESpectrum:PSEarch:DEtails</a> .....    | 652 |
| <a href="#">CALCulate&lt;n&gt;:ESpectrum:PEAKsearch:DEtails</a> ..... | 652 |
| <a href="#">CALCulate&lt;n&gt;:PSEarch:AUTO</a> .....                 | 652 |
| <a href="#">CALCulate&lt;n&gt;:PEAKsearch:AUTO</a> .....              | 652 |
| <a href="#">CALCulate&lt;n&gt;:PSEarch:MARGin</a> .....               | 652 |
| <a href="#">CALCulate&lt;n&gt;:PEAKsearch:MARGin</a> .....            | 652 |
| <a href="#">CALCulate&lt;n&gt;:PSEarch:PSHow</a> .....                | 653 |
| <a href="#">CALCulate&lt;n&gt;:PEAKsearch:PSHow</a> .....             | 653 |
| <a href="#">CALCulate&lt;n&gt;:PSEarch:SUBRanges</a> .....            | 653 |
| <a href="#">CALCulate&lt;n&gt;:PEAKsearch:SUBRanges</a> .....         | 653 |

---

**CALCulate<n>:ESpectrum:PSEarch:DEtails <State>**

**CALCulate<n>:ESpectrum:PEAKsearch:DEtails <State>**

This command configures how detailed the list in the Result Summary is.

**Suffix:**

<n> [Window](#)

**Parameters:**

<State> ON | OFF | 1 | 0

**ON | 1**

Includes all detected peaks (up to a maximum defined by [CALCulate<n>:PEAKsearch:SUBRanges](#) on page 653).

**OFF | 0**

Includes only one peak per range.

\*RST: 0

**Example:**

CALC:ESP:PSE:DET ON

CALC:PSE:SUBR 10

Includes up to 10 peaks per range in the list.

**Manual operation:** See " [Details](#) " on page 344

---

**CALCulate<n>:PSEarch:AUTO <State>**

**CALCulate<n>:PEAKsearch:AUTO <State>**

This command turns the list evaluation

on and off.

**Suffix:**

<n> [Window](#)

**Parameters:**

<State> ON | OFF | 0 | 1

\*RST: 1

**Example:**

CALC:PSE:AUTO OFF

Deactivates the list evaluation.

---

**CALCulate<n>:PSEarch:MARGin <Threshold>**

**CALCulate<n>:PEAKsearch:MARGin <Margin>**

This command defines the threshold of the list evaluation.

**Suffix:**

<n> [Window](#)

**Parameters:**

<Margin> Range: -200 to 200  
Default unit: dB

**Example:**

CALC:PSE:MARG 100

Sets the threshold to 100 dB.

---

**CALCulate<n>:PSEarch:PSHow <State>**

**CALCulate<n>:PEAKsearch:PSHow <State>**

This command turns the peak labels in the diagram on and off.

Peak labels are blue squares.

**Suffix:**

<n> [Window](#)

**Parameters:**

<State> ON | OFF | 1 | 0  
\*RST: 0

**Example:**

CALC:PSE:PSH ON  
Marks all peaks with blue squares.

---

**CALCulate<n>:PSEarch:SUBRanges <NumberPeaks>**

**CALCulate<n>:PEAKsearch:SUBRanges <NumberPeaks>**

This command defines the number of peaks included in the peak list.

After this number of peaks has been found, the R&S FPL1000 stops the peak search and continues the search in the next measurement range.

**Suffix:**

<n> [Window](#)

**Parameters:**

<NumberPeaks> Range: 1 to 50  
\*RST: 25

**Example:**

CALC:PSE:SUBR 10  
Sets 10 peaks per range to be stored in the list.

**Manual operation:** See "[Peaks per Range](#)" on page 344

#### 9.6.7.4 Adjusting the X-Axis to the Range Definitions

---

**[SENSe:]LIST:XADJust**

Sets the x-axis range for the spurious emission measurement from the start frequency of the first sweep range to the stop frequency of the last sweep range.

**Example:** SENS:LIST:XADJ

**Usage:** Event

#### 9.6.7.5 Performing a Spurious Measurement

The following commands are required to perform a Spurious measurement:

SENS:SWE:MODE LIST, see [\[SENSe:\]SWEep:MODE](#) on page 618

[INITiate<n>\[:IMMEDIATE\]](#) on page 590, see [Chapter 9.6.1, "Performing Measurements"](#), on page 588

### 9.6.7.6 Retrieving and Saving Settings and Results

The following commands analyze and retrieve measurement results for Spurious measurements.

#### Useful commands for spurious emission measurements described elsewhere

- [CALCulate<n>:LIMIT<li>:FAIL?](#) on page 858
- [TRACe<n>\[:DATA\]](#) on page 776
- [TRACe<n>\[:DATA\]:MEMory?](#) on page 778
- [TRACe<n>\[:DATA\]:X?](#) on page 778

### 9.6.7.7 Programming Example: Spurious Emissions Measurement

In the following example, the Spurious Emissions measurement is configured by defining ranges and parameters to create the following sweep list.

Note that this example is primarily meant to demonstrate the remote control commands, it does not necessarily reflect a useful measurement task.

```
//-----Preparing the measurement-----
*RST
//Resets the instrument

SWE:MODE LIST
//Activates spurious emissions measurement

INIT:CONT OFF
//Selects single sweep mode.

//Spurious measurement has to be in single sweep mode to be configured
//and no sweep operation may be running!

// If required, a sweep stop can be ensured by INIT:IMM;*WAI

//-----Configuring a Sweep List-----

LIST:RANG:COUNT?
//Returns the number of measurement ranges in the sweep list.
LIST:RANG4:DEL
//Deletes the fourth range.
LIST:RANG1:STAR 10000000
//Defines a start frequency of 10 MHz for range 1.
LIST:RANG1:STOP 100000000
//Defines a stop frequency of 100 MHz for range 1.
LIST:RANG1:BAND 500000
```

## Configuring and Performing Measurements

```

//Defines a resolution bandwidth of 500 kHz in range 1.
LIST:RANG1:BAND:VID 5000000
//Defines a video bandwidth of 5 MHz for range 1.
LIST:RANG1:INP:ATT:AUTO OFF
//Turns automatic selection of the input attenuation in range 1 off.

LIST:RANG1:INP:ATT 10
//Defines a input attenuation of 10 dBm for range 1.

LIST:RANG1:FILT:TYPE CFILter
//Selects an Channel filter for range 1.
LIST:RANG1:DET SAMP
//Selects a sample detector for range 1.
LIST:RANG1:POIN 601
//Defines 601 sweep points for range 1.
LIST:RANG1:RLEV -20
//Defines a reference level of -20 dBm for range 1.
LIST:RANG1:SWE:TIME 5
//Defines a manual sweep time of 5 second for range 1.

// Create a transducer that can be used.
// It has to cover the corresponding frequency range
//
SENSE1:CORREction:TRANsdUCer:SElect 'Test'
SENSE1:CORREction:TRANsdUCer:UNIT 'DB'
SENSE1:CORREction:TRANsdUCer:COMment 'Test Transducer'
// Frequency Span 0 MHz to 20 Ghz
SENSE1:CORREction:TRANsdUCer:DATA 0e6,5, 20e9,3

SENS:LIST:RANG1:TRAN 'Test'
//Includes a transducer called 'Test' for range 1.

LIST:RANG1:LIM:STAR 10
LIST:RANG1:LIM:STOP 10
//Defines an absolute limit of 10 dBm at the start and stop frequencies of range 1.
LIST:RANG:LIM:STAT ON
//Turns the limit check for all ranges on.

//-----Configuring the List Evaluation-----
CALC:PSE:MARG 100
//Sets the threshold to 100 dB.
CALC:PSE:PSH ON
//Marks all peaks in the diagram with blue squares.
CALC:PSE:SUBR 10
//Sets 10 peaks per range to be stored in the list.

//-----Performing the Measurement-----

INIT:SPUR; *WAI

```

```
//Performs a spurious emission measurement and waits until the sweep has finished.

//-----Retrieving Results-----
CALC:LIM1:FAIL?
//Queries the result of the check for limit line 1.
TRAC? SPUR
//Queries the peak list of the spurious emission measurement.
```

## 9.6.8 Analyzing Statistics (APD, CCDF)

All remote control commands specific to statistical measurements are described here.

- [Activating Statistical Measurements](#)..... 656
- [Configuring Statistical Measurements](#).....657
- [Using Gate Ranges for Statistical Measurements](#)..... 658
- [Scaling the Diagram](#).....660
- [Performing a Statistical Measurement](#)..... 662
- [Retrieving Results](#).....662
- [Programming Example: Measuring Statistics](#)..... 664

### 9.6.8.1 Activating Statistical Measurements

The following commands activate statistical measurements.

```
CALCulate<n>:STATistics:APD[:STATe].....656
CALCulate<n>:STATistics:CCDF[:STATe]..... 656
```

---

#### CALCulate<n>:STATistics:APD[:STATe] <State>

This command turns the APD measurement on and off.

**Suffix:**

<n>                      [Window](#)

**Parameters:**

<State>                      ON | OFF | 1 | 0  
 \*RST:                      0

**Example:**

```
CALC:STAT:APD ON
Switches on the APD measurement.
```

---

#### CALCulate<n>:STATistics:CCDF[:STATe] <State>

This command turns the CCDF on and off.

**Suffix:**

<n>                      irrelevant

**Parameters:**

<State>                      ON | OFF | 1 | 0  
 \*RST:                      0



**Example:**            `CALC:STAT:CCDF ON`  
Switches on the CCDF measurement.

### 9.6.8.2 Configuring Statistical Measurements

The following commands configure the measurement.

Useful commands for configuring statistical measurements described elsewhere:

- `[SENSe:]BANDwidth[:RESolution]` on page 722
- `DISPlay[:WINDow<n>]:TRACe<t>:Y[:SCALE]:RLEVEL` on page 730  
(Make sure the specified reference level is higher than the measured peak value, see `CALCulate<n>:MARKer<m>:Y` on page 803).

#### Remote commands exclusive to statistical measurements:

|                                                                 |     |
|-----------------------------------------------------------------|-----|
| <code>CALCulate&lt;n&gt;:MARKer&lt;m&gt;:Y:PERCent</code> ..... | 657 |
| <code>CALCulate&lt;n&gt;:STATistics:NSAMples</code> .....       | 657 |

---

#### `CALCulate<n>:MARKer<m>:Y:PERCent <Probability>`

This command sets a marker to a particular probability value. You can query the corresponding level with `CALCulate<n>:MARKer<m>:X`.

Using the command turns delta markers into normal markers.

#### Suffix:

<n>                    [Window](#)

<m>                    [Marker](#)

#### Parameters:

<Probability>        Range:        0 % to 100 %  
Default unit: %

**Example:**            `CALC1:MARK:Y:PERC 95PCT`  
Positions marker 1 to a probability of 95 %.

**Manual operation:** See "[Percent Marker \(CCDF only\)](#)" on page 352

---

#### `CALCulate<n>:STATistics:NSAMples <Samples>`

This command defines the number of samples included in the analysis of statistical measurement functions.

#### Suffix:

<n>                    [Window](#)

#### Parameters:

<Samples>            Range:        Min: 100, Max: depends on the RBW filter  
\*RST:            100000

**Example:**            `CALC:STAT:NSAM 500`  
Sets the number of measurement points to be acquired to 500.

**Manual operation:** See "[Number of Samples](#)" on page 352

### 9.6.8.3 Using Gate Ranges for Statistical Measurements

The following commands control gated statistical measurements.

|                                               |     |
|-----------------------------------------------|-----|
| [SENSe:]SWEep:EGATe:TRACe<t>:COMMeNt.....     | 658 |
| [SENSe:]SWEep:EGATe:TRACe<t>:PERiod.....      | 658 |
| [SENSe:]SWEep:EGATe:TRACe<t>:STARt<gr>.....   | 658 |
| [SENSe:]SWEep:EGATe:TRACe<t>[:STATe<gr>]..... | 659 |
| [SENSe:]SWEep:EGATe:TRACe<t>:STOP<gr>.....    | 659 |

---

#### [SENSe:]SWEep:EGATe:TRACe<t>:COMMeNt <Comment>

This command defines a comment for the gate of a particular trace.

**Suffix:**

<t>                      Trace

**Parameters:**

<Comment>              String containing the comment.

**Example:**

SWE:EGAT:TRAC1:COMM 'MyComment'  
Defines a comment for the gate in trace 1.

**Manual operation:** See " [Comment](#) " on page 354

---

#### [SENSe:]SWEep:EGATe:TRACe<t>:PERiod <Length>

This command defines the length of the gate for all traces.

The gate length applies to all traces.

**Suffix:**

<t>                      irrelevant

**Parameters:**

<Length>                Range:        100 ns to 1000 s  
                             \*RST:        2 ms  
                             Default unit: s

**Example:**

SWE:EGAT:TRAC:PER 5ms  
Defines the period for gated triggering to 5 ms.

**Manual operation:** See " [Period](#) " on page 354

---

#### [SENSe:]SWEep:EGATe:TRACe<t>:STARt<gr> <Time>

This command defines the start time for a gate range.

**Suffix:**

<t>                      Trace

<gr>                     1..n  
                             gate range

**Parameters:**

<Time>

The value range depends on the gate period you have set for the selected trace with `[SENSe:]SWEep:EGATe:TRACe<t>:PERiod`. The following rules apply:

- the start time may not be higher than the length of the gate
- the start time may not be lower than the stop time of the gate range of a lower order

The reset values depend on the gate range.

- for gate range 1, the start time is 0 ms
- for gate range 3, the start time is 2 ms
- for gate range 5, the start time is 4 ms

Default unit: s

**Example:** `SWE:EGAT:TRAC1:STAR1 3ms`  
Sets the Starting point for range 1 on trace 1 at 3 ms.

**Manual operation:** See " [Range <x> Start/Stop](#) " on page 354

**[SENSe:]SWEep:EGATe:TRACe<t>[:STATe<gr>] <State>**

This command includes or excludes a gate range for a particular trace.

**Suffix:**

<t> [Trace](#)  
<gr> gate range

**Parameters:**

<State> ON | OFF | 0 | 1  
**OFF | 0**  
Switches the function off  
**ON | 1**  
Switches the function on

**Example:** `SWE:EGAT:TRAC1:STAT1 ON`  
Activates gate range 1 for trace 1.

**Manual operation:** See " [Gated Trigger](#) " on page 353  
See " [Range <x> Use](#) " on page 354

**[SENSe:]SWEep:EGATe:TRACe<t>:STOP<gr> <Time>**

This command defines the stop time for a gate range.

**Suffix:**

<t> [Trace](#)  
<gr> 1..n  
gate range

**Parameters:**

<Time> The value range depends on the gate period you have set for the selected trace with `[SENSe:]SWEep:EGATe:TRACe<t>:PERiod`. The following rules apply:

- the stop time may not be higher than the length of the gate
- the stop time may not be lower than the start time

The reset values depend on the gate range.

- for gate range 1, the stop time is 1 ms
- for gate range 3, the stop time is 3 ms
- for gate range 5, the stop time is 5 ms

Default unit: s

**Example:** `SWE:EGAT:TRAC1:STOP1 5ms`  
Sets the stopping point for range 1 on trace 1 at 5 ms.

**Manual operation:** See " [Range <x> Start/Stop](#) " on page 354

#### 9.6.8.4 Scaling the Diagram

The following commands set up the diagram for statistical measurements.

|                                                                  |     |
|------------------------------------------------------------------|-----|
| <code>CALCulate&lt;n&gt;:STATistics:PRESet</code> .....          | 660 |
| <code>CALCulate&lt;n&gt;:STATistics:SCALE:AUTO ONCE</code> ..... | 660 |
| <code>CALCulate&lt;n&gt;:STATistics:SCALE:X:RANGe</code> .....   | 661 |
| <code>CALCulate&lt;n&gt;:STATistics:SCALE:X:RLEVel</code> .....  | 661 |
| <code>CALCulate&lt;n&gt;:STATistics:SCALE:Y:LOWer</code> .....   | 661 |
| <code>CALCulate&lt;n&gt;:STATistics:SCALE:Y:UNIT</code> .....    | 662 |
| <code>CALCulate&lt;n&gt;:STATistics:SCALE:Y:UPPer</code> .....   | 662 |

---

#### `CALCulate<n>:STATistics:PRESet`

This command resets the scale of the diagram (x- and y-axis).

- Reference level (x-axis)  
0.0 dBm
- Display range (x-axis) for APD measurements  
100 dB
- Display range (x-axis) for CCDF measurements  
20 dB
- Upper limit of the y-axis  
1.0
- Lower limit of the y-axis  
1E-6

#### **Suffix:**

<n> [Window](#)

**Example:** `CALC:STAT:PRESet`  
Resets the scaling for statistical functions

**Manual operation:** See " [Default Settings](#) " on page 356

---

#### `CALCulate<n>:STATistics:SCALE:AUTO ONCE`

This command initiates an automatic scaling of the diagram (x- and y-axis).

To obtain maximum resolution, the level range is set as a function of the measured spacing between peak power and the minimum power for the APD measurement and of the spacing between peak power and mean power for the CCDF measurement. In addition, the probability scale for the number of test points is adapted.

To get valid results, you have to perform a complete sweep with synchronization to the end of the auto range process. This is only possible in single sweep mode.

**Suffix:**

<n> [Window](#)

**Manual operation:** See "[Adjust Settings](#)" on page 353

**CALCulate<n>:STATistics:SCALE:X:RANGE <Range>**

This command defines the display range of the x-axis for statistical measurements.

The effects are identical to `DISPlay[:WINDow<n>]:TRACe<t>:Y[:SCALE]`.

**Suffix:**

<n> [Window](#)

**Parameters:**

<Range>            Range:        1 dB to 200 dB  
                      \*RST:        100 dB  
                      Default unit: dB

**Example:**            `CALC:STAT:SCAL:X:RANG 20dB`

**Manual operation:** See "[Range](#)" on page 356

**CALCulate<n>:STATistics:SCALE:X:RLEVEL <RefLevel>**

This command sets the reference level for statistical measurements. The effects are identical to `DISPlay[:WINDow<n>]:TRACe<t>:Y[:SCALE]:RLEVEL`.

Note that in case of statistical measurements the reference level applies to the x-axis.

**Suffix:**

<n> [Window](#)

**Parameters:**

<RefLevel>            The unit is variable.  
                      If a reference level offset is included, the range is adjusted by that offset.  
                      Range:        -130 dBm to 30 dBm  
                      \*RST:        0 dBm  
                      Default unit: dBm

**Example:**            `CALC:STAT:SCAL:X:RLEV -60dBm`

**Manual operation:** See "[Ref Level](#)" on page 356

**CALCulate<n>:STATistics:SCALE:Y:LOWer <Magnitude>**

This command defines the lower vertical limit of the diagram.

**Suffix:**  
 <n> [Window](#)

**Parameters:**  
 <Magnitude> The number is a statistical value and therefore dimensionless.  
 Range: 1E-9 to 0.1  
 \*RST: 1E-6

**Example:** `CALC:STAT:SCAL:Y:LOW 0.001`

**Manual operation:** See " [Y-Max / Y-Min](#) " on page 356

#### **CALCulate<n>:STATistics:SCALe:Y:UNIT <Unit>**

This command selects the unit of the y-axis.

**Suffix:**  
 <n> [Window](#)

**Parameters:**  
 <Unit> PCT | ABS  
 \*RST: ABS

**Example:** `CALC:STAT:SCAL:Y:UNIT PCT`  
 Sets the percentage scale.

**Manual operation:** See " [Y-Unit](#) " on page 356

#### **CALCulate<n>:STATistics:SCALe:Y:UPPer <Magnitude>**

This command defines the upper vertical limit of the diagram.

**Suffix:**  
 <n> [Window](#)

**Parameters:**  
 <Magnitude> The number is a statistical value and therefore dimensionless.  
 Range: 1E-5 to 1.0  
 \*RST: 1.0

**Example:** `CALC:STAT:SCAL:Y:UPP 0.01`

**Manual operation:** See " [Y-Max / Y-Min](#) " on page 356

### 9.6.8.5 Performing a Statistical Measurement

The following commands are required to perform a statistical measurement:

`INITiate<n>[:IMMediate]` on page 590, see [Chapter 9.6.1, "Performing Measurements"](#), on page 588

### 9.6.8.6 Retrieving Results

The following commands are required to retrieve the measurement results.

Useful commands for retrieving results described elsewhere:

- [CALCulate<n>:MARKer<m>:X](#) on page 789

### Remote commands exclusive to statistical results

|                                                                        |     |
|------------------------------------------------------------------------|-----|
| <a href="#">CALCulate&lt;n&gt;:STATistics:CCDF:X&lt;t&gt;?</a> .....   | 663 |
| <a href="#">CALCulate&lt;n&gt;:STATistics:RESult&lt;res&gt;?</a> ..... | 663 |

---

### **CALCulate<n>:STATistics:CCDF:X<t>? <Probability>**

This command queries the results of the CCDF.

#### Suffix:

<n>                    [Window](#)

<t>                    [Trace](#)

#### Query parameters:

<Probability>        **P0\_01**  
                           Level value for 0.01 % probability

**P0\_1**  
                           Level value for 0.1 % probability

**P1**  
                           P1: Level value for 1 % probability

**P10**  
                           Level value for 10 % probability

#### Return values:

<CCDF Result>

#### Example:

`CALC:STAT:CCDF:X1? P10`

Returns the level values that are over 10 % above the mean value.

#### Usage:

Query only

---

### **CALCulate<n>:STATistics:RESult<res>? <ResultType>**

This command queries the results of a CCDF or ADP measurement for a specific trace.

#### Suffix:

<n>                    irrelevant

<res>                [Trace](#)

#### Query parameters:

<ResultType>        **MEAN**  
                           Average (=RMS) power in dBm measured during the measurement time.

**PEAK**  
                           Peak power in dBm measured during the measurement time.

**CFACTOR**

Determined crest factor (= ratio of peak power to average power) in dB.

**ALL**

Results of all three measurements mentioned before, separated by commas: <mean power>,<peak power>,<crest factor>

**Example:**

```
CALC:STAT:RES2? ALL
```

Reads out the three measurement results of trace 2. Example of answer string: 5.56,19.25,13.69 i.e. mean power: 5.56 dBm, peak power 19.25 dBm, crest factor 13.69 dB

**Usage:**

Query only

**9.6.8.7 Programming Example: Measuring Statistics**

This example demonstrates how to determine statistical values for a measurement in a remote environment using the gated statistics example described in [Chapter 8.2.8.4, "APD and CCDF Basics - Gated Triggering"](#), on page 350.

```
//-----Configuring the measurement -----
*RST
//Reset the instrument
TRIG:SOUR EXT
//Defines the use of an external trigger.
TRIG:HOLD 25us
//Defines a trigger offset of 25 µs.
CALC:STAT:APD ON
//Activates APD measurement.
CALC:STAT:NSAM 1000
//Sets the number of samples to be included in the statistical evaluation to 1000.

//-----Defining Gate ranges -----

SWE:EGAT:TRAC1:COMM 'GSM - useful part'
//Defines a comment for the gate
SWE:EGAT:TRAC1:PER 4.61536ms
//Sets the gate period to 4.61536ms.
SWE:EGAT:TRAC1:STAR1 15us
//Sets the start of range 1 to 15 µs.
SWE:EGAT:TRAC1:STOP1 557.8us
//Sets the end of range 1 to 15 µs (start time) + 542.77 µs (useful part) = 557.8 µs.
SWE:EGAT:TRAC1:STAT1 ON
//Activates the use of range 1.

//-----Performing the Measurement-----
INIT:CONT OFF
//Selects single sweep mode.
INIT;*WAI
//Initiates a new measurement and waits until the sweep has finished.
```



```
//-----Retrieving Results-----
CALC:STAT:RES1? MEAN
//Returns the mean average power for the useful part of the GSM signal.

//----- Determining the CCDF values-----

CALC:STAT:CCDF ON
//Activates CCDF measurement.
CALC:MARK2:Y:PERC 95PCT
//Sets marker 2 to the 95% probability value.
INIT;*WAI
//Initiates a new measurement and waits until the sweep has finished.
CALC:STAT:CCDF:X? P1
//Returns the level value for 10% probability for the CCDF.
CALC:MARK2:X?
//Returns the level for a probability of 95%.

//----- Scaling the diagram -----
CALC:STAT:SCAL:X:RLEV -70dBm
//Sets the reference level to -70 dBm (x-axis!)
CALC:STAT:SCAL:X:RANG 20dB
//Defines a power level range of 20 dB for the x-axis
CALC:STAT:SCAL:Y:LOW 0.0001
//Sets the minimum of the y-axis to 0.01% probability
CALC:STAT:SCAL:Y:UPP 1.0
//Sets the maximum of the y-axis to 100% probability
CALC:STAT:SCAL:Y:UNIT PCT
//Displays percentage values on y-axis scale
```

## 9.6.9 Measuring the Time Domain Power

All remote control commands specific to time domain power measurements are described here.

- [Configuring the Measurement](#).....665
- [Performing a Time Domain Power Measurement](#)..... 668
- [Retrieving Measurement Results](#).....669
- [Programming Example: Time Domain Power](#)..... 673

### 9.6.9.1 Configuring the Measurement

The following remote commands measure the time domain power.

**Useful commands for time domain power measurements described elsewhere**

- `CALCulate<n>:MARKer<m>:X:SLIMits:LEFT`
- `CALCulate<n>:MARKer<m>:X:SLIMits:RIGHT`
- `CALCulate<n>:MARKer<m>:X:SLIMits[:STATe]`

**Remote commands exclusive to time domain power measurements**

|                                                                 |     |
|-----------------------------------------------------------------|-----|
| CALCulate<n>:MARKer<m>:FUNCTion:SUMMary:AOff.....               | 666 |
| CALCulate<n>:MARKer<m>:FUNCTion:SUMMary:AVERage.....            | 666 |
| CALCulate<n>:MARKer<m>:FUNCTion:SUMMary:PHOLd.....              | 667 |
| CALCulate<n>:MARKer<m>:FUNCTion:SUMMary[:STATe].....            | 667 |
| CALCulate<n>:MARKer<m>:FUNCTion:SUMMary:MEAN[:STATe].....       | 667 |
| CALCulate<n>:MARKer<m>:FUNCTion:SUMMary:PPEak[:STATe].....      | 668 |
| CALCulate<n>:MARKer<m>:FUNCTion:SUMMary:RMS[:STATe].....        | 668 |
| CALCulate<n>:MARKer<m>:FUNCTion:SUMMary:SDEViation[:STATe]..... | 668 |

**CALCulate<n>:MARKer<m>:FUNCTion:SUMMary:AOff**

This command turns all time domain power evaluation modes off.

**Suffix:**

|     |        |
|-----|--------|
| <n> | Window |
| <m> | Marker |

**CALCulate<n>:MARKer<m>:FUNCTion:SUMMary:AVERage <State>**

This command switches on or off averaging for the active power measurement in zero span in the window specified by the suffix <n>. If activated, a time domain value is calculated from the trace after each sweep; in the end, all values are averaged to calculate the final result.

The number of results required for the calculation of average is defined with [\[SENSe:\]AVERage<n>:COUNT](#).

Averaging is reset by switching it off and on again.

Synchronization to the end of averaging is only possible in single sweep mode.

**Suffix:**

|     |        |
|-----|--------|
| <n> | Window |
| <m> | Marker |

**Parameters:**

|         |                  |
|---------|------------------|
| <State> | ON   OFF   1   0 |
| *RST:   | 0                |

**Example:**

```
INIT:CONT OFF
Switches to single sweep mode.
CALC:MARK:FUNC:SUMM:AVER ON
Switches on the calculation of average.
AVER:COUN 200
Sets the measurement counter to 200.
INIT;*WAI
Starts a sweep and waits for the end.
```

**CALCulate<n>:MARKer<m>:FUNction:SUMMary:PHOLd <State>**

This command switches on or off the peak-hold function for the active power measurement in zero span in the window specified by the suffix <n>. If activated, the peak for each sweep is compared to the previously stored peak; the maximum of the two is stored as the current peak.

The peak-hold function is reset by switching it off and on again.

**Suffix:**

<n> [Window](#)

<m> [Marker](#)

**Parameters:**

<State> ON | OFF | 1 | 0

\*RST: 0

**CALCulate<n>:MARKer<m>:FUNction:SUMMary[:STATe] <State>**

This command turns time domain power measurements on and off. This measurement is only available in zero span.

When you turn the measurement on, the R&S FPL1000 activates a marker and positions it on the peak power level in the marker search range.

**Suffix:**

<n> [Window](#)

<m> [Marker](#)

**Parameters:**

<State> ON | OFF | 1 | 0

\*RST: 0

**CALCulate<n>:MARKer<m>:FUNction:SUMMary:MEAN[:STATe] <State>**

This command turns the evaluation to determine the mean time domain power on and off.

The R&S FPL1000 performs the measurement on the trace marker 1 is positioned on.

**Suffix:**

<n> [Window](#)

<m> [Marker](#)

**Parameters:**

<State> ON | OFF | 1 | 0

\*RST: 0

**Manual operation:** See "[Results](#)" on page 364

**CALCulate<n>:MARKer<m>:FUNction:SUMMary:PPEak[:STATe] <State>**

This command turns the evaluation to determine the positive peak time domain power on and off.

The R&S FPL1000 performs the measurement on the trace marker 1 is positioned on.

**Suffix:**

<n> [Window](#)

<m> [Marker](#)

**Parameters:**

<State> ON | OFF | 1 | 0

\*RST: 0

**Manual operation:** See "[Results](#)" on page 364

**CALCulate<n>:MARKer<m>:FUNction:SUMMary:RMS[:STATe] <State>**

This command turns the evaluation to determine the RMS time domain power on and off.

The R&S FPL1000 performs the measurement on the trace marker 1 is positioned on.

**Suffix:**

<n> [Window](#)

<m> [Marker](#)

**Parameters:**

<State> ON | OFF | 1 | 0

\*RST: 0

**Manual operation:** See "[Results](#)" on page 364

**CALCulate<n>:MARKer<m>:FUNction:SUMMary:SDEVIation[:STATe] <State>**

This command turns the evaluation to determine the standard deviation of the time domain power on and off.

The R&S FPL1000 performs the measurement on the trace marker 1 is positioned on.

**Suffix:**

<n> [Window](#)

<m> [Marker](#)

**Parameters:**

<State> ON | OFF | 1 | 0

\*RST: 0

### 9.6.9.2 Performing a Time Domain Power Measurement

The following commands are required to perform a Time Domain Power measurement:

[INITiate<n>\[:IMMediate\]](#) on page 590

See [Chapter 9.6.1, "Performing Measurements"](#), on page 588

### 9.6.9.3 Retrieving Measurement Results

The following commands query the results for time domain measurements.

#### Measuring the Mean Power

|                                                                                                |     |
|------------------------------------------------------------------------------------------------|-----|
| <a href="#">CALCulate&lt;n&gt;:MARKer&lt;m&gt;:FUNction:SUMMary:MEAN:AVERage:RESult?</a> ..... | 669 |
| <a href="#">CALCulate&lt;n&gt;:MARKer&lt;m&gt;:FUNction:SUMMary:MEAN:PHOLd:RESult?</a> .....   | 669 |
| <a href="#">CALCulate&lt;n&gt;:MARKer&lt;m&gt;:FUNction:SUMMary:MEAN:RESult?</a> .....         | 670 |

---

#### **CALCulate<n>:MARKer<m>:FUNction:SUMMary:MEAN:AVERage:RESult?**

This command queries the average mean time domain power. The query is only possible if averaging has been activated previously using [CALCulate<n>:MARKer<m>:FUNction:SUMMary:AVERage](#) on page 666.

To get a valid result, you have to perform a complete measurement with synchronization to the end of the measurement before reading out the result. This is only possible for single sweep mode.

See also [INITiate<n>:CONTInuous](#) on page 589.

#### Suffix:

<n>                      [Window](#)

<m>                      [Marker](#)

#### Return values:

<MeanPower>              Mean power of the signal during the measurement time.

**Usage:**                      Query only

---

#### **CALCulate<n>:MARKer<m>:FUNction:SUMMary:MEAN:PHOLd:RESult?**

This command queries the maximum mean time domain power. The query is only possible if the peak hold function has been activated previously using [CALCulate<n>:MARKer<m>:FUNction:SUMMary:PHOLd](#).

To get a valid result, you have to perform a complete measurement with synchronization to the end of the measurement before reading out the result. This is only possible for single sweep mode.

See also [INITiate<n>:CONTInuous](#) on page 589.

#### Suffix:

<n>                      [Window](#)

<m>                      [Marker](#)

#### Return values:

<MeanPower>              Mean power of the signal during the measurement time.

**Usage:** Query only

---

#### **CALCulate<n>:MARKer<m>:FUNCTION:SUMMARY:MEAN:RESult?**

This command queries the mean time domain power.

To get a valid result, you have to perform a complete measurement with synchronization to the end of the measurement before reading out the result. This is only possible for single sweep mode.

See also [INITiate<n>:CONTinuous](#) on page 589.

**Suffix:**

<n> [Window](#)

<m> [Marker](#)

**Return values:**

<MeanPower> Mean power of the signal during the measurement time.

**Usage:** Query only

**Manual operation:** See " [Results](#) " on page 364

### **Measuring the Peak Power**

---

#### **CALCulate<n>:MARKer<m>:FUNCTION:SUMMARY:PPEak:AVERage:RESult?**

This command queries the average positive peak time domain power. The query is only possible if averaging has been activated previously using [CALCulate<n>:MARKer<m>:FUNCTION:SUMMARY:AVERage](#) on page 666.

To get a valid result, you have to perform a complete measurement with synchronization to the end of the measurement before reading out the result. This is only possible for single sweep mode.

See also [INITiate<n>:CONTinuous](#) on page 589.

**Suffix:**

<n> [Window](#)

<m> [Marker](#)

**Return values:**

<PeakPower> Peak power of the signal during the measurement time.

**Usage:** Query only

---

#### **CALCulate<n>:MARKer<m>:FUNCTION:SUMMARY:PPEak:PHOLd:RESult?**

This command queries the maximum positive peak time domain power. The query is only possible if the peak hold function has been activated previously using [CALCulate<n>:MARKer<m>:FUNCTION:SUMMARY:PHOLd](#).

To get a valid result, you have to perform a complete measurement with synchronization to the end of the measurement before reading out the result. This is only possible for single sweep mode.

See also [INITiate<n>:CONTinuous](#) on page 589.

**Suffix:**

<n> [Window](#)

<m> [Marker](#)

**Return values:**

<PeakPower> Peak power of the signal during the measurement time.

**Usage:** Query only

**CALCulate<n>:MARKer<m>:FUNction:SUMMary:PPEak:RESult?**

This command queries the positive peak time domain power.

To get a valid result, you have to perform a complete measurement with synchronization to the end of the measurement before reading out the result. This is only possible for single sweep mode.

See also [INITiate<n>:CONTinuous](#) on page 589.

**Suffix:**

<n> [Window](#)

<m> [Marker](#)

**Return values:**

<PeakPower> Peak power of the signal during the measurement time.

**Usage:** Query only

**Manual operation:** See " [Results](#) " on page 364

**Measuring the RMS Power****CALCulate<n>:MARKer<m>:FUNction:SUMMary:RMS:AVERage:RESult?**

This command queries the average RMS of the time domain power. The query is only possible if averaging has been activated previously using [CALCulate<n>:MARKer<m>:FUNction:SUMMary:AVERage](#) on page 666.

To get a valid result, you have to perform a complete measurement with synchronization to the end of the measurement before reading out the result. This is only possible for single sweep mode.

See also [INITiate<n>:CONTinuous](#) on page 589.

**Suffix:**

<n> [Window](#)

<m> [Marker](#)

**Return values:**

<RMSPower> RMS power of the signal during the measurement time.

**Usage:** Query only

**CALCulate<n>:MARKer<m>:FUNction:SUMMary:RMS:PHOLd:RESult?**

This command queries the maximum RMS of the time domain power. The query is only possible if the peak hold function has been activated previously using [CALCulate<n>:MARKer<m>:FUNction:SUMMary:PHOLd](#).

To get a valid result, you have to perform a complete measurement with synchronization to the end of the measurement before reading out the result. This is only possible for single sweep mode.

See also [INITiate<n>:CONTInuous](#) on page 589.

**Suffix:**

<n> [Window](#)

<m> [Marker](#)

**Return values:**

<RMSPower> RMS power of the signal during the measurement time.

**Usage:** Query only

**CALCulate<n>:MARKer<m>:FUNction:SUMMary:RMS:RESult?**

This command queries the RMS of the time domain power.

To get a valid result, you have to perform a complete measurement with synchronization to the end of the measurement before reading out the result. This is only possible for single sweep mode.

See also [INITiate<n>:CONTInuous](#) on page 589.

**Suffix:**

<n> [Window](#)

<m> [Marker](#)

**Return values:**

<RMSPower> RMS power of the signal during the measurement time.

**Usage:** Query only

**Manual operation:** See "[Results](#)" on page 364

**Measuring the Standard Deviation****CALCulate<n>:MARKer<m>:FUNction:SUMMary:SDEViation:AVERage:RESult?**

This command queries the average standard deviation of the time domain power. The query is only possible if averaging has been activated previously using [CALCulate<n>:MARKer<m>:FUNction:SUMMary:AVERage](#) on page 666.

To get a valid result, you have to perform a complete measurement with synchronization to the end of the measurement before reading out the result. This is only possible for single sweep mode.

See also [INITiate<n>:CONTInuous](#) on page 589.



**Suffix:**<n> [Window](#)<m> [Marker](#)**Return values:**

&lt;StandardDeviation&gt; Standard deviation of the signal during the measurement time.

**Usage:** Query only

---

**CALCulate<n>:MARKer<m>:FUNction:SUMMary:SDEViation:PHOLd:RESult?**

This command queries the maximum standard deviation of the time domain power. The query is only possible if the peak hold function has been activated previously using [CALCulate<n>:MARKer<m>:FUNction:SUMMary:PHOLd](#).

To get a valid result, you have to perform a complete measurement with synchronization to the end of the measurement before reading out the result. This is only possible for single sweep mode.

See also [INITiate<n>:CONTInuous](#) on page 589.

**Suffix:**<n> [Window](#)<m> [Marker](#)**Return values:**

&lt;StandardDeviation&gt; Standard deviation of the signal during the measurement time.

**Usage:** Query only

---

**CALCulate<n>:MARKer<m>:FUNction:SUMMary:SDEViation:RESult?**

This command queries the standard deviation of the time domain power.

To get a valid result, you have to perform a complete measurement with synchronization to the end of the measurement before reading out the result. This is only possible for single sweep mode.

See also [INITiate<n>:CONTInuous](#) on page 589.

**Suffix:**<n> [Window](#)<m> [Marker](#)**Return values:**

&lt;StandardDeviation&gt; Standard deviation of the signal during the measurement time.

**Usage:** Query only

#### 9.6.9.4 Programming Example: Time Domain Power

This programming example demonstrates the measurement example described in [Chapter 8.2.9.6, "Measurement Example"](#), on page 365 in a remote environment.

```
//-----Configuring the Measurement-----
*RST
//Resets the instrument

INIT:CONT OFF
//Turns on single sweep mode.

FREQ:CENT 1.8GHz
//Sets the center frequency to 1.8 GHz.

BAND:RES 100kHz
//Sets the bandwidth to 100 kHz.

SWE:TIME 10ms
//Sets the sweep time to 640 μ s.

FREQ:SPAN 0
//Sets the instrument to zero span.

CALC:MARK:FUNC:SUMM:STAT ON
//Turns on time domain power measurements.

CALC:MARK:FUNC:SUMM:MEAN ON
CALC:MARK:FUNC:SUMM:PPE ON
CALC:MARK:FUNC:SUMM:RMS ON
//Turns the evaluation of the mean, peak and RMS time domain power.

CALC:MARK:X:SLIM ON
//Activates limit lines for evaluation.

CALC:MARK:X:SLIM:LEFT 1ms
//Sets the left limit line to 326 μ s.

CALC:MARK:X:SLIM:RIGH 6ms
//Sets the right limit line to 538 μ s.

//-----Performing the Measurement-----

INIT;*WAI
//Initiates the measurement and waits until the measurement is finished.

//-----Retrieving the Results-----
CALC:MARK:FUNC:SUMM:MEAN:RES?
CALC:MARK:FUNC:SUMM:PPE:RES?
CALC:MARK:FUNC:SUMM:RMS:RES?
//Queries the mean, peak and RMS time domain power.
```

## 9.6.10 Measuring the Harmonic Distortion

All remote control commands specific to harmonic distortion measurements are described here.

- [Activating the Measurement](#).....675
- [Configuring the Measurement](#).....675
- [Performing the Measurement](#).....677
- [Retrieving Results](#).....677
- [Example: Measuring the Harmonic Distortion](#).....678

### 9.6.10.1 Activating the Measurement

The following command activates harmonic distortion measurement.

`CALCulate<n>:MARKer<m>:FUNction:HARMonics[:STATe]`..... 675

---

**CALCulate<n>:MARKer<m>:FUNction:HARMonics[:STATe] <State>**

This command turns the harmonic distortion measurement on and off.

Note the following:

- If you perform the measurement in the frequency domain, the search range for the frequency of the first harmonic, whose power is determined, is defined by the last span.
- If you perform the measurement in the time domain, the current center frequency is used as the frequency of the first harmonic. Thus, the frequency search is bypassed. The first harmonic frequency is set by a specific center frequency in zero span before the harmonic measurement is started.

**Suffix:**

<n>                      [Window](#)

<m>                      [Marker](#)

**Parameters:**

<State>                ON | OFF | 1 | 0

\*RST:                0

**Example:**

`CALC:MARK:FUNC:HARM ON`

Activates the harmonic distortion measurement.

### 9.6.10.2 Configuring the Measurement

The following commands control the harmonic distortion measurement.

**Useful commands for harmonic distortion measurements described elsewhere**

- `CALCulate<n>:MARKer<m>:FUNction:CENTer` on page 712
- `[SENSe:]SWEep:TIME:AUTO` on page 728

**Remote commands exclusive to harmonic distortion measurements**

|                                                               |     |
|---------------------------------------------------------------|-----|
| CALCulate<n>:MARKer<m>:FUNction:HARMonics:BANDwidth:AUTO..... | 676 |
| CALCulate<n>:MARKer<m>:FUNction:HARMonics:NHARmonics.....     | 676 |
| CALCulate<n>:MARKer<m>:FUNction:HARMonics:PRESet.....         | 676 |

**CALCulate<n>:MARKer<m>:FUNction:HARMonics:BANDwidth:AUTO <State>**

This command selects the resolution bandwidth of the harmonic in respect to the bandwidth of the first harmonic.

**Suffix:**

<n>                      Window

<m>                      Marker

**Parameters:**

<State>                ON | OFF | 0 | 1

**OFF | 0**

identical

**ON | 1**

a multiple

\*RST:                1

**Manual operation:** See " [Harmonic RBW Auto](#) " on page 371

**CALCulate<n>:MARKer<m>:FUNction:HARMonics:NHARmonics <NoHarmonics>**

This command selects the number of harmonics that the R&S FPL1000 looks for.

**Suffix:**

<n>                      Window

<m>                      Marker

**Parameters:**

<NoHarmonics>      Range:            1 to 26

\*RST:                10

**Manual operation:** See " [Number of Harmonics](#) " on page 371

**CALCulate<n>:MARKer<m>:FUNction:HARMonics:PRESet**

This command initiates a measurement to determine the ideal configuration for the harmonic distortion measurement.

The method depends on the span.

- Frequency domain (span > 0)  
Frequency and level of the first harmonic are determined and used for the measurement list.
- Time domain (span = 0)  
The level of the first harmonic is determined. The frequency remains unchanged.

**Suffix:**

&lt;n&gt;                      Window

&lt;m&gt;                      Marker

**Manual operation:**    See " [Adjust Settings](#) " on page 371**9.6.10.3 Performing the Measurement**

The following commands are required to perform a harmonic distortion measurement:

[INITiate<n>\[:IMMEDIATE\]](#) on page 590, see [Chapter 9.6.1, "Performing Measurements"](#), on page 588

**9.6.10.4 Retrieving Results**

The following commands retrieve the results of the harmonic distortion measurement.

[CALCulate<n>:MARKer<m>:FUNCTION:HARMonics:DISTortion?](#)..... 677  
[CALCulate<n>:MARKer<m>:FUNCTION:HARMonics:LIST](#).....677

---

**CALCulate<n>:MARKer<m>:FUNCTION:HARMonics:DISTortion?**

This command queries the total harmonic distortion of the signal.

To get a valid result, you have to perform a complete measurement with synchronization to the end of the measurement before reading out the result. This is only possible for single sweep mode.

See also [INITiate<n>:CONTinuous](#) on page 589.

**Suffix:**

&lt;n&gt;                      Window

&lt;m&gt;                      Marker

**Query parameters:**

&lt;Result&gt;                TOTal

**Return values:**

&lt;DistortionPct&gt;

&lt;DistortionDb&gt;

**Usage:**                      Query only

---

**CALCulate<n>:MARKer<m>:FUNCTION:HARMonics:LIST**

This command queries the position of the harmonics.

To get a valid result, you have to perform a complete measurement with synchronization to the end of the measurement before reading out the result. This is only possible for single sweep mode.

See also [INITiate<n>:CONTinuous](#) on page 589.

**Suffix:**<n> [Window](#)<m> [Marker](#)**Return values:**

<Harmonics> Returns one value for every harmonic. The first value is the absolute power of the first harmonic. The unit is variable. The other values are power levels relative to the first harmonic. The unit for these is dB.

**9.6.10.5 Example: Measuring the Harmonic Distortion**

```
//-----Configuring the Measurement-----
*RST
//Resets the instrument.

INIT:CONT OFF
//Turns on single sweep mode.

CALC:MARK:FUNC:HARM ON
//Turns on the harmonic distortion measurement.
CALC:MARK:FUNC:HARM:NHAR 3
//Defines three harmonics to be found.

CALC:MARK:FUNC:HARM:BAND:AUTO OFF
//Turns off automatic bandwidth selection.
CALC:MARK:FUNC:HARM:PRES
//Determines the ideal configuration.

//-----Performing the Measurement-----

INIT;*WAI
//Initiates the measurement and finishes the sweep.

//-----Retrieving the Results-----
CALC:MARK:FUNC:HARM:LIST?
//Queries the position of the harmonics.
CALC:MARK:FUNC:HARM:DIST? TOT
//Queries the total harmonic distortion.
```

**9.6.11 Measuring the Third Order Intercept Point**

- [Determining the TOI](#).....679
- [Programming Example: Measuring the TOI](#).....680

### 9.6.11.1 Determining the TOI

All remote control commands specific to TOI measurements are described here.

#### Useful commands for TOI measurements described elsewhere

- [CALCulate<n>:DELTamarker<m>:X](#) on page 787
- [CALCulate<n>:DELTamarker<m>:X:RELative?](#) on page 802
- [CALCulate<n>:DELTamarker<m>:Y](#) on page 802
- [CALCulate<n>:MARKer<m>:X](#) on page 789
- [CALCulate<n>:MARKer<m>:Y](#) on page 803

#### Remote commands exclusive to TOI measurements

|                                                                                         |     |
|-----------------------------------------------------------------------------------------|-----|
| <a href="#">CALCulate&lt;n&gt;:MARKer&lt;m&gt;:FUNctioN:TOI[:STATe]</a> .....           | 679 |
| <a href="#">CALCulate&lt;n&gt;:MARKer&lt;m&gt;:FUNctioN:TOI:SEARChsignal ONCE</a> ..... | 679 |
| <a href="#">CALCulate&lt;n&gt;:MARKer&lt;m&gt;:FUNctioN:TOI:RESult?</a> .....           | 680 |

---

#### **CALCulate<n>:MARKer<m>:FUNctioN:TOI[:STATe]** <State>

This command initiates a measurement to determine the third intercept point.

A two-tone signal with equal carrier levels is expected at the RF input of the instrument. Marker 1 and marker 2 (both normal markers) are set to the maximum of the two signals. Delta marker 3 and delta marker 4 are positioned to the intermodulation products. The delta markers can be modified separately afterwards with the [CALCulate<n>:DELTamarker<m>:X](#) command.

The third-order intercept is calculated from the level spacing between the normal markers and the delta markers.

#### Suffix:

<n>                      [Window](#)

<m>                      [Marker](#)

#### Parameters:

<State>                ON | OFF | 1 | 0  
\*RST:                 0

#### Example:

`CALC:MARK:FUNC:TOI ON`  
Switches on the measurement of the third-order intercept.

---

#### **CALCulate<n>:MARKer<m>:FUNctioN:TOI:SEARChsignal ONCE**

This command initiates a search for signals in the current trace to determine the third intercept point.

#### Suffix:

<n>                      irrelevant

<m>                      irrelevant

**Manual operation:** See " [Search Signals](#) " on page 379

**CALCulate<n>:MARKer<m>:FUNCtion:TOI:RESult?**

This command queries the results for the third order intercept point measurement.

To get a valid result, you have to perform a complete measurement with synchronization to the end of the measurement before reading out the result. This is only possible for single sweep mode.

See also [INITiate<n>:CONTinuous](#) on page 589.

**Suffix:**

<n> [Window](#)

<m> [Marker](#)

**Return values:**

<TOI> Third order intercept point.

**Example:**

```
INIT:CONT OFF
Switches to single sweep mode.
CALC:MARK:FUNC:TOI ON
Switches the intercept measurement.
INIT;*WAI
Starts a sweep and waits for the end.
CALC:MARK:FUNC:TOI:RES?
Outputs the measured value.
```

**Usage:** Query only

**9.6.11.2 Programming Example: Measuring the TOI**

This example demonstrates how to determine the TOI in a remote environment.

```
//-----Configuring the measurement -----
*RST
//Reset the instrument
CALC:MARK:FUNC:TOI ON
//Activate TOI measurement.

//-----Performing the Measurement-----
INIT:CONT OFF
//Selects single sweep mode.

CALC:MARK:FUNC:TOI:SEAR ONCE
//Initiates a search for signals in the current trace.

//-----Retrieving Results-----
CALC:MARK:FUNC:TOI:RES?
//Returns the TOI.
```



## 9.6.12 Measuring the AM Modulation Depth

All remote control commands specific to AM modulation depth measurements are described here.

- [Configuring and Performing the Measurement](#)..... 681
- [Example: Measuring the AM Modulation Depth](#)..... 682

### 9.6.12.1 Configuring and Performing the Measurement

The following commands control the measurement.

#### Useful commands for AM modulation depth described elsewhere

- [CALCulate<n>:DELTaMarker<m>:X](#) on page 787
- [CALCulate<n>:DELTaMarker<m>:X:RELative?](#) on page 802
- [CALCulate<n>:MARKer<m>:X](#) on page 789

#### Remote commands exclusive to AM modulation depth measurements

|                                                                                            |     |
|--------------------------------------------------------------------------------------------|-----|
| <a href="#">CALCulate&lt;n&gt;:MARKer&lt;m&gt;:FUNcTION:MDEPth[:STATe]</a> .....           | 681 |
| <a href="#">CALCulate&lt;n&gt;:MARKer&lt;m&gt;:FUNcTION:MDEPth:SEARchsignal ONCE</a> ..... | 681 |
| <a href="#">CALCulate&lt;n&gt;:MARKer&lt;m&gt;:FUNcTION:MDEPth:RESult&lt;t&gt;?</a> .....  | 682 |

---

#### **CALCulate<n>:MARKer<m>:FUNcTION:MDEPth[:STATe]** <State>

This command turns the AM Modulation Depth measurement on and off.

To work correctly, the measurement requires an AM modulated signal.

##### Suffix:

<n>                      [Window](#)

<m>                      [Marker](#)

##### Parameters:

<State>                ON | OFF | 1 | 0  
 \*RST:                0

---

#### **CALCulate<n>:MARKer<m>:FUNcTION:MDEPth:SEARchsignal ONCE**

This command initiates a search for the signals required for the AM depth measurement.

Note that the command does not perform a new measurement, but looks for the signals on the current trace.

##### Suffix:

<n>                      [Window](#)

<m>                      [Marker](#)

**Example:** `CALC:MARK:FUNC:MDEP:SEAR ONCE`  
Executes the search of an AM modulated signal at the currently available trace.

**Manual operation:** See " [Search Signals](#) " on page 384

---

#### **CALCulate<n>:MARKer<m>:FUNction:MDEPth:RESult<t>?**

This command queries the results of the AM modulation depth measurement..

To get a valid result, you have to perform a complete measurement with synchronization to the end of the measurement before reading out the result. This is only possible for single sweep mode.

See also `INITiate<n>:CONTinuous` on page 589.

**Suffix:**

<n> [Window](#)

<m> [Marker](#)

<t> [Trace](#)

**Return values:**

<ModulationDepth> Modulation depth in %.

**Usage:** Query only

#### **9.6.12.2 Example: Measuring the AM Modulation Depth**

This example demonstrates how to determine the AM modulation depth in a remote environment. Note that without a real input signal this measurement will not return useful results.

```
//-----Configuring the measurement -----
*RST
//Reset the instrument
FREQ:CENT 100MHz
//Set center frequency
FREQ:SPAN 10KHz
// Set span
CALC:MARK:FUNC:MDEP ON
//Activate AM modulation depth measurement.

//-----Performing the Measurement-----
INIT:CONT OFF
//Selects single sweep mode.
INIT:IMM
// Perform a single measurement
CALC:MARK:FUNC:MDEP:SEAR ONCE
//Initiates a search for signals in the current trace.

//-----Retrieving Results-----
CALC:MARK:FUNC:MDEP:RES?
```

```
//Queries the measurement results.

//If the results are not accurate, change the position of the
//the temporary markers manually.

//----Changing the position of the temp markers----
CALC:MARK:X 100MHZ
//Positions the reference marker on 100 MHz.
CALC:DELT2:X 5KHZ
//Positions delta marker 2 and 3 at a distance of 5 kHz to the reference marker.
CALC:DELT3:X 1KHZ
//Corrects the position of delta marker 3 by 1 kHz.

CALC:MARK:FUNC:MDEP:RES?
//Queries the measurement results for the repositioned markers.
```

### 9.6.13 Remote Commands for EMI Measurements

The following commands are required to perform EMI measurements in a remote environment. This measurement requires the R&S FPL1-K54 option.

The following tasks specific to the EMI application are described here:

- [Activating EMI Measurement](#)..... 683
- [Configuring EMI Markers](#)..... 684
- [Configuring the EMI Final Test](#)..... 685
- [Configuring EMI Limit Lines](#)..... 686
- [Controlling LISN](#)..... 686
- [Retrieving EMI Results](#)..... 687
- [Evaluating the Results](#)..... 689
- [Programming Example: EMI Measurement](#)..... 689

#### 9.6.13.1 Activating EMI Measurement

EMI measurement must be activated explicitly.

```
CALCulate<n>:DELTaMarker<m>:FUNctIon:FMEaSurement[:STATe]..... 683
CALCulate<n>:MARKer<m>:FUNctIon:FMEaSurement[:STATe]..... 683
```

---

```
CALCulate<n>:DELTaMarker<m>:FUNctIon:FMEaSurement[:STATe] <State>
CALCulate<n>:MARKer<m>:FUNctIon:FMEaSurement[:STATe] <State>
```

This command turns the EMI measurement marker functionality on and off.

**Suffix:**

<n>                    irrelevant

<m>                    irrelevant

**Parameters:**

<State>                ON | OFF | 1 | 0

### 9.6.13.2 Configuring EMI Markers

The commands required to configure EMI markers are described here.

Useful commands for configuring EMI markers described elsewhere:

- [CALCulate<n>:MARKer<m>\[:STATe\]](#) on page 789  
[CALCulate<n>:DELTamarker<m>\[:STATe\]](#) on page 787
- [CALCulate<n>:MARKer<m>\[:STATe\]](#) on page 789  
[CALCulate<n>:DELTamarker<m>\[:STATe\]](#) on page 787
- [CALCulate<n>:DELTamarker<m>:MREference](#) on page 786
- [CALCulate<n>:MARKer<ms>:LINK:TO:MARKer<md>](#) on page 788  
[CALCulate<n>:DELTamarker<ms>:LINK:TO:MARKer<md>](#) on page 785  
[CALCulate<n>:DELTamarker<m>:LINK](#) on page 785
- [CALCulate<n>:MARKer<m>:TRACe](#) on page 789

#### Remote commands exclusive to configuring EMI markers

|                                                                                              |     |
|----------------------------------------------------------------------------------------------|-----|
| <a href="#">CALCulate&lt;n&gt;:DELTamarker&lt;m&gt;:FUNCTION:FMEasurement:DETECTOR</a> ..... | 684 |
| <a href="#">CALCulate&lt;n&gt;:MARKer&lt;m&gt;:FUNCTION:FMEasurement:DETECTOR</a> .....      | 684 |

---

**CALCulate<n>:DELTamarker<m>:FUNCTION:FMEasurement:DETECTOR** <Detector>  
**CALCulate<n>:MARKer<m>:FUNCTION:FMEasurement:DETECTOR** <Detector>

This command selects the detector for a specific marker during the final measurement.

If the marker is not yet active, the command also turns the marker on.

#### Suffix:

<n>                      [Window](#)

<m>                      [Marker](#)

#### Parameters:

<Detector>            **OFF**  
no final measurement is performed

**AVER**  
average detector

**CAV**  
CISPR Average detector

**CRMS**  
RMS Average detector

**POS**  
maximum peak detector

**QPE**  
quasipeak detector

\*RST:                OFF

**Manual operation:** See "[Final Test Detector](#)" on page 398

### 9.6.13.3 Configuring the EMI Final Test

The commands required to configure the EMI final test are described here.

Useful commands for configuring EMI final tests described elsewhere:

- [SENSe:]BANDwidth[:RESolution]:TYPE on page 723
- [SENSe:]BANDwidth[:RESolution] on page 722
- DISPlay[:WINDow<n>][:SUBWindow<w>]:TRACe<t>:X:SPACing on page 713

#### Remote commands exclusive to configuring EMI final tests

|                                                                        |     |
|------------------------------------------------------------------------|-----|
| CALCulate<n>:MARKer<m>:FUNCTION:FMEasurement:PEAKsearch:AUTO.....      | 685 |
| CALCulate<n>:DELTamarker<m>:FUNCTION:FMEasurement:PSEarch:AUTO.....    | 685 |
| CALCulate<n>:MARKer<m>:FUNCTION:FMEasurement:PSEarch:AUTO.....         | 685 |
| CALCulate<n>:DELTamarker<m>:FUNCTION:FMEasurement:PEAKsearch:AUTO..... | 685 |
| CALCulate<n>:DELTamarker<m>:FUNCTION:FMEasurement:DWELI.....           | 685 |
| CALCulate<n>:MARKer<m>:FUNCTION:FMEasurement:DWELI.....                | 685 |

---

**CALCulate<n>:MARKer<m>:FUNCTION:FMEasurement:PEAKsearch:AUTO**  
<State>

**CALCulate<n>:DELTamarker<m>:FUNCTION:FMEasurement:PSEarch:AUTO**  
<Mode>

**CALCulate<n>:MARKer<m>:FUNCTION:FMEasurement:PSEarch:AUTO** <State>

**CALCulate<n>:DELTamarker<m>:FUNCTION:FMEasurement:PEAKsearch:AUTO**  
<Mode>

**Suffix:**

<n> 1..n

<m> 1..n

**Parameters:**

<Mode>

---

**CALCulate<n>:DELTamarker<m>:FUNCTION:FMEasurement:DWELI** <Time>

**CALCulate<n>:MARKer<m>:FUNCTION:FMEasurement:DWELI** <Time>

This command defines the dwell time during the final measurement.

**Suffix:**

<n> irrelevant

<m> irrelevant

**Parameters:**

<Time> Range: 100 us to 100 s

\*RST: 1 s

Default unit: s

**Manual operation:** See " Dwell Time " on page 401

### 9.6.13.4 Configuring EMI Limit Lines

The commands required to define limit lines for EMI measurements are described in [Chapter 9.8.9, "Configuring Display and Limit Lines"](#), on page 843.

### 9.6.13.5 Controlling LISN

The commands required to control a LISN are described here.

This feature requires the optional additional interfaces (R&S FPL1-B5).

|                                                                 |     |
|-----------------------------------------------------------------|-----|
| <a href="#">INPut&lt;ip&gt;:LISN:FILTer:HPASs[:STATe]</a> ..... | 686 |
| <a href="#">INPut&lt;ip&gt;:LISN:PHASe</a> .....                | 686 |
| <a href="#">INPut&lt;ip&gt;:LISN[:TYPE]</a> .....               | 687 |

---

#### **INPut<ip>:LISN:FILTer:HPASs[:STATe] <State>**

This command turns the 150 kHz highpass filter for the ENV216 network on and off.

##### **Suffix:**

<ip>                    1 | 2  
                          irrelevant

##### **Parameters:**

<State>                ON | OFF | 0 | 1  
                          **OFF | 0**  
                          Switches the function off  
                          **ON | 1**  
                          Switches the function on  
                          \*RST:        0

##### **Example:**

```
//Turn on high pass filter
INP:LISN:TYPE ENV216
INP:LISN:FILT:HPAS ON
```

**Manual operation:** See " [150 kHz Highpass](#) " on page 403

---

#### **INPut<ip>:LISN:PHASe <Phase>**

This command selects one LISN phase to be measured.

##### **Suffix:**

<ip>                    1 | 2  
                          irrelevant

##### **Parameters:**

<Phase>                **L1**  
                          **L2**  
                          Available for networks with four phases (R&S ESH2Z5,  
                          R&S ENV4200 and R&S ENV432)

**L3**

Available for networks with four phases (R&S ESH2Z5, R&S ENV4200 and R&S ENV432)

**N**

\*RST: L1

**Example:** //Select phase L1  
INP:LISN:PHAS L1

**Manual operation:** See " [Phase](#) " on page 403

**INPut<ip>:LISN[:TYPE] <Type>**

This command turns automatic control of a LISN on and off. It also selects the type of network.

**Suffix:**

<ip> 1 | 2  
irrelevant

**Parameters:**

<Type> **ENV216**  
R&S ENV 216: two phases and highpass are controllable.

**ENV4200**  
R&S ENV 4200: four phases are controllable.

**ESH2Z5**  
R&S ESH2-Z5: four phases (incl. protective earth) are controllable.

**ESH3Z5**  
R&S ESH3-Z5: two phases (incl. protective earth) are controllable.

**FOURphase**  
R&S ESH2-Z5: four phases (incl. protective earth) are controllable.

**OFF**  
Turns off remote control of the LISN.

**TWOPhase**  
R&S ESH3-Z5: two phases (incl. protective earth) are controllable.

\*RST: OFF

**Example:** //Select LISN  
INP:LISN:TYPE TWOP

**Manual operation:** See " [LISN Type](#) " on page 403

**9.6.13.6 Retrieving EMI Results**

The commands required to retrieve EMI measurement results are described here.

Useful commands for retrieving EMI measurement results described elsewhere:

- `CALCulate<n>:MARKer<m>:X` on page 789  
`CALCulate<n>:DELTamarker<m>:X` on page 787
- `CALCulate<n>:MARKer<m>:Y` on page 803  
`CALCulate<n>:DELTamarker<m>:Y` on page 802

#### Remote commands exclusive to retrieving EMI measurement results

|                                                                                                              |     |
|--------------------------------------------------------------------------------------------------------------|-----|
| <code>CALCulate&lt;n&gt;:DELTamarker&lt;m&gt;:FUNCTION:FMEasurement:RESult?</code> .....                     | 688 |
| <code>CALCulate&lt;n&gt;:MARKer&lt;m&gt;:FUNCTION:FMEasurement:RESult?</code> .....                          | 688 |
| <code>CALCulate&lt;n&gt;:DELTamarker&lt;m&gt;:FUNCTION:FMEasurement:LIMit&lt;li&gt;:LCONdition?</code> ..... | 688 |
| <code>CALCulate&lt;n&gt;:MARKer&lt;m&gt;:FUNCTION:FMEasurement:LIMit&lt;li&gt;:LCONdition?</code> .....      | 688 |
| <code>CALCulate&lt;n&gt;:DELTamarker&lt;m&gt;:FUNCTION:FMEasurement:LIMit&lt;li&gt;:LDELta?</code> .....     | 689 |
| <code>CALCulate&lt;n&gt;:MARKer&lt;m&gt;:FUNCTION:FMEasurement:LIMit&lt;li&gt;:LDELta?</code> .....          | 689 |

---

**`CALCulate<n>:DELTamarker<m>:FUNCTION:FMEasurement:RESult? <Result>`**

**`CALCulate<n>:MARKer<m>:FUNCTION:FMEasurement:RESult? <Result>`**

This command queries the result of the EMI measurement at the marker position.

#### Suffix:

`<n>`                      Window

`<m>`                      Marker

#### Return values:

`<Result>`                      Power level. The unit depends on the one you have currently set.

**Example:**                      `CALC:MARK1:FUNC:FME:RES?`  
Queries the result of marker 1.

**Usage:**                      Query only

---

**`CALCulate<n>:DELTamarker<m>:FUNCTION:FMEasurement:LIMit<li>:LCONdition? <Condition>`**

**`CALCulate<n>:MARKer<m>:FUNCTION:FMEasurement:LIMit<li>:LCONdition? <Condition>`**

This command queries the condition of a marker position in relation to a certain limit line.

#### Suffix:

`<n>`                      Window

`<m>`                      Marker

`<li>`                      Limit line

#### Return values:

`<Condition>`                      **0**  
The marker has passed the limit check.

**1**  
The marker is inside the margins of a limit line.



**2**

The marker has failed the limit check.

**Example:** `CALC:MARK1:FUNC:FME:LIM2:LCON?`  
Queries the condition of marker 1 in relation to limit line 2.

**Usage:** Query only

**CALCulate<n>:DELTa<m>:FUNCTion:FMEasurement:LIMit<li>:LDELta?**  
**CALCulate<n>:MARKer<m>:FUNCTion:FMEasurement:LIMit<li>:LDELta?**  
<Amplitude>

This command queries the vertical distance from the marker position to the limit line. The unit is dB.

If the marker has been assigned to a different trace than the limit line, or if no limit line is defined for the marker position, the command returns -200.

**Suffix:**

<n> [Window](#)  
<m> [Marker](#)  
<li> 1..n  
[Limit line](#)

**Return values:**

<Amplitude> Vertical distance to the limit line in dB.

**Example:** `CALC:MARK3:FUNC:FME:LIM2:LDEL?`  
Queries the distance of marker 3 to the second limit line.

**Usage:** Query only

**9.6.13.7 Evaluating the Results**

The commands required to control the demodulation of signals at the marker position are described in [Chapter 9.8.8.14, "Marker Demodulation"](#), on page 831.

**9.6.13.8 Programming Example: EMI Measurement**

This example demonstrates how to detect electromagnetic interferences (EMI) in a remote environment.

```
//----- Preparing the measurement -----
//Reset the instrument
*RST
//Define the span to be analyzed
FREQ:STAR 150kHz
FREQ:STOP 1GHz
//Configure two traces, one with peak detector, one with average detector
DISP:TRAC1 ON
DISP:TRAC2 ON
DET1 POS
```

```

DET2 AVER

//----- Configuring the measurement -----
//Select EMI measurement
CALC:MARK:FUNC:FME:STAT ON
//Configure CISPR filter and RBW
BAND:TYPE CISP
BAND:RES 1MHz
//Define the dwell time
CALC:MARK:FUNC:FME:DWEL 1ms
//Configure an auto peak search
CALC:MARK:FUNC:FME:PEAK:AUTO ON
//Configure a logarithmic frequency scaling
DISP:TRAC:X:SPAC LOG
//Configure marker demodulation for marker 1
CALC:MARK:FUNC:DEM ON
//Increase the number of sweep points
SWE:POIN 200000
//Set the unit to V
CALC:UNIT:POW V

//----- Configuring EMI markers -----
//Activate 6 normal EMI markers
CALC:MARK1 ON
CALC:MARK2 ON
CALC:MARK3 ON
CALC:MARK4 ON
CALC:MARK5 ON
CALC:MARK6 ON
//Set markers 1 to 3 on trace 1. Set markers 4 to 6 on trace 2.
CALC:MARK1:TRAC 1
CALC:MARK2:TRAC 1
CALC:MARK3:TRAC 1
CALC:MARK4:TRAC 2
CALC:MARK5:TRAC 2
CALC:MARK6:TRAC 2
//Use CISPR average detector for all markers during final test
CALC:MARK1:FUNC:FME:DET CAV
CALC:MARK2:FUNC:FME:DET CAV
CALC:MARK3:FUNC:FME:DET CAV
CALC:MARK4:FUNC:FME:DET CAV
CALC:MARK5:FUNC:FME:DET CAV
CALC:MARK6:FUNC:FME:DET CAV

//----- Configuring a limit check -----
//Select EN55011A.LIN as limit line 1
CALC:LIM1:NAME "EN55011A.LIN"
//Configure trace 1 to be checked against limit line 1
CALC:LIM1:TRAC1:CHEC ON

```

```

//Clear the results of all previous limit checks
CALC:LIM:CLE

//----- Performing the Measurement -----
//Select single sweep mode.
INIT:CONT OFF
//Initiate a new measurement and wait until the sweep has finished.
INIT;*WAI

//----- Retrieving Results -----
//Query the results for the EMI measurement
//First marker frequency, then final test level
CALC:MARK1:X?
CALC:MARK1:FUNC:FME:RES?
CALC:MARK2:X?
CALC:MARK2:FUNC:FME:RES?
CALC:MARK3:X?
CALC:MARK3:FUNC:FME:RES?
CALC:MARK4:X?
CALC:MARK4:FUNC:FME:RES?
CALC:MARK5:X?
CALC:MARK5:FUNC:FME:RES?
CALC:MARK6:X?
CALC:MARK6:FUNC:FME:RES?

//Query the result of the limit check for trace 1
CALC:LIM1:FAIL?
//Query the result of the limit check and the distance from the limit lines
//for each marker
CALC:MARK1:FUNC:FME:LIM:COND?
CALC:MARK1:FUNC:FME:LIM:DELT?
CALC:MARK2:FUNC:FME:LIM:COND?
CALC:MARK2:FUNC:FME:LIM:DELT?
CALC:MARK3:FUNC:FME:LIM:COND?
CALC:MARK3:FUNC:FME:LIM:DELT?
CALC:MARK4:FUNC:FME:LIM:COND?
CALC:MARK4:FUNC:FME:LIM:DELT?
CALC:MARK5:FUNC:FME:LIM:COND?
CALC:MARK5:FUNC:FME:LIM:DELT?
CALC:MARK6:FUNC:FME:LIM:COND?
CALC:MARK6:FUNC:FME:LIM:DELT?

```

### 9.6.14 List Evaluations

A list evaluation is a multiple power measurement that measures the power at up to 200 frequencies. The measurement itself is a time domain measurement. Note that if you set a span greater than 0, the R&S FPL1000 aborts the list evaluation.

In case of a triggered measurement, a separate trigger event is required for each frequency to initiate that measurement. Note that you have to make changes to the trigger level in the time domain in order for it to take effect for the List Evaluation commands.



The list evaluation is incompatible to other measurement functions (e.g. marker functionality or statistics). If you use a command that controls those functions, the R&S FPL1000 aborts the list evaluation.

The R&S FPL1000 also aborts the list evaluation if you end the remote session.

The commands can be used in two different ways.

- Instrument setup, measurement and querying of the results in a single command line. This method causes the least delay between the measurement and the result output. However, it requires the control computer to wait for the response from the instrument.
- Instrument setup and querying of the result list at the end of the measurement: With this method, the control computer may be used for other activities while the measurement is being performed. However, more time is needed for synchronization via service request.

#### 9.6.14.1 Performing List Evaluations

All remote control commands specific to list evaluations (which are available via remote control only) are described here.

##### Remote commands exclusive to list evaluation

|                               |     |
|-------------------------------|-----|
| [SENSe:]LIST:POWer:RESult?    | 692 |
| [SENSe:]LIST:POWer[:SEQuence] | 693 |
| [SENSe:]LIST:POWer:SET        | 694 |
| [SENSe:]LIST:POWer:STATe      | 694 |

##### [SENSe:]LIST:POWer:RESult?

This command queries the results of the list evaluation.

This command may be used to obtain measurement results in an asynchronous way, using the service request mechanism for synchronization to the end of the measurement.

If there are no results, the command returns an error.

##### Return values:

<PowerLevel>      Power level for each frequency included in the measurement. The command returns up to 3 power levels for each frequency, depending on the number of evaluation modes you have turned on with [SENSe:]LIST:POWer:SET. The result is a list of floating point values separated by commas. The unit depends on CALCulate<n>:UNIT:POWer.

**Usage:** Query only

---

### [SENSe:]LIST:POWer[:SEQuence]

This command configures and initiates the List Evaluation measurement.

The list can contain up to 200 entries (frequencies). You can define a different instrument setup for each frequency that is in the list.

If you synchronize the measurement with \*OPC, the R&S FPL1000 produces a service request when all frequencies have been measured and the number of individual measurements has been performed.

Note that using the command as a query initiates the measurement and returns the results if all frequencies have been measured. For more information on querying the results see [\[SENSe:\]LIST:POWer:RESult?](#).

#### Parameters:

|                 |                                                                                                                                                                                                                                                                                                                                                                              |
|-----------------|------------------------------------------------------------------------------------------------------------------------------------------------------------------------------------------------------------------------------------------------------------------------------------------------------------------------------------------------------------------------------|
| <Frequency>     | Defines the frequency. Each frequency corresponds to one list entry.<br>Range: 0 to Fmax<br>Default unit: Hz                                                                                                                                                                                                                                                                 |
| <RefLevel>      | Defines the reference level for a list entry.<br>Range: -130 to 30<br>Increment: 0.01<br>Default unit: dBm                                                                                                                                                                                                                                                                   |
| <RFAttenuation> | Defines the RF attenuation for a list entry.<br>Range: 0 to 70<br>Increment: 1<br>Default unit: dB                                                                                                                                                                                                                                                                           |
| <FilterType>    | Selects the filter type for a list entry. For more information see <a href="#">[SENSe:]BANDwidth[:RESolution]:TYPE</a> .                                                                                                                                                                                                                                                     |
| <RBW>           | Defines the resolution bandwidth for a list entry.                                                                                                                                                                                                                                                                                                                           |
| <VBW>           | Defines the measurement time for a list entry.                                                                                                                                                                                                                                                                                                                               |
| <MeasTime>      | Defines the measurement time for a list entry.<br>Range: 1 $\mu$ s to 16000 s<br>Default unit: s                                                                                                                                                                                                                                                                             |
| <TriggerLevel>  | The trigger level must be 0.                                                                                                                                                                                                                                                                                                                                                 |
| <PowerLevel>    | Power level for each frequency included in the measurement. The command returns up to 3 power levels for each frequency, depending on the number of evaluation modes you have turned on with <a href="#">[SENSe:]LIST:POWer:SET</a> . The result is a list of floating point values separated by commas. The unit depends on <a href="#">CALCulate&lt;n&gt;:UNIT:POWer</a> . |

---

**[SENSe:]LIST:POWer:SET** <PeakPower>, <RMSPower>, <AVGPower>, <TriggerSource>, <TriggerSlope>, <TriggerOffset>, <GateLength>

This command defines global List Evaluation parameters.

These parameters are valid for every frequency you want to measure.

The state of the first three parameters (<PeakPower>, <RMSPower> and <AVGPower>) define the number of results for each frequency in the list.

Note that you have to set the trigger level *after* sending this command.

**Parameters:**

|                 |                                                                                                                                                                                                                                                      |
|-----------------|------------------------------------------------------------------------------------------------------------------------------------------------------------------------------------------------------------------------------------------------------|
| <PeakPower>     | ON   OFF   0   1<br>Turns peak power evaluation on and off.<br>*RST: 1                                                                                                                                                                               |
| <RMSPower>      | ON   OFF   0   1<br>Turns RMS power evaluation on and off.<br>*RST: 0                                                                                                                                                                                |
| <AVGPower>      | ON   OFF   0   1<br>Turns average power evaluation on and off.<br>*RST: 0                                                                                                                                                                            |
| <TriggerSource> | IMMediate   LINE   EXTernal   VIDEo   RFPower   IFPower   RFPower   EXT2   EXT3   EXT4   LXI<br>Selects a trigger source.                                                                                                                            |
| <TriggerSlope>  | POSitive   NEGative<br>Selects the trigger slop.                                                                                                                                                                                                     |
| <TriggerOffset> | Defines the trigger delay.<br>Range: negative measurement time to 30 s<br>*RST: 0<br>Default unit: s                                                                                                                                                 |
| <GateLength>    | Defines the gate length for gated measurements.<br>Setting 0 seconds turns gated measurements off.<br>To perform gated measurements, the trigger source must be different from IMMediate.<br>Range: 31.25 ns to 30 s<br>*RST: 0 s<br>Default unit: s |

---

**[SENSe:]LIST:POWer:STATe** <State>

This command turns the List Evaluation off.

**Parameters:**

|         |                    |
|---------|--------------------|
| <State> | OFF   0<br>*RST: 0 |
|---------|--------------------|

### 9.6.14.2 Example: Performing List Evaluation

The following example shows a list evaluation with the following configuration.

| No | Freq [MHz] | Ref Level [dBm] | RF Attenuation [dB] | EI Attenuation [dB] | Filter  | RBW    | VBW     | Meas Time   | Trigger Level |
|----|------------|-----------------|---------------------|---------------------|---------|--------|---------|-------------|---------------|
| 1  | 935.2      | 0               | 10                  | ---                 | Normal  | 1 MHz  | 3 MHz   | 440 $\mu$ s | 0             |
| 2  | 935.4      | 0               | 10                  | 10                  | Channel | 30 kHz | 100 kHz | 440 $\mu$ s | 0             |
| 3  | 935.6      | 0               | 10                  | 20                  | Channel | 30 kHz | 100 kHz | 440 $\mu$ s | 0             |

```

-----Measurement with synchronization via service request-----
*ESE 1
*SRE 32
// Configures the status reporting system to produce a service request.
LIST:POW:SET ON,ON,OFF,EXT,POS,10us,434us
//Turns on the list evaluation, configures the global list evaluation settings and
//evaluates the peak and RMS power.
LIST:POW
935.2MHZ,0,10,OFF,NORM,1MHZ,3MHZ,440us,0,
935.4MHZ,0,10,10,CFIL,30KHZ,100KHZ,440us,0,
935.6MHZ,0,10,20,CFIL,30KHZ,100KHZ,440us,0;
*OPC
//Defines a list with 3 entries and initiates the measurement with synchronization to the end
//Analyzer produces a service request
//On service request:
SENS:LIST:POW:RES?
//Returns the results of the measurements, two for each frequency (peak and RMS power).

-----Initiliazing the measurement and querying results simultaneously-----
LIST:POW?
935.2MHZ,0,10,OFF,NORM,1MHZ,3MHZ,440us,0,
935.4MHZ,0,10,10,CFIL,30KHZ,100KHZ,440us,0,
935.6MHZ,0,10,20,CFIL,30KHZ,100KHZ,440us,0
//Defines a list with 3 entries, initiates the measurement and queries the results.
//Result example:
-28.3,-30.6,-38.1

```

### 9.6.15 Measuring the Pulse Power

All remote control commands specific to measuring the mean or peak pulse power (e.g. bursts in various telecommunications standards) are described here. This measurement is available via remote control only.

The Pulse Power measurement is a gated measurement that determines the power over a particular number of pulses. The measurement is controlled by an external trig-

ger or the video signal. A separate trigger event is required for each burst included in the measurement. In case of an external trigger source, the trigger level corresponds to the TTL level. In case of a video signal, you can define any threshold.

The figure below shows the relations between the available trigger settings.

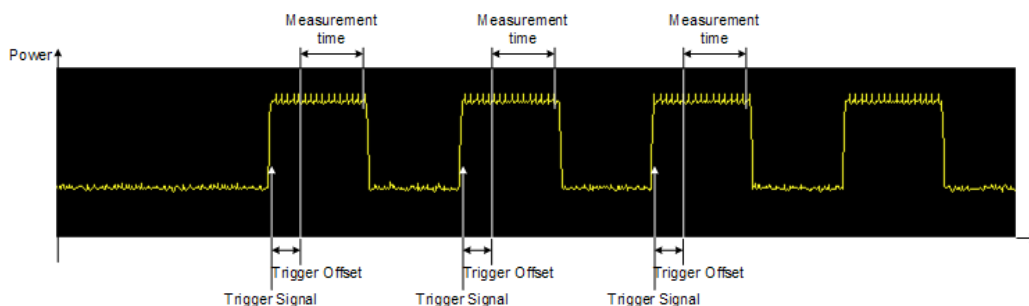

The measurement is always on trace 1, either with the peak detector to determine the peak power or the RMS detector to determine the RMS power. Overall, you can configure the measurement independent of the instrument setup with the commands listed below only, which results in faster measurements.



The Pulse Power measurement is incompatible to other measurement functions (e.g. marker functionality or statistics). If you use a command that controls those functions, the R&S FPL1000 aborts the Pulse Power measurement.

The R&S FPL1000 also aborts the Pulse Power measurement if you end the remote session.

The commands can be used in two different ways.

- Instrument setup, measurement and querying of the results in a single command line. With this method, there is the least delay between the measurement and the result output. However, it requires the control computer to wait for the response from the instrument.
- Instrument setup and querying of the result list at the end of the measurement: With this method, the control computer may be used for other activities while the measurement is being performed. However, more time is needed for synchronization via service request.

### 9.6.15.1 Performing Pulse Power Measurements

The following commands control pulse power measurements.

|                                                                            |     |
|----------------------------------------------------------------------------|-----|
| <a href="#">CALCulate&lt;n&gt;:MARKer&lt;m&gt;:FUNCtion:MSUMmary</a> ..... | 697 |
| <a href="#">[SENSe:]MPOWER:FTYPE</a> .....                                 | 697 |
| <a href="#">[SENSe:]MPOWER:RESult[:LIST]?</a> .....                        | 698 |
| <a href="#">[SENSe:]MPOWER[:SEQUence]</a> .....                            | 698 |
| <a href="#">[SENSe:]MPOWER:RESult:MIN?</a> .....                           | 699 |



**CALCulate**<n>:**MARKer**<m>:**FUNCTION:MSUMmary** <TimeOffset>, <MeasTime>, <PulsePeriod>, <OfPulses>

This command configures power measurements on pulses in the time domain.

To evaluate the pulse power, the R&S FPL1000 uses the data captured during a previous measurement. The data recorded during the set measurement time is combined to a measured value for each pulse according to the detector specified and the indicated number of results is output as a list.

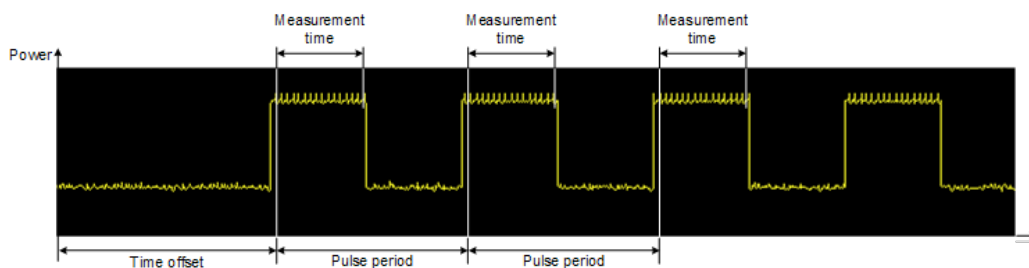

To get a valid result, you have to perform a complete measurement with synchronization to the end of the measurement before reading out the result. This is only possible for single sweep mode.

See also [INITiate](#)<n>:[CONTinuous](#) on page 589.

**Suffix:**

<n> [Window](#)

<m> [Marker](#)

**Parameters:**

<TimeOffset> Defines a time offset to start the measurement at the first pulse of a trace.

\*RST: 0

Default unit: s

<MeasTime> Defines the measurement time.

Default unit: s

<PulsePeriod> Defines the pulse period.

Default unit: s

<OfPulses> Defines the number of pulses to measure.

**Example:**

`CALC:MARK:FUNC:MSUM 50US,450US,576.9US,8`

Evaluates data that contains 8 pulses during a measurement time of 450  $\mu$ s and a pulse period of 576.9  $\mu$ s. The evaluation starts with an offset of 50  $\mu$ s.

**[SENSe:]MPOWER:FTYPE** <FilterType>

This command selects the filter type for pulse power measurements.

**Parameters:**

<FilterType> **CFILter**

**NORMAL****[SENSe:]MPOWer:RESult[:LIST]?**

This command queries the results of the pulse power measurement.

This command may be used to obtain measurement results in an asynchronous way, using the service request mechanism for synchronization to the end of the measurement.

If there are no results, the command returns an error.

**Return values:**

<PulsePower> List of pulse powers.  
The number of values depends on the number of pulses you have been measuring.  
The unit is dBm.

**Usage:** Query only

---

**[SENSe:]MPOWer[:SEQUence]** <Frequency>, <RBW>, <MeasTime>, <TriggerSource>, <TriggerLevel>, <TriggerOffset>, <Detector>, <NoPulses>

This command configures and initiates the pulse power measurement.

The R&S FPL1000 caches all measurement parameters that you can set with this command. If you use the command repeatedly, the R&S FPL1000 only changes those settings that you have actually changed before initiating the measurement. Thus, measurement times are kept as low as possible.

If you synchronize the measurement with \*OPC, the R&S FPL1000 produces a service request when all frequencies have been measured and the number of individual measurements has been performed.

Note that using the command as a query initiates the measurement and returns the results if all frequencies have been measured. For more information on querying the results see [\[SENSe:\]LIST:POWer:RESult?](#).

**Parameters:**

<Frequency> Defines the pulse frequency.  
Range: 0 to Fmax  
Default unit: Hz

<RBW> Defines the resolution bandwidth.  
Default unit: HZ

<MeasTime> Defines the measurement time.  
Range: 1  $\mu$ s to 30 s  
Default unit: S

<TriggerSource> Selects a trigger source.

|                       |                                                                                                                                                                                                                                                                                     |
|-----------------------|-------------------------------------------------------------------------------------------------------------------------------------------------------------------------------------------------------------------------------------------------------------------------------------|
| <TriggerLevel>        | <p>Defines a trigger level.<br/>The trigger level is available for the video trigger. In that case, the level is a percentage of the diagram height.<br/>In case of an external trigger, the R&amp;S FPL1000 uses a fix TTL level.</p> <p>Range: 0 to 100<br/>Default unit: PCT</p> |
| <TriggerOffset>       | <p>Defines the trigger delay.</p> <p>Range: 0 s to 30 s<br/>*RST: 0 s<br/>Default unit: s</p>                                                                                                                                                                                       |
| <Detector>            | <p>Selects the detector and therefore the way the measurement is evaluated.</p> <p><b>MEAN</b><br/>Calculates the RMS pulse power.</p> <p><b>PEAK</b><br/>Calculates the peak pulse power.</p>                                                                                      |
| <OfPulses>            | <p>Defines the number of pulses included in the measurement.</p> <p>Range: 1 to 32001</p>                                                                                                                                                                                           |
| <b>Return values:</b> |                                                                                                                                                                                                                                                                                     |
| <PowerLevel>          | <p>Pulse power level.<br/>The result is a list of floating point values separated by commas.<br/>The unit is dBm.</p>                                                                                                                                                               |

---

#### [SENSe:]MPOWer:RESult:MIN?

This command queries the lowest pulse power that has been measured during a pulse power measurement.

If there are no results, the command returns an error.

#### Return values:

|              |                                                                        |
|--------------|------------------------------------------------------------------------|
| <PulsePower> | Lowest power level of the pulse power measurement.<br>The unit is dBm. |
|--------------|------------------------------------------------------------------------|

**Usage:** Query only

### 9.6.15.2 Example: Performing a Pulse Power Measurement

The following example shows a pulse power measurement.

```

-----Measurement with synchronization via service request-----
*ESE 1
*SRE 32
// Configures the status reporting system to produce a service request.
MPOW:FTYP NORM
//Selects a Gaussian filter for the measurement.
MPOW 935.2MHZ,1MHZ,434us,VID,50,5us,MEAN,20;

```

```

*OPC
//Configures and initiates a measurement on 20 pulses with synchronization to the end.
//Analyzer produces a service request
//On service request:
MPOW:RES?
//Returns the results of the measurements (20 power levels).
MPOW:RES:MIN?
//Returns the lowest of the 20 power level that have been measured.

-----Initiliazing the measurement and querying results simultaneously-----
MPOW? 935.2MHZ,1MHZ,434us,VID,50,5us,MEAN,20
//Configures, initiates and queries the results of the measurement.
//Result example:
-105.225059509,-105.656074524,-105.423065186,-104.374649048,-103.059822083,-101.29511261,
-99.96534729,-99.7452468872,-99.6610794067,-100.327224731,-100.96686554,-101.450386047,
-102.150642395,-103.240142822,-105.95476532,-110.583129883,-115.7760849,-126.279388428,
-124.620399475,-116.97366333

```

### 9.6.16 Programming Example: Performing a Basic Frequency Sweep

This example demonstrates how to configure and perform a basic frequency sweep measurement in a remote environment.

This example assumes a signal is measured at 100 MHz, with a maximum power level of -3 dBm.



Some commands in the following examples may not be necessary as they reflect the default settings; however, they are included to demonstrate the command usage.

```

//-----Preparing the measurement -----
*RST
//Resets the instrument
INIT:CONT OFF
//Selects single sweep mode.

//-----Configuring the Frequency and Span-----
FREQ:CENT 100MHz
//Defines the center frequency
FREQ:SPAN 100MHz
//Sets the span to 50 MHz on either side of the center frequency.

//-----Configuring the Bandwidth-----
BAND:AUTO OFF
BAND 1MHz
//Defines the RBW as 1 MHz

BAND:VID 500kHz
//Decouples the VBW from the RBW and decreases it to smooth the trace.

```

```

//-----Configuring the Sweep-----
SENS:SWE:COUN 10
//Defines 10 sweeps to be performed in each measurement.
SENS:SWE:POIN 500
//During each sweep, 500 trace points will be measured.
SENS:SWE:TIME 50ms
//Decouples the sweep time from the RBW,VBW and span and increases it to
//make the measurement more precise.

//-----Configuring Attenuation-----
//Only if electronic attenuator is available:
//INP:EATT:STAT ON
//Switches on the electronic attenuator.
//INP:EATT 5dB
//Sets the electronic attenuation to 5 dB.
//INP:ATT 0dB
//Sets the mechanical attenuation to 0 dB - makes a total of 5 dB attenuation
//otherwise:
INP:ATT 5 dB
//Sets the mechanical attenuation to 40 dB and couples the reference level
//to the attenuation instead of vice versa.

//-----Configuring the Amplitude and Scaling-----
DISP:TRAC1:Y:RLEV:OFFS 10dB
//Shifts the trace display in the diagram up by 10 dB.
CALC:UNIT:POW V
//Sets the unit of the y-axis to Volt. The reference level is now 70.711 mV.
DISP:TRAC1:Y:SPAC LOG
//Uses logarithmic scaling with absolute values (V).
DISP:TRAC1:Y 110dB
//Increases the displayed range of the y-axis to 110 dB.
DISP:TRAC1:Y:RPOS 80PCT
//Shifts the display of the reference level down, it is no longer the top line
//in the diagram. The reference level is displayed as a red line.

//-----Triggering-----
TRIG:SOUR IFP
TRIG:LEV:IFP -10dBm
TRIG:SLOP POS
TRIG:DTIM 50ms
TRIG:IFP:HYST 5dB
TRIG:HOLD 10ms
//Defines triggering when the second intermediate frequency rises to a level
//of -10 dBm, with a dropout time of 50 ms, a hysteresis of 5 dB and a delay
//of 10 ms.

SWE:EGAT ON
SWE:EGAT:TYPE EDGE

```

```

SWE:EGAT:LENG 5ms
//Defines gating. Values are measured for 5 ms after triggering.

//-----Configuring the Trace-----
DISP:TRAC2:MODE AVER
DISP:TRAC3:MODE MAXH
//Configures 3 traces: 1 (default): clear/write; 2: average; 3: max hold

SENS:DET1 POS
SENS:DET2 RMS
SENS:DET3 POS
//Configures traces 1 and 3 to use the positive peak detector; trace 2 uses
//the RMS detector.

TRAC:COPY TRACE4,TRACE1
//Copies trace 1 to a new trace 4 which will then be averaged.

SENS:AVER:STAT4 ON
SENS:AVER:COUN 10
SENS:AVER:TYPE LIN
//Configures trace 4 to be averaged linearly over 10 sweeps.

CALC:MATH:STAT ON
CALC:MATH:MODE LIN
CALC:MATH (TRACE1-TRACE2)
CALC:MATH:POS 75
//Calculates the linear difference between the measured and average values.
//The resulting trace is displayed at the top of the diagram.

//-----Performing the Measurement-----
INIT;*WAI
//Initiates a new measurement and waits until the last sweep has finished.

//-----Retrieving Results-----
TRAC:DATA? TRACE1
TRAC:DATA? TRACE2
TRAC:DATA? TRACE3
TRAC:DATA? TRACE4
//Returns one power value per sweep point for each trace.
TRAC:DATA:X?
//Returns one frequency value per sweep point for each trace.

```

## 9.7 Remote Commands for Result Displays

- [Working with Windows in the Display](#)..... 703
- [Examples: Configuring the Result Display](#)..... 709

### 9.7.1 Working with Windows in the Display

The following commands are required to change the evaluation type and rearrange the screen layout for a channel setup as you do using the SmartGrid in manual operation. Since the available evaluation types depend on the selected application, some parameters for the following commands also depend on the selected channel setup.

Note that the suffix <n> always refers to the window *in the currently selected channel setup* (see `INSTrument[:SElect]` on page 583).

|                                                     |     |
|-----------------------------------------------------|-----|
| <code>LAYout:ADD[:WINDow]?</code> .....             | 703 |
| <code>LAYout:CATalog[:WINDow]?</code> .....         | 704 |
| <code>LAYout:IDENtify[:WINDow]?</code> .....        | 704 |
| <code>LAYout:MOVE[:WINDow]</code> .....             | 705 |
| <code>LAYout:REMOve[:WINDow]</code> .....           | 705 |
| <code>LAYout:REPLace[:WINDow]</code> .....          | 706 |
| <code>LAYout:SPLitter</code> .....                  | 706 |
| <code>LAYout:WINDow&lt;n&gt;:ADD?</code> .....      | 707 |
| <code>LAYout:WINDow&lt;n&gt;:IDENtify?</code> ..... | 708 |
| <code>LAYout:WINDow&lt;n&gt;:REMOve</code> .....    | 708 |
| <code>LAYout:WINDow&lt;n&gt;:REPLace</code> .....   | 708 |

---

#### `LAYout:ADD[:WINDow]?` <WindowName>,<Direction>,<WindowType>

This command adds a window to the display in the active channel setup.

This command is always used as a query so that you immediately obtain the name of the new window as a result.

To replace an existing window, use the `LAYout:REPLace[:WINDow]` command.

#### Query parameters:

|              |                                                                                                                                                                                                                                                                 |
|--------------|-----------------------------------------------------------------------------------------------------------------------------------------------------------------------------------------------------------------------------------------------------------------|
| <WindowName> | String containing the name of the existing window the new window is inserted next to.<br>By default, the name of a window is the same as its index. To determine the name and index of all active windows, use the <code>LAYout:CATalog[:WINDow]?</code> query. |
| <Direction>  | LEFT   RIGHT   ABOVE   BELOW<br>Direction the new window is added relative to the existing window.                                                                                                                                                              |
| <WindowType> | text value<br>Type of result display (evaluation method) you want to add. See the table below for available parameter values.                                                                                                                                   |

#### Return values:

|                 |                                                                                                         |
|-----------------|---------------------------------------------------------------------------------------------------------|
| <NewWindowName> | When adding a new window, the command returns its name (by default the same as its number) as a result. |
|-----------------|---------------------------------------------------------------------------------------------------------|

- Example:** LAY:ADD? '1', LEFT, MTAB  
 Result:  
 '2'  
 Adds a new window named '2' with a marker table to the left of window 1.
- Usage:** Query only
- Manual operation:** See " [Diagram](#) " on page 260  
 See " [Marker Table](#) " on page 260  
 See " [Marker Peak List](#) " on page 261  
 See " [Result Summary](#) " on page 261  
 See " [Spectrogram](#) " on page 262

**Table 9-3: <WindowType> parameter values for the Spectrum application**

| Parameter value | Window type      |
|-----------------|------------------|
| DIAGram         | Diagram          |
| MTABle          | Marker table     |
| PEAKlist        | Marker peak list |
| RSUMmary        | Result summary   |
| SGRam           | Spectrogram      |

### LAYout:CATalog[:WINDow]?

This command queries the name and index of all active windows in the active channel setup from top left to bottom right. The result is a comma-separated list of values for each window, with the syntax:

<WindowName\_1>,<WindowIndex\_1>..<WindowName\_n>,<WindowIndex\_n>

**Return values:**

- <WindowName>      string  
 Name of the window.  
 In the default state, the name of the window is its index.
- <WindowIndex>    **numeric value**  
 Index of the window.

- Example:** LAY:CAT?  
 Result:  
 '2',2,'1',1  
 Two windows are displayed, named '2' (at the top or left), and '1' (at the bottom or right).

- Usage:** Query only

### LAYout:IDENtify[:WINDow]? <WindowName>

This command queries the **index** of a particular display window in the active channel setup.



**Note:** to query the **name** of a particular window, use the `LAYout:WINDow<n>:IDENTify?` query.

**Query parameters:**

<WindowName> String containing the name of a window.

**Return values:**

<WindowIndex> Index number of the window.

**Example:**

```
LAY:WIND:IDEN? '2'
```

Queries the index of the result display named '2'.

Response:

```
2
```

**Usage:** Query only

**LAYout:MOVE[:WINDow]** <WindowName>, <WindowName>, <Direction>

**Setting parameters:**

<WindowName> String containing the name of an existing window that is to be moved.  
By default, the name of a window is the same as its index. To determine the name and index of all active windows in the active channel setup, use the `LAYout:CATalog[:WINDow]?` query.

<WindowName> String containing the name of an existing window the selected window is placed next to or replaces.  
By default, the name of a window is the same as its index. To determine the name and index of all active windows in the active channel setup, use the `LAYout:CATalog[:WINDow]?` query.

<Direction> LEFT | RIGHT | ABOVE | BELOW | REPLACE  
Destination the selected window is moved to, relative to the reference window.

**Example:** `LAY:MOVE '4', '1', LEFT`  
Moves the window named '4' to the left of window 1.

**Example:** `LAY:MOVE '1', '3', REPL`  
Replaces the window named '3' by window 1. Window 3 is deleted.

**Usage:** Setting only

**LAYout:REMOve[:WINDow]** <WindowName>

**Setting parameters:**

<WindowName>

**Usage:** Setting only

**LAYout:REPLace[:WINDow]** <WindowName>, <WindowType>

This command replaces the window type (for example from "Diagram" to "Result Summary") of an already existing window in the active channel setup while keeping its position, index and window name.

To add a new window, use the `LAYout:ADD[:WINDow]?` command.

**Setting parameters:**

<WindowName> String containing the name of the existing window.  
By default, the name of a window is the same as its index. To determine the name and index of all active windows in the active channel setup, use the `LAYout:CATalog[:WINDow]?` query.

<WindowType> Type of result display you want to use in the existing window.  
See `LAYout:ADD[:WINDow]?` on page 703 for a list of available window types.

**Example:** `LAY:REPL:WIND '1',MTAB`  
Replaces the result display in window 1 with a marker table.

**Usage:** Setting only

**LAYout:SPLitter** <Index1>, <Index2>, <Position>

This command changes the position of a splitter and thus controls the size of the windows on each side of the splitter.

Note that windows must have a certain minimum size. If the position you define conflicts with the minimum size of any of the affected windows, the command will not work, but does not return an error.

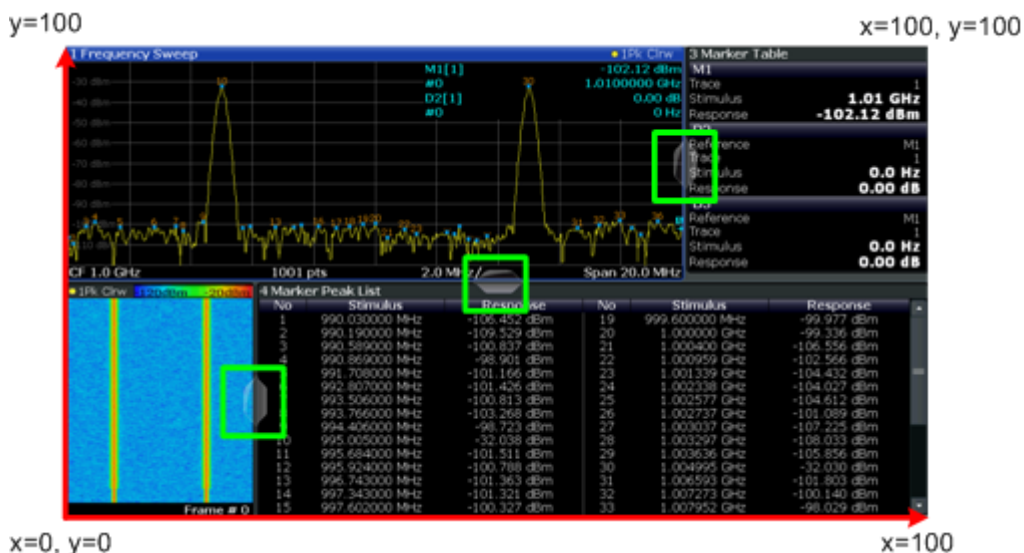

Figure 9-1: SmartGrid coordinates for remote control of the splitters

**Setting parameters:**

<Index1> The index of one window the splitter controls.

|                 |                                                                                                                                                                                                                                                                                                                                                                                                                                                                                                                                                                                                                             |
|-----------------|-----------------------------------------------------------------------------------------------------------------------------------------------------------------------------------------------------------------------------------------------------------------------------------------------------------------------------------------------------------------------------------------------------------------------------------------------------------------------------------------------------------------------------------------------------------------------------------------------------------------------------|
| <Index2>        | The index of a window on the other side of the splitter.                                                                                                                                                                                                                                                                                                                                                                                                                                                                                                                                                                    |
| <Position>      | <p>New vertical or horizontal position of the splitter as a fraction of the screen area (without channel and status bar and softkey menu).</p> <p>The point of origin (x = 0, y = 0) is in the lower left corner of the screen. The end point (x = 100, y = 100) is in the upper right corner of the screen. (See <a href="#">Figure 9-1</a>.)</p> <p>The direction in which the splitter is moved depends on the screen layout. If the windows are positioned horizontally, the splitter also moves horizontally. If the windows are positioned vertically, the splitter also moves vertically.</p> <p>Range: 0 to 100</p> |
| <b>Example:</b> | <pre>LAY:SPL 1,3,50</pre> <p>Moves the splitter between window 1 ('Frequency Sweep') and 3 ('Marker Table') to the center (50%) of the screen, i.e. in the figure above, to the left.</p>                                                                                                                                                                                                                                                                                                                                                                                                                                   |
| <b>Example:</b> | <pre>LAY:SPL 1,4,70</pre> <p>Moves the splitter between window 1 ('Frequency Sweep') and 3 ('Marker Peak List') towards the top (70%) of the screen.</p> <p>The following commands have the exact same effect, as any combination of windows above and below the splitter moves the splitter vertically.</p> <pre>LAY:SPL 3,2,70 LAY:SPL 4,1,70 LAY:SPL 2,1,70</pre>                                                                                                                                                                                                                                                        |
| <b>Usage:</b>   | Setting only                                                                                                                                                                                                                                                                                                                                                                                                                                                                                                                                                                                                                |

---

#### **LAYout:WINDow<n>:ADD? <Direction>,<WindowType>**

This command adds a measurement window to the display. Note that with this command, the suffix <n> determines the existing window next to which the new window is added, as opposed to [LAYout:ADD\[:WINDow\]?](#), for which the existing window is defined by a parameter.

To replace an existing window, use the [LAYout:WINDow<n>:REPLace](#) command.

This command is always used as a query so that you immediately obtain the name of the new window as a result.

**Suffix:**

<n> [Window](#)

**Query parameters:**

<Direction> LEFT | RIGHT | ABOVE | BELOW

<WindowType> Type of measurement window you want to add.  
See [LAYout:ADD\[:WINDow\]?](#) on page 703 for a list of available window types.

**Return values:**

<NewWindowName> When adding a new window, the command returns its name (by default the same as its number) as a result.

**Example:**

```
LAY:WIND1:ADD? LEFT,MTAB
```

Result:

```
'2'
```

Adds a new window named '2' with a marker table to the left of window 1.

**Usage:**

Query only

**LAYout:WINDow<n>:IDENTify?**

This command queries the **name** of a particular display window (indicated by the <n> suffix) in the active channel setup.

**Note:** to query the **index** of a particular window, use the [LAYout:IDENTify\[:WINDow\]?](#) command.

**Suffix:**

<n> [Window](#)

**Return values:**

<WindowName> String containing the name of a window.  
In the default state, the name of the window is its index.

**Example:**

```
LAY:WIND2:IDEN?
```

Queries the name of the result display in window 2.

Response:

```
'2'
```

**Usage:**

Query only

**LAYout:WINDow<n>:REMOve**

This command removes the window specified by the suffix <n> from the display in the active channel setup.

The result of this command is identical to the [LAYout:REMOve\[:WINDow\]](#) command.

**Suffix:**

<n> [Window](#)

**Example:**

```
LAY:WIND2:REM
```

Removes the result display in window 2.

**Usage:**

Event

**LAYout:WINDow<n>:REPLace <WindowType>**

This command changes the window type of an existing window (specified by the suffix <n>) in the active channel setup.

The effect of this command is identical to the `LAYout:REPLace[:WINDow]` command.

To add a new window, use the `LAYout:WINDow<n>:ADD?` command.

**Suffix:**

<n> Window

**Setting parameters:**

<WindowType> Type of measurement window you want to replace another one with.

See `LAYout:ADD[:WINDow]?` on page 703 for a list of available window types.

**Example:**

`LAY:WIND2:REPL MTAB`

Replaces the result display in window 2 with a marker table.

**Usage:**

Setting only

## 9.7.2 Examples: Configuring the Result Display

The following example demonstrates how to configure result displays in a remote environment.

### 9.7.2.1 Example 1: Adding and Arranging Windows

Starting from the default initial display in the Spectrum application (Frequency Sweep), we will configure the following result displays:

|                   |                    |
|-------------------|--------------------|
| 1 Frequency Sweep | 3 Marker Table     |
| 2 Spectrogram     | 4 Marker Peak List |

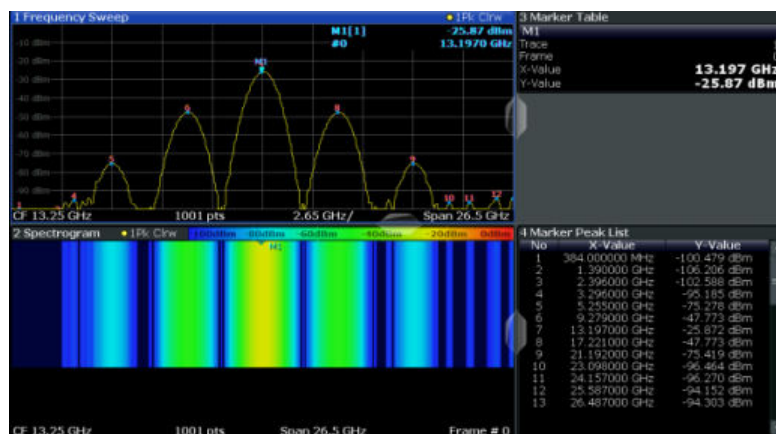

```
//-----Resetting the instrument -----
*RST
//----- Adding new windows -----
//Add a Spectrogram window beneath the Frequency Sweep window
```

```

LAY:ADD? '1',BEL,SGR
//Result: window number: '2'
//Add a Marker Table window to the right of the Frequency Sweep window
LAY:ADD? '1',RIGH,MTAB
//Result: window number: '3'
//Add a Marker Peak List window to the right of the Spectrogram window
LAY:WIND2:ADD? RIGH,PEAK
//Result: window number: '4'

//----- Changing the size of individual windows -----
//Move the splitter between the Frequency Sweep window and the Marker Table
//window to enlarge the spectrum display to 60% of the entire width.
LAY:SPL 1,3,60
//Move the splitter between the Spectrogram window and the Marker Peak List
//window to enlarge the Spectrogram display to 60% of the entire width.
LAY:SPL 2,4,60

//----- Querying all displayed windows -----
//Query the name and number of all displayed windows
//(from top left to bottom right)
LAY:CAT?
//Result : '1',1,'2',2,'3',3,'4',4

//----- Maximizing a Window -----
//Maximize the window "2 Spectrogram"
DISP:WIND2:SIZE LARG

//-----Restore multiple window display -----
DISP:WIND2:SIZE SMAL

```

### 9.7.2.2 Example 2: Replacing and Removing Windows

Starting from the display configured in [Example 1: Adding and Arranging Windows](#), we will remove and replace result displays to obtain the following configuration:

|                   |
|-------------------|
| 1 Frequency Sweep |
| 4 Marker Table    |

## Setting Basic Spectrum RF Measurement Parameters

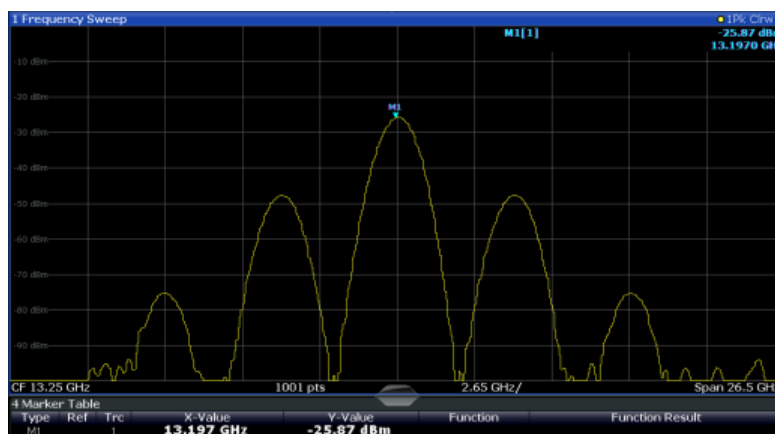

```
//----- Preparing the configuration from example 1 -----
*RST
LAY:ADD? '1',BEL,SGR
LAY:ADD? '1',RIGH,MTAB
LAY:WIND2:ADD? RIGH,PEAK
LAY:CAT?
//Result : '1',1,'2',2,'3',3,'4',4
//Remove Spectrogram
LAY:WIND2:REM //Remove Marker Table window
LAY:REM '3'
//Replace Marker Peak List window by Marker Table
LAY:REPL '4',MTAB

//----- Querying all displayed windows -----
//Query the name and number of all displayed windows (from top left to bottom right)
LAY:CAT?
//Result : '1',1,'4',4

//----- Changing the size of individual windows -----
//Move the splitter between the Frequency Sweep window and the Marker Table window
//to enlarge the spectrum display to 80% of the entire height.
LAY:SPL 1,4,80
```

## 9.8 Setting Basic Spectrum RF Measurement Parameters

Commands required for common spectrum RF measurements are described here.

- [Defining the Frequency and Span](#).....712
- [Configuring Bandwidth and Sweep Settings](#).....721
- [Configuring the Vertical Axis \(Amplitude, Scaling\)](#).....729
- [Configuring Triggered and Gated Measurements](#).....734
- [Configuring the Data Input and Output](#).....741
- [Zooming into the Display](#).....756

- [Configuring the Trace Display and Retrieving Trace Data](#)..... 759
- [Working with Markers](#).....784
- [Configuring Display and Limit Lines](#).....843

## 9.8.1 Defining the Frequency and Span

The commands required to configure the frequency and span settings in a remote environment are described here. The tasks for manual operation are described in [Chapter 8.4, "Frequency and Span Configuration"](#), on page 418.

- [Defining the Frequency Range](#)..... 712
- [Adjusting Settings Automatically](#).....716
- [Configuring Signal Tracking](#)..... 720

### 9.8.1.1 Defining the Frequency Range

The following commands are required to define the frequency range.

|                                                                                               |     |
|-----------------------------------------------------------------------------------------------|-----|
| <a href="#">CALCulate&lt;n&gt;:MARKer&lt;m&gt;:FUNCtion:CENTer</a> .....                      | 712 |
| <a href="#">CALCulate&lt;n&gt;:MARKer&lt;m&gt;:FUNCtion:CSep</a> .....                        | 713 |
| <a href="#">DISPlay[:WINDow&lt;n&gt;][:SUBWindow&lt;w&gt;]:TRACe&lt;t&gt;:X:SPACing</a> ..... | 713 |
| <a href="#">[SENSe:]FREQuency:CENTer</a> .....                                                | 713 |
| <a href="#">[SENSe:]FREQuency:CENTer:STEP</a> .....                                           | 714 |
| <a href="#">[SENSe:]FREQuency:CENTer:STEP:AUTO</a> .....                                      | 714 |
| <a href="#">[SENSe:]FREQuency:CENTer:STEP:LINK</a> .....                                      | 714 |
| <a href="#">[SENSe:]FREQuency:CENTer:STEP:LINK:FACTor</a> .....                               | 715 |
| <a href="#">[SENSe:]FREQuency:OFFSet</a> .....                                                | 715 |
| <a href="#">[SENSe:]FREQuency:SPAN</a> .....                                                  | 715 |
| <a href="#">[SENSe:]FREQuency:SPAN:FULL</a> .....                                             | 716 |
| <a href="#">[SENSe:]FREQuency:STARt</a> .....                                                 | 716 |
| <a href="#">[SENSe:]FREQuency:STOP</a> .....                                                  | 716 |

---

#### **CALCulate<n>:MARKer<m>:FUNCtion:CENTer**

This command matches the center frequency to the frequency of a marker.

If you use the command in combination with a delta marker, that delta marker is turned into a normal marker.

#### **Suffix:**

<n>                      [Window](#)

<m>                      [Marker](#)

#### **Example:**

`CALC:MARK2:FUNC:CENT`

Sets the center frequency to the frequency of marker 2.

**Manual operation:** See "[Center Frequency = Marker Frequency](#)" on page 479



**CALCulate<n>:MARKer<m>:FUNction:CSTep**

This command matches the center frequency step size to the current marker frequency.

The command turns delta markers into normal markers.

**Suffix:**

<n>                    Window  
<m>                    Marker

**DISPlay[:WINDow<n>][:SUBWindow<w>]:TRACe<t>:X:SPACing <Scale>**

This command selects the scaling of the x-axis.

**Suffix:**

<n>                    Window  
<w>                    subwindow  
<t>

**Parameters:**

<Scale>              **LOGarithmic**  
                          Logarithmic scaling.  
                          **LINear**  
                          Linear scaling.  
                          \*RST:        LINear

**Example:**            DISP:TRAC:X:SPAC LOG

**Manual operation:** See " [Frequency Axis Scaling](#) " on page 401

**[SENSe:]FREQuency:CENTer <Frequency>**

This command defines the center frequency.

**Parameters:**

<Frequency>        The allowed range and  $f_{max}$  is specified in the data sheet.

**UP**

Increases the center frequency by the step defined using the [\[SENSe:\]FREQuency:CENTer:STEP](#) command.

**DOWN**

Decreases the center frequency by the step defined using the [\[SENSe:\]FREQuency:CENTer:STEP](#) command.

\*RST:         $f_{max}/2$

Default unit: Hz

**Example:**

```
FREQ:CENT 100 MHz
FREQ:CENT:STEP 10 MHz
FREQ:CENT UP
Sets the center frequency to 110 MHz.
```

**Manual operation:** See " [Center Frequency](#) " on page 422  
See " [Frequency](#) " on page 454

---

#### [SENSe:]FREQUENCY:CENTer:STEP <StepSize>

This command defines the center frequency step size.

You can increase or decrease the center frequency quickly in fixed steps using the SENS:FREQ UP AND SENS:FREQ DOWN commands, see [[SENSe:](#)] [FREQUENCY:CENTer](#) on page 713.

#### Parameters:

<StepSize>  $f_{max}$  is specified in the data sheet.  
Range: 1 to fMAX  
\*RST: 0.1 x span  
Default unit: Hz

#### Example:

```
//Set the center frequency to 110 MHz.
FREQ:CENT 100 MHz
FREQ:CENT:STEP 10 MHz
FREQ:CENT UP
```

**Manual operation:** See " [Center Frequency Stepsize](#) " on page 423

---

#### [SENSe:]FREQUENCY:CENTer:STEP:AUTO <State>

This command couples or decouples the center frequency step size to the span.

In time domain (zero span) measurements, the center frequency is coupled to the RBW.

#### Parameters:

<State> ON | OFF | 0 | 1  
\*RST: 1

#### Example:

```
FREQ:CENT:STEP:AUTO ON
Activates the coupling of the step size to the span.
```

---

#### [SENSe:]FREQUENCY:CENTer:STEP:LINK <CouplingType>

This command couples and decouples the center frequency step size to the span or the resolution bandwidth.

#### Parameters:

<CouplingType> SPAN | RBW | OFF

#### SPAN

Couples the step size to the span. Available for measurements in the frequency domain.

#### RBW

Couples the step size to the resolution bandwidth. Available for measurements in the time domain.

**OFF**

Decouples the step size.

\*RST: SPAN

**Example:** //Couple step size to span  
FREQ:CENT:STEP:LINK SPAN

**Manual operation:** See "[Center Frequency Stepsize](#)" on page 423

**[SENSe:]FREQuency:CENTer:STEP:LINK:FACTor <Factor>**

This command defines a step size factor if the center frequency step size is coupled to the span or the resolution bandwidth.

**Parameters:**

<Factor> 1 to 100 PCT  
\*RST: 10  
Default unit: PCT

**Example:** //Couple frequency step size to span and define a step size factor  
FREQ:CENT:STEP:LINK SPAN  
FREQ:CENT:STEP:LINK:FACT 20PCT

**Manual operation:** See "[Center Frequency Stepsize](#)" on page 423

**[SENSe:]FREQuency:OFFSet <Offset>**

This command defines a frequency offset.

If this value is not 0 Hz, the application assumes that the input signal was frequency shifted outside the application. All results of type "frequency" will be corrected for this shift numerically by the application.

See also "[Frequency Offset](#)" on page 424.

**Parameters:**

<Offset> Range: -100 GHz to 100 GHz  
\*RST: 0 Hz  
Default unit: HZ

**Example:** FREQ:OFFS 1GHZ

**Manual operation:** See "[Frequency Offset](#)" on page 424

**[SENSe:]FREQuency:SPAN <Span>**

This command defines the frequency span.

If you set a span of 0 Hz in the Spectrum application, the R&S FPL1000 starts a measurement in the time domain.

**Parameters:**

<Span> The minimum span for measurements in the frequency domain is 10 Hz.  
 For SEM and spurious emission measurements, the minimum span is 20 Hz.  
 Range: 0 Hz to fmax  
 \*RST: Full span  
 Default unit: Hz

**Manual operation:** See " [Zero Span](#) " on page 240  
 See " [Span](#) " on page 422  
 See " [Zero Span](#) " on page 423  
 See " [Last Span](#) " on page 423

**[SENSe:]FREQuency:SPAN:FULL**

This command restores the full span.

**Manual operation:** See " [Full Span](#) " on page 422

**[SENSe:]FREQuency:STARt <Frequency>**

This command defines a start frequency for measurements in the frequency domain.

**Parameters:**

<Frequency> 0 to (fmax - min span)  
 \*RST: 0  
 Default unit: HZ

**Example:** `FREQ:STAR 20MHz`

**Manual operation:** See " [Frequency Sweep](#) " on page 240  
 See " [Start / Stop](#) " on page 422

**[SENSe:]FREQuency:STOP <Frequency>**

This command defines a stop frequency for measurements in the frequency domain.

**Parameters:**

<Frequency> min span to fmax  
 \*RST: fmax  
 Default unit: HZ

**Example:** `FREQ:STOP 2000 MHz`

**Manual operation:** See " [Frequency Sweep](#) " on page 240  
 See " [Start / Stop](#) " on page 422

**9.8.1.2 Adjusting Settings Automatically**

The commands required to adjust settings automatically in a remote environment are described here.

|                                                |     |
|------------------------------------------------|-----|
| [SENSe:]ADJust:ALL.....                        | 717 |
| [SENSe:]ADJust:CONFigure:DURation.....         | 717 |
| [SENSe:]ADJust:CONFigure:DURation:MODE.....    | 718 |
| [SENSe:]ADJust:CONFigure:HYSTeresis:LOWer..... | 718 |
| [SENSe:]ADJust:CONFigure:HYSTeresis:UPPer..... | 718 |
| [SENSe:]ADJust:CONFigure:TRIGger.....          | 719 |
| [SENSe:]ADJust:FREQUency.....                  | 719 |
| [SENSe:]ADJust:LEVel.....                      | 719 |

---

### [SENSe:]ADJust:ALL

This command initiates a measurement to determine and set the ideal settings for the current task automatically (only once for the current measurement).

This includes:

- Center frequency
- Reference level

**Example:**           ADJ:ALL

**Manual operation:** See "[Adjusting all Determinable Settings Automatically \( Auto All \)](#)" on page 462

---

### [SENSe:]ADJust:CONFigure:DURation <Duration>

In order to determine the ideal reference level, the R&S FPL1000 performs a measurement on the current input data. This command defines the length of the measurement if [SENSe:]ADJust:CONFigure:DURation:MODE is set to MANual.

#### Parameters:

<Duration>           Numeric value in seconds  
 Range:           0.001 to 16000.0  
 \*RST:           0.001  
 Default unit: s

**Example:**           ADJ:CONF:DUR:MODE MAN  
 Selects manual definition of the measurement length.  
 ADJ:CONF:LEV:DUR 5ms  
 Length of the measurement is 5 ms.

**Manual operation:** See "[Changing the Automatic Measurement Time \( MeasTime Manual \)](#)" on page 462

**[SENSe:]ADJust:CONFigure:DURation:MODE <Mode>**

In order to determine the ideal reference level, the R&S FPL1000 performs a measurement on the current input data. This command selects the way the R&S FPL1000 determines the length of the measurement .

**Parameters:**

&lt;Mode&gt;

**AUTO**

The R&S FPL1000 determines the measurement length automatically according to the current input data.

**MANual**

The R&S FPL1000 uses the measurement length defined by [\[SENSe:\]ADJust:CONFigure:DURation](#) on page 717.

\*RST: AUTO

**Manual operation:** See "[Resetting the Automatic Measurement Time \( Meastime Auto \)](#)" on page 462  
See "[Changing the Automatic Measurement Time \( Meastime Manual \)](#)" on page 462

**[SENSe:]ADJust:CONFigure:HYSTeresis:LOWer <Threshold>**

When the reference level is adjusted automatically using the [\[SENSe:\]ADJust:LEVel](#) on page 719 command, the internal attenuators and the preamplifier are also adjusted. In order to avoid frequent adaptation due to small changes in the input signal, you can define a hysteresis. This setting defines a lower threshold the signal must fall below (compared to the last measurement) before the reference level is adapted automatically.

**Parameters:**

&lt;Threshold&gt;

Range: 0 dB to 200 dB

\*RST: +1 dB

Default unit: dB

**Example:**

```
SENS:ADJ:CONF:HYST:LOW 2
```

For an input signal level of currently 20 dBm, the reference level will only be adjusted when the signal level falls below 18 dBm.

**Manual operation:** See "[Lower Level Hysteresis](#)" on page 463

**[SENSe:]ADJust:CONFigure:HYSTeresis:UPPer <Threshold>**

When the reference level is adjusted automatically using the [\[SENSe:\]ADJust:LEVel](#) on page 719 command, the internal attenuators and the preamplifier are also adjusted. In order to avoid frequent adaptation due to small changes in the input signal, you can define a hysteresis. This setting defines an upper threshold the signal must exceed (compared to the last measurement) before the reference level is adapted automatically.

## Setting Basic Spectrum RF Measurement Parameters

**Parameters:**

<Threshold>            Range:     0 dB to 200 dB  
                              \*RST:     +1 dB  
                              Default unit: dB

**Example:**            SENS:ADJ:CONF:HYST:UPP 2

**Example:**            For an input signal level of currently 20 dBm, the reference level will only be adjusted when the signal level rises above 22 dBm.

**Manual operation:**   See "[Upper Level Hysteresis](#)" on page 463

**[SENSe:]ADJust:CONFigure:TRIGger <State>**

Defines the behavior of the measurement when adjusting a setting automatically (using SENS:ADJ:LEV ON, for example).

See "[Adjusting settings automatically during triggered measurements](#)" on page 461.

**Parameters:**

<State>                ON | OFF | 0 | 1  
                              **OFF | 0**  
                              Switches the function off  
                              **ON | 1**  
                              Switches the function on

**[SENSe:]ADJust:FREQuency**

This command sets the center frequency to the frequency with the highest signal level in the current frequency range.

**Example:**            ADJ:FREQ

**Manual operation:**   See "[Adjusting the Center Frequency Automatically \( Auto Frequency \)](#)" on page 462

**[SENSe:]ADJust:LEVel**

This command initiates a single (internal) measurement that evaluates and sets the ideal reference level for the current input data and measurement settings. This ensures that the settings of the RF attenuation and the reference level are optimally adjusted to the signal level without overloading the R&S FPL1000 or limiting the dynamic range by an S/N ratio that is too small.

**Example:**            ADJ:LEV

**Manual operation:**   See "[Setting the Reference Level Automatically \( Auto Level \)](#)" on page 431

### 9.8.1.3 Configuring Signal Tracking

When signal tracking is activated, the maximum signal is determined after each frequency sweep and the center frequency is set to the frequency of this signal. Thus with drifting signals the center frequency follows the signal.

For more details see [Chapter 8.4.1, "Impact of the Frequency and Span Settings"](#), on page 418..

|                                                       |     |
|-------------------------------------------------------|-----|
| CALCulate<n>:MARKer<m>:FUNction:STRack[:STATe].....   | 720 |
| CALCulate<n>:MARKer<m>:FUNction:STRack:BANDwidth..... | 720 |
| CALCulate<n>:MARKer<m>:FUNction:STRack:THReshold..... | 721 |
| CALCulate<n>:MARKer<m>:FUNction:STRack:TRACe.....     | 721 |

---

#### CALCulate<n>:MARKer<m>:FUNction:STRack[:STATe] <State>

This command turns signal tracking on and off.

##### Suffix:

|     |            |
|-----|------------|
| <n> | irrelevant |
| <m> | irrelevant |

##### Parameters:

|         |                           |
|---------|---------------------------|
| <State> | ON   OFF   0   1          |
|         | <b>OFF   0</b>            |
|         | Switches the function off |
|         | <b>ON   1</b>             |
|         | Switches the function on  |

##### Example:

```
//Activate signal tracking to keep the center frequency on the signal peak
//After each sweep the maximum on trace 1 is searched within a range of 20MHz
//around the center frequency. It must have a minimum power of -90dBm.
CALC:MARK:FUNC:STR ON
CALC:MARK:FUNC:STR:BAND 20MHz
CALC:MARK:FUNC:STR:THR -90dBm
CALC:MARK:FUNC:STR:TRAC 1
```

**Manual operation:** See "[Signal Tracking](#)" on page 424

---

#### CALCulate<n>:MARKer<m>:FUNction:STRack:BANDwidth <Bandwidth>

This command defines the bandwidth around the center frequency that is included in the signal tracking process.

Note that you have to turn on signal tracking before you can use the command.

##### Suffix:

|     |            |
|-----|------------|
| <n> | irrelevant |
| <m> | irrelevant |



**Parameters:**

<Bandwidth>            Range:        10 Hz to Max span  
                               \*RST:        (= span/10 on activating the function)  
                               Default unit: Hz

**Manual operation:** See " [Signal Tracking](#) " on page 424

**CALCulate<n>:MARKer<m>:FUNCTION:STRack:THREshold <Level>**

This command defines the threshold level for the signal tracking process.

Note that you have to turn on signal tracking before you can use the command.

**Suffix:**

<n>                        irrelevant  
 <m>                        irrelevant

**Parameters:**

<Level>                 The unit depends on [CALCulate<n>:UNIT:POWer](#).  
                               Range:        -130 dBm to 30 dBm  
                               \*RST:        -120 dBm  
                               Default unit: DBM

**Manual operation:** See " [Signal Tracking](#) " on page 424

**CALCulate<n>:MARKer<m>:FUNCTION:STRack:TRACe <TraceNumber>**

This command selects the trace on which the largest signal is searched for.

**Suffix:**

<n>                        irrelevant  
 <m>                        irrelevant

**Parameters:**

<TraceNumber>        1 to 6  
                               Range:        1 to 6  
                               \*RST:        1

**Manual operation:** See " [Signal Tracking](#) " on page 424

## 9.8.2 Configuring Bandwidth and Sweep Settings

The commands required to configure the bandwidth, sweep and filter settings in a remote environment are described here. The tasks for manual operation are described in [Chapter 8.6, "Bandwidth, Filter and Sweep Configuration"](#), on page 434.

- [Configuring the Bandwidth and Filter](#).....722
- [Configuring the Sweep](#).....725

### 9.8.2.1 Configuring the Bandwidth and Filter

|                                      |     |
|--------------------------------------|-----|
| [SENSe:]BWIDth[:RESolution]          | 722 |
| [SENSe:]BANDwidth[:RESolution]       | 722 |
| [SENSe:]BWIDth[:RESolution]:AUTO     | 722 |
| [SENSe:]BANDwidth[:RESolution]:AUTO  | 722 |
| [SENSe:]BWIDth[:RESolution]:RATio    | 723 |
| [SENSe:]BANDwidth[:RESolution]:RATio | 723 |
| [SENSe:]BWIDth[:RESolution]:TYPE     | 723 |
| [SENSe:]BANDwidth[:RESolution]:TYPE  | 723 |
| [SENSe:]BWIDth:VIDeo                 | 724 |
| [SENSe:]BANDwidth:VIDeo              | 724 |
| [SENSe:]BWIDth:VIDeo:AUTO            | 724 |
| [SENSe:]BANDwidth:VIDeo:AUTO         | 724 |
| [SENSe:]BWIDth:VIDeo:RATio           | 724 |
| [SENSe:]BANDwidth:VIDeo:RATio        | 724 |
| [SENSe:]BWIDth:VIDeo:TYPE            | 725 |
| [SENSe:]BANDwidth:VIDeo:TYPE         | 725 |

---

**[SENSe:]BWIDth[:RESolution]** <Bandwidth>

**[SENSe:]BANDwidth[:RESolution]** <Bandwidth>

This command defines the resolution bandwidth and decouples the resolution bandwidth from the span.

For statistics measurements, this command defines the **demodulation** bandwidth.

**Parameters:**

<Bandwidth> refer to data sheet  
 \*RST: RBW: AUTO is set to ON; DBW: 3MHz  
 Default unit: Hz

**Example:**

BAND 1 MHz  
 Sets the resolution bandwidth to 1 MHz

**Manual operation:**

See " [Analysis Bandwidth](#) " on page 352  
 See " [RBW](#) " on page 401  
 See " [Res BW CISPR](#) " on page 402  
 See " [Res BW MIL](#) " on page 402  
 See " [RBW](#) " on page 454

---

**[SENSe:]BWIDth[:RESolution]:AUTO** <State>

**[SENSe:]BANDwidth[:RESolution]:AUTO** <State>

This command couples and decouples the resolution bandwidth to the span.

**Parameters:**

<State> ON | OFF | 0 | 1  
 \*RST: 1

**Example:**

BAND:AUTO OFF  
 Switches off the coupling of the resolution bandwidth to the span.

**Manual operation:** See " [RBW](#) " on page 401  
See " [Default Coupling](#) " on page 444

---

**[SENSe:]BWIDth[:RESolution]:RATio** <Ratio>

**[SENSe:]BANDwidth[:RESolution]:RATio** <Ratio>

This command defines the ratio between the resolution bandwidth (Hz) and the span (Hz).

Note that the ratio defined with this remote command (RBW/span) is reciprocal to that of the coupling ratio (span/RBW).

**Parameters:**

<Ratio>                      Range:        0.0001 to 1  
                                  \*RST:        0.01

**Example:**                    BAND:RAT 0.1

**Manual operation:** See " [Span/RBW](#) " on page 443

---

**[SENSe:]BWIDth[:RESolution]:TYPE** <FilterType>

**[SENSe:]BANDwidth[:RESolution]:TYPE** <FilterType>

This command selects the resolution filter type.

When you change the filter type, the command selects the next larger filter bandwidth if the same bandwidth is unavailable for that filter.

The EMI-specific filter types are available if the EMI (R&S FPL1-K54) measurement option is installed, even if EMI measurement is not active. For details see "[Resolution Bandwidth and Filter Types](#)" on page 388.

**Parameters:**

<FilterType>

- CFILter**  
Channel filters
- NORMal**  
Gaussian filters
- P5**  
5-pole filters  
The 5-pole filter is not available for FFT sweeps.
- RRC**  
RRC filters
- CISPr | PULSe**  
CISPR (6 dB) - requires EMI (R&S FPL1-K54) option  
Return value for query is always *PULS*.
- MIL**  
MIL Std (6 dB) - requires EMI (R&S FPL1-K54) option
- \*RST:        NORMal

**Example:**                    BAND:TYPE NORM

**Manual operation:** See " [Filter Type](#) " on page 400  
 See " [Res BW CISPR](#) " on page 402  
 See " [Res BW MIL](#) " on page 402

---

**[SENSe:]BWIDth:VIDeo** <Bandwidth>

**[SENSe:]BANDwidth:VIDeo** <Bandwidth>

This command defines the video bandwidth.

The command decouples the video bandwidth from the resolution bandwidths.

**Parameters:**

<Bandwidth> refer to data sheet  
 \*RST: AUTO is set to ON  
 Default unit: HZ

**Example:** BAND:VID 10 kHz

**Manual operation:** See " [VBW](#) " on page 442

---

**[SENSe:]BWIDth:VIDeo:AUTO** <State>

**[SENSe:]BANDwidth:VIDeo:AUTO** <State>

This command couples and decouples the video bandwidth to the resolution bandwidth.

**Parameters:**

<State> ON | OFF | 0 | 1  
 \*RST: 1

**Example:** BAND:VID:AUTO OFF

**Manual operation:** See " [VBW](#) " on page 442  
 See " [RBW/VBW](#) " on page 443  
 See " [Default Coupling](#) " on page 444

---

**[SENSe:]BWIDth:VIDeo:RATio** <Ratio>

**[SENSe:]BANDwidth:VIDeo:RATio** <Ratio>

This command defines the coupling ratio of the video bandwidth to the resolution bandwidth (RBW/VBW).

**Parameters:**

<Ratio> Range: 0,001 to 1000  
 \*RST: 1

**Example:** BAND:VID:RAT 3  
 Sets the coupling of video bandwidth to video bandwidth =  
 3\*resolution bandwidth

**Manual operation:** See " [RBW/VBW](#) " on page 443

---

```
[SENSe:]BWIDth:VIDeo:TYPE <Mode>
[SENSe:]BANDwidth:VIDeo:TYPE <Mode>
```

This command selects the position of the video filter in the signal path.

**Parameters:**

<Mode>

**LINEar**

The video filter is applied in front of the logarithmic amplifier. In linear mode, measurements with a logarithmic level scale result in flatter falling edges compared to logarithmic mode. The reason is the conversion of linear power values into logarithmic level values: if you halve the linear power, the logarithmic level decreases by 3 dB.

**LOGarithmic**

The video filter is applied after the logarithmic amplifier

\*RST: LOGarithmic

**Example:**

```
BAND:VID:TYPE LIN
```

Video filter ahead of the logarithmic amplifier

### 9.8.2.2 Configuring the Sweep

Useful commands for configuring sweeps described elsewhere:

- [SENSe:]AVERAge<n>:COUNT on page 763
- [SENSe:]AVERAge<n>[:STATe<t>] on page 763
- [SENSe:]AVERAge<n>:TYPE on page 764

**Remote commands exclusive to configuring sweeps:**

|                                       |     |
|---------------------------------------|-----|
| [SENSe:]SWEep:COUNT.....              | 725 |
| [SENSe:]SWEep:DURation?.....          | 726 |
| [SENSe:]SWEep:OPTimize.....           | 726 |
| [SENSe:]SWEep[:WINDow<n>]:POINts..... | 727 |
| [SENSe:]SWEep:TIME.....               | 728 |
| [SENSe:]SWEep:TIME:AUTO.....          | 728 |
| [SENSe:]SWEep:TYPE:USED.....          | 728 |

---

```
[SENSe:]SWEep:COUNT <SweepCount>
```

This command defines the number of sweeps that the application uses to average traces.

In continuous sweep mode, the application calculates the moving average over the average count.

In single sweep mode, the application stops the measurement and calculates the average after the average count has been reached.

**Parameters:**

<SweepCount> When you set a sweep count of 0 or 1, the R&S FPL1000 performs one single sweep in single sweep mode. In continuous sweep mode, if the sweep count is set to 0, a moving average over 10 sweeps is performed.

Range: 0 to 200000  
\*RST: 0

**Example:**

```
SWE:COUN 64
Sets the number of sweeps to 64.
INIT:CONT OFF
Switches to single sweep mode.
INIT;*WAI
Starts a sweep and waits for its end.
```

**Manual operation:** See "[Sweep/Average Count](#)" on page 444

**[SENSe:]SWEep:DURation? <Time>**

This command provides an estimation of the total time required to capture the data and process it. This time span may be considerably longer than the actual sweep time (see [\[SENSe:\]SWEep:TIME](#) on page 728).

**Tip:** To determine the necessary timeout for data capturing in a remote control program, double the estimated time and add 1 second.

**Return values:**

<Time>

**Example:**

```
SWE:TIME 1s
SWE:DUR?
Reply:
27.9734842578
```

**Usage:** Query only

**Manual operation:** See "[Sweep Time](#)" on page 442  
See "[Data capturing takes too long](#)" on page 966

**[SENSe:]SWEep:OPTimize <Mode>**

In FFT mode, several FFT analysis steps are required to cover the entire measurement span. The span which is covered by one FFT analysis step is called *partial span*. The partial span cannot be defined directly, but it can be optimized according to measurement requirements.

**Table 9-4: Optimization parameters in FFT mode**

| Optimization mode | Description                                                                                                                                                                                                                                                                                                                                                                       |
|-------------------|-----------------------------------------------------------------------------------------------------------------------------------------------------------------------------------------------------------------------------------------------------------------------------------------------------------------------------------------------------------------------------------|
| DYNamic           | Optimizes the dynamic range by using the narrowest possible partial span (depending on the RBW).<br>The autorange function for the internal IF gain calculation is activated to obtain the best control range for the A/D converter.                                                                                                                                              |
| SPEed             | Optimizes the sweep rate by using the widest possible partial span (depending on the RBW).<br>The autorange function for the internal IF gain calculation is deactivated. (Note: set the reference level accordingly to optimize the control range for the A/D converter).<br>It is recommended that you set the <a href="#">Sweep Time</a> to "Auto" to optimize the sweep rate. |
| AUTO              | Uses a medium-sized partial span to obtain a compromise between a large dynamic range and a fast sweep rate.<br>The autorange function for the internal IF gain calculation is activated to obtain the best control range for the A/D converter.                                                                                                                                  |

**Zero span mode**

For zero span measurements, the optimization mode defines the selection of the A/D converter prefilter.

**Table 9-5: Optimization parameters in zero span mode**

| Optimization mode | Description                                                   |
|-------------------|---------------------------------------------------------------|
| DYNamic           | The narrowest filter possible (depending on the RBW) is used. |
| SPEed             | The widest filter possible (depending on the RBW) is used.    |
| AUTO              | A medium-sized prefilter is used.                             |

**Parameters:**

<Mode>                    \*RST:        AUTO

**Example:**

SWE:OPT DYN  
Selects optimization for dynamic range.

**Manual operation:** See "[Optimization](#)" on page 445

---

**[SENSe:]SWEep[:WINDow<n>]:POINTs <SweepPoints>**

This command defines the number of sweep points to analyze after a sweep.

Note that the number of sweep points is limited to 10001 when measuring spurious emissions.

**Suffix:**

<n>

**Parameters:**

<SweepPoints>        Range:        101 to 100001  
                             \*RST:        1001

**Example:**

SWE:POIN 251

**Manual operation:** See "[Sweep Points](#)" on page 444

---

#### [SENSe:]SWEep:TIME <Time>

This command defines the sweep time. It automatically decouples the time from any other settings.

In the Spectrum application, the command decouples the sweep time from the span and resolution and video bandwidths. Note that this command queries only the time required to capture the data, not to process it. To obtain an estimation of the total capture and processing time, use the [SENSe:]SWEep:DUration? command.

#### Parameters:

<Time> refer to data sheet  
 \*RST: depends on current settings (determined automatically)  
 Default unit: S

**Manual operation:** See "[Sweep Time](#)" on page 273  
 See "[Sweep Time](#)" on page 442  
 See "[Sweep Time](#)" on page 454

---

#### [SENSe:]SWEep:TIME:AUTO <State>

This command couples and decouples the sweep time to the span and the resolution and video bandwidths.

#### Parameters:

<State> ON | OFF | 0 | 1  
 \*RST: 1

**Example:** SWE:TIME:AUTO ON  
 Activates automatic sweep time.

**Manual operation:** See "[Harmonic Sweep Time](#)" on page 371  
 See "[Sweep Time](#)" on page 442  
 See "[Default Coupling](#)" on page 444

---

#### [SENSe:]SWEep:TYPE:USED

This command queries the sweep type if you have turned on automatic selection of the sweep type.

#### Return values:

<Type> **SWE**  
 Normal sweep  
**FFT**  
 FFT mode



### 9.8.3 Configuring the Vertical Axis (Amplitude, Scaling)

The following commands are required to configure the amplitude and vertical axis settings in a remote environment.

- [Amplitude Settings](#)..... 729
- [Configuring the Attenuation](#)..... 731
- [Configuring a Preamplifier](#)..... 732
- [Scaling the Y-Axis](#)..... 732

#### 9.8.3.1 Amplitude Settings

The tasks for manual configuration are described in [Chapter 8.5.2, "Amplitude Settings"](#), on page 429.

**Useful commands for amplitude configuration described elsewhere:**

- [\[SENSe:\]ADJust:LEVel](#) on page 719

**Remote commands exclusive to amplitude configuration:**

|                                                                                        |     |
|----------------------------------------------------------------------------------------|-----|
| <a href="#">CALCulate&lt;n&gt;:MARKer&lt;m&gt;:FUNction:REFerence</a> .....            | 729 |
| <a href="#">CALCulate&lt;n&gt;:UNIT:POWer</a> .....                                    | 729 |
| <a href="#">UNIT&lt;n&gt;:POWer</a> .....                                              | 729 |
| <a href="#">DISPlay[:WINDow&lt;n&gt;]:TRACe&lt;t&gt;:Y[:SCALe]:RLEVel</a> .....        | 730 |
| <a href="#">DISPlay[:WINDow&lt;n&gt;]:TRACe&lt;t&gt;:Y[:SCALe]:RLEVel:OFFSet</a> ..... | 730 |

---

#### **CALCulate<n>:MARKer<m>:FUNction:REFerence**

This command matches the reference level to the power level of a marker.

If you use the command in combination with a delta marker, that delta marker is turned into a normal marker.

**Suffix:**

<n>                      [Window](#)

<m>                      [Marker](#)

**Example:**

`CALC:MARK2:FUNC:REF`

Sets the reference level to the level of marker 2.

**Manual operation:** See "[Reference Level = Marker Level](#)" on page 479

---

#### **CALCulate<n>:UNIT:POWer <Unit>**

**UNIT<n>:POWer <Unit>**

This command selects the unit of the y-axis.

The unit applies to all power-based measurement windows with absolute values.

**Suffix:**

<n>                      irrelevant

## Setting Basic Spectrum RF Measurement Parameters

**Parameters:**

<Unit> DBM | V | A | W | DBPW | WATT | DBUV | DBMV | VOLT |  
 DBUA | AMPere  
 (Units based on 1 MHz require installed R&S FPL1-K54 (EMI  
 measurements) option.)  
 \*RST: dBm

**Example:**

UNIT:POW DBM  
 Sets the power unit to dBm.

**DISPlay[:WINDow<n>]:TRACe<t>:Y[:SCALe]:RLEVel <ReferenceLevel>**

This command defines the reference level (for all traces in all windows).

With a reference level offset ≠ 0, the value range of the reference level is modified by the offset.

**Suffix:**

<n> irrelevant  
 <t> irrelevant

**Parameters:**

<ReferenceLevel> The unit is variable.  
 Range: see datasheet  
 \*RST: 0 dBm  
 Default unit: DBM

**Example:**

DISP:TRAC:Y:RLEV -60dBm

**Manual operation:** See " [Reference Level](#) " on page 429

**DISPlay[:WINDow<n>]:TRACe<t>:Y[:SCALe]:RLEVel:OFFSet <Offset>**

This command defines a reference level offset (for all traces in all windows).

**Suffix:**

<n> irrelevant  
 <t> irrelevant

**Parameters:**

<Offset> Range: -200 dB to 200 dB  
 \*RST: 0dB  
 Default unit: DB

**Example:**

DISP:TRAC:Y:RLEV:OFFS -10dB

**Manual operation:** See "[Shifting the Display \( Offset \)](#)" on page 356

See "[Shifting the Display \( Offset \)](#)" on page 430

### 9.8.3.2 Configuring the Attenuation

|                                 |     |
|---------------------------------|-----|
| INPut<ip>:ATTenuation.....      | 731 |
| INPut<ip>:EATT:AUTO.....        | 731 |
| INPut<ip>:ATTenuation:AUTO..... | 731 |

---

#### INPut<ip>:ATTenuation <Attenuation>

This command defines the total attenuation for RF input.

If you set the attenuation manually, it is no longer coupled to the reference level, but the reference level is coupled to the attenuation. Thus, if the current reference level is not compatible with an attenuation that has been set manually, the command also adjusts the reference level.

#### Suffix:

<ip>                    1 | 2  
                              irrelevant

#### Parameters:

<Attenuation>        Range:        see data sheet  
                              Increment:  5 dB (with optional electr. attenuator: 1 dB)  
                              \*RST:        10 dB (AUTO is set to ON)  
                              Default unit: DB

#### Example:

INP:ATT 30dB  
Defines a 30 dB attenuation and decouples the attenuation from the reference level.

**Manual operation:** See "[Attenuation Mode / Value](#)" on page 431

---

#### INPut<ip>:EATT:AUTO <State>

#### INPut<ip>:ATTenuation:AUTO <State>

This command couples or decouples the attenuation to the reference level. Thus, when the reference level is changed, the R&S FPL1000 determines the signal level for optimal internal data processing and sets the required attenuation accordingly.

For the R&S FPL1000, these commands are identical.

#### Suffix:

<ip>                    1 | 2  
                              irrelevant

#### Parameters:

<State>                ON | OFF | 0 | 1  
                              \*RST:        1

#### Example:

INP:ATT:AUTO ON  
Couples the attenuation to the reference level.

**Manual operation:** See "[Attenuation Mode / Value](#)" on page 431

### 9.8.3.3 Configuring a Preamplicifier

INPut<ip>:GAIN:STATe.....732

---

**INPut<ip>:GAIN:STATe <State>**

This command turns the internal preamplifier on and off. It requires the optional preamplifier hardware.

If activated, the input signal is amplified by 20 dB.

**Suffix:**

<ip>                    1 | 2  
                          irrelevant

**Parameters:**

<State>                ON | OFF | 0 | 1  
                          **OFF | 0**  
                          Switches the function off  
                          **ON | 1**  
                          Switches the function on  
                          \*RST:        0

**Example:**

INP:GAIN:STAT ON  
Switches on 15 dB preamplification.  
Switches on 20 dB preamplification.

**Manual operation:** See " [Preamplifier](#) " on page 432

### 9.8.3.4 Scaling the Y-Axis

DISPlay[:WINDow<n>]:TRACe<t>:Y[:SCALe].....732

DISPlay[:WINDow<n>]:TRACe<t>:Y[:SCALe]:AUTO ONCE.....733

DISPlay[:WINDow<n>]:SUBWindow<w>:TRACe<t>:Y[:SCALe]:MODE.....733

DISPlay[:WINDow<n>]:TRACe<t>:Y[:SCALe]:RPOsition.....733

DISPlay[:WINDow<n>]:SUBWindow<w>:TRACe<t>:Y:SPACing.....734

---

**DISPlay[:WINDow<n>]:TRACe<t>:Y[:SCALe] <Range>**

This command defines the display range of the y-axis (for all traces).

Note that the command works only for a logarithmic scaling. You can select the scaling with `DISPlay[:WINDow<n>][:SUBWindow<w>]:TRACe<t>:Y:SPACing`.

**Suffix:**

<n>                    [Window](#)  
<t>                    irrelevant

**Parameters:**

<Range>                Range:        1 dB to 200 dB  
                          \*RST:        100 dB  
                          Default unit: HZ

**Example:** DISP:TRAC:Y 110dB

**Manual operation:** See " [Range](#) " on page 433

#### DISPlay[:WINDow<n>]:TRACe<t>:Y[:SCALe]:AUTO ONCE

Automatic scaling of the y-axis is performed once, then switched off again (for all traces).

**Suffix:**

<n> [Window](#)

<t> irrelevant

**Manual operation:** See " [Auto Scale Once](#) " on page 433

#### DISPlay[:WINDow<n>][:SUBWindow<w>]:TRACe<t>:Y[:SCALe]:MODE <arg0>

This command selects the type of scaling of the y-axis (for all traces).

When the display update during remote control is off, this command has no immediate effect.

**Suffix:**

<n> [Window](#)

<w> subwindow

<t> irrelevant

**Parameters:**

<arg0> **ABSolute**  
absolute scaling of the y-axis

**RELative**  
relative scaling of the y-axis

\*RST: ABSolute

**Example:** DISP:TRAC:Y:MODE REL

**Manual operation:** See " [Scaling](#) " on page 433

#### DISPlay[:WINDow<n>]:TRACe<t>:Y[:SCALe]:RPOSition <Position>

This command defines the vertical position of the reference level on the display grid (for all traces).

The R&S FPL1000 adjusts the scaling of the y-axis accordingly.

For measurements with the optional external generator control, the command defines the position of the reference value.

**Suffix:**

<n> [Window](#)

<t> irrelevant

**Parameters:**

<Position> 0 PCT corresponds to the lower display border, 100% corresponds to the upper display border.  
 \*RST: 100 PCT = frequency display; 50 PCT = time display  
 Default unit: PCT

**Example:**

DISP:TRAC:Y:RPOS 50PCT

**Manual operation:** See " [Ref Level Position](#) " on page 433

**DISPlay[:WINDow<n>][:SUBWindow<w>]:TRACe<t>:Y:SPACing <ScalingType>**

This command selects the scaling of the y-axis (for all traces, <t> is irrelevant).

**Suffix:**

<n> [Window](#)  
 <w> subwindow  
 <t> [Trace](#)

**Parameters:**

<ScalingType> **LOGarithmic**  
 Logarithmic scaling.  
**LINear**  
 Linear scaling in %.  
**LDB**  
 Linear scaling in the specified unit.  
**PERCent**  
 Linear scaling in %.  
 \*RST: LOGarithmic

**Example:**

DISP:TRAC:Y:SPAC LIN  
 Selects linear scaling in %.

**Manual operation:** See " [Scaling](#) " on page 433

### 9.8.4 Configuring Triggered and Gated Measurements

The commands required to configure a triggered or gated measurement in a remote environment are described here.

The tasks for manual operation are described in [Chapter 8.7, "Trigger and Gate Configuration"](#), on page 449.



\*OPC should be used after requesting data. This will hold off any subsequent changes to the selected trigger source, until after the sweep is completed and the data is returned.

- [Configuring the Triggering Conditions](#).....735
- [Configuring Gated Measurements](#).....739

#### 9.8.4.1 Configuring the Triggering Conditions

The following commands are required to configure a triggered measurement.

|                                                                                 |     |
|---------------------------------------------------------------------------------|-----|
| <a href="#">TRIGger[:SEQuence]:DTIME</a> .....                                  | 735 |
| <a href="#">TRIGger[:SEQuence]:HOLDoff[:TIME]</a> .....                         | 735 |
| <a href="#">TRIGger[:SEQuence]:IFPower:HOLDoff</a> .....                        | 736 |
| <a href="#">TRIGger[:SEQuence]:IFPower:HYSTeresis</a> .....                     | 736 |
| <a href="#">TRIGger&lt;tp&gt;[:SEQuence]:LEVel[:EXternal&lt;port&gt;]</a> ..... | 737 |
| <a href="#">TRIGger[:SEQuence]:LEVel:IFPower</a> .....                          | 737 |
| <a href="#">TRIGger[:SEQuence]:LEVel:IQPower</a> .....                          | 737 |
| <a href="#">TRIGger[:SEQuence]:SLOPe</a> .....                                  | 738 |
| <a href="#">TRIGger[:SEQuence]:SOURce</a> .....                                 | 738 |
| <a href="#">TRIGger[:SEQuence]:TIME:RINTerval</a> .....                         | 739 |

---

#### **TRIGger[:SEQuence]:DTIME** <DropoutTime>

Defines the time the input signal must stay below the trigger level before a trigger is detected again.

##### **Parameters:**

<DropoutTime>          Dropout time of the trigger.  
                                  Range:        0 s to 10.0 s  
                                  \*RST:        0 s  
                                  Default unit: S

**Manual operation:**    See " [Drop-Out Time](#) " on page 456

---

#### **TRIGger[:SEQuence]:HOLDoff[:TIME]** <Offset>

Defines the time offset between the trigger event and the start of the sweep.

A negative offset is possible for time domain measurements.

For the trigger sources "External" or "IF Power", a common input signal is used for both trigger and gate. Therefore, changes to the gate delay will affect the trigger offset as well.

**Parameters:**

<Offset> For measurements in the frequency domain, the range is 0 s to 30 s.  
 For measurements in the time domain, the range is the negative sweep time to 30 s.  
 \*RST: 0 s  
 Default unit: S

**Example:** TRIG:HOLD 500us

**Manual operation:** See " [Trigger Offset](#) " on page 456

**TRIGger[:SEQuence]:IFPower:HOLDoff <Period>**

This command defines the holding time before the next trigger event.

Note that this command can be used for **any trigger source**, not just IF Power (despite the legacy keyword).

**Note:** If you perform gated measurements in combination with the IF Power trigger, the R&S FPL1000 ignores the holding time for frequency sweep, FFT sweep, zero span and I/Q data measurements.

**Parameters:**

<Period> Range: 0 s to 10 s  
 \*RST: 0 s  
 Default unit: S

**Example:** TRIG:SOUR EXT  
 Sets an external trigger source.  
 TRIG:IFP:HOLD 200 ns  
 Sets the holding time to 200 ns.

**Manual operation:** See " [Trigger Holdoff](#) " on page 457

**TRIGger[:SEQuence]:IFPower:HYSteresis <Hysteresis>**

This command defines the trigger hysteresis, which is only available for "IF Power" trigger sources.

**Parameters:**

<Hysteresis> Range: 3 dB to 50 dB  
 \*RST: 3 dB  
 Default unit: DB

**Example:** TRIG:SOUR IFP  
 Sets the IF power trigger source.  
 TRIG:IFP:HYST 10DB  
 Sets the hysteresis limit value.

**Manual operation:** See " [Hysteresis](#) " on page 456



---

**TRIGger<tp>[:SEQuence]:LEVel[:EXTeRnal<port>] <TriggerLevel>**

This command defines the level the external signal must exceed to cause a trigger event.

**Suffix:**

<tp> irrelevant

<port> Selects the trigger port.  
1 = trigger port 1 (TRIG IN connector on rear panel)  
2 = trigger port 2 (TRIG AUX connector on rear panel)

**Parameters:**

<TriggerLevel> For the R&S FPL1000, the external trigger level is always 1.4 V. It cannot be changed.

\*RST: 1.4 V

**Manual operation:** See " [Trigger Level](#) " on page 455

---

**TRIGger[:SEQuence]:LEVel:IFPower <TriggerLevel>**

This command defines the power level at the third intermediate frequency that must be exceeded to cause a trigger event.

Note that any RF attenuation or preamplification is considered when the trigger level is analyzed. If defined, a reference level offset is also considered.

**Parameters:**

<TriggerLevel> For details on available trigger levels and trigger bandwidths see the data sheet.

\*RST: -10 dBm  
Default unit: DBM

**Example:** TRIG:LEV:IFP -30DBM

**Manual operation:** See " [Trigger Level](#) " on page 455

---

**TRIGger[:SEQuence]:LEVel:IQPower <TriggerLevel>**

This command defines the magnitude the I/Q data must exceed to cause a trigger event.

Note that any RF attenuation or preamplification is considered when the trigger level is analyzed. If defined, a reference level offset is also considered.

**Parameters:**

<TriggerLevel> Range: -130 dBm to 30 dBm  
\*RST: -20 dBm  
Default unit: DBM

**Example:** TRIG:LEV:IQP -30DBM

**Manual operation:** See " [Trigger Level](#) " on page 455

**TRIGger[:SEQuence]:SLOPe** <Type>

For all trigger sources except time you can define whether triggering occurs when the signal rises to the trigger level or falls down to it.

**Parameters:**

<Type> POSitive | NEGative

**POSitive**

Triggers when the signal rises to the trigger level (rising edge).

**NEGative**

Triggers when the signal drops to the trigger level (falling edge).

\*RST: POSitive

**Example:** TRIG:SLOP NEG

**Manual operation:** See " [Slope](#) " on page 457

**TRIGger[:SEQuence]:SOURce** <Source>

This command selects the trigger source.

For details on trigger sources see " [Trigger Source](#) " on page 454.

**Note on external triggers:**

If a measurement is configured to wait for an external trigger signal in a remote control program, remote control is blocked until the trigger is received and the program can continue. Make sure this situation is avoided in your remote control programs.

For troubleshooting tips see " [Incompleted sequential commands - blocked remote channels](#) " on page 965.

**Parameters:**

<Source> **IMMediate**

Free Run

**EXTernal**

Trigger signal from the "Trigger Input" connector.

Trigger signal from the "Trigger In" connector.

**IFPower**

Second intermediate frequency

**TIME**

Time interval

**VIDeo**

Video mode is available in the time domain and only in the Spectrum application.

\*RST: IMMediate

**Example:** TRIG:SOUR EXT

Selects the external trigger input as source of the trigger signal

**Manual operation:** See " [Trigger Source](#) " on page 454  
 See " [Free Run](#) " on page 454  
 See " [External Trigger 1](#) " on page 455  
 See " [Video](#) " on page 455  
 See " [IF Power](#) " on page 455  
 See " [Time](#) " on page 455

---

#### TRIGger[:SEquence]:TIME:RINTerval <Interval>

This command defines the repetition interval for the time trigger.

##### Parameters:

<Interval>                    2.0 ms to 5000  
 Range:                    2 ms to 5000 s  
 \*RST:                    1.0 s  
 Default unit: S

##### Example:

```
TRIG:SOUR TIME
Selects the time trigger input for triggering.
TRIG:TIME:RINT 50
The sweep starts every 50 s.
```

**Manual operation:** See " [Repetition Interval](#) " on page 456

### 9.8.4.2 Configuring Gated Measurements

|                                   |     |
|-----------------------------------|-----|
| [SENSe:]SWEep:EGATe.....          | 739 |
| [SENSe:]SWEep:EGATe:HOLDoff.....  | 740 |
| [SENSe:]SWEep:EGATe:LENGth.....   | 740 |
| [SENSe:]SWEep:EGATe:POLarity..... | 740 |
| [SENSe:]SWEep:EGATe:SOURce.....   | 741 |
| [SENSe:]SWEep:EGATe:TYPE.....     | 741 |

---

#### [SENSe:]SWEep:EGATe <State>

This command turns gated measurements on and off.

The measurement ends when a particular number of measurement points has been recorded.

(See [SENSe:]SWEep[:WINDow<n>]:POINts on page 727).

Performing gated measurements turns the squelch off.

##### Parameters:

<State>                    ON | OFF | 0 | 1  
                               **OFF | 0**  
                               Switches the function off  
                               **ON | 1**  
                               Switches the function on

**Example:**

```
SWE:EGAT ON
Switches on the gate mode.
SWE:EGAT:TYPE EDGE
Switches on the edge-triggered mode.
SWE:EGAT:HOLD 100US
Sets the gate delay to 100 µs.
SWE:EGAT:LEN 500US
Sets the gate opening time to 500 µs.
INIT;*WAI
Starts a sweep and waits for its end.
```

**Manual operation:** See " [Gated Trigger](#) " on page 459

---

**[SENSe:]SWEep:EGATe:HOLDoff** <DelayTime>

This command defines the delay time between the gate signal and the continuation of the measurement.

**Note:** If you perform gated measurements in combination with the IF Power trigger, the R&S FPL1000 ignores the holding time for frequency sweep, FFT sweep, zero span and I/Q mode measurements.

**Parameters:**

<DelayTime>            Range:     0 s to 30 s  
                           \*RST:     0 s  
                           Default unit: S

**Example:**            SWE:EGAT:HOLD 100us

**Manual operation:** See " [Gate Delay](#) " on page 460

---

**[SENSe:]SWEep:EGATe:LENGth** <GateLength>

This command defines the gate length.

**Parameters:**

<GateLength>           Range:     125 ns to 30 s  
                           \*RST:     400µs  
                           Default unit: S

**Example:**            SWE:EGAT:LENG 10ms

**Manual operation:** See " [Gate Length](#) " on page 460

---

**[SENSe:]SWEep:EGATe:POLarity** <Polarity>

This command selects the polarity of an external gate signal.

The setting applies both to the edge of an edge-triggered signal and the level of a level-triggered signal.

**Parameters:**

<Polarity>              POSitive | NEGative  
                           \*RST:     POSitive

**Example:** `SWE:EGAT:POL POS`

**Manual operation:** See " [Slope](#) " on page 457

---

**[SENSe:]SWEep:EGATe:SOURce <Source>**

This command selects the signal source for gated measurements.

If an IF power signal is used, the gate is opened as soon as a signal at > -20 dBm is detected within the IF path bandwidth (10 MHz).

For more information see " [Trigger Source](#) " on page 454.

**Parameters:**

<Source>            EXTernal | IFPower | TIME  
 \*RST:            IFPower

**Example:** `SWE:EGAT:SOUR IFP`  
 Switches the gate source to IF power.

**Manual operation:** See " [Trigger Source](#) " on page 454  
 See " [External Trigger 1](#) " on page 455  
 See " [IF Power](#) " on page 455

---

**[SENSe:]SWEep:EGATe:TYPE <Type>**

This command selects the way gated measurements are triggered.

**Parameters:**

<Type>            **LEVEL**  
 The trigger event for the gate to open is a particular power level. After the gate signal has been detected, the gate remains open until the signal disappears.  
**Note:** If you perform gated measurements in combination with the IF Power trigger, the R&S FPL1000 ignores the holding time for frequency sweep, FFT sweep, zero span and I/Q mode measurements.

**EDGE**  
 The trigger event for the gate to open is the detection of the signal edge. After the gate signal has been detected, the gate remains open until the gate length is over.  
 \*RST:            EDGE

**Example:** `SWE:EGAT:TYPE EDGE`

**Manual operation:** See " [Gate Mode](#) " on page 459

## 9.8.5 Configuring the Data Input and Output

The following commands are required to configure data input and output.

- [RF Input](#)..... 742
- [Working with Power Sensors](#)..... 744
- [Configuring the Outputs](#)..... 752

### 9.8.5.1 RF Input

|                                                                    |     |
|--------------------------------------------------------------------|-----|
| <a href="#">INPut&lt;ip&gt;:ATTenuation:PROTection:RESet</a> ..... | 742 |
| <a href="#">INPut&lt;ip&gt;:FILTer:SAW</a> .....                   | 742 |
| <a href="#">INPut&lt;ip&gt;:IMPedance</a> .....                    | 743 |
| <a href="#">INPut&lt;ip&gt;:SElect</a> .....                       | 743 |
| <a href="#">INPut&lt;ip&gt;:UPORt:STATe</a> .....                  | 743 |
| <a href="#">INPut&lt;ip&gt;:UPORt[:VALue]</a> .....                | 744 |

---

#### INPut<ip>:ATTenuation:PROTection:RESet

This command resets the attenuator and reconnects the RF input with the input mixer for the R&S FPL1000 after an overload condition occurred and the protection mechanism intervened. The error status bit (bit 3 in the `STAT:QUES:POW` status register) and the `INPUT OVLD` message in the status bar are cleared.

(See [STATus:QUESTionable:POWer\[:EVENT\]?](#) on page 949 and ["STATus:QUESTionable:POWer Register"](#) on page 199).

The command works only if the overload condition has been eliminated first.

For details on the protection mechanism see ["RF Input Protection"](#) on page 410.

#### Suffix:

<ip>                    1 | 2  
                          irrelevant

**Example:**            INP:ATT:PROT:RES

---

#### INPut<ip>:FILTer:SAW <State>

Determines which IF path the R&S FPL1000 hardware uses.

#### Suffix:

<ip>                    1 | 2  
                          irrelevant

#### Parameters:

<State>                AUTO | OFF

##### AUTO

The R&S FPL1000 determines which IF path to use automatically, depending on the used analysis bandwidth.

##### OFF

The wide IF path is always used.

\*RST:                I/Q Analyzer: AUTO; VSA: OFF

**Example:**            INP:FILT:SAW AUTO

**Manual operation:** See ["SAW filter"](#) on page 410

**INPut<ip>:IMPedance <Impedance>**

This command selects the nominal input impedance of the RF input. In some applications, only 50 Ω are supported.

**Suffix:**

<ip> 1 | 2  
irrelevant

**Parameters:**

<Impedance> 50 | 75  
**numeric value**  
User-defined impedance from 50 Ohm to 100000000 Ohm (=100 MOhm)  
User-defined values are only available for the Spectrum application, the I/Q Analyzer, and some optional applications.  
\*RST: 50 Ω  
Default unit: OHM

**Example:** INP:IMP 75

**Manual operation:** See " [Impedance](#) " on page 410  
See " [Unit](#) " on page 430

**INPut<ip>:SELEct <Source>**

This command selects the signal source for measurements, i.e. it defines which connector is used to input data to the R&S FPL1000.

If no additional input options are installed, only RF input is supported.

**Suffix:**

<ip> 1..n

**Parameters:**

<Source> **RF**  
Radio Frequency ("RF INPUT" connector)  
\*RST: RF

**Manual operation:** See " [Radio Frequency State](#) " on page 410

**INPut<ip>:UPORt:STATe <State>**

This command toggles the control lines of the user ports for the **AUX PORT** connector. This 9-pole SUB-D male connector is located on the rear panel of the R&S FPL1000.

See the R&S FPL1000 Getting Started manual for details.

**Suffix:**

<ip> 1 | 2  
irrelevant

**Parameters:**

<State> **ON | 1**  
User port is switched to INPut

**OFF | 0**

User port is switched to OUTPut

\*RST: 1

**INPut<ip>:UPORt[:VALue]**

This command queries the control lines of the user ports.

For details see [OUTPut<up>:UPORt\[:VALue\]](#) on page 754.**Suffix:**

<ip> 1 | 2  
irrelevant

**Return values:**

<Level> bit values in hexadecimal format  
TTL type voltage levels (max. 5V)  
Range: #B00000000 to #B00111111

**Example:**

```
INP:UPOR?
//Result: #B00100100
Pins 5 and 7 are active.
```

**9.8.5.2 Working with Power Sensors**

The following commands describe how to work with power sensors.

These commands require the use of a Rohde &amp; Schwarz power sensor. For a list of supported sensors, see the data sheet.



The [Sensor] connector is provided by the "Additional Interfaces" option R&S FPL1-B5. Additionally, the power sensor measurement requires the option R&S FPL1-K9.

- [Configuring Power Sensors](#)..... 744
- [Configuring Power Sensor Measurements](#)..... 746

**Configuring Power Sensors**

[SYSTem:COMMunicate:RDEvice:PMETer<p>:CONFigure:AUTO\[:STATe\]](#)..... 744  
[SYSTem:COMMunicate:RDEvice:PMETer<p>:COUNT?](#)..... 745  
[SYSTem:COMMunicate:RDEvice:PMETer<p>:DEFine](#)..... 745

**SYSTem:COMMunicate:RDEvice:PMETer<p>:CONFigure:AUTO[:STATe] <State>**

This command turns automatic assignment of a power sensor to the power sensor index on and off.

**Suffix:**

<p> Power sensor index



**Parameters:**

<State> ON | OFF | 0 | 1  
 \*RST: 1

**Example:**

SYST:COMM:RDEV:PMET:CONF:AUTO OFF

**Manual operation:** See " [Select](#) " on page 413

**SYSTem:COMMunicate:RDEvice:PMETer<p>:COUNT?**

This command queries the number of power sensors currently connected to the R&S FPL1000.

**Suffix:**

<p> Power sensor index

**Return values:**

<NumberSensors> Number of connected power sensors.

**Example:**

SYST:COMM:RDEV:PMET:COUN?

**Usage:**

Query only

**Manual operation:** See " [Select](#) " on page 413

**SYSTem:COMMunicate:RDEvice:PMETer<p>:DEFine <Placeholder>, <Type>, <Interface>, <SerialNo>**

This command assigns the power sensor with the specified serial number to the selected power sensor index (configuration).

The query returns the power sensor type and serial number of the sensor assigned to the specified index.

**Suffix:**

<p> Power sensor index

**Parameters:**

<Placeholder> Currently not used

<Type> Detected power sensor type, e.g. "NRP-Z81".

<Interface> Interface the power sensor is connected to; always "USB"

<SerialNo> Serial number of the power sensor assigned to the specified index

## Setting Basic Spectrum RF Measurement Parameters

**Example:** `SYST:COMM:RDEV:PMET2:DEF '', 'NRP-Z81', '', '123456'`  
 Assigns the power sensor with the serial number '123456' to the configuration "Power Sensor 2".  
`SYST:COMM:RDEV:PMET2:DEF?`  
 Queries the sensor assigned to "Power Sensor 2".  
**Result:**  
`'', 'NRP-Z81', 'USB', '123456'`  
 The NRP-Z81 power sensor with the serial number '123456' is assigned to the "Power Sensor 2".

**Manual operation:** See " [Select](#) " on page 413

**Configuring Power Sensor Measurements**

|                                                                                        |     |
|----------------------------------------------------------------------------------------|-----|
| <a href="#">CALibration:PMETer&lt;p&gt;:ZERO:AUTO ONCE</a> .....                       | 746 |
| <a href="#">CALCulate&lt;n&gt;:PMETer&lt;p&gt;:RELative[MAGNitude]</a> .....           | 747 |
| <a href="#">CALCulate&lt;n&gt;:PMETer&lt;p&gt;:RELative[MAGNitude]:AUTO ONCE</a> ..... | 747 |
| <a href="#">CALCulate&lt;n&gt;:PMETer&lt;p&gt;:RELative:STATe</a> .....                | 747 |
| <a href="#">FETCh:PMETer&lt;p&gt;?</a> .....                                           | 748 |
| <a href="#">READ:PMETer&lt;p&gt;?</a> .....                                            | 748 |
| <a href="#">[SENSe:]PMETer&lt;p&gt;:DCYCLE[:STATe]</a> .....                           | 748 |
| <a href="#">[SENSe:]PMETer&lt;p&gt;:DCYCLE:VALue</a> .....                             | 748 |
| <a href="#">[SENSe:]PMETer&lt;p&gt;:FREQuency</a> .....                                | 749 |
| <a href="#">[SENSe:]PMETer&lt;p&gt;:FREQuency:LINK</a> .....                           | 749 |
| <a href="#">[SENSe:]PMETer&lt;p&gt;:MTIME</a> .....                                    | 749 |
| <a href="#">[SENSe:]PMETer&lt;p&gt;:MTIME:AVERAge:COUNT</a> .....                      | 750 |
| <a href="#">[SENSe:]PMETer&lt;p&gt;:MTIME:AVERAge[:STATe]</a> .....                    | 750 |
| <a href="#">[SENSe:]PMETer&lt;p&gt;:ROFFset[:STATe]</a> .....                          | 751 |
| <a href="#">[SENSe:]PMETer&lt;p&gt;[:STATe]</a> .....                                  | 751 |
| <a href="#">[SENSe:]PMETer&lt;p&gt;:UPDate[:STATe]</a> .....                           | 751 |
| <a href="#">UNIT&lt;n&gt;:PMETer&lt;p&gt;:POWer</a> .....                              | 752 |
| <a href="#">UNIT&lt;n&gt;:PMETer&lt;p&gt;:POWer:RATio</a> .....                        | 752 |

**CALibration:PMETer<p>:ZERO:AUTO ONCE**

This command zeroes the power sensor.

Note that you have to disconnect the signals from the power sensor input before you start to zero the power sensor. Otherwise, results are invalid.

**Suffix:**

<p> Power sensor index

**Example:**

`CAL:PMET2:ZERO:AUTO ONCE; *WAI`

Starts zeroing the power sensor 2 and delays the execution of further commands until zeroing is concluded.

**Usage:**

Event

**Manual operation:** See " [Zeroing Power Sensor](#) " on page 413

**CALCulate<n>:PMETer<p>:RELative[:MAGNitude] <RefValue>**

This command defines the reference value for relative measurements.

**Suffix:**

<n> [Window](#)

<p> Power sensor index

**Parameters:**

<RefValue> Range: -200 dBm to 200 dBm  
\*RST: 0  
Default unit: DBM

**Example:**

`CALC:PMET2:REL -30`

Sets the reference value for relative measurements to -30 dBm for power sensor 2.

**Manual operation:** See "[Reference Value](#)" on page 414

**CALCulate<n>:PMETer<p>:RELative[:MAGNitude]:AUTO ONCE**

This command sets the current measurement result as the reference level for relative measurements.

**Suffix:**

<n> [Window](#)

<p> Power sensor index

**Example:**

`CALC:PMET2:REL:AUTO ONCE`

Takes the current measurement value as reference value for relative measurements for power sensor 2.

**Usage:**

Event

**Manual operation:** See "[Setting the Reference Level from the Measurement Measurement Reference](#)" on page 414

**CALCulate<n>:PMETer<p>:RELative:STATe <State>**

This command turns relative power sensor measurements on and off.

**Suffix:**

<n> [Window](#)

<p> Power sensor index

**Parameters:**

<State> ON | OFF | 0 | 1  
**OFF | 0**  
Switches the function off  
**ON | 1**  
Switches the function on

**Example:** `CALC:PMET2:REL:STAT ON`  
 Activates the relative display of the measured value for power sensor 2.

---

#### FETCh:PMETer<p>?

This command queries the results of power sensor measurements.

**Suffix:**  
 <p> Power sensor index

**Usage:** Query only

---

#### READ:PMETer<p>?

This command initiates a power sensor measurement and queries the results.

**Suffix:**  
 <p> Power sensor index

**Usage:** Query only

---

#### [SENSe:]PMETer<p>:DCYCLe[:STATe] <State>

This command turns the duty cycle correction on and off.

**Suffix:**  
 <p> Power sensor index

**Parameters:**  
 <State> ON | OFF | 0 | 1  
**OFF | 0**  
 Switches the function off  
**ON | 1**  
 Switches the function on

**Example:** `PMET2:DCYC:STAT ON`

**Manual operation:** See " [Duty Cycle](#) " on page 415

---

#### [SENSe:]PMETer<p>:DCYCLe:VALue <Percentage>

This command defines the duty cycle for the correction of pulse signals.

The power sensor uses the duty cycle in combination with the mean power to calculate the power of the pulse.

**Suffix:**  
 <p> Power sensor

**Parameters:**  
 <Percentage> Range: 0.001 to 99.999  
 \*RST: 99.999  
 Default unit: %

**Example:** `PMET2:DCYC:STAT ON`  
 Activates the duty cycle correction.  
`PMET2:DCYC:VAL 0.5`  
 Sets the correction value to 0.5%.

**Manual operation:** See "[Duty Cycle](#)" on page 415

**[SENSe:]PMETer<p>:FREQuency <Frequency>**

This command defines the frequency of the power sensor.

**Suffix:**  
 <p> Power sensor index

**Parameters:**  
 <Frequency> The available value range is specified in the data sheet of the power sensor in use.

\*RST: 50 MHz  
 Default unit: HZ

**Example:** `PMET2:FREQ 1GHZ`  
 Sets the frequency of the power sensor to 1 GHz.

**Manual operation:** See "[Frequency Manual](#)" on page 413

**[SENSe:]PMETer<p>:FREQuency:LINK <Coupling>**

This command selects the frequency coupling for power sensor measurements.

**Suffix:**  
 <p> Power sensor index

**Parameters:**  
 <Coupling> **CENTer**  
 Couples the frequency to the center frequency of the analyzer

**MARKer1**  
 Couples the frequency to the position of marker 1

**OFF**  
 Switches the frequency coupling off

\*RST: CENTer

**Example:** `PMET2:FREQ:LINK CENT`  
 Couples the frequency to the center frequency of the analyzer

**Manual operation:** See "[Frequency Coupling](#)" on page 413

**[SENSe:]PMETer<p>:MTIME <Duration>**

This command selects the duration of power sensor measurements.

**Suffix:**  
 <p> Power sensor index

## Setting Basic Spectrum RF Measurement Parameters

**Parameters:**

<Duration>           SHORT | NORMAl | LONG  
 \*RST:                NORMAl

**Example:**

PMET2:MTIM:SHOR  
 Sets a short measurement duration for measurements of stationary high power signals for the selected power sensor.

**Manual operation:** See "[Meas Time/Average](#)" on page 414

**[SENSe:]PMETer<p>:MTIME:AVERAge:COUNT <NumberReadings>**

This command sets the number of power readings included in the averaging process of power sensor measurements.

Extended averaging yields more stable results for power sensor measurements, especially for measurements on signals with a low power, because it minimizes the effects of noise.

**Suffix:**

<p>                   Power sensor index

**Parameters:**

<NumberReadings> An average count of 0 or 1 performs one power reading.  
 Range:            0 to 256  
 Increment:       binary steps (1, 2, 4, 8, ...)

**Example:**

PMET2:MTIM:AVER ON  
 Activates manual averaging.  
 PMET2:MTIM:AVER:COUN 8  
 Sets the number of readings to 8.

**Manual operation:** See "[Average Count \( Number of Readings \)](#)" on page 415

**[SENSe:]PMETer<p>:MTIME:AVERAge[:STATe] <State>**

This command turns averaging for power sensor measurements on and off.

**Suffix:**

<p>                   Power sensor index

**Parameters:**

<State>               ON | OFF | 0 | 1  
**OFF | 0**  
 Switches the function off  
**ON | 1**  
 Switches the function on

**Example:**

PMET2:MTIM:AVER ON  
 Activates manual averaging.

**Manual operation:** See "[Meas Time/Average](#)" on page 414

---

**[SENSe:]PMETer<p>:ROFFset[:STATe] <State>**

This command includes or excludes the reference level offset of the analyzer for power sensor measurements.

**Suffix:**

<p> Power sensor index

**Parameters:**

<State> ON | OFF | 0 | 1  
**OFF | 0**  
 Switches the function off  
**ON | 1**  
 Switches the function on

**Example:**

PMET2:ROFF OFF

Takes no offset into account for the measured power.

**Manual operation:** See " [Use Ref Level Offset](#) " on page 414

---

**[SENSe:]PMETer<p>[:STATe] <State>**

This command turns a power sensor on and off.

**Suffix:**

<p> Power sensor index

**Parameters:**

<State> ON | OFF | 0 | 1  
**OFF | 0**  
 Switches the function off  
**ON | 1**  
 Switches the function on

**Example:**

PMET1 ON

Switches the power sensor measurements on.

**Manual operation:** See " [State](#) " on page 412  
 See " [Select](#) " on page 413

---

**[SENSe:]PMETer<p>:UPDate[:STATe] <State>**

This command turns continuous update of power sensor measurements on and off.

If on, the results are update even if a single sweep is complete.

**Suffix:**

<p> Power sensor index

**Parameters:**

<State> ON | OFF | 0 | 1  
**OFF | 0**  
 Switches the function off

**ON | 1**

Switches the function on

**Example:** `PMET1:UPD ON`  
The data from power sensor 1 is updated continuously.

**Manual operation:** See " [Continuous Value Update](#) " on page 413

**UNIT<n>:PMETer<p>:POWer <Unit>**

This command selects the unit for absolute power sensor measurements.

**Suffix:**

<n> irrelevant  
<p> Power sensor index

**Parameters:**

<Unit> DBM | WATT | W  
\*RST: DBM

**Example:** `UNIT:PMET:POW DBM`

**Manual operation:** See " [Unit/Scale](#) " on page 414

**UNIT<n>:PMETer<p>:POWer:RATio <Unit>**

This command selects the unit for relative power sensor measurements.

**Suffix:**

<n> irrelevant  
<p> Power sensor index

**Parameters:**

<Unit> DB | PCT  
\*RST: DB

**Example:** `UNIT:PMET:POW:RAT DB`

**Manual operation:** See " [Unit/Scale](#) " on page 414

**9.8.5.3 Configuring the Outputs**

The following commands are required to provide output from the R&amp;S FPL1000.

Output functions require the option R&amp;S FPL1-B5 to be installed on the R&amp;S FPL1000.

|                                                       |     |
|-------------------------------------------------------|-----|
| <a href="#">DIAGnostic:SERVice:NSOource</a> .....     | 753 |
| <a href="#">OUTPut&lt;up&gt;:IF[:SOURce]</a> .....    | 753 |
| <a href="#">OUTPut&lt;up&gt;:IF:IFFRequency</a> ..... | 753 |
| <a href="#">OUTPut&lt;up&gt;:UPORt:STATe</a> .....    | 754 |
| <a href="#">OUTPut&lt;up&gt;:UPORt[:VALue]</a> .....  | 754 |
| <a href="#">OUTPut:UPORt:WTRigger:POLarity</a> .....  | 755 |
| <a href="#">SYSTem:SPEaker[:STATe]</a> .....          | 755 |
| <a href="#">SYSTem:SPEaker:VOLume</a> .....           | 755 |



**DIAGnostic:SERVice:NSource** <State>

This command turns the 28 V supply of the BNC connector labeled [noise source control] on the R&S FPL1000 on and off.

**Parameters:**

<State>            ON | OFF | 0 | 1  
**OFF | 0**  
 Switches the function off  
**ON | 1**  
 Switches the function on

**Example:**            DIAG:SERV:NSO ON

**Manual operation:** See "[Noise Source Control](#)" on page 418

**OUTPut<up>:IF[:SOURce]** <Source>

Defines the type of signal available at one of the output connectors of the R&S FPL1000.

**Suffix:**

<up>

**Parameters:**

<Source>            **IF**  
 The measured IF value is available at the IF/VIDEO output connector.  
 This connector is only available if the R&S FPL1-B5 option is installed.  
 The frequency at which the IF value is provided is defined using the [OUTPut<up>:IF:IFFrequency](#) command.

**VIDeo**  
 The displayed video signal (i.e. the filtered and detected IF signal, 200mV) is available at the IF/VIDEO output connector.  
 This setting is required to provide demodulated audio frequencies at the output.

\*RST:            IF

**Example:**            OUTP:IF VID  
 Selects the video signal for the IF/VIDEO output connector.

**Manual operation:** See "[Data Output](#)" on page 417

**OUTPut<up>:IF:IFFrequency** <Frequency>

This command defines the frequency for the IF output of the R&S FPL1000. The IF frequency of the signal is converted accordingly.

This command is available in the time domain and if the IF/VIDEO output is configured for IF.

**Suffix:**

&lt;up&gt;

**Parameters:**

<Frequency> \*RST: 50.0 MHz  
 Default unit: HZ

**Manual operation:** See "Data Output" on page 417

**OUTPut<up>:UPORt:STATe <State>**

This command toggles the control lines of the user ports for the **AUX PORT** connector. This 9-pole SUB-D male connector is located on the rear panel of the R&S FPL1000.

**Suffix:**

&lt;up&gt; irrelevant

**Parameters:**

<State> ON | OFF | 0 | 1  
**OFF | 0**  
 User port is switched to INPut  
**ON | 1**  
 User port is switched to OUTPut

**Example:** OUTP:UPOR:STAT ON

**OUTPut<up>:UPORt[:VALue] <Value>**

This command sets the control lines of the user ports.

The assignment of the pin numbers to the bits is as follows:

| Bit | 7   | 6   | 5 | 4 | 3 | 2 | 1 | 0 |
|-----|-----|-----|---|---|---|---|---|---|
| Pin | N/A | N/A | 5 | 3 | 4 | 7 | 6 | 2 |

Bits 7 and 6 are not assigned to pins and must always be 0.

The user port is written to with the given binary pattern.

If the user port is programmed to input instead of output (see [INPut<ip>:UPORt:STATe](#) on page 743), the output value is temporarily stored.

**Suffix:**

&lt;up&gt; irrelevant

**Parameters:**

<Value> bit values in hexadecimal format  
 TTL type voltage levels (max. 5V)  
 Range: #B00000000 to #B00111111

**Example:** OUTP:UPOR #B00100100  
 Sets pins 5 and 7 to 5 V.

**OUTPut:UPORt:WTRigger:POLarity** <State>

Defines the signal polarity that indicates the trigger availability at the optional [AUX PORT] connector of the R&S FPL1000.

**Parameters:**

&lt;State&gt;

HIGH | LOW

**LOW**

A low signal (= 0 V) indicates the instrument is ready to receive a trigger.

**HIGH**

A high signal (= 5 V) indicates the instrument is ready to receive a trigger.

**Example:**

OUTP:UPOR:WTR:POL HIGH

The R&S FPL1000 waits for a 5-V-signal at the AUX PORT connector before accepting a trigger signal.

**SYSTem:SPEaker[:STATe]** <State>

This command switches the built-in loudspeaker on or off for demodulated signals. This setting applies only to the current application.

The command is available in the time domain in Spectrum mode and in Analog Demodulation mode.

To set the volume, use the `SYSTem:SPEaker:VOLume` command.

**Parameters:**

&lt;State&gt;

ON | OFF | 0 | 1

**OFF | 0**

Switches the function off

**ON | 1**

Switches the function on

**Example:**

SYST:SPE ON

SYST:SPE:VOL 0.5

Sets the loudspeaker to half the full volume.

**Manual operation:**

See "[Data Output](#)" on page 417

See "[Loudspeaker](#)" on page 495

**SYSTem:SPEaker:VOLume** <Volume>

This command defines the volume of the built-in loudspeaker for demodulated signals. This setting is maintained for all applications.

The command is available in the time domain in Spectrum mode and in Analog Demodulation mode.

Note that you must switch the loudspeaker on first, using the `SYSTem:SPEaker[:STATe]` command.

**Parameters:**

<Volume> Percentage of the maximum possible volume.

Range: 0 to 1

\*RST: 0.5

**Example:**

SYST:SPE:VOL 0

Switches the loudspeaker to mute.

**Manual operation:**

See "Data Output" on page 417

See "Audio Output Volume" on page 495

## 9.8.6 Zooming into the Display

### 9.8.6.1 Using the Single Zoom

DISPlay[:WINDow<n>][:SUBWindow<w>]:ZOOM:AREA..... 756

DISPlay[:WINDow<n>][:SUBWindow<w>]:ZOOM[:STATE]..... 757

**DISPlay[:WINDow<n>][:SUBWindow<w>]:ZOOM:AREA <x1>,<y1>,<x2>,<y2>**

This command defines the zoom area.

To define a zoom area, you first have to turn the zoom on.

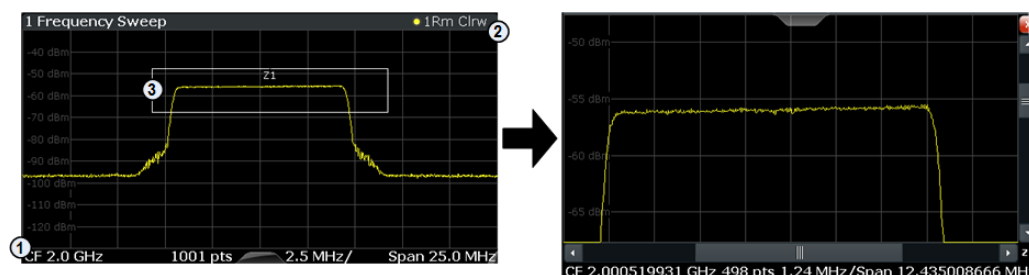

1 = origin of coordinate system (x1 = 0, y1 = 0)

2 = end point of system (x2 = 100, y2 = 100)

3 = zoom area (e.g. x1 = 60, y1 = 30, x2 = 80, y2 = 75)

**Suffix:**

<n> Window

<w> subwindow

**Parameters:**

<x1> Diagram coordinates in % of the complete diagram that define the zoom area.

The lower left corner is the origin of coordinate system. The upper right corner is the end point of the system.

Range: 0 to 100

Default unit: PCT

|                         |                                                                                                                                                                                                                                         |
|-------------------------|-----------------------------------------------------------------------------------------------------------------------------------------------------------------------------------------------------------------------------------------|
| <code>&lt;y1&gt;</code> | Diagram coordinates in % of the complete diagram that define the zoom area.<br>The lower left corner is the origin of coordinate system. The upper right corner is the end point of the system.<br>Range: 0 to 100<br>Default unit: PCT |
| <code>&lt;x2&gt;</code> | Diagram coordinates in % of the complete diagram that define the zoom area.<br>The lower left corner is the origin of coordinate system. The upper right corner is the end point of the system.<br>Range: 0 to 100<br>Default unit: PCT |
| <code>&lt;y2&gt;</code> | Diagram coordinates in % of the complete diagram that define the zoom area.<br>The lower left corner is the origin of coordinate system. The upper right corner is the end point of the system.<br>Range: 0 to 100<br>Default unit: PCT |

**Manual operation:** See " [Single Zoom](#) " on page 556

---

#### **DISPlay[:WINDow<n>][:SUBWindow<w>]:ZOOM[:STATe] <State>**

This command turns the zoom on and off.

**Suffix:**

|                        |                        |
|------------------------|------------------------|
| <code>&lt;n&gt;</code> | <a href="#">Window</a> |
| <code>&lt;w&gt;</code> | subwindow              |

**Parameters:**

|                            |                                                                                                              |
|----------------------------|--------------------------------------------------------------------------------------------------------------|
| <code>&lt;State&gt;</code> | ON   OFF   0   1<br><b>OFF   0</b><br>Switches the function off<br><b>ON   1</b><br>Switches the function on |
|----------------------------|--------------------------------------------------------------------------------------------------------------|

**Example:**

DISP:ZOOM ON  
Activates the zoom mode.

**Manual operation:** See " [Single Zoom](#) " on page 556  
See " [Restore Original Display](#) " on page 557

### 9.8.6.2 Using the Multiple Zoom

|                                                                   |     |
|-------------------------------------------------------------------|-----|
| DISPlay[:WINDow<n>][:SUBWindow<w>]:ZOOM:MULTiple<zn>:AREA.....    | 758 |
| DISPlay[:WINDow<n>][:SUBWindow<w>]:ZOOM:MULTiple<zn>[:STATe]..... | 759 |

**DISPlay[:WINDow<n>][:SUBWindow<w>]:ZOOM:MULTiple<zn>:AREA**  
 <x1>,<y1>,<x2>,<y2>

This command defines the zoom area for a multiple zoom.

To define a zoom area, you first have to turn the zoom on.

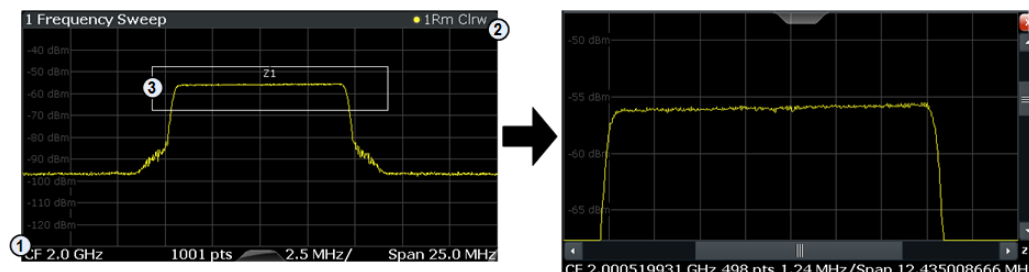

- 1 = origin of coordinate system (x1 = 0, y1 = 0)
- 2 = end point of system (x2 = 100, y2 = 100)
- 3 = zoom area (e.g. x1 = 60, y1 = 30, x2 = 80, y2 = 75)

#### Suffix:

- <n> [Window](#)
- <w> subwindow
- <zn> Selects the zoom window.

#### Parameters:

- <x1> Diagram coordinates in % of the complete diagram that define the zoom area.  
The lower left corner is the origin of coordinate system. The upper right corner is the end point of the system.  
Range: 0 to 100  
Default unit: PCT
- <y1> Diagram coordinates in % of the complete diagram that define the zoom area.  
The lower left corner is the origin of coordinate system. The upper right corner is the end point of the system.  
Range: 0 to 100  
Default unit: PCT
- <x2> Diagram coordinates in % of the complete diagram that define the zoom area.  
The lower left corner is the origin of coordinate system. The upper right corner is the end point of the system.  
Range: 0 to 100  
Default unit: PCT

<y2> Diagram coordinates in % of the complete diagram that define the zoom area.  
The lower left corner is the origin of coordinate system. The upper right corner is the end point of the system.  
Range: 0 to 100  
Default unit: PCT

**Manual operation:** See " [Multi-Zoom](#) " on page 556

---

**DISPlay[:WINDow<n>][:SUBWindow<w>]:ZOOM:MULTiple<zn>[:STATe] <State>**

This command turns the multiple zoom on and off.

**Suffix:**

<n> [Window](#)

<w> subwindow

<zn> Selects the zoom window.  
If you turn off one of the zoom windows, all subsequent zoom windows move up one position.

**Parameters:**

<State> ON | OFF | 0 | 1  
**OFF | 0**  
Switches the function off  
**ON | 1**  
Switches the function on

**Manual operation:** See " [Multi-Zoom](#) " on page 556  
See " [Restore Original Display](#) " on page 557

## 9.8.7 Configuring the Trace Display and Retrieving Trace Data

The commands required to work with traces are described here.



Commands required to export traces (and other result data) are described in [Chapter 9.9.5, "Storing Measurement Results"](#), on page 886.

---

- [Configuring Standard Traces](#)..... 760
- [Configuring Spectrograms](#)..... 765
- [Using Trace Mathematics](#)..... 773
- [Retrieving Trace Results](#)..... 775
- [Formats for Returned Values: ASCII Format and Binary Format](#)..... 779
- [Importing and Exporting Traces](#)..... 779
- [Programming Example: Configuring a Spectrogram](#)..... 781

### 9.8.7.1 Configuring Standard Traces

#### Useful commands for trace configuration described elsewhere

- `DISPlay[:WINDow<n>][:SUBWindow<w>]:TRACe<t>:Y:SPACing` on page 734
- `DISPlay[:WINDow<n>]:TRACe<t>:Y[:SCALe]` on page 732

#### Remote commands exclusive to trace configuration

|                                                                                                     |     |
|-----------------------------------------------------------------------------------------------------|-----|
| <code>DISPlay[:WINDow&lt;n&gt;]:TRACe&lt;t&gt;:MODE</code> .....                                    | 760 |
| <code>DISPlay[:WINDow&lt;n&gt;][:SUBWindow&lt;w&gt;]:TRACe&lt;t&gt;:MODE:HCONTinuous</code> .....   | 761 |
| <code>DISPlay[:WINDow&lt;n&gt;][:SUBWindow&lt;w&gt;]:TRACe&lt;t&gt;[:STATe]</code> .....            | 762 |
| <code>DISPlay[:WINDow&lt;n&gt;][:SUBWindow&lt;w&gt;]:TRACe&lt;t&gt;:SMOothing:APERture</code> ..... | 762 |
| <code>DISPlay[:WINDow&lt;n&gt;][:SUBWindow&lt;w&gt;]:TRACe&lt;t&gt;:SMOothing[:STATe]</code> .....  | 762 |
| <code>[SENSe:]AVERAge&lt;n&gt;:COUNT</code> .....                                                   | 763 |
| <code>[SENSe:]AVERAge&lt;n&gt;[:STATe&lt;t&gt;]</code> .....                                        | 763 |
| <code>[SENSe:]AVERAge&lt;n&gt;:TYPE</code> .....                                                    | 764 |
| <code>[SENSe:][WINDow&lt;n&gt;]:DETector&lt;t&gt;[:FUNCTion]</code> .....                           | 764 |
| <code>[SENSe:][WINDow&lt;n&gt;]:DETector&lt;t&gt;[:FUNCTion]:AUTO</code> .....                      | 765 |
| <code>TRACe&lt;n&gt;:COPY</code> .....                                                              | 765 |

---

#### `DISPlay[:WINDow<n>]:TRACe<t>:MODE <Mode>`

This command selects the trace mode. If necessary, the selected trace is also activated.

In case of max hold, min hold or average trace mode, you can set the number of single measurements with `[SENSe:]SWEep:COUNT`. Note that synchronization to the end of the measurement is possible only in single sweep mode.

#### Suffix:

<n>                      Window

<t>                      Trace

#### Parameters:

<Mode>

#### **WRITE**

Overwrite mode: the trace is overwritten by each sweep. This is the default setting.

#### **AVERAge**

The average is formed over several sweeps. The "Sweep/Average Count" determines the number of averaging procedures.

#### **MAXHold**

The maximum value is determined over several sweeps and displayed. The R&S FPL1000 saves the sweep result in the trace memory only if the new value is greater than the previous one.



**MINHold**

The minimum value is determined from several measurements and displayed. The R&S FPL1000 saves the sweep result in the trace memory only if the new value is lower than the previous one.

**VIEW**

The current contents of the trace memory are frozen and displayed.

**BLANK**

Hides the selected trace.

\*RST: Trace 1: WRITe, Trace 2-6: BLANK

**Example:**

INIT:CONT OFF

Switching to single sweep mode.

SWE:COUN 16

Sets the number of measurements to 16.

DISP:TRAC3:MODE WRIT

Selects clear/write mode for trace 3.

INIT;\*WAI

Starts the measurement and waits for the end of the measurement.

**Manual operation:** See " [Trace Mode](#) " on page 510

---

**DISPlay[:WINDow<n>][:SUBWindow<w>]:TRACe<t>:MODE:HCONtinuous**  
<State>

This command turns an automatic reset of a trace on and off after a parameter has changed.

The reset works for trace modes min hold, max hold and average.

Note that the command has no effect if critical parameters like the span have been changed to avoid invalid measurement results

**Suffix:**

<n> [Window](#)

<w> subwindow

<t> [Trace](#)

**Parameters:**

<State> ON | OFF | 0 | 1

**OFF | 0**

Switches the function off

**ON | 1**

Switches the function on

**Example:**

DISP:WIND:TRAC3:MODE:HCON ON

Switches off the reset function.

**Manual operation:** See " [Hold](#) " on page 511

**DISPlay[:WINDow<n>][:SUBWindow<w>]:TRACe<t>[:STATe] <State>**

This command turns a trace on and off.

The measurement continues in the background.

**Suffix:**

|     |           |
|-----|-----------|
| <n> | Window    |
| <w> | subwindow |
| <t> | Trace     |

**Parameters:**

|         |                           |
|---------|---------------------------|
| <State> | ON   OFF   0   1          |
|         | <b>OFF   0</b>            |
|         | Switches the function off |
|         | <b>ON   1</b>             |
|         | Switches the function on  |

**Example:** DISP:TRAC3 ON

**Manual operation:** See " [Trace 1 / Trace 2 / Trace 3 / Trace 4 / Trace 5 / Trace 6](#) " on page 510  
See " [Trace 1 / Trace 2 / Trace 3 / Trace 4 \(Softkeys\)](#) " on page 513

**DISPlay[:WINDow<n>][:SUBWindow<w>]:TRACe<t>:SMOothing:APERture <Aperture>**

This command defines the degree (aperture) of the trace smoothing, if `DISPlay[:WINDow<n>][:SUBWindow<w>]:TRACe<t>:SMOothing[:STATe]TRUE`.

**Suffix:**

|     |           |
|-----|-----------|
| <n> | Window    |
| <w> | subwindow |
| <t> | Trace     |

**Parameters:**

|            |                   |
|------------|-------------------|
| <Aperture> | Range: 1 to 50    |
|            | *RST: 2           |
|            | Default unit: PCT |

**Example:** DISP3:TRAC2:SMO:APER 5  
Defines an aperture of 5% for trace 2 in window 3

**Manual operation:** See " [Smoothing](#) " on page 512

**DISPlay[:WINDow<n>][:SUBWindow<w>]:TRACe<t>:SMOothing[:STATe] <State>**

This command turns trace smoothing for a particular trace on and off.

If enabled, the trace is smoothed by the value specified using `DISPlay[:WINDow<n>][:SUBWindow<w>]:TRACe<t>:SMOothing:APERture` on page 762.

For more information see "[Trace Smoothing](#)" on page 508.

**Suffix:**

<n> [Window](#)

<w> subwindow

<t> [Trace](#)

**Parameters:**

<State> ON | OFF | 0 | 1

**OFF | 0**

Switches the function off

**ON | 1**

Switches the function on

**Example:**

DISP3:TRAC2:SMO ON

Turns on trace smoothing for trace 2 in window 3

**Manual operation:** See "[Smoothing](#)" on page 512

**[SENSe:]AVERage<n>:COUNT <AverageCount>**

This command defines the number of sweeps that the application uses to average traces.

In case of continuous sweep mode, the application calculates the moving average over the average count.

In case of single sweep mode, the application stops the measurement and calculates the average after the average count has been reached.

**Suffix:**

<n> irrelevant

**Parameters:**

<AverageCount> If you set an average count of 0 or 1, the application performs one single sweep in single sweep mode.

In continuous sweep mode, if the average count is set to 0, a moving average over 10 sweeps is performed.

Range: 0 to 200000

\*RST: 0

**Manual operation:** See "[Sweep/Average Count](#)" on page 444

See "[Average Count](#)" on page 512

**[SENSe:]AVERage<n>[:STATe<t>] <State>**

This command turns averaging for a particular trace in a particular window on and off.

**Suffix:**

<n> [Window](#)

<t> [Trace](#)

**Parameters:**

<State> ON | OFF | 1 | 0

**[SENSe:]AVERAge<n>:TYPE <Mode>**

This command selects the trace averaging mode.

**Suffix:**

<n> 1..n  
Window

**Parameters:**

<Mode>

**VIDeo**

The logarithmic power values are averaged.

**LINear**

The power values are averaged before they are converted to logarithmic values.

**POWER**

The power level values are converted into unit Watt prior to averaging. After the averaging, the data is converted back into its original unit.

\*RST: VIDEo

**Example:**

AVER:TYPE LIN

Switches to linear average calculation.

**Manual operation:** See " [Average Mode](#) " on page 512

**[SENSe:][WINDow<n>:]DETEctor<t>[:FUNction] <Detector>**

Defines the trace detector to be used for trace analysis.

For details see "[Mapping Samples to sweep Points with the Trace Detector](#)" on page 503.

For EMI measurements, the trace detector is used for the initial peak search only, not for the final test. The detector for the final test is configured using [CALCulate<n>:MARKer<m>:FUNction:FMEasurement:DETEctor](#) on page 684.

**Suffix:**

<n> Window  
<t> Trace

**Parameters:**

<Detector>

**APEak**

Autopeak

**NEGative**

Negative peak

**POSitive**

Positive peak

**SAMPlE**

First value detected per trace point

**RMS**

RMS value

**AVERAge**

Average

\*RST: APEak

**Example:** DET POS  
Sets the detector to "positive peak".

**Manual operation:** See " [Detector](#) " on page 511

**[SENSe:][WINDow<n>:]DETEctor<t>[:FUNction]:AUTO <State>**

This command couples and decouples the detector to the trace mode.

**Suffix:**<n> [Window](#)<t> [Trace](#)**Parameters:**

&lt;State&gt; ON | OFF | 0 | 1

\*RST: 1

**Example:** DET:AUTO OFF  
The selection of the detector is not coupled to the trace mode.

**Manual operation:** See " [Detector](#) " on page 511

**TRACe<n>:COPY <TraceNumber>, <TraceNumber>**

This command copies data from one trace to another.

**Suffix:**<n> [Window](#)**Parameters:**<TraceNumber> **TRACE1 | TRACE2 | TRACE3 | TRACE4 | TRACE5 | TRACE6**

The first parameter is the destination trace, the second parameter is the source.

(Note the 'e' in the parameter is required!)

**Example:** TRAC:COPY TRACE1, TRACE2  
Copies the data from trace 2 to trace 1.

**Manual operation:** See " [Copy Trace](#) " on page 513

### 9.8.7.2 Configuring Spectrograms

In addition to the standard "level versus frequency" or "level versus time" spectrum traces, the R&S FPL1000 also provides a spectrogram display of the measured data. A spectrogram shows how the spectral density of a signal varies over time. The x-axis

shows the frequency, the y-axis shows the time. The commands required to configure spectrograms in a remote environment are described here. For details and manual operation see [Chapter 8.10.2.2, "Spectrogram Settings"](#), on page 524.



When configuring spectrograms, the window suffix is irrelevant. The settings are always applied to the spectrogram window, or to all spectrogram windows, if several are active for the same channel setup.

For commands to set markers in spectrograms, see [Chapter 9.8.8.6, "Marker Search \(Spectrograms\)"](#), on page 803.

|                                            |     |
|--------------------------------------------|-----|
| Configuring a Spectrogram Measurement..... | 766 |
| Configuring the Color Map.....             | 771 |

### Configuring a Spectrogram Measurement

|                                                                        |     |
|------------------------------------------------------------------------|-----|
| <a href="#">CALCulate&lt;n&gt;:SGRam:CLEar[:IMMediate]</a> .....       | 766 |
| <a href="#">CALCulate&lt;n&gt;:SPEctrogram:CLEar[:IMMediate]</a> ..... | 766 |
| <a href="#">CALCulate&lt;n&gt;:SGRam:CONTinuous</a> .....              | 767 |
| <a href="#">CALCulate&lt;n&gt;:SPEctrogram:CONTinuous</a> .....        | 767 |
| <a href="#">CALCulate&lt;n&gt;:SGRam:FRAMe:COUNT</a> .....             | 767 |
| <a href="#">CALCulate&lt;n&gt;:SPEctrogram:FRAMe:COUNT</a> .....       | 767 |
| <a href="#">CALCulate&lt;n&gt;:SGRam:FRAMe:SElect</a> .....            | 768 |
| <a href="#">CALCulate&lt;n&gt;:SPEctrogram:FRAMe:SElect</a> .....      | 768 |
| <a href="#">CALCulate&lt;n&gt;:SGRam:HDEPth</a> .....                  | 768 |
| <a href="#">CALCulate&lt;n&gt;:SPEctrogram:HDEPth</a> .....            | 768 |
| <a href="#">CALCulate&lt;n&gt;:SGRam:LAYout</a> .....                  | 768 |
| <a href="#">CALCulate&lt;n&gt;:SPEctrogram:LAYout</a> .....            | 768 |
| <a href="#">CALCulate&lt;n&gt;:SGRam[:STATe]</a> .....                 | 769 |
| <a href="#">CALCulate&lt;n&gt;:SPEctrogram[:STATe]</a> .....           | 769 |
| <a href="#">CALCulate&lt;n&gt;:SGRam:THReedim[:STATe]</a> .....        | 769 |
| <a href="#">CALCulate&lt;n&gt;:SPEctrogram:THReedim[:STATe]</a> .....  | 769 |
| <a href="#">CALCulate&lt;n&gt;:SGRam:TRACe</a> .....                   | 770 |
| <a href="#">CALCulate&lt;n&gt;:SPEctrogram:TRACe</a> .....             | 770 |
| <a href="#">CALCulate&lt;n&gt;:SGRam:TSTamp:DATA?</a> .....            | 770 |
| <a href="#">CALCulate&lt;n&gt;:SPEctrogram:TSTamp:DATA?</a> .....      | 770 |
| <a href="#">CALCulate&lt;n&gt;:SGRam:TSTamp[:STATe]</a> .....          | 771 |
| <a href="#">CALCulate&lt;n&gt;:SPEctrogram:TSTamp[:STATe]</a> .....    | 771 |

#### **CALCulate<n>:SGRam:CLEar[:IMMediate]**

#### **CALCulate<n>:SPEctrogram:CLEar[:IMMediate]**

This command resets the spectrogram and clears the history buffer.

#### **Suffix:**

|     |            |
|-----|------------|
| <n> | 1..n       |
|     | irrelevant |

#### **Example:**

```
CALC:SGR:CLE
Resets the result display and clears the memory.
```

**Manual operation:** See "[Clear Spectrogram](#)" on page 447

---

**CALCulate<n>:SGRam:CONTInuous <State>**

**CALCulate<n>:SPECtrogram:CONTInuous <State>**

This command determines whether the results of the last measurement are deleted before starting a new measurement in single sweep mode.

This setting applies to all spectrograms in the channel setup.

**Suffix:**

<n> irrelevant

**Parameters:**

<State> ON | OFF | 0 | 1

**OFF | 0**

Switches the function off

**ON | 1**

Switches the function on

**Example:**

INIT:CONT OFF

Selects single sweep mode.

INIT;\*WAI

Starts the sweep and waits for the end of the sweep.

CALC:SGR:CONT ON

Repeats the single sweep measurement without deleting the results of the last measurement.

**Manual operation:** See "[Single Sweep / Run Single](#)" on page 445  
See "[Continue Frame](#)" on page 447

---

**CALCulate<n>:SGRam:FRAMe:COUNT <Frames>**

**CALCulate<n>:SPECtrogram:FRAMe:COUNT <Frames>**

This command defines the number of frames to be recorded in a single sweep.

This value applies to all spectrograms in the channel setup.

**Suffix:**

<n> irrelevant

**Parameters:**

<Frames> The maximum number of frames depends on the history depth.

Range: 1 to history depth

Increment: 1

\*RST: 1

**Example:**

INIT:CONT OFF

Selects single sweep mode.

CALC:SGR:FRAM:COUN 200

Sets the number of frames to 200.

**Manual operation:** See "[Frame Count](#)" on page 447

---

**CALCulate<n>:SGRam:FRAMe:SElect <Frame> | <Time>**  
**CALCulate<n>:SPECtrogram:FRAMe:SElect <Frame> | <Time>**

This command selects a specific frame for further analysis.

The command is available if no measurement is running or after a single sweep has ended.

**Suffix:**

<n> irrelevant

**Parameters:**

<Frame> Selects a frame directly by the frame number. Valid if the time stamp is off.  
 The range depends on the history depth.  
 Default unit: S

<Time> Selects a frame via its time stamp. Valid if the time stamp is on.  
 The number is the distance to frame 0 in seconds. The range depends on the history depth.

**Example:**

```
INIT:CONT OFF
Stop the continuous sweep.
CALC:SGR:FRAM:SEL -25
Selects frame number -25.
```

**Manual operation:** See "[Select Frame](#)" on page 447

---

**CALCulate<n>:SGRam:HDEPth <History>**  
**CALCulate<n>:SPECtrogram:HDEPth <History>**

This command defines the number of frames to be stored in the R&S FPL1000 memory.

**Suffix:**

<n> irrelevant

**Parameters:**

<History> The maximum number of frames depends on the number of sweep points.  
 Range: 781 to 20000  
 Increment: 1  
 \*RST: 3000

**Example:**

```
CALC:SGR:SPEC 1500
Sets the history depth to 1500.
```

**Manual operation:** See "[History Depth](#)" on page 526

---

**CALCulate<n>:SGRam:LAYout <State>**  
**CALCulate<n>:SPECtrogram:LAYout <State>**

This command selects the state and size of spectrograms.

The command is available for result displays that support spectrograms.



**Suffix:**<n> [Window](#)**Parameters:**

&lt;State&gt;

**ON**

Spectrogram and trace diagram share a window.

**OFF**

Only the trace diagram is displayed, the spectrogram is not.

\*RST: OFF

**Example:**

CALC4:SPEC:LAY FULL

Shows the spectrogram in window 4. The corresponding trace diagram is hidden.

**Manual operation:** See ["State"](#) on page 525**CALCulate<n>:SGRam[:STATe] <State>****CALCulate<n>:SPECtrogram[:STATe] <State>**

This command turns the spectrogram on and off.

**Parameters:**

&lt;State&gt;

ON | OFF | 0 | 1

**OFF | 0**

Switches the function off

**ON | 1**

Switches the function on

**Example:**

CALC:SGR ON

Activates the Spectrogram result display.

**CALCulate<n>:SGRam:THReedim[:STATe] <State>****CALCulate<n>:SPECtrogram:THReedim[:STATe] <State>**

Activates or deactivates a 3-dimensional spectrogram for the selected result display.

**Suffix:**<n> [Window](#)**Parameters:**

&lt;State&gt;

ON | OFF | 0 | 1

**OFF | 0**

Switches the function off

**ON | 1**

Switches the function on

\*RST: 0

**Example:**

CALC:SPEC:THR:STAT ON

**Manual operation:** See ["3D Spectrogram State"](#) on page 525

---

**CALCulate**<n>:SGRam:TRACe <Trace>

**CALCulate**<n>:SPECtrogram:TRACe <Trace>

Selects the spectrum diagram trace on which the spectrogram is based.

**Suffix:**

<n> [Window](#)

**Parameters:**

<Trace> TRACe1 | TRACe2 | TRACe3 | TRACe4 | TRACe5 | TRACe6

**Example:**

CALC:SPEC:TRAC TRACe1

---

**CALCulate**<n>:SGRam:TSTamp:DATA? <Frames>

**CALCulate**<n>:SPECtrogram:TSTamp:DATA? <Frames>

This command queries the starting time of the frames.

The return values consist of four values for each frame. If the Spectrogram is empty, the command returns '0,0,0,0'. The times are given as delta values, which simplifies evaluating relative results; however, you can also calculate the absolute date and time as displayed on the screen.

The frame results themselves are returned with TRAC:DATA? SGR

See [TRACe<n> \[ :DATA \]](#) on page 776.

**Suffix:**

<n> irrelevant

**Query parameters:**

<Frames>

**CURRENT**

Returns the starting time of the current frame.

**ALL**

Returns the starting time for all frames. The results are sorted in descending order, beginning with the current frame.

**Return values:**

<Seconds>

Number of seconds that have passed since 01.01.1970 till the frame start

<Nanoseconds>

Number of nanoseconds that have passed *in addition to the* <Seconds> since 01.01.1970 till the frame start.

<Reserved>

The third value is reserved for future uses.

<Reserved>

The fourth value is reserved for future uses.

**Example:**

CALC:SGR:TST ON

Activates the time stamp.

CALC:SGR:TST:DATA? ALL

Returns the starting times of all frames sorted in a descending order.

**Usage:**

Query only

**Manual operation:**

See "[Time Stamp](#)" on page 526

**CALCulate<n>:SGRam:TSTamp[:STATe] <State>**

**CALCulate<n>:SPECTrogram:TSTamp[:STATe] <State>**

This command activates and deactivates the time stamp.

If the time stamp is active, some commands do not address frames as numbers, but as (relative) time values:

- [CALCulate<n>:DELTaMarker<m>:SPECTrogram:FRaME](#) on page 809
- [CALCulate<n>:MARKer<m>:SPECTrogram:FRaME](#) on page 804
- [CALCulate<n>:SPECTrogram:FRaME:SELEct](#) on page 768

**Suffix:**

<n>                      irrelevant

**Parameters:**

<State>                      ON | OFF | 0 | 1

**OFF | 0**

Switches the function off

**ON | 1**

Switches the function on

**Example:**

CALC:SGR:TST ON

Activates the time stamp.

**Manual operation:** See " [Time Stamp](#) " on page 526

**Configuring the Color Map**

|                                                                           |     |
|---------------------------------------------------------------------------|-----|
| <a href="#">DISPlay[:WINDow&lt;n&gt;]:SGRam:COLor:DEFault</a> .....       | 771 |
| <a href="#">DISPlay[:WINDow&lt;n&gt;]:SPECTrogram:COLor:DEFault</a> ..... | 771 |
| <a href="#">DISPlay[:WINDow&lt;n&gt;]:SGRam:COLor:LOWer</a> .....         | 772 |
| <a href="#">DISPlay[:WINDow&lt;n&gt;]:SPECTrogram:COLor:LOWer</a> .....   | 772 |
| <a href="#">DISPlay[:WINDow&lt;n&gt;]:SGRam:COLor:SHAPE</a> .....         | 772 |
| <a href="#">DISPlay[:WINDow&lt;n&gt;]:SPECTrogram:COLor:SHAPE</a> .....   | 772 |
| <a href="#">DISPlay[:WINDow&lt;n&gt;]:SGRam:COLor:UPPer</a> .....         | 772 |
| <a href="#">DISPlay[:WINDow&lt;n&gt;]:SPECTrogram:COLor:UPPer</a> .....   | 772 |
| <a href="#">DISPlay[:WINDow&lt;n&gt;]:SGRam:COLor[:STYLe]</a> .....       | 773 |
| <a href="#">DISPlay[:WINDow&lt;n&gt;]:SPECTrogram:COLor[:STYLe]</a> ..... | 773 |

**DISPlay[:WINDow<n>]:SGRam:COLor:DEFault**

**DISPlay[:WINDow<n>]:SPECTrogram:COLor:DEFault**

This command restores the original color map.

**Suffix:**

<n>                      [Window](#)

**Manual operation:** See " [Set to Default](#) " on page 529

---

**DISPlay[:WINDow<n>]:SGRam:COLor:LOWer** <Percentage>

**DISPlay[:WINDow<n>]:SPECtrogram:COLor:LOWer** <Percentage>

This command defines the starting point of the color map.

**Suffix:**

<n> [Window](#)

**Parameters:**

<Percentage> Statistical frequency percentage.  
 Range: 0 to 66  
 \*RST: 0  
 Default unit: %

**Example:**

DISP:WIND:SGR:COL:LOW 10

Sets the start of the color map to 10%.

**Manual operation:** See "[Start / Stop](#)" on page 528

---

**DISPlay[:WINDow<n>]:SGRam:COLor:SHAPE** <Shape>

**DISPlay[:WINDow<n>]:SPECtrogram:COLor:SHAPE** <Shape>

This command defines the shape and focus of the color curve for the spectrogram result display.

**Suffix:**

<n> [Window](#)

**Parameters:**

<Shape> Shape of the color curve.  
 Range: -1 to 1  
 \*RST: 0

**Manual operation:** See "[Shape](#)" on page 528

---

**DISPlay[:WINDow<n>]:SGRam:COLor:UPPer** <Percentage>

**DISPlay[:WINDow<n>]:SPECtrogram:COLor:UPPer** <Percentage>

This command defines the end point of the color map.

**Suffix:**

<n> [Window](#)

**Parameters:**

<Percentage> Statistical frequency percentage.  
 Range: 0 to 66  
 \*RST: 0  
 Default unit: %

**Example:**

DISP:WIND:SGR:COL:UPP 95

Sets the start of the color map to 95%.

**Manual operation:** See "[Start / Stop](#)" on page 528

---

**DISPlay[:WINDow<n>]:SGRam:COLor[:STYLE] <ColorScheme>**

**DISPlay[:WINDow<n>]:SPEctrogram:COLor[:STYLE] <ColorScheme>**

This command selects the color scheme.

**Parameters:**

<ColorScheme>

**HOT**

Uses a color range from blue to red. Blue colors indicate low levels, red colors indicate high ones.

**COLD**

Uses a color range from red to blue. Red colors indicate low levels, blue colors indicate high ones.

**RADar**

Uses a color range from black over green to light turquoise with shades of green in between.

**GRAYscale**

Shows the results in shades of gray.

\*RST: HOT

**Example:**

DISP:WIND:SPEC:COL GRAY

Changes the color scheme of the spectrogram to black and white.

**Manual operation:** See " [Hot / Cold / Radar / Grayscale](#) " on page 529

### 9.8.7.3 Using Trace Mathematics

The following commands control trace mathematics.

|                                                 |     |
|-------------------------------------------------|-----|
| CALCulate<n>:MATH<t>[:EXPRession][:DEFine]..... | 773 |
| CALCulate<n>:MATH<t>:MODE.....                  | 774 |
| CALCulate<n>:MATH<t>:POSition.....              | 774 |
| CALCulate<n>:MATH<t>:STATe.....                 | 775 |

---

**CALCulate<n>:MATH<t>[:EXPRession][:DEFine] <Expression>**

This command selects the mathematical expression for trace mathematics.

Before you can use the command, you have to turn trace mathematics on.

**Suffix:**

<n> [Window](#)

<t> irrelevant

**Parameters:**

<Expression>

**(TRACE1-TRACE2)**

Subtracts trace 2 from trace 1.

**(TRACE1-TRACE3)**

Subtracts trace 3 from trace 1.

**(TRACE1-TRACE4)**

Subtracts trace 4 from trace 1.

**(TRACE1-TRACE5)**

Subtracts trace 5 from trace 1.

**(TRACE1-TRACE6)**

Subtracts trace 6 from trace 1.

**Example:**

CALC:MATH:STAT ON

Turns trace mathematics on.

CALC:MATH:EXPR:DEF (TRACE1-TRACE3)

Subtracts trace 3 from trace 1.

**Manual operation:** See "[Trace Math Function](#)" on page 534**CALCulate<n>:MATH<t>:MODE <Mode>**

This command selects the way the R&amp;S FPL1000 calculates trace mathematics.

**Suffix:**<n> [Window](#)

&lt;t&gt; irrelevant

**Parameters:**<Mode> For more information on the way each mode works see [Trace Math Mode](#).**LINear**

Linear calculation.

**LOGarithmic**

Logarithmic calculation.

**POWER**

Linear power calculation.

\*RST: LOGarithmic

**Example:**

CALC:MATH:MODE LIN

Selects linear calculation.

**Manual operation:** See "[Trace Math Mode](#)" on page 534**CALCulate<n>:MATH<t>:POSition <Position>**

This command defines the position of the trace resulting from the mathematical operation.

**Suffix:**<n> [Window](#)

&lt;t&gt; irrelevant

**Parameters:**

<Position> Vertical position of the trace in % of the height of the diagram area.  
 100 PCT corresponds to the upper diagram border.  
 Range: -100 to 200  
 \*RST: 50  
 Default unit: PCT

**Example:**

CALC:MATH:POS 100  
 Moves the trace to the top of the diagram area.

**Manual operation:** See " [Trace Math Position](#) " on page 534

**CALCulate<n>:MATH<t>:STATe <State>**

This command turns the trace mathematics on and off.

**Suffix:**

<n> [Window](#)  
 <t> irrelevant

**Parameters:**

<State> ON | OFF | 0 | 1  
**OFF | 0**  
 Switches the function off  
**ON | 1**  
 Switches the function on

**Example:**

CALC:MATH:STAT ON  
 Turns on trace mathematics.

**Manual operation:** See " [Trace Math Function](#) " on page 534  
 See " [Trace Math Off](#) " on page 534

**9.8.7.4 Retrieving Trace Results**

This chapter describes how to retrieve data from standard traces.

For spectrograms see also [Chapter 9.8.8.6, "Marker Search \(Spectrograms\)"](#), on page 803.

For details on the format of the retrieved trace data see also [Chapter 9.8.7.5, "Formats for Returned Values: ASCII Format and Binary Format"](#), on page 779.



Commands required to export traces (and other result data) are described in [Chapter 9.9.5, "Storing Measurement Results"](#), on page 886.

|                              |     |
|------------------------------|-----|
| FORMat[:DATA].....           | 776 |
| TRACe<n>[:DATA].....         | 776 |
| TRACe<n>[:DATA]:MEMory?..... | 778 |
| TRACe<n>[:DATA]:X?.....      | 778 |

**FORMat[:DATA]** <Format>[, <BitLength>]

This command selects the data format that is used for transmission of trace data from the R&S FPL1000 to the controlling computer.

Note that the command has no effect for data that you send to the R&S FPL1000. The R&S FPL1000 automatically recognizes the data it receives, regardless of the format.

For details on data formats see [Chapter 9.8.7.5, "Formats for Returned Values: ASCII Format and Binary Format"](#), on page 779.

**Parameters:**

<Format>                    ASCII | REAL | UINT | MATLab

**ASCII**

ASCII format, separated by commas.

This format is almost always suitable, regardless of the actual data format. However, the data is not as compact as other formats may be.

**REAL**

Floating-point numbers (according to IEEE 754) in the "definite length block format".

In the Spectrum application, the format setting `REAL` is used for the binary transmission of trace data.

<BitLength>                16 | 32 | 64

Length in bits for floating-point results

**32**

32-bit floating-point numbers

For I/Q data, 8 bytes per sample are returned for this format setting.

**Example:**                FORM REAL, 32

**TRACe<n>[:DATA]** <Trace>,<Data>**TRACe<n>[:DATA]? <ResultType>**

This command queries current trace data and measurement results.

The data format depends on [FORMat\[:DATA\]](#) on page 776.

**Suffix:**

<n>                         [Window](#)

**Parameters:**

<Trace>                    Selects the trace to write the data to.

**TRACE1 | ... | TRACE6**

<Data>                    Contains the data to transfer.

**Query parameters:**

<ResultType>             Selects the type of result to be returned.



**TRACE1 | ... | TRACE6**

Returns the trace data for the corresponding trace.

For details see [Table 9-6](#).

**LIST**

Returns the results of the peak list evaluation for Spurious Emission and Spectrum Emission Mask measurements.

For SEM measurements, one peak per range is returned.

For details see [Table 9-7](#).

**SPURious**

Returns the peak list of Spurious Emission measurements.

**SPECTrogram | SGRam**

Returns the results of the spectrogram result display.

For details see [Table 9-8](#).

**Return values:**

<TraceData> For more information see tables below.

**Example:**

```
TRAC TRACE1,+A$
Transfers trace data ('+A$') to trace 1.
```

**Example:**

```
TRAC? TRACE3
Queries the data of trace 3.
```

**Manual operation:**

See "[Diagram](#)" on page 260  
 See "[List Evaluation State \(Result Summary\)](#)" on page 321  
 See "[List Evaluation State](#)" on page 343

**Table 9-6: Return values for TRACE1 to TRACE6 parameter**

The trace data consists of a list of power levels that have been measured. The number of power levels in the list depends on the currently selected number of sweep points. The unit depends on the measurement and on the unit you have currently set.

If you are measuring with the auto peak detector, the command returns positive peak values only. (To retrieve negative peak values, define a second trace with a negative peak detector.)

For SEM or Spurious Emission measurement results, the x-values should be queried as well, as they are not equidistant (see [TRACe<n>\[:DATA\]:X?](#) on page 778).

**Table 9-7: Return values for LIST parameter**

For each peak, the command returns 11 values in the following order:

<No>,<StartFreq>,<StopFreq>,<RBW>,<PeakFreq>,<PowerAbs>,<PowerRel>,<PowerDelta>,<LimitCheck>,<Unused1>,<Unused2>

- <No>: range number
- <StartFreq>,<StopFreq>: start and stop frequency of the range
- <RBW>: resolution bandwidth
- <PeakFreq>: frequency of the peak in a range
- <PowerAbs>: absolute power of the peak in dBm
- <PowerRel>: power of the peak in relation to the channel power in dBc
- <PowerDelta>: distance from the peak to the limit line in dB, positive values indicate a failed limit check
- <LimitCheck>: state of the limit check (0 = PASS, 1 = FAIL)
- <Unused1>,<Unused2>: reserved (0.0)

**Table 9-8: Return values for SPECTrogram parameter**

For every frame in the spectrogram, the command returns the power levels that have been measured, one for each sweep point. The number of frames depends on the size of the history depth. The power level depends on the unit you have currently set.

---

**TRACe<n>[:DATA]:MEMory? <Trace>,<OffsSwPoint>,<NoOfSwPoints>**

This command queries the previously captured trace data for the specified trace from the memory. As an offset and number of sweep points to be retrieved can be specified, the trace data can be retrieved in smaller portions, making the command faster than the `TRAC:DATA?` command. This is useful if only specific parts of the trace data are of interest.

If no parameters are specified with the command, the entire trace data is retrieved; in this case, the command returns the same results as `TRAC:DATA? TRACE1`.

For details on the returned values see the `TRAC:DATA? <TRACE...>` command.

**Suffix:**

<n> [Window](#)

**Query parameters:**

<Trace> TRACE1 | TRACE2 | TRACE3 | TRACE4 | TRACE5 | TRACE6

<OffsSwPoint> The offset in sweep points related to the start of the measurement at which data retrieval is to start.

<NoOfSwPoints> Number of sweep points to be retrieved from the trace.

**Return values:**

<SweepPointValues>

**Example:**

`TRAC:DATA:MEM? TRACE1,25,100`

Retrieves 100 sweep points from trace 1, starting at sweep point 25.

**Usage:**

Query only

---

**TRACe<n>[:DATA]:X? <TraceNumber>**

This command queries the horizontal trace data for each sweep point in the specified window, for example the frequency in frequency domain or the time in time domain measurements.

This is especially useful for traces with non-equidistant x-values, e.g. for SEM or Spurious Emissions measurements.

**Suffix:**

<n> [Window](#)

**Query parameters:**

<TraceNumber> TRACe1 | TRACe2 | TRACe3 | TRACe4 | TRACe5 | TRACe6

Trace number.

**TRACE1 | ... | TRACE6**

**Return values:**

&lt;X-Values&gt;

**Example:**

TRAC3:X? TRACE1

Returns the x-values for trace 1 in window 3.

**Usage:**

Query only

**9.8.7.5 Formats for Returned Values: ASCII Format and Binary Format**

When trace data is retrieved using the `TRAC:DATA` or `TRAC:IQ:DATA` command, the data is returned in the format defined using the `FORMat[:DATA]` on page 776. The possible formats are described here.

- **ASCII Format (FORMat ASCII):**  
The data is stored as a list of comma-separated values (CSV) of the measured values in floating point format.
- **Binary Format (FORMat REAL,32):**  
The data is stored as binary data (Definite Length Block Data according to IEEE 488.2), each measurement value being formatted in 32-Bit IEEE 754 Floating-Point-Format.  
The schema of the result string is as follows:  
#41024<value1><value2>...<value n> with

|         |                                                                             |
|---------|-----------------------------------------------------------------------------|
| #4      | Number of digits (= 4 in the example) of the following number of data bytes |
| 1024    | Number of following data bytes (= 1024 in the example)                      |
| <Value> | 4-byte floating point value                                                 |



Reading out data in binary format is quicker than in ASCII format. Thus, binary format is recommended for large amounts of data.

**9.8.7.6 Importing and Exporting Traces**

|                                                 |     |
|-------------------------------------------------|-----|
| <code>FORMat:DEXPort:FORMat</code> .....        | 779 |
| <code>FORMat:DEXPort:TRACes</code> .....        | 780 |
| <code>FORMat:DIMPort:TRACes</code> .....        | 780 |
| <code>MMEMory:LOAD&lt;n&gt;:TRACe</code> .....  | 781 |
| <code>MMEMory:STORe&lt;n&gt;:TRACe</code> ..... | 781 |

**FORMat:DEXPort:FORMat <FileFormat>**

Determines the format of the ASCII file to be imported or exported. Depending on the external program in which the data file was created or will be evaluated, a comma-separated list (CSV) or a plain data format (DAT) file may be required.

**Parameters:**

<FileFormat>            CSV | DAT  
\*RST:                    DAT

**Example:** FORM:DEXP:FORM CSV

**Manual operation:** See " [File Type](#) " on page 115

#### **FORMat:DEXPort:TRACes** <Selection>

This command selects the data to be included in a data export file (see [MMEMory:STORe<n>:TRACe](#) on page 781).

For details on exporting data see [Chapter 8.13.2, "Trace/Data Ex/Import"](#), on page 563.

#### **Parameters:**

<Selection>

SINGle | ALL

#### **SINGle**

Only a single trace is selected for export, namely the one specified by the [MMEMory:STORe<n>:TRACe](#) command.

#### **ALL**

Selects all active traces and result tables (e.g. Result Summary, marker peak list etc.) in the current application for export to an ASCII file.

The <trace> parameter for the [MMEMory:STORe<n>:TRACe](#) command is ignored.

\*RST: SINGle

**Manual operation:** See " [Export all Traces and all Table Results](#) " on page 563

#### **FORMat:DIMPort:TRACes** <Selection>

This command selects the data to be included in a data import file (see [MMEMory:LOAD<n>:TRACe](#) on page 781).

For details on importing data see [Chapter 8.13.3, "How to Import Traces"](#), on page 566.

#### **Parameters:**

<Selection>

SINGle | ALL

#### **SINGle**

Only a single trace is selected for import, namely the one specified by the [MMEMory:LOAD<n>:TRACe](#) on page 781 command.

#### **ALL**

Imports several traces at once, overwriting the existing trace data for any active trace in the result display with the same trace number. Data from the import file for currently not active traces is not imported.

The <trace> parameter for the [MMEMory:LOAD<n>:TRACe](#) on page 781 command is ignored.

\*RST: SINGle

**Manual operation:** See " [Import All Traces / Import to Trace](#) " on page 566  
See " [Import ASCII File to Trace](#) " on page 566

---

**MMEMory:LOAD<n>:TRACe** <Trace>, <FileName>

This command imports trace data from the specified window to an ASCII file.

**Suffix:**

<n> [Window](#)

**Parameters:**

<Trace> Number of the trace to be stored  
(This parameter is ignored for [FORMat:DIMPort:TRACes](#) on page 780<sub>ALL</sub>).

<FileName> String containing the path and name of the import file.

---

**MMEMory:STORe<n>:TRACe** <Trace>, <FileName>

This command exports trace data from the specified window to an ASCII file.

For details on the file format see [Chapter 8.13.6, "Reference: ASCII File Export Format"](#), on page 568.

**Suffix:**

<n> [Window](#)

**Parameters:**

<Trace> Number of the trace to be stored  
(This parameter is ignored if the option "Export all Traces and all Table Results" is activated in the Export configuration settings, see [FORMat:DEXPort:TRACes](#) on page 780).

<FileName> String containing the path and name of the target file.

**Example:**

```
MMEM:STOR1:TRAC 1, 'C:\TEST.ASC'
```

Stores trace 1 from window 1 in the file TEST.ASC.

**Manual operation:** See " [Export Trace to ASCII File](#) " on page 114

### 9.8.7.7 Programming Example: Configuring a Spectrogram

This example demonstrates how to configure a spectrogram for a basic frequency sweep in a remote environment. The spectrogram is displayed in addition to the spectrum display, in a new window. In addition, the usage of special spectrogram markers is demonstrated (see [Chapter 9.8.8.6, "Marker Search \(Spectrograms\)"](#), on page 803).



Basic trace settings are demonstrated in the [Chapter 9.6.16, "Programming Example: Performing a Basic Frequency Sweep"](#), on page 700.

```
//-----Preparing the Measurement -----
*RST
```

## Setting Basic Spectrum RF Measurement Parameters

```

//Resets the instrument
LAY:ADD? '1',BEL,SGR
//Displays a new window below window 1 and activates spectrogram display.
//The new window name is returned as a result: '2'.
//The spectrogram is updated with each new sweep.
INIT:CONT OFF
//Selects single sweep mode.

//-----Configuring the Spectrogram-----
CALC:SGR:CLE
//Clears the displayed spectrogram to start a new one.
CALC:SGR:CONT ON
//Configures a continuous spectrogram for a series of measurements.
//The display is not cleared when a new measurement is started.
CALC:SGR:FRAM:COUN 100
//Sets the number of frames to be recorded per sweep to 100.
CALC:SGR:HDEP 1000
//Sets the number of frames to be stored to 1000 (=10 sweeps)
CALC:SGR:TST ON
//Activates a time stamp for each frame.

//-----Configuring the Color Map-----
DISP:WIND:SGR:COL GRAY
//Defines a gray-scaled coloring: low values light gray, high values dark gray.
DISP:WIND:SGR:COL:LOW 30
DISP:WIND:SGR:COL:UPP 70
DISP:WIND:SGR:COL:SHAP 0.8
//Defines a color map for a range that comprises 40% of the measurement range,
//excluding 30% at each end. The colors are not scaled linearly; the light gray
//colors are stretched to distinguish low values better.

//-----Performing the Measurement-----
SWE:COUN 10
//Defines 10 sweeps to be performed per measurement.
INIT;*WAI
//Initiates a new measurement and waits until the sweeps have finished.
//The spectrogram is updated with each new sweep.

//-----Positioning Markers-----
CALC:MARK:SGR:SAR MEM
//Includes all frames in the memory in the search area

CALC:MARK1:SGR:FRAM -1s
//Sets marker 1 to the frame 1 second after measurement begin. (Note the
//negative value!
CALC:MARK1:MIN
//Sets marker 1 to the minimum level in this frame.
CALC:MARK1:SGR:Y:MIN
//Sets marker 1 to the minimum level for the same frequency the marker is

```

## Setting Basic Spectrum RF Measurement Parameters

```

//currently positioned at in all frames.

CALC:MARK2:SGR:XY:MAX
//Sets marker 2 to the maximum level in the entire spectrogram.

CALC:DELT1:SGR:FRAM 3s
//Sets the deltamarker 1 to the frame captured 3 seconds after marker 1. By default
//it is set to the peak of that frame and displays the level difference to marker 1.
//Note the positive value!
CALC:DELT1:MIN
//Sets deltamarker 1 to the minimum level in this frame.

CALC:DELT3:SGR:XY:MAX
//Sets deltamarker 3 to the maximum level in the entire spectrogram. By default
//its value is the difference to marker 1. We will change it to refer to marker 2.
CALC:DELT3:MREF 2
//Deltamarker 3 now refers to marker 2, both are positioned on the maximum of the
//spectrogram. Thus, D3=0. We will move deltamarker 3 to the next peak level
//for the same frequency.
CALC:DELT3:SGR:Y:MAX:NEXT

//-----Retrieving Results-----
CALC:MARK1:X?
CALC:MARK1:Y?
CALC:MARK1:SGR:FRAM?
//Queries the frequency (x), level (y) and frame values of marker 1.

CALC:MARK2:X?
CALC:MARK2:Y?
CALC:MARK2:SGR:FRAM?
//Queries the frequency (x), level (y) and frame values of marker 2.

CALC:DELT1:X?
CALC:DELT1:Y?
CALC:DELT1:SGR:FRAM?
//Queries the frequency (x), level (y) and frame values of deltamarker 1.

CALC:DELT3:X?
CALC:DELT3:Y?
CALC:DELT3:SGR:FRAM?
//Queries the frequency (x), level (y) and frame values of deltamarker 3.

CALC:SGR:TST:DATA? ALL
//Queries the time stamps of all stored frames.
CALC:SGR:FRAM:SEL -1
//Selects the frame that was captured 1 second after measurement start (Note the
//negative value!). This frame is displayed in the Spectrum window.
TRAC:DATA? SGR
//Retrieves the trace data for the spectrogram. For each frame, the power level
//and frequency at each sweep point are returned.

```

```
TRAC:DATA? TRACE1
//Retrieves the trace data for the selected frame only.
```

## 9.8.8 Working with Markers

The commands required to work with markers and marker functions in a remote environment are described here. The tasks for manual operation are described in [Chapter 8.9, "Marker Usage"](#), on page 463.



In the Spectrum application, markers are identical in all windows. Thus, the suffix <n> for the window is generally irrelevant.

|                                                                                     |     |
|-------------------------------------------------------------------------------------|-----|
| • <a href="#">Setting Up Individual Markers</a> .....                               | 784 |
| • <a href="#">General Marker Settings</a> .....                                     | 790 |
| • <a href="#">Configuring and Performing a Marker Search</a> .....                  | 791 |
| • <a href="#">Positioning the Marker</a> .....                                      | 795 |
| • <a href="#">Retrieving Marker Results</a> .....                                   | 801 |
| • <a href="#">Marker Search (Spectrograms)</a> .....                                | 803 |
| • <a href="#">Fixed Reference Marker Settings</a> .....                             | 812 |
| • <a href="#">Marker Peak Lists</a> .....                                           | 814 |
| • <a href="#">Noise Measurement Marker</a> .....                                    | 818 |
| • <a href="#">Phase Noise Measurement Marker</a> .....                              | 819 |
| • <a href="#">Band Power Marker</a> .....                                           | 822 |
| • <a href="#">n dB Down Marker</a> .....                                            | 826 |
| • <a href="#">Signal Count Marker</a> .....                                         | 829 |
| • <a href="#">Marker Demodulation</a> .....                                         | 831 |
| • <a href="#">Programming Examples for Using Markers and Marker Functions</a> ..... | 834 |

### 9.8.8.1 Setting Up Individual Markers

The following commands define the position of markers in the diagram.

|                                                                                         |     |
|-----------------------------------------------------------------------------------------|-----|
| <a href="#">CALCulate&lt;n&gt;:DELTaMarker&lt;m&gt;:AOFF</a> .....                      | 785 |
| <a href="#">CALCulate&lt;n&gt;:DELTaMarker&lt;m&gt;:LINK</a> .....                      | 785 |
| <a href="#">CALCulate&lt;n&gt;:DELTaMarker&lt;ms&gt;:LINK:TO:MARKer&lt;md&gt;</a> ..... | 785 |
| <a href="#">CALCulate&lt;n&gt;:DELTaMarker&lt;m&gt;:MODE</a> .....                      | 786 |
| <a href="#">CALCulate&lt;n&gt;:DELTaMarker&lt;m&gt;:MREFerence</a> .....                | 786 |
| <a href="#">CALCulate&lt;n&gt;:DELTaMarker&lt;m&gt;[:STATe]</a> .....                   | 787 |
| <a href="#">CALCulate&lt;n&gt;:DELTaMarker&lt;m&gt;:TRACe</a> .....                     | 787 |
| <a href="#">CALCulate&lt;n&gt;:DELTaMarker&lt;m&gt;:X</a> .....                         | 787 |
| <a href="#">CALCulate&lt;n&gt;:MARKer&lt;m&gt;:AOFF</a> .....                           | 788 |
| <a href="#">CALCulate&lt;n&gt;:MARKer&lt;ms&gt;:LINK:TO:MARKer&lt;md&gt;</a> .....      | 788 |
| <a href="#">CALCulate&lt;n&gt;:MARKer&lt;m&gt;[:STATe]</a> .....                        | 789 |
| <a href="#">CALCulate&lt;n&gt;:MARKer&lt;m&gt;:TRACe</a> .....                          | 789 |
| <a href="#">CALCulate&lt;n&gt;:MARKer&lt;m&gt;:X</a> .....                              | 789 |



**CALCulate<n>:DELTaMarker<m>:AOFF**

This command turns off *all* delta markers.

**Suffix:**

<n> [Window](#)

<m> irrelevant

**Example:**

CALC:DELT:AOff

Turns off all delta markers.

**CALCulate<n>:DELTaMarker<m>:LINK <State>**

This command links delta marker <m> to marker 1.

If you change the horizontal position (x-value) of marker 1, delta marker <m> changes its horizontal position to the same value.

**Tip:** to link any marker to a different marker than marker 1, use the [CALCulate<n>:DELTaMarker<ms>:LINK:TO:MARKer<md>](#) or [CALCulate<n>:MARKer<ms>:LINK:TO:MARKer<md>](#) commands.

**Suffix:**

<n> [Window](#)

<m> [Marker](#)

**Parameters:**

<State> ON | OFF | 0 | 1

**OFF | 0**

Switches the function off

**ON | 1**

Switches the function on

**Example:**

CALC:DELT2:LINK ON

**Manual operation:** See "[Linking to Another Marker](#)" on page 397

**CALCulate<n>:DELTaMarker<ms>:LINK:TO:MARKer<md> <State>**

This command links delta marker <m1> to any active normal marker <m2>.

If you change the horizontal position of marker <m2>, delta marker <m1> changes its horizontal position to the same value.

**Suffix:**

<n> [Window](#)

<ms> source marker, see [Marker](#)

<md> destination marker, see [Marker](#)

**Parameters:**

<State> ON | OFF | 0 | 1

**OFF | 0**

Switches the function off

**ON | 1**

Switches the function on

**Example:** `CALC:DELTA4:LINK:TO:MARK2 ON`  
Links the delta marker 4 to the marker 2.

**Manual operation:** See "[Linking to Another Marker](#)" on page 397

**CALCulate<n>:DELTAmarker<m>:MODE <Mode>**

This command defines whether the position of a delta marker is provided as an absolute value or relative to a reference marker.

Note that when the position of a delta marker is *queried*, the result is always an absolute value (see `CALCulate<n>:DELTAmarker<m>:X` on page 787)!

**Suffix:**

<n> [Window](#)

<m> irrelevant

**Parameters:**

<Mode>

**ABSolute**

Delta marker position in absolute terms.

**RELative**

Delta marker position in relation to a reference marker.

\*RST: RELative

**Example:** `CALC:DELTA:MODE ABS`  
Absolute delta marker position.

**CALCulate<n>:DELTAmarker<m>:MREFerence <Reference>**

This command selects a reference marker for a delta marker other than marker 1.

The reference may be another marker or the fixed reference.

**Suffix:**

<n> [Window](#)

<m> [Marker](#)

**Parameters:**

<Reference>

**FIXed**

Selects the fixed reference as the reference.

**Example:** `CALC:DELTA3:MREF 2`  
Specifies that the values of delta marker 3 are relative to marker 2.

**Manual operation:** See "[Reference Marker](#)" on page 397

**CALCulate<n>:DELTamarker<m>[:STATE] <State>**

This command turns delta markers on and off.

If necessary, the command activates the delta marker first.

No suffix at DELTmarker turns on delta marker 1.

**Suffix:**

<n> [Window](#)

<m> [Marker](#)

**Parameters:**

<State> ON | OFF | 0 | 1

**OFF | 0**

Switches the function off

**ON | 1**

Switches the function on

**Example:**

CALC:DELT2 ON

Turns on delta marker 2.

**Manual operation:**

See "[Marker State](#)" on page 397

See "[Marker Type](#)" on page 397

See "[Select Marker](#)" on page 399

**CALCulate<n>:DELTamarker<m>:TRACe <Trace>**

This command selects the trace a delta marker is positioned on.

Note that the corresponding trace must have a trace mode other than "Blank".

If necessary, the command activates the marker first.

**Suffix:**

<n> [Window](#)

<m> [Marker](#)

**Parameters:**

<Trace> Trace number the marker is assigned to.

**Example:**

CALC:DELT2:TRAC 2

Positions delta marker 2 on trace 2.

**CALCulate<n>:DELTamarker<m>:X <Position>**

This command moves a delta marker to a particular coordinate on the x-axis.

If necessary, the command activates the delta marker and positions a reference marker to the peak power.

**Suffix:**

<n> [Window](#)

<m> [Marker](#)

**Parameters:**

<Position>

Numeric value that defines the marker position on the x-axis. The position is relative to the reference marker.

To select an absolute position you have to change the delta marker mode with `CALCulate<n>:DELTAmarker<m>:MODE` on page 786.

A query returns the absolute position of the delta marker.

Range: The value range and unit depend on the measurement and scale of the x-axis.

Default unit: HZ

**Example:**

`CALC:DELT:X?`

Outputs the absolute x-value of delta marker 1.

**Manual operation:**

See " [Marker 1 / Marker 2 / Marker 3 / Marker 4](#) " on page 378

See " [Marker 1 / Marker 2 / Marker 3](#) " on page 383

See " [Marker Position X-value](#) " on page 397

**CALCulate<n>:MARKer<m>:AOFF**

This command turns off all markers.

**Suffix:**

<n> [Window](#)

<m> [Marker](#)

**Example:**

`CALC:MARK:AOFF`

Switches off all markers.

**Manual operation:**

See " [All Marker Off](#) " on page 470

**CALCulate<n>:MARKer<ms>:LINK:TO:MARKer<md> <State>**

This command links normal marker <m1> to any active normal marker <m2>.

If you change the horizontal position of marker <m2>, marker <m1> changes its horizontal position to the same value.

**Suffix:**

<n> [Window](#)

<ms> source marker, see [Marker](#)

<md> destination marker, see [Marker](#)

**Parameters:**

<State> ON | OFF | 0 | 1

**OFF | 0**

Switches the function off

**ON | 1**

Switches the function on

**Example:** `CALC:MARK4:LINK:TO:MARK2 ON`  
Links marker 4 to marker 2.

**Manual operation:** See "[Linking to Another Marker](#)" on page 397

#### **CALCulate<n>:MARKer<m>[:STATe] <State>**

This command turns markers on and off. If the corresponding marker number is currently active as a delta marker, it is turned into a normal marker.

**Suffix:**

<n> [Window](#)

<m> [Marker](#)

**Parameters:**

<State> ON | OFF | 0 | 1

**OFF | 0**

Switches the function off

**ON | 1**

Switches the function on

**Example:** `CALC:MARK3 ON`  
Switches on marker 3.

**Manual operation:** See "[Marker State](#)" on page 397  
See "[Marker Type](#)" on page 397  
See "[Select Marker](#)" on page 399

#### **CALCulate<n>:MARKer<m>:TRACe <Trace>**

This command selects the trace the marker is positioned on.

Note that the corresponding trace must have a trace mode other than "Blank".

If necessary, the command activates the marker first.

**Suffix:**

<n> [Window](#)

<m> [Marker](#)

**Parameters:**

<Trace> **1 to 6**  
Trace number the marker is assigned to.

**Example:** `//Assign marker to trace 1`  
`CALC:MARK3:TRAC 2`

**Manual operation:** See "[Assigning the Marker to a Trace](#)" on page 398

#### **CALCulate<n>:MARKer<m>:X <Position>**

This command moves a marker to a specific coordinate on the x-axis.

If necessary, the command activates the marker.

If the marker has been used as a delta marker, the command turns it into a normal marker.

**Suffix:**

<n> [Window](#)

<m> [Marker](#)

**Parameters:**

<Position> Numeric value that defines the marker position on the x-axis.  
The unit depends on the result display.

Range: The range depends on the current x-axis range.  
Default unit: Hz

**Example:**

CALC:MARK2:X 1.7MHz

Positions marker 2 to frequency 1.7 MHz.

**Manual operation:**

See "[Marker Table](#)" on page 260

See "[Marker Peak List](#)" on page 261

See "[Marker 1 / Marker 2 / Marker 3 / Marker 4](#)" on page 378

See "[Marker 1 / Marker 2 / Marker 3](#)" on page 383

See "[Marker Position X-value](#)" on page 397

**9.8.8.2 General Marker Settings**

The following commands control general marker functionality.

**Remote commands exclusive to general marker functionality**

|                                                                  |     |
|------------------------------------------------------------------|-----|
| <a href="#">DISPlay[:WINDow&lt;n&gt;]:MTABLE</a> .....           | 790 |
| <a href="#">DISPlay[:WINDow&lt;n&gt;]:MINFo[:STATe]</a> .....    | 791 |
| <a href="#">CALCulate&lt;n&gt;:MARKer&lt;m&gt;:X:SSize</a> ..... | 791 |

**DISPlay[:WINDow<n>]:MTABLE <DisplayMode>**

This command turns the marker table on and off.

**Suffix:**

<n> irrelevant

**Parameters:**

<DisplayMode> **ON | 1**  
Turns on the marker table.

**OFF | 0**  
Turns off the marker table.

**AUTO**  
Turns on the marker table if 3 or more markers are active.

\*RST: AUTO

**Example:**

DISP:MTAB ON

Activates the marker table.

**Manual operation:**

See "[Marker Table Display](#)" on page 470

**DISPlay[:WINDow<n>]:MINFo[:STATe] <DisplayMode>**

This command turns the marker information in all diagrams on and off.

**Suffix:**

<n> irrelevant

**Parameters:**

<DisplayMode> **ON | 1**  
Displays the marker information in the diagrams.

**OFF | 0**

Hides the marker information in the diagrams.

\*RST: 1

**Example:**

DISP:MINF OFF

Hides the marker information.

**Manual operation:** See " [Marker Info](#) " on page 471

**CALCulate<n>:MARKer<m>:X:SSIZe <StepSize>**

This command selects the marker step size mode for *all* markers in *all* windows.

The step size defines the distance the marker moves when you move it with the rotary knob.

It therefore takes effect in manual operation only.

**Suffix:**

<n> irrelevant

<m> irrelevant

**Parameters:**

<StepSize> **STANdard**  
the marker moves from one pixel to the next

**POINTs**

the marker moves from one sweep point to the next

\*RST: POINTs

**Example:**

CALC:MARK:X:SSIZ STAN

Sets the marker step size to one pixel.

**Manual operation:** See " [Marker Stepsize](#) " on page 471

**9.8.8.3 Configuring and Performing a Marker Search**

The following commands control the marker search.

|                                               |     |
|-----------------------------------------------|-----|
| CALCulate<n>:MARKer<m>:LOEXclude.....         | 792 |
| CALCulate<n>:MARKer<m>:PEXCursion.....        | 792 |
| CALCulate<n>:MARKer<m>:X:SLIMits[:STATe]..... | 793 |
| CALCulate<n>:MARKer<m>:X:SLIMits:LEFT.....    | 793 |
| CALCulate<n>:MARKer<m>:X:SLIMits:RIGHT.....   | 794 |

CALCulate<n>:MARKer<m>:X:SLIMits:ZOOM[:STATe]..... 794  
 CALCulate<n>:THReshold..... 795  
 CALCulate<n>:THReshold:STATe..... 795

**CALCulate<n>:MARKer<m>:LOEXclude <State>**

This command turns the suppression of the local oscillator during automatic marker positioning on and off (for *all* markers in *all* windows).

**Suffix:**

<n> irrelevant  
 <m> irrelevant

**Parameters:**

<State> ON | OFF | 0 | 1  
 \*RST: 1

**Example:** CALC:MARK:LOEX ON

**Manual operation:** See " [Exclude LO](#) " on page 473

**CALCulate<n>:MARKer<m>:PEXCursion <Excursion>**

This command defines the peak excursion (for *all* markers in *all* windows).

The peak excursion sets the requirements for a peak to be detected during a peak search.

The unit depends on the measurement.

| Application/Result display | Unit |
|----------------------------|------|
| Spectrum                   | dB   |

**Suffix:**

<n> irrelevant  
 <m> irrelevant

**Parameters:**

<Excursion> The excursion is the distance to a trace maximum that must be attained before a new maximum is recognized, or the distance to a trace minimum that must be attained before a new minimum is recognized  
 \*RST: 6 dB in the Spectrum application and RF displays  
 Default unit: DB

**Example:** CALC:MARK:PEXC 10dB  
 Defines peak excursion as 10 dB.

**Manual operation:** See " [Peak Excursion](#) " on page 473



**CALCulate<n>:MARKer<m>:X:SLIMits[:STATe] <State>**

This command turns marker search limits on and off for *all* markers in *all* windows.

If you perform a measurement in the time domain, this command limits the range of the trace to be analyzed.

**Suffix:**

<n> irrelevant

<m> irrelevant

**Parameters:**

<State> ON | OFF | 0 | 1

**OFF | 0**

Switches the function off

**ON | 1**

Switches the function on

**Example:**

CALC:MARK:X:SLIM ON

Switches on search limitation.

**Manual operation:**

See " [Search Limits \( Left / Right \)](#) " on page 292

See " [Deactivating All Search Limits](#) " on page 292

See " [Limit State](#) " on page 364

**CALCulate<n>:MARKer<m>:X:SLIMits:LEFT <SearchLimit>**

This command defines the left limit of the marker search range for *all* markers in *all* windows.

If you perform a measurement in the time domain, this command limits the range of the trace to be analyzed.

**Suffix:**

<n> irrelevant

<m> irrelevant

**Parameters:**

<SearchLimit> The value range depends on the frequency range or sweep time.

The unit is Hz for frequency domain measurements and s for time domain measurements.

\*RST: left diagram border

Default unit: HZ

**Example:**

CALC:MARK:X:SLIM ON

Switches the search limit function on.

CALC:MARK:X:SLIM:LEFT 10MHZ

Sets the left limit of the search range to 10 MHz.

**Manual operation:**

See " [Search Limits \( Left / Right \)](#) " on page 292

See " [Left Limit / Right Limit](#) " on page 364

**CALCulate<n>:MARKer<m>:X:SLIMits:RIGHT <SearchLimit>**

This command defines the right limit of the marker search range for *all* markers in *all* windows.

If you perform a measurement in the time domain, this command limits the range of the trace to be analyzed.

**Suffix:**

<n> irrelevant

<m> irrelevant

**Parameters:**

<Limit> The value range depends on the frequency range or sweep time.

The unit is Hz for frequency domain measurements and s for time domain measurements.

\*RST: right diagram border

Default unit: HZ

**Example:**

```
CALC:MARK:X:SLIM ON
```

Switches the search limit function on.

```
CALC:MARK:X:SLIM:RIGH 20MHz
```

Sets the right limit of the search range to 20 MHz.

**Manual operation:** See "[Search Limits \( Left / Right \)](#)" on page 292  
See "[Left Limit / Right Limit](#)" on page 364

**CALCulate<n>:MARKer<m>:X:SLIMits:ZOOM[:STATe] <State>**

This command adjusts the marker search range to the zoom area for *all* markers in *all* windows.

**Suffix:**

<n> irrelevant

<m> irrelevant

**Parameters:**

<State> ON | OFF | 0 | 1

**OFF | 0**

Switches the function off

**ON | 1**

Switches the function on

**Example:**

```
CALC:MARK:X:SLIM:ZOOM ON
```

Switches the search limit function on.

```
CALC:MARK:X:SLIM:RIGH 20MHz
```

Sets the right limit of the search range to 20 MHz.

**Manual operation:** See "[Use Zoom Limits](#)" on page 474

**CALCulate<n>:THReshold <Level>**

This command defines a threshold level for the marker peak search (for *all* markers in *all* windows).

**Suffix:**

<n> irrelevant

**Parameters:**

<Level> Numeric value. The value range and unit are variable.

\*RST: -120 dBm

Default unit: DBM

**Example:**

CALC:THR -82DBM

Sets the threshold value to -82 dBm.

**Manual operation:** See "[Search Threshold](#)" on page 474

**CALCulate<n>:THReshold:STATe <State>**

This command turns a threshold for the marker peak search on and off (for *all* markers in *all* windows).

**Suffix:**

<n> irrelevant

**Parameters:**

<State> ON | OFF | 0 | 1

**OFF | 0**

Switches the function off

**ON | 1**

Switches the function on

**Example:**

CALC:THR:STAT ON

Switches on the threshold line.

**Manual operation:** See "[Deactivating All Search Limits](#)" on page 292

**9.8.8.4 Positioning the Marker**

This chapter contains remote commands necessary to position the marker on a trace.

- [Positioning Normal Markers](#) ..... 795
- [Positioning Delta Markers](#)..... 799

**Positioning Normal Markers**

The following commands position markers on the trace.

|                                                                         |     |
|-------------------------------------------------------------------------|-----|
| <a href="#">CALCulate&lt;n&gt;:MARKer&lt;m&gt;:MAXimum:AUTO</a> .....   | 796 |
| <a href="#">CALCulate&lt;n&gt;:MARKer&lt;m&gt;:MAXimum:LEFT</a> .....   | 796 |
| <a href="#">CALCulate&lt;n&gt;:MARKer&lt;m&gt;:MAXimum:NEXT</a> .....   | 796 |
| <a href="#">CALCulate&lt;n&gt;:MARKer&lt;m&gt;:MAXimum[:PEAK]</a> ..... | 797 |
| <a href="#">CALCulate&lt;n&gt;:MARKer&lt;m&gt;:MAXimum:RIGHT</a> .....  | 797 |

|                                            |     |
|--------------------------------------------|-----|
| CALCulate<n>:MARKer<m>:MINimum:AUTO.....   | 797 |
| CALCulate<n>:MARKer<m>:MINimum:LEFT.....   | 798 |
| CALCulate<n>:MARKer<m>:MINimum:NEXT.....   | 798 |
| CALCulate<n>:MARKer<m>:MINimum[:PEAK]..... | 798 |
| CALCulate<n>:MARKer<m>:MINimum:RIGHT.....  | 798 |

---

### CALCulate<n>:MARKer<m>:MAXimum:AUTO <State>

This command turns an automatic marker peak search for a trace maximum on and off. The R&S FPL1000 performs the peak search after each sweep.

#### Suffix:

|     |        |
|-----|--------|
| <n> | Window |
| <m> | Marker |

#### Parameters:

|         |                           |
|---------|---------------------------|
| <State> | ON   OFF   0   1          |
|         | <b>OFF   0</b>            |
|         | Switches the function off |
|         | <b>ON   1</b>             |
|         | Switches the function on  |

#### Example:

CALC:MARK:MAX:AUTO ON

Activates the automatic peak search function for marker 1 at the end of each particular sweep.

**Manual operation:** See " [Auto Max Peak Search / Auto Min Peak Search](#) " on page 473

---

### CALCulate<n>:MARKer<m>:MAXimum:LEFT

This command moves a marker to the next lower peak.

The search includes only measurement values to the left of the current marker position.

In the spectrogram, the command moves a marker horizontally to the maximum level in the currently selected frame. The vertical marker position remains the same.

#### Suffix:

|     |        |
|-----|--------|
| <n> | Window |
| <m> | Marker |

**Manual operation:** See " [Search Next Peak](#) " on page 478

---

### CALCulate<n>:MARKer<m>:MAXimum:NEXT

This command moves a marker to the next lower peak.

In the spectrogram, the command moves a marker horizontally to the maximum level in the currently selected frame. The vertical marker position remains the same.

**Suffix:**

&lt;n&gt;                    Window

&lt;m&gt;                    Marker

**Manual operation:**    See " [Search Next Peak](#) " on page 478**CALCulate<n>:MARKer<m>:MAXimum[:PEAK]**

This command moves a marker to the highest level.

In the spectrogram, the command moves a marker horizontally to the maximum level in the currently selected frame. The vertical marker position remains the same.

If the marker is not yet active, the command first activates the marker.

**Suffix:**

&lt;n&gt;                    Window

&lt;m&gt;                    Marker

**Manual operation:**    See " [Peak Search](#) " on page 478**CALCulate<n>:MARKer<m>:MAXimum:RIGHT**

This command moves a marker to the next lower peak.

The search includes only measurement values to the right of the current marker position.

In the spectrogram, the command moves a marker horizontally to the maximum level in the currently selected frame. The vertical marker position remains the same.

**Suffix:**

&lt;n&gt;                    Window

&lt;m&gt;                    Marker

**Manual operation:**    See " [Search Next Peak](#) " on page 478**CALCulate<n>:MARKer<m>:MINimum:AUTO <State>**

This command turns an automatic marker peak search for a trace minimum on and off. The R&S FPL1000 performs the peak search after each sweep.

**Suffix:**

&lt;n&gt;                    Window

&lt;m&gt;                    Marker

**Parameters:**

&lt;State&gt;                ON | OFF | 0 | 1

**OFF | 0**

Switches the function off

**ON | 1**

Switches the function on

**Example:** `CALC:MARK:MIN:AUTO ON`  
 Activates the automatic minimum value search function for marker 1 at the end of each particular sweep.

**Manual operation:** See " [Auto Max Peak Search / Auto Min Peak Search](#) " on page 473

#### **CALCulate<n>:MARKer<m>:MINimum:LEFT**

This command moves a marker to the next minimum value.

The search includes only measurement values to the right of the current marker position.

In the spectrogram, the command moves a marker horizontally to the minimum level in the currently selected frame. The vertical marker position remains the same.

**Suffix:**

<n> [Window](#)

<m> [Marker](#)

**Manual operation:** See " [Search Next Minimum](#) " on page 479

#### **CALCulate<n>:MARKer<m>:MINimum:NEXT**

This command moves a marker to the next minimum value.

In the spectrogram, the command moves a marker horizontally to the minimum level in the currently selected frame. The vertical marker position remains the same.

**Suffix:**

<n> [Window](#)

<m> [Marker](#)

**Manual operation:** See " [Search Next Minimum](#) " on page 479

#### **CALCulate<n>:MARKer<m>:MINimum[:PEAK]**

This command moves a marker to the minimum level.

In the spectrogram, the command moves a marker horizontally to the minimum level in the currently selected frame. The vertical marker position remains the same.

If the marker is not yet active, the command first activates the marker.

**Suffix:**

<n> [Window](#)

<m> [Marker](#)

**Manual operation:** See " [Search Minimum](#) " on page 479

#### **CALCulate<n>:MARKer<m>:MINimum:RIGHT**

This command moves a marker to the next minimum value.

The search includes only measurement values to the right of the current marker position.

In the spectrogram, the command moves a marker horizontally to the minimum level in the currently selected frame. The vertical marker position remains the same.

**Suffix:**

<n> Window

<m> Marker

**Manual operation:** See " [Search Next Minimum](#) " on page 479

**Positioning Delta Markers**

The following commands position delta markers on the trace.

|                                                 |     |
|-------------------------------------------------|-----|
| CALCulate<n>:DELTamarker<m>:MAXimum:LEFT.....   | 799 |
| CALCulate<n>:DELTamarker<m>:MAXimum:NEXT.....   | 799 |
| CALCulate<n>:DELTamarker<m>:MAXimum[:PEAK]..... | 800 |
| CALCulate<n>:DELTamarker<m>:MAXimum:RIGHT.....  | 800 |
| CALCulate<n>:DELTamarker<m>:MINimum:LEFT.....   | 800 |
| CALCulate<n>:DELTamarker<m>:MINimum:NEXT.....   | 800 |
| CALCulate<n>:DELTamarker<m>:MINimum[:PEAK]..... | 801 |
| CALCulate<n>:DELTamarker<m>:MINimum:RIGHT.....  | 801 |

---

**CALCulate<n>:DELTamarker<m>:MAXimum:LEFT**

This command moves a delta marker to the next higher value.

The search includes only measurement values to the left of the current marker position.

In the spectrogram, the command moves a marker horizontally to the maximum level in the currently selected frame. The vertical marker position remains the same.

**Suffix:**

<n> Window

<m> Marker

**Manual operation:** See " [Search Next Peak](#) " on page 478

---

**CALCulate<n>:DELTamarker<m>:MAXimum:NEXT**

This command moves a marker to the next higher value.

In the spectrogram, the command moves a marker horizontally to the maximum level in the currently selected frame. The vertical marker position remains the same.

**Suffix:**

<n> 1..n  
Window

<m> 1..n  
Marker

**Manual operation:** See " [Search Next Peak](#) " on page 478

---

**CALCulate<n>:DELTamarker<m>:MAXimum[:PEAK]**

This command moves a delta marker to the highest level.

In the spectrogram, the command moves a marker horizontally to the maximum level in the currently selected frame. The vertical marker position remains the same.

If the marker is not yet active, the command first activates the marker.

**Suffix:**

<n> [Window](#)

<m> [Marker](#)

**Manual operation:** See " [Peak Search](#) " on page 478

---

**CALCulate<n>:DELTamarker<m>:MAXimum:RIGHT**

This command moves a delta marker to the next higher value.

The search includes only measurement values to the right of the current marker position.

In the spectrogram, the command moves a marker horizontally to the maximum level in the currently selected frame. The vertical marker position remains the same.

**Suffix:**

<n> [Window](#)

<m> [Marker](#)

**Manual operation:** See " [Search Next Peak](#) " on page 478

---

**CALCulate<n>:DELTamarker<m>:MINimum:LEFT**

This command moves a delta marker to the next higher minimum value.

The search includes only measurement values to the right of the current marker position.

In the spectrogram, the command moves a marker horizontally to the minimum level in the currently selected frame. The vertical marker position remains the same.

**Suffix:**

<n> [Window](#)

<m> [Marker](#)

**Manual operation:** See " [Search Next Minimum](#) " on page 479

---

**CALCulate<n>:DELTamarker<m>:MINimum:NEXT**

This command moves a marker to the next higher minimum value.



In the spectrogram, the command moves a marker horizontally to the minimum level in the currently selected frame. The vertical marker position remains the same.

**Suffix:**

<n> [Window](#)

<m> [Marker](#)

**Manual operation:** See "[Search Next Minimum](#)" on page 479

**CALCulate<n>:DELTaMarker<m>:MINimum[:PEAK]**

This command moves a delta marker to the minimum level.

In the spectrogram, the command moves a marker horizontally to the minimum level in the currently selected frame. The vertical marker position remains the same.

If the marker is not yet active, the command first activates the marker.

**Suffix:**

<n> [Window](#)

<m> [Marker](#)

**Manual operation:** See "[Search Minimum](#)" on page 479

**CALCulate<n>:DELTaMarker<m>:MINimum:RIGHT**

This command moves a delta marker to the next higher minimum value.

The search includes only measurement values to the right of the current marker position.

In the spectrogram, the command moves a marker horizontally to the minimum level in the currently selected frame. The vertical marker position remains the same.

**Suffix:**

<n> [Window](#)

<m> [Marker](#)

**Manual operation:** See "[Search Next Minimum](#)" on page 479

**9.8.8.5 Retrieving Marker Results**

The following commands are used to retrieve the results of markers.



You can use the marker values to position the center frequency or reference level directly using the following commands:

- [CALCulate<n>:MARKer<m>:FUNction:CENTer](#) on page 712
- [CALCulate<n>:MARKer<m>:FUNction:REFerence](#) on page 729

Useful commands for retrieving results described elsewhere:

- [CALCulate<n>:DELTaMarker<m>:X](#) on page 787

- `CALCulate<n>:MARKer<m>:X` on page 789
- `CALCulate<n>:MARKer<m>:FUNCTION:FPEaks:COUNT?` on page 815
- `CALCulate<n>:MARKer<m>:FUNCTION:FPEaks:X?` on page 817
- `CALCulate<n>:MARKer<m>:FUNCTION:FPEaks:Y?` on page 817
- `CALCulate<n>:MARKer<m>:FUNCTION:NOISE:RESult?` on page 818
- `CALCulate<n>:DELTamarker<m>:FUNCTION:PNOise:RESult?` on page 820
- `CALCulate<n>:DELTamarker<m>:FUNCTION:BPOwer:RESult?` on page 825
- `CALCulate<n>:MARKer<m>:FUNCTION:BPOwer:RESult?` on page 823
- `CALCulate<n>:MARKer<m>:FUNCTION:NDBDown:RESult?` on page 828
- `CALCulate<n>:MARKer<m>:FUNCTION:NDBDown:FREQuency?` on page 827
- `CALCulate<n>:MARKer<m>:FUNCTION:NDBDown:QFACTOR?` on page 828
- `CALCulate<n>:MARKer<m>:COUNT:FREQuency?` on page 830

#### Remote commands exclusive to retrieving marker results

|                                                                        |     |
|------------------------------------------------------------------------|-----|
| <code>CALCulate&lt;n&gt;:DELTamarker&lt;m&gt;:X:RELative?</code> ..... | 802 |
| <code>CALCulate&lt;n&gt;:DELTamarker&lt;m&gt;:Y</code> .....           | 802 |
| <code>CALCulate&lt;n&gt;:MARKer&lt;m&gt;:Y</code> .....                | 803 |

---

#### `CALCulate<n>:DELTamarker<m>:X:RELative?`

This command queries the relative position of a delta marker on the x-axis.

If necessary, the command activates the delta marker first.

##### Suffix:

<n>                      Window

<m>                      Marker

##### Return values:

<Position>              Position of the delta marker in relation to the reference marker.

##### Example:

`CALC:DELT3:X:REL?`

Outputs the frequency of delta marker 3 relative to marker 1 or relative to the reference position.

##### Usage:

Query only

##### Manual operation:

See " [Marker 1 / Marker 2 / Marker 3 / Marker 4](#) " on page 378  
See " [Marker 1 / Marker 2 / Marker 3](#) " on page 383

---

#### `CALCulate<n>:DELTamarker<m>:Y`

##### Suffix:

<n>                      1..n

<m>                      1..n

**Return values:**

<Result> Result at the position of the delta marker.  
The unit is variable and depends on the one you have currently set.  
Default unit: DBM

**CALCulate<n>:MARKer<m>:Y****Suffix:**

<n> 1..n  
<m> 1..n

**Return values:**

<Result> Default unit: DBM

**Manual operation:** See " [Marker Table](#) " on page 260  
See " [Marker Peak List](#) " on page 261

**9.8.8.6 Marker Search (Spectrograms)**

The following commands automatically define the marker and delta marker position in the spectrogram.



The usage of these markers is demonstrated in [Chapter 9.8.7.7, "Programming Example: Configuring a Spectrogram"](#), on page 781.

**Using Markers**

The following commands control spectrogram markers.

**Useful commands for spectrogram markers described elsewhere**

The following commands define the horizontal position of the markers.

- [CALCulate<n>:MARKer<m>:MAXimum:LEFT](#) on page 796
- [CALCulate<n>:MARKer<m>:MAXimum:NEXT](#) on page 796
- [CALCulate<n>:MARKer<m>:MAXimum\[:PEAK\]](#) on page 797
- [CALCulate<n>:MARKer<m>:MAXimum:RIGHT](#) on page 797
- [CALCulate<n>:MARKer<m>:MINimum:LEFT](#) on page 798
- [CALCulate<n>:MARKer<m>:MINimum:NEXT](#) on page 798
- [CALCulate<n>:MARKer<m>:MINimum\[:PEAK\]](#) on page 798
- [CALCulate<n>:MARKer<m>:MINimum:RIGHT](#) on page 798

**Remote commands exclusive to spectrogram markers**

|                                                                            |     |
|----------------------------------------------------------------------------|-----|
| <a href="#">CALCulate&lt;n&gt;:MARKer&lt;m&gt;:SGRam:FRAME</a> .....       | 804 |
| <a href="#">CALCulate&lt;n&gt;:MARKer&lt;m&gt;:SPEctrogram:FRAME</a> ..... | 804 |
| <a href="#">CALCulate&lt;n&gt;:MARKer&lt;m&gt;:SGRam:SARea</a> .....       | 805 |

|                                                           |     |
|-----------------------------------------------------------|-----|
| CALCulate<n>:MARKer<m>:SPECtrogram:SARea.....             | 805 |
| CALCulate<n>:MARKer<m>:SGRam:XY:MAXimum[:PEAK].....       | 805 |
| CALCulate<n>:MARKer<m>:SPECtrogram:XY:MAXimum[:PEAK]..... | 805 |
| CALCulate<n>:MARKer<m>:SGRam:XY:MINimum[:PEAK].....       | 805 |
| CALCulate<n>:MARKer<m>:SPECtrogram:XY:MINimum[:PEAK]..... | 805 |
| CALCulate<n>:MARKer<m>:SGRam:Y:MAXimum:ABOVE.....         | 805 |
| CALCulate<n>:MARKer<m>:SPECtrogram:Y:MAXimum:ABOVE.....   | 805 |
| CALCulate<n>:MARKer<m>:SGRam:Y:MAXimum:BELOW.....         | 806 |
| CALCulate<n>:MARKer<m>:SPECtrogram:Y:MAXimum:BELOW.....   | 806 |
| CALCulate<n>:MARKer<m>:SGRam:Y:MAXimum:NEXT.....          | 806 |
| CALCulate<n>:MARKer<m>:SPECtrogram:Y:MAXimum:NEXT.....    | 806 |
| CALCulate<n>:MARKer<m>:SGRam:Y:MAXimum[:PEAK].....        | 806 |
| CALCulate<n>:MARKer<m>:SPECtrogram:Y:MAXimum[:PEAK].....  | 806 |
| CALCulate<n>:MARKer<m>:SGRam:Y:MINimum:ABOVE.....         | 806 |
| CALCulate<n>:MARKer<m>:SPECtrogram:Y:MINimum:ABOVE.....   | 806 |
| CALCulate<n>:MARKer<m>:SGRam:Y:MINimum:BELOW.....         | 807 |
| CALCulate<n>:MARKer<m>:SPECtrogram:Y:MINimum:BELOW.....   | 807 |
| CALCulate<n>:MARKer<m>:SGRam:Y:MINimum:NEXT.....          | 807 |
| CALCulate<n>:MARKer<m>:SPECtrogram:Y:MINimum:NEXT.....    | 807 |
| CALCulate<n>:MARKer<m>:SGRam:Y:MINimum[:PEAK].....        | 807 |
| CALCulate<n>:MARKer<m>:SPECtrogram:Y:MINimum[:PEAK].....  | 807 |

---

**CALCulate<n>:MARKer<m>:SGRam:FRAME <Frame>**

**CALCulate<n>:MARKer<m>:SPECtrogram:FRAME <Frame> | <Time>**

This command positions a marker on a particular frame.

**Suffix:**

<n>                      Window

<m>                      Marker

**Parameters:**

<Frame>                Selects a frame directly by the frame number. Valid if the time stamp is off.

The range depends on the history depth.

Default unit: S

<Time>                Selects a frame via its time stamp. Valid if the time stamp is on.

The number is the (negative) distance to frame 0 in seconds.

The range depends on the history depth.

**Example:**

CALC:MARK:SGR:FRAM -20

Sets the marker on the 20th frame before the present.

CALC:MARK2:SGR:FRAM -2s

Sets second marker on the frame 2 seconds ago.

**Manual operation:** See " [Frame \(Spectrogram only\)](#)" on page 468

---

**CALCulate<n>:MARKer<m>:SGRam:SARea <SearchArea>**

**CALCulate<n>:MARKer<m>:SPECTrogram:SARea <SearchArea>**

This command defines the marker search area for all spectrogram markers in the channel setup.

**Suffix:**

<n> irrelevant

<m> irrelevant

**Parameters:**

<SearchArea>

**VISible**

Performs a search within the visible frames.

Note that the command does not work if the spectrogram is not visible for any reason (e.g. if the display update is off).

**MEMory**

Performs a search within all frames in the memory.

\*RST: VISible

**Manual operation:** See "[Marker Search Area](#)" on page 476

---

**CALCulate<n>:MARKer<m>:SGRam:XY:MAXimum[:PEAK]**

**CALCulate<n>:MARKer<m>:SPECTrogram:XY:MAXimum[:PEAK]**

This command moves a marker to the highest level of the spectrogram.

**Suffix:**

<n> [Window](#)

<m> [Marker](#)

---

**CALCulate<n>:MARKer<m>:SGRam:XY:MINimum[:PEAK]**

**CALCulate<n>:MARKer<m>:SPECTrogram:XY:MINimum[:PEAK]**

This command moves a marker to the minimum level of the spectrogram.

**Suffix:**

<n> [Window](#)

<m> [Marker](#)

---

**CALCulate<n>:MARKer<m>:SGRam:Y:MAXimum:ABOVE**

**CALCulate<n>:MARKer<m>:SPECTrogram:Y:MAXimum:ABOVE**

This command moves a marker vertically to the next lower peak level for the current frequency.

The search includes only frames above the current marker position. It does not change the horizontal position of the marker.

**Suffix:**

<n> [Window](#)

<m> [Marker](#)

**Manual operation:** See " [Search Mode for Next Peak in Y-Direction](#) " on page 475

---

**CALCulate<n>:MARKer<m>:SGRam:Y:MAXimum:BELOW**  
**CALCulate<n>:MARKer<m>:SPECTrogram:Y:MAXimum:BELOW**

This command moves a marker vertically to the next lower peak level for the current frequency.

The search includes only frames below the current marker position. It does not change the horizontal position of the marker.

**Suffix:**

<n> [Window](#)

<m> [Marker](#)

**Manual operation:** See " [Search Mode for Next Peak in Y-Direction](#) " on page 475

---

**CALCulate<n>:MARKer<m>:SGRam:Y:MAXimum:NEXT**  
**CALCulate<n>:MARKer<m>:SPECTrogram:Y:MAXimum:NEXT**

This command moves a marker vertically to the next lower peak level for the current frequency.

The search includes all frames. It does not change the horizontal position of the marker.

**Suffix:**

<n> [Window](#)

<m> [Marker](#)

**Manual operation:** See " [Search Mode for Next Peak in Y-Direction](#) " on page 475

---

**CALCulate<n>:MARKer<m>:SGRam:Y:MAXimum[:PEAK]**  
**CALCulate<n>:MARKer<m>:SPECTrogram:Y:MAXimum[:PEAK]**

This command moves a marker vertically to the highest level for the current frequency.

The search includes all frames. It does not change the horizontal position of the marker.

If the marker hasn't been active yet, the command looks for the peak level in the whole spectrogram.

**Suffix:**

<n> [Window](#)

<m> [Marker](#)

---

**CALCulate<n>:MARKer<m>:SGRam:Y:MINimum:ABOVE**  
**CALCulate<n>:MARKer<m>:SPECTrogram:Y:MINimum:ABOVE**

This command moves a marker vertically to the next higher minimum level for the current frequency.

The search includes only frames above the current marker position. It does not change the horizontal position of the marker.

**Suffix:**

<n> [Window](#)

<m> [Marker](#)

**Manual operation:** See "[Search Mode for Next Peak in Y-Direction](#)" on page 475

**CALCulate<n>:MARKer<m>:SGRam:Y:MINimum:BELOW**

**CALCulate<n>:MARKer<m>:SPECTrogram:Y:MINimum:BELOW**

This command moves a marker vertically to the next higher minimum level for the current frequency.

The search includes only frames below the current marker position. It does not change the horizontal position of the marker.

**Suffix:**

<n> [Window](#)

<m> [Marker](#)

**Manual operation:** See "[Search Mode for Next Peak in Y-Direction](#)" on page 475

**CALCulate<n>:MARKer<m>:SGRam:Y:MINimum:NEXT**

**CALCulate<n>:MARKer<m>:SPECTrogram:Y:MINimum:NEXT**

This command moves a marker vertically to the next higher minimum level for the current frequency.

The search includes all frames. It does not change the horizontal position of the marker.

**Suffix:**

<n> [Window](#)

<m> [Marker](#)

**Manual operation:** See "[Search Mode for Next Peak in Y-Direction](#)" on page 475

**CALCulate<n>:MARKer<m>:SGRam:Y:MINimum[:PEAK]**

**CALCulate<n>:MARKer<m>:SPECTrogram:Y:MINimum[:PEAK]**

This command moves a marker vertically to the minimum level for the current frequency.

The search includes all frames. It does not change the horizontal position of the marker.

If the marker hasn't been active yet, the command first looks for the peak level for all frequencies and moves the marker vertically to the minimum level.

**Suffix:**

<n> [Window](#)

<m>                      Marker

### Using Delta Markers

The following commands control spectrogram delta markers.

#### Useful commands for spectrogram markers described elsewhere

The following commands define the horizontal position of the delta markers.

- `CALCulate<n>:DELTamarker<m>:MAXimum:LEFT` on page 799
- `CALCulate<n>:DELTamarker<m>:MAXimum:NEXT` on page 799
- `CALCulate<n>:DELTamarker<m>:MAXimum[:PEAK]` on page 800
- `CALCulate<n>:DELTamarker<m>:MAXimum:RIGHT` on page 800
- `CALCulate<n>:DELTamarker<m>:MINimum:LEFT` on page 800
- `CALCulate<n>:DELTamarker<m>:MINimum:NEXT` on page 800
- `CALCulate<n>:DELTamarker<m>:MINimum[:PEAK]` on page 801
- `CALCulate<n>:DELTamarker<m>:MINimum:RIGHT` on page 801

#### Remote commands exclusive to spectrogram markers

|                                                                                          |     |
|------------------------------------------------------------------------------------------|-----|
| <code>CALCulate&lt;n&gt;:DELTamarker&lt;m&gt;:SGRam:FRAMe</code> .....                   | 809 |
| <code>CALCulate&lt;n&gt;:DELTamarker&lt;m&gt;:SPECTrogram:FRAMe</code> .....             | 809 |
| <code>CALCulate&lt;n&gt;:DELTamarker&lt;m&gt;:SGRam:SARea</code> .....                   | 809 |
| <code>CALCulate&lt;n&gt;:DELTamarker&lt;m&gt;:SPECTrogram:SARea</code> .....             | 809 |
| <code>CALCulate&lt;n&gt;:DELTamarker&lt;m&gt;:SGRam:XY:MAXimum[:PEAK]</code> .....       | 810 |
| <code>CALCulate&lt;n&gt;:DELTamarker&lt;m&gt;:SPECTrogram:XY:MAXimum[:PEAK]</code> ..... | 810 |
| <code>CALCulate&lt;n&gt;:DELTamarker&lt;m&gt;:SGRam:XY:MINimum[:PEAK]</code> .....       | 810 |
| <code>CALCulate&lt;n&gt;:DELTamarker&lt;m&gt;:SPECTrogram:XY:MINimum[:PEAK]</code> ..... | 810 |
| <code>CALCulate&lt;n&gt;:DELTamarker&lt;m&gt;:SGRam:Y:MAXimum:ABOVe</code> .....         | 810 |
| <code>CALCulate&lt;n&gt;:DELTamarker&lt;m&gt;:SPECTrogram:Y:MAXimum:ABOVe</code> .....   | 810 |
| <code>CALCulate&lt;n&gt;:DELTamarker&lt;m&gt;:SGRam:Y:MAXimum:BELow</code> .....         | 810 |
| <code>CALCulate&lt;n&gt;:DELTamarker&lt;m&gt;:SPECTrogram:Y:MAXimum:BELow</code> .....   | 810 |
| <code>CALCulate&lt;n&gt;:DELTamarker&lt;m&gt;:SGRam:Y:MAXimum:NEXT</code> .....          | 811 |
| <code>CALCulate&lt;n&gt;:DELTamarker&lt;m&gt;:SPECTrogram:Y:MAXimum:NEXT</code> .....    | 811 |
| <code>CALCulate&lt;n&gt;:DELTamarker&lt;m&gt;:SGRam:Y:MAXimum[:PEAK]</code> .....        | 811 |
| <code>CALCulate&lt;n&gt;:DELTamarker&lt;m&gt;:SPECTrogram:Y:MAXimum[:PEAK]</code> .....  | 811 |
| <code>CALCulate&lt;n&gt;:DELTamarker&lt;m&gt;:SGRam:Y:MINimum:ABOVe</code> .....         | 811 |
| <code>CALCulate&lt;n&gt;:DELTamarker&lt;m&gt;:SPECTrogram:Y:MINimum:ABOVe</code> .....   | 811 |
| <code>CALCulate&lt;n&gt;:DELTamarker&lt;m&gt;:SGRam:Y:MINimum:BELow</code> .....         | 811 |
| <code>CALCulate&lt;n&gt;:DELTamarker&lt;m&gt;:SPECTrogram:Y:MINimum:BELow</code> .....   | 811 |
| <code>CALCulate&lt;n&gt;:DELTamarker&lt;m&gt;:SGRam:Y:MINimum:NEXT</code> .....          | 812 |
| <code>CALCulate&lt;n&gt;:DELTamarker&lt;m&gt;:SPECTrogram:Y:MINimum:NEXT</code> .....    | 812 |
| <code>CALCulate&lt;n&gt;:DELTamarker&lt;m&gt;:SGRam:Y:MINimum[:PEAK]</code> .....        | 812 |
| <code>CALCulate&lt;n&gt;:DELTamarker&lt;m&gt;:SPECTrogram:Y:MINimum[:PEAK]</code> .....  | 812 |



---

**CALCulate<n>:DELTaMarker<m>:SGRam:FRAMe <Frame>**

**CALCulate<n>:DELTaMarker<m>:SPECTrogram:FRAMe <Frame>**

This command positions a delta marker on a particular frame. The frame is relative to the position of marker 1.

The command is available for the spectrogram.

**Suffix:**

<n> [Window](#)

<m> [Marker](#)

**Parameters:**

<Frame> Selects a frame either by its frame number or time stamp. The frame number is available if the time stamp is off. The range depends on the history depth.

The time stamp is available if the time stamp is on. The number is the distance to frame 0 in seconds. The range depends on the history depth.

Default unit: S

**Example:**

`CALC:DELT4:SGR:FRAM -20`

Sets fourth deltamarker 20 frames below marker 1.

`CALC:DELT4:SGR:FRAM 2 s`

Sets fourth deltamarker 2 seconds above the position of marker 1.

**Manual operation:** See "[Frame \(Spectrogram only\)](#)" on page 468

---

**CALCulate<n>:DELTaMarker<m>:SGRam:SARea <SearchArea>**

**CALCulate<n>:DELTaMarker<m>:SPECTrogram:SARea <SearchArea>**

This command defines the marker search area for *all* spectrogram markers in the channel setup.

**Suffix:**

<n> irrelevant

<m> irrelevant

**Parameters:**

<SearchArea>

**VISible**

Performs a search within the visible frames.

Note that the command does not work if the spectrogram is not visible for any reason (e.g. if the display update is off).

**MEMory**

Performs a search within all frames in the memory.

\*RST: [VISible](#)

**Manual operation:** See "[Marker Search Area](#)" on page 476

---

**CALCulate<n>:DELTaMarker<m>:SGRam:XY:MAXimum[:PEAK]**  
**CALCulate<n>:DELTaMarker<m>:SPECTrogram:XY:MAXimum[:PEAK]**

This command moves a marker to the highest level of the spectrogram over all frequencies.

**Suffix:**

<n> [Window](#)

<m> [Marker](#)

---

**CALCulate<n>:DELTaMarker<m>:SGRam:XY:MINimum[:PEAK]**  
**CALCulate<n>:DELTaMarker<m>:SPECTrogram:XY:MINimum[:PEAK]**

This command moves a delta marker to the minimum level of the spectrogram over all frequencies.

**Suffix:**

<n> [Window](#)

<m> [Marker](#)

---

**CALCulate<n>:DELTaMarker<m>:SGRam:Y:MAXimum:ABOVE**  
**CALCulate<n>:DELTaMarker<m>:SPECTrogram:Y:MAXimum:ABOVE**

This command moves a marker vertically to the next higher level for the current frequency.

The search includes only frames above the current marker position. It does not change the horizontal position of the marker.

**Suffix:**

<n> [Window](#)

<m> [Marker](#)

**Manual operation:** See "[Search Mode for Next Peak in Y-Direction](#)" on page 475

---

**CALCulate<n>:DELTaMarker<m>:SGRam:Y:MAXimum:BELOW**  
**CALCulate<n>:DELTaMarker<m>:SPECTrogram:Y:MAXimum:BELOW**

This command moves a marker vertically to the next higher level for the current frequency.

The search includes only frames below the current marker position. It does not change the horizontal position of the marker.

**Suffix:**

<n> [Window](#)

<m> [Marker](#)

**Manual operation:** See "[Search Mode for Next Peak in Y-Direction](#)" on page 475

---

**CALCulate<n>:DELTaMarker<m>:SGRam:Y:MAXimum:NEXT**
**CALCulate<n>:DELTaMarker<m>:SPECTrogram:Y:MAXimum:NEXT**

This command moves a delta marker vertically to the next higher level for the current frequency.

The search includes all frames. It does not change the horizontal position of the marker.

**Suffix:**

<n>                      [Window](#)

<m>                      [Marker](#)

**Manual operation:**    See "[Search Mode for Next Peak in Y-Direction](#)" on page 475

---

**CALCulate<n>:DELTaMarker<m>:SGRam:Y:MAXimum[:PEAK]**
**CALCulate<n>:DELTaMarker<m>:SPECTrogram:Y:MAXimum[:PEAK]**

This command moves a delta marker vertically to the highest level for the current frequency.

The search includes all frames. It does not change the horizontal position of the marker.

If the marker hasn't been active yet, the command looks for the peak level in the whole spectrogram.

**Suffix:**

<n>                      [Window](#)

<m>                      [Marker](#)

---

**CALCulate<n>:DELTaMarker<m>:SGRam:Y:MINimum:ABOVE**
**CALCulate<n>:DELTaMarker<m>:SPECTrogram:Y:MINimum:ABOVE**

This command moves a delta marker vertically to the next minimum level for the current frequency.

The search includes only frames above the current marker position. It does not change the horizontal position of the marker.

**Suffix:**

<n>                      [Window](#)

<m>                      [Marker](#)

**Manual operation:**    See "[Search Mode for Next Peak in Y-Direction](#)" on page 475

---

**CALCulate<n>:DELTaMarker<m>:SGRam:Y:MINimum:BELOW**
**CALCulate<n>:DELTaMarker<m>:SPECTrogram:Y:MINimum:BELOW**

This command moves a delta marker vertically to the next minimum level for the current frequency.

The search includes only frames below the current marker position. It does not change the horizontal position of the marker.

**Suffix:**

&lt;n&gt; Window

&lt;m&gt; Marker

**Manual operation:** See " [Search Mode for Next Peak in Y-Direction](#) " on page 475**CALCulate<n>:DELTamarker<m>:SGRam:Y:MINimum:NEXT****CALCulate<n>:DELTamarker<m>:SPECTrogram:Y:MINimum:NEXT**

This command moves a delta marker vertically to the next minimum level for the current frequency.

The search includes all frames. It does not change the horizontal position of the marker.

**Suffix:**

&lt;n&gt; Window

&lt;m&gt; Marker

**Manual operation:** See " [Search Mode for Next Peak in Y-Direction](#) " on page 475**CALCulate<n>:DELTamarker<m>:SGRam:Y:MINimum[:PEAK]****CALCulate<n>:DELTamarker<m>:SPECTrogram:Y:MINimum[:PEAK]**

This command moves a delta marker vertically to the minimum level for the current frequency.

The search includes all frames. It does not change the horizontal position of the marker.

If the marker hasn't been active yet, the command first looks for the peak level in the whole spectrogram and moves the marker vertically to the minimum level.

**Suffix:**

&lt;n&gt; Window

&lt;m&gt; Marker

**9.8.8.7 Fixed Reference Marker Settings**

The following commands configure a fixed reference marker.

|                                                                                                    |     |
|----------------------------------------------------------------------------------------------------|-----|
| <a href="#">CALCulate&lt;n&gt;:DELTamarker&lt;m&gt;:FUNCTION:FIXed:RPOint:MAXimum[:PEAK]</a> ..... | 812 |
| <a href="#">CALCulate&lt;n&gt;:DELTamarker&lt;m&gt;:FUNCTION:FIXed:RPOint:X</a> .....              | 813 |
| <a href="#">CALCulate&lt;n&gt;:DELTamarker&lt;m&gt;:FUNCTION:FIXed:RPOint:Y</a> .....              | 813 |
| <a href="#">CALCulate&lt;n&gt;:DELTamarker&lt;m&gt;:FUNCTION:FIXed:RPOint:Y:OFFSet</a> .....       | 814 |
| <a href="#">CALCulate&lt;n&gt;:DELTamarker&lt;m&gt;:FUNCTION:FIXed[:STATE]</a> .....               | 814 |

**CALCulate<n>:DELTamarker<m>:FUNCTION:FIXed:RPOint:MAXimum[:PEAK]**

This command moves the fixed reference marker to the peak power.

**Suffix:**

&lt;n&gt; Window

<m> [Marker](#)

**Example:** `CALC:DELT:FUNC:FIX:RPO:MAX`  
Sets the reference point level for delta markers to the peak of the selected trace.

**Manual operation:** See ["Defining a Fixed Reference"](#) on page 471  
See ["Defining Reference Point"](#) on page 487

#### **CALCulate<n>:DELTaMarker<m>:FUNctioN:FIXed:RPOint:X <RefPoint>**

This command defines the horizontal position of the fixed delta marker reference point. The coordinates of the reference may be anywhere in the diagram.

**Suffix:**

<n> [Window](#)

<m> [Marker](#)

**Parameters:**

<RefPoint> Numeric value that defines the horizontal position of the reference.  
For frequency domain measurements, it is a frequency in Hz.  
For time domain measurements, it is a point in time in s.  
**\*RST:** Fixed Reference: OFF  
Default unit: HZ

**Example:** `CALC:DELT:FUNC:FIX:RPO:X 128 MHz`  
Sets the frequency reference to 128 MHz.

**Manual operation:** See ["Defining a Fixed Reference"](#) on page 471  
See ["Defining Reference Point"](#) on page 487

#### **CALCulate<n>:DELTaMarker<m>:FUNctioN:FIXed:RPOint:Y <RefPointLevel>**

This command defines the vertical position of the fixed delta marker reference point. The coordinates of the reference may be anywhere in the diagram.

**Suffix:**

<n> [Window](#)

<m> [Marker](#)

**Parameters:**

<RefPoint> Numeric value that defines the vertical position of the reference.  
The unit and value range is variable.  
**\*RST:** Fixed Reference: OFF  
Default unit: DBM

**Example:** `CALC:DELT:FUNC:FIX:RPO:Y -10dBm`  
Sets the reference point level for delta markers to -10 dBm.

**Manual operation:** See ["Defining a Fixed Reference"](#) on page 471  
See ["Defining Reference Point"](#) on page 487

**CALCulate<n>:DELTamarker<m>:FUNction:FIXed:RPOint:Y:OFFSet <Offset>**

This command defines a level offset for the fixed delta marker reference point.

**Suffix:**

<n> [Window](#)

<m> [Marker](#)

**Parameters:**

<Offset> Numeric value  
 \*RST: 0  
 Default unit: dB

**CALCulate<n>:DELTamarker<m>:FUNction:FIXed[:STATe] <State>**

This command activates or deactivates a marker that defines a fixed reference point for relative marker analysis.

If necessary, the command activates a marker and positions it on the peak power.

Subsequently, you can change the coordinates of the fixed reference independent of the marker. The fixed reference is independent of the trace and is applied to all active delta markers.

**Suffix:**

<n> [Window](#)

<m> [Marker](#)

**Parameters:**

<State> ON | OFF | 0 | 1  
**OFF | 0**  
 Switches the function off  
**ON | 1**  
 Switches the function on

**Example:**

```
CALC:DELT:FUNC:FIX ON
Switches on the measurement with fixed reference value for all
delta markers.
CALC:DELT:FUNC:FIX:RPO:X 128 MHZ
Sets the frequency reference to 128 MHz.
CALC:DELT:FUNC:FIX:RPO:Y 30 DBM
Sets the reference level to +30 dBm.
```

**Manual operation:** See "[Defining a Fixed Reference](#)" on page 471

**9.8.8.8 Marker Peak Lists****Useful commands for peak lists described elsewhere**

- [CALCulate<n>:MARKer<m>:PEXCursion](#) on page 792
- [MMEMemory:STORe<n>:PEAK](#) on page 887

- [Chapter 9.8.8.3, "Configuring and Performing a Marker Search"](#), on page 791

### Remote commands exclusive to peak lists

|                                                                      |     |
|----------------------------------------------------------------------|-----|
| CALCulate<n>:MARKer<m>:FUNcTion:FPEaks:ANNotation:LABel[:STATe]..... | 815 |
| CALCulate<n>:MARKer<m>:FUNcTion:FPEaks:COUNt?.....                   | 815 |
| CALCulate<n>:MARKer<m>:FUNcTion:FPEaks:IMMediate].....               | 816 |
| CALCulate<n>:MARKer<m>:FUNcTion:FPEaks:LIST:SIZE.....                | 816 |
| CALCulate<n>:MARKer<m>:FUNcTion:FPEaks:SORT.....                     | 816 |
| CALCulate<n>:MARKer<m>:FUNcTion:FPEaks:STATe.....                    | 817 |
| CALCulate<n>:MARKer<m>:FUNcTion:FPEaks:X?.....                       | 817 |
| CALCulate<n>:MARKer<m>:FUNcTion:FPEaks:Y?.....                       | 817 |

---

#### CALCulate<n>:MARKer<m>:FUNcTion:FPEaks:ANNotation:LABel[:STATe] <State>

This command turns labels for peaks found during a peak search on and off.

The labels correspond to the marker number in the marker peak list.

#### Suffix:

<n>                      Window

<m>                      Marker

#### Parameters:

<State>                ON | OFF | 0 | 1

\*RST:                1

#### Example:

CALC:MARK:FUNC:FPE:ANN:LAB:STAT OFF

Removes the peak labels from the diagram

**Manual operation:** See "[Display Marker Numbers](#)" on page 499

---

#### CALCulate<n>:MARKer<m>:FUNcTion:FPEaks:COUNt?

This command queries the number of peaks that have been found during a peak search.

The actual number of peaks that have been found may differ from the number of peaks you have set to be found because of the peak excursion.

#### Suffix:

<n>                      irrelevant

<m>                      irrelevant

#### Return values:

<NumberOfPeaks>

#### Example:

CALC:MARK:FUNC:FPE:COUN?

Queries the number of peaks.

#### Usage:

Query only

**CALCulate<n>:MARKer<m>:FUNCtion:FPEaks[:IMMediate] <Peaks>**

This command initiates a peak search.

**Suffix:**

<n> [Window](#)

<m> [Marker](#)

**Parameters:**

<Peaks> This parameter defines the number of peaks to find during the search.

Note that the actual number of peaks found during the search also depends on the peak excursion you have set with [CALCulate<n>:MARKer<m>:PEXCursion](#).

Range: 1 to 200

**Example:**

`CALC:MARK:PEXC 5`

Defines a peak excursion of 5 dB, i.e. peaks must be at least 5 dB apart to be detected as a peak.

`CALC:MARK:FUNC:FPE 10`

Initiates a search for 10 peaks on the current trace.

**CALCulate<n>:MARKer<m>:FUNCtion:FPEaks:LIST:SIZE <MaxNoPeaks>**

This command defines the maximum number of peaks that the R&S FPL1000 looks for during a peak search.

**Suffix:**

<n> [Window](#)

<m> [Marker](#)

**Parameters:**

<MaxNoPeaks> Maximum number of peaks to be determined.

Range: 1 to 200

\*RST: 50

**Example:**

`CALC:MARK:FUNC:FPE:LIST:SIZE 10`

The marker peak list will contain a maximum of 10 peaks.

**Manual operation:** See "[Maximum Number of Peaks](#)" on page 499

**CALCulate<n>:MARKer<m>:FUNCtion:FPEaks:SORT <SortMode>**

This command selects the order in which the results of a peak search are returned.

**Suffix:**

<n> [Window](#)

<m> [Marker](#)

**Parameters:**

<SortMode> **X**

Sorts the peaks according to increasing position on the x-axis.



**Y**

Sorts the peaks according to decreasing position on the y-axis.

\*RST: X

**Example:**

CALC:MARK:FUNC:FPE:SORT Y

Sets the sort mode to decreasing y values

**Manual operation:** See " [Sort Mode](#) " on page 498

**CALCulate<n>:MARKer<m>:FUNction:FPEaks:STATe <State>**

This command turns a peak search on and off.

**Suffix:**

<n> [Window](#)

<m> [Marker](#)

**Parameters:**

<State> ON | OFF | 0 | 1

**OFF | 0**

Switches the function off

**ON | 1**

Switches the function on

**Example:**

CALC:MARK:FUNC:FPE:STAT ON

Activates marker peak search

**Manual operation:** See " [Peak List State](#) " on page 498

**CALCulate<n>:MARKer<m>:FUNction:FPEaks:X?**

This command queries the position of the peaks on the x-axis.

The order depends on the sort order that has been set with [CALCulate<n>:MARKer<m>:FUNction:FPEaks:STATe](#) and [CALCulate<n>:MARKer<m>:FUNction:FPEaks:STATe](#).

**Suffix:**

<n> irrelevant

<m> irrelevant

**Return values:**

<PeakPosition> Position of the peaks on the x-axis. The unit depends on the measurement.

**Usage:** Query only

**CALCulate<n>:MARKer<m>:FUNction:FPEaks:Y?**

This command queries the position of the peaks on the y-axis.

The order depends on the sort order that has been set with [CALCulate<n>:MARKer<m>:FUNction:FPEaks:STATe](#) and [CALCulate<n>:MARKer<m>:FUNction:FPEaks:STATe](#).

**Suffix:**

&lt;n&gt; irrelevant

&lt;m&gt; irrelevant

**Return values:**

&lt;PeakPosition&gt; Position of the peaks on the y-axis. The unit depends on the measurement.

**Usage:** Query only**9.8.8.9 Noise Measurement Marker**

The following commands control the noise measurement marker function.

|                                                    |     |
|----------------------------------------------------|-----|
| CALCulate<n>:MARKer<m>:FUNction:NOISe:AOff.....    | 818 |
| CALCulate<n>:MARKer<m>:FUNction:NOISe:RESult?..... | 818 |
| CALCulate<n>:MARKer<m>:FUNction:NOISe[:STATe]..... | 819 |

**CALCulate<n>:MARKer<m>:FUNction:NOISe:AOff**

Removes all noise markers in the specified window.

**Suffix:**<n> [Window](#)

&lt;m&gt; irrelevant

**Example:** `CALC:MARK:FUNC:NOIS:AOff`**CALCulate<n>:MARKer<m>:FUNction:NOISe:RESult?**

This command queries the result of the noise measurement.

To get a valid result, you have to perform a complete measurement with synchronization to the end of the measurement before reading out the result. This is only possible for single sweep mode.

See also [INITiate<n>:CONTinuous](#) on page 589.

**Suffix:**<n> [Window](#)<m> [Marker](#)**Return values:**

&lt;NoiseLevel&gt; Current noise level. The unit is the one currently active.

**Example:**           INIT:CONT OFF  
                           Switches to single sweep mode.  
                           CALC:MARK2 ON  
                           Switches on marker 2.  
                           CALC:MARK2:FUNC:NOIS ON  
                           Switches on noise measurement for marker 2.  
                           INIT;\*WAI  
                           Starts a sweep and waits for the end.  
                           CALC:MARK2:FUNC:NOIS:RES?  
                           Outputs the noise result of marker 2.

**Usage:**            Query only

**Manual operation:** See " [Noise Measurement State](#) " on page 484

---

#### **CALCulate<n>:MARKer<m>:FUNction:NOISe[:STATe] <State>**

This command turns the noise measurement at the marker position on and off.

**Suffix:**

<n>                    [Window](#)

<m>                    [Marker](#)

**Parameters:**

<State>              ON | OFF | 0 | 1  
                           **OFF | 0**  
                           Switches the function off  
                           **ON | 1**  
                           Switches the function on

**Example:**           CALC:MARK:FUNC:NOIS ON  
                           Switches on the noise measurement.

**Manual operation:** See " [Noise Measurement State](#) " on page 484  
                           See " [Switching All Noise Measurement Off](#) " on page 484

#### **9.8.8.10 Phase Noise Measurement Marker**

The following commands control the phase noise measurement marker function.

**Useful commands for phase noise markers described elsewhere**

- [CALCulate<n>:DELTaMarker<m>:FUNction:FIXed:RPOint:MAXimum\[:PEAK\]](#)
- [CALCulate<n>:DELTaMarker<m>:FUNction:FIXed:RPOint:X](#)
- [CALCulate<n>:DELTaMarker<m>:FUNction:FIXed:RPOint:Y](#)

**Remote commands exclusive to phase noise markers**

|                                                          |     |
|----------------------------------------------------------|-----|
| CALCulate<n>:DELTaMarker<m>:FUNction:PNOise:AUTO.....    | 820 |
| CALCulate<n>:DELTaMarker<m>:FUNction:PNOise:RESult?..... | 820 |
| CALCulate<n>:DELTaMarker<m>:FUNction:PNOise[:STATe]..... | 821 |
| CALCulate<n>:MARKer<m>:FUNction:PNOise:AOff.....         | 821 |
| CALCulate<n>:MARKer<m>:FUNction:PNOise:RESult?.....      | 821 |
| CALCulate<n>:MARKer<m>:FUNction:PNOise[:STATe].....      | 822 |

**CALCulate<n>:DELTaMarker<m>:FUNction:PNOise:AUTO <State>**

This command turns an automatic peak search for the fixed reference marker at the end of a sweep on and off.

**Suffix:**

<n>                      Window

<m>                      Marker

**Parameters:**

<State>                ON | OFF | 0 | 1

**OFF | 0**

Switches the function off

**ON | 1**

Switches the function on

**Example:**

CALC:DELT:FUNC:PNO:AUTO ON

Activates an automatic peak search for the reference marker in a phase-noise measurement.

**Manual operation:** See " [Defining Reference Point](#) " on page 487

**CALCulate<n>:DELTaMarker<m>:FUNction:PNOise:RESult?**

This command queries the result of a phase noise measurement.

If necessary, the command activates the measurement first.

This command is only available in the Spectrum application.

**Suffix:**

<n>                      Window

<m>                      Marker

**Return values:**

<PhaseNoise>        numeric value

The difference in level between the reference point and the noise power density at the position of the specified delta marker.

**Example:**

CALC:DELT2:FUNC:PNO:RES?

Outputs the result of phase-noise measurement of the delta-marker 2.

**Usage:**

Query only

**Manual operation:** See "[Phase Noise Measurement State](#)" on page 486

---

### CALCulate<n>:DELTaMarker<m>:FUNctioN:PNOise[:STATe] <State>

This command turns the phase noise measurement at the delta marker position on and off.

The reference marker for phase noise measurements is either a normal marker or a fixed reference. If necessary, the command turns on the reference marker.

The correction values for the bandwidth and the log amplifier are taken into account in the measurement.

**Suffix:**

<n> [Window](#)

<m> [Marker](#)

**Parameters:**

<State> ON | OFF | 0 | 1  
**OFF | 0**  
 Switches the function off  
**ON | 1**  
 Switches the function on

**Example:**

```
CALC:DELT:FUNC:PNO ON
Switches on the phase-noise measurement with all delta markers.
CALC:DELT:FUNC:FIX:RPO:X 128 MHZ
Sets the frequency reference to 128 MHz.
CALC:DELT:FUNC:FIX:RPO:Y 30 DBM
Sets the reference level to +30 dBm
```

**Manual operation:** See "[Phase Noise Measurement State](#)" on page 486  
 See "[Switching All Phase Noise Measurements Off](#)" on page 487

---

### CALCulate<n>:MARKer<m>:FUNctioN:PNOise:AOFF

Removes all phase noise markers in the specified window.

**Suffix:**

<n> [Window](#)

<m> irrelevant

**Example:**

```
CALC:MARK:FUNC:PNO:AOFF
```

---

### CALCulate<n>:MARKer<m>:FUNctioN:PNOise:RESult?

This command queries the result of a phase noise measurement.

If necessary, the command activates the measurement first.

|                       |                                                                                                                                          |
|-----------------------|------------------------------------------------------------------------------------------------------------------------------------------|
| <b>Suffix:</b>        |                                                                                                                                          |
| <n>                   | Window                                                                                                                                   |
| <m>                   | Marker                                                                                                                                   |
| <b>Return values:</b> |                                                                                                                                          |
| <PhaseNoise>          | numeric value<br>The difference between the measured carrier power and the noise power at the position of the specified (normal) marker. |
| <b>Example:</b>       | <code>CALC:MARK2:FUNC:PNO:RES?</code><br>Outputs the result of phase-noise measurement of the marker 2.                                  |
| <b>Usage:</b>         | Query only                                                                                                                               |

---

**CALCulate<n>:MARKer<m>:FUNction:PNOise[:STATe] <State>**

This command turns the phase noise measurement at the marker position on and off.

|                    |                                                                                                              |
|--------------------|--------------------------------------------------------------------------------------------------------------|
| <b>Suffix:</b>     |                                                                                                              |
| <n>                | Window                                                                                                       |
| <m>                | Marker                                                                                                       |
| <b>Parameters:</b> |                                                                                                              |
| <State>            | ON   OFF   0   1<br><b>OFF   0</b><br>Switches the function off<br><b>ON   1</b><br>Switches the function on |
| <b>Example:</b>    | <code>CALC:MARK2:FUNC:PNO ON</code><br>Switches on the phase-noise measurement for the marker 2.             |

### 9.8.8.11 Band Power Marker

The following commands control the marker for band power measurements.

#### Using Markers

|                                                                               |     |
|-------------------------------------------------------------------------------|-----|
| <code>CALCulate&lt;n&gt;:MARKer&lt;m&gt;:FUNction:BPOwer:AOff</code> .....    | 822 |
| <code>CALCulate&lt;n&gt;:MARKer&lt;m&gt;:FUNction:BPOwer:MODE</code> .....    | 823 |
| <code>CALCulate&lt;n&gt;:MARKer&lt;m&gt;:FUNction:BPOwer:RESult?</code> ..... | 823 |
| <code>CALCulate&lt;n&gt;:MARKer&lt;m&gt;:FUNction:BPOwer:SPAN</code> .....    | 824 |
| <code>CALCulate&lt;n&gt;:MARKer&lt;m&gt;:FUNction:BPOwer[:STATe]</code> ..... | 824 |

---

**CALCulate<n>:MARKer<m>:FUNction:BPOwer:AOff**

Removes all band power markers in the specified window.

|                |            |
|----------------|------------|
| <b>Suffix:</b> |            |
| <n>            | Window     |
| <m>            | irrelevant |

**Example:** `CALC:MARK:FUNC:BPOW:AOFF`

---

### **CALCulate<n>:MARKer<m>:FUNCTION:BPOWer:MODE <Mode>**

This command selects the way the results for a band power marker are displayed.

(Note: relative power results are only available for delta markers, see `CALCulate<n>:DELTAmarker<m>:FUNCTION:BPOWer:MODE` on page 824)

#### **Suffix:**

<n> [Window](#)

<m> [Marker](#)

#### **Parameters:**

<Mode> **POWer**  
Result is displayed as an absolute power. The power unit depends on the `CALCulate<n>:UNIT:POWer` setting.

**DENSity**  
Result is displayed as a density in dBm/Hz.

\*RST: POWER

**Example:** `CALC:MARK4:FUNC:BPOW:MODE DENS`  
Configures marker 4 to show the measurement results in dBm/Hz.

**Manual operation:** See "[Power Mode](#)" on page 493

---

### **CALCulate<n>:MARKer<m>:FUNCTION:BPOWer:RESult?**

This command queries the results of the band power measurement.

#### **Suffix:**

<n> [Window](#)

<m> [Marker](#)

#### **Return values:**

<Power> Signal power over the marker bandwidth.

**Example:** Activate the band power marker:  
`CALC:MARK:FUNC:BPOW:STAT ON`  
Select the density mode for the result:  
`CALC:MARK:FUNC:BPOW:MODE DENS`  
Query the result:  
`CALC:MARK:FUNC:BPOW:RES?`

Response:  
20dBm/Hz

**Usage:** Query only

**CALCulate<n>:MARKer<m>:FUNCtion:BPOWer:SPAN <Span>**

This command defines the bandwidth around the marker position.

**Suffix:**

<n> [Window](#)

<m> [Marker](#)

**Parameters:**

<Span> Frequency. The maximum span depends on the marker position and R&S FPL1000 model.

\*RST: 5% of current span

Default unit: Hz

**Example:**

CALC:MARK:FUNC:BPOW:SPAN 2MHz

Measures the band power over 2 MHz around the marker.

**Manual operation:** See "[Span](#)" on page 493

**CALCulate<n>:MARKer<m>:FUNCtion:BPOWer[:STATe] <State>**

This command turns markers for band power measurements on and off.

**Suffix:**

<n> [Window](#)

<m> [Marker](#)

**Parameters:**

<State> ON | OFF | 0 | 1

**OFF | 0**

Switches the function off

**ON | 1**

Switches the function on

**Example:**

CALC:MARK4:FUNC:BPOW:STAT ON

Activates or turns marker 4 into a band power marker.

**Manual operation:** See "[Band Power Measurement State](#)" on page 492  
See "[Switching All Band Power Measurements Off](#)" on page 493

**Using Delta Markers**

CALCulate<n>:DELTamarker<m>:FUNCtion:BPOWer:MODE..... 824

CALCulate<n>:DELTamarker<m>:FUNCtion:BPOWer:RESult?..... 825

CALCulate<n>:DELTamarker<m>:FUNCtion:BPOWer:SPAN..... 825

CALCulate<n>:DELTamarker<m>:FUNCtion:BPOWer[:STATe]..... 826

**CALCulate<n>:DELTamarker<m>:FUNCtion:BPOWer:MODE <Mode>**

This command selects the way the results for a band power delta marker are displayed.



**Suffix:**<n> [Window](#)<m> [Marker](#)**Parameters:**

&lt;Mode&gt;

**POWer**

Result is displayed as an absolute power. The power unit depends on the [CALCulate<n>:UNIT:POWer](#) setting.

**DENSity**

Result is displayed as a density in dBm/Hz.

**RPOWer**

This setting is only available for a delta band power marker. The result is the difference between the absolute power in the band around the delta marker and the absolute power for the reference marker. The powers are subtracted logarithmically, so the result is a dB value.

$$[\text{Relative band power (Delta2) in dB}] = [\text{absolute band power (Delta2) in dBm}] - [\text{absolute (band) power of reference marker in dBm}]$$

For details see "[Relative band power markers](#)" on page 491.

\*RST:       POWer

**Manual operation:** See "[Power Mode](#)" on page 493

**CALCulate<n>:DELTaMarker<m>:FUNCTION:BPOWer:RESult?**

This command queries the results of the band power measurement.

**Suffix:**<n> [Window](#)<m> [Marker](#)**Return values:**

&lt;Power&gt; Signal power over the delta marker bandwidth.

**Usage:** Query only

**CALCulate<n>:DELTaMarker<m>:FUNCTION:BPOWer:SPAN <Span>**

This command defines the bandwidth around the delta marker position.

**Suffix:**<n> [Window](#)<m> [Marker](#)**Parameters:**

&lt;Span&gt;

Frequency. The maximum span depends on the marker position and R&S FPL1000 model.

\*RST:       5% of current span

Default unit: Hz

**Manual operation:** See " [Span](#) " on page 493

---

**CALCulate<n>:DELTaMarker<m>:FUNCTioN:BPOWer[:STATe] <State>**

This command turns delta markers for band power measurements on and off.

If necessary, the command also turns on a reference marker.

**Suffix:**

<n> [Window](#)

<m> [Marker](#)

**Parameters:**

<State> ON | OFF | 0 | 1

**OFF | 0**

Switches the function off

**ON | 1**

Switches the function on

**Manual operation:** See " [Band Power Measurement State](#) " on page 492  
See " [Switching All Band Power Measurements Off](#) " on page 493

#### 9.8.8.12 n dB Down Marker

The following commands control the n dB down markers.

|                                                                                      |     |
|--------------------------------------------------------------------------------------|-----|
| <a href="#">CALCulate&lt;n&gt;:MARKer&lt;m&gt;:FUNCTioN:NDBDown</a> .....            | 826 |
| <a href="#">CALCulate&lt;n&gt;:MARKer&lt;m&gt;:FUNCTioN:NDBDown:FREQuency?</a> ..... | 827 |
| <a href="#">CALCulate&lt;n&gt;:MARKer&lt;m&gt;:FUNCTioN:NDBDown:QFACTOR?</a> .....   | 828 |
| <a href="#">CALCulate&lt;n&gt;:MARKer&lt;m&gt;:FUNCTioN:NDBDown:RESult?</a> .....    | 828 |
| <a href="#">CALCulate&lt;n&gt;:MARKer&lt;m&gt;:FUNCTioN:NDBDown:STATe</a> .....      | 828 |
| <a href="#">CALCulate&lt;n&gt;:MARKer&lt;m&gt;:FUNCTioN:NDBDown:TIME?</a> .....      | 829 |

---

**CALCulate<n>:MARKer<m>:FUNCTioN:NDBDown <Distance>**

This command defines the distance of the n dB down markers to the reference marker.

**Suffix:**

<n> [Window](#)

<m> [Marker](#)

**Parameters:**

**<Distance>** Distance of the temporary markers to the reference marker in dB.  
 For a positive offset, the markers T1 and T2 are placed *below* the active reference point.  
 For a negative offset (for example for notch filter measurements), the markers T1 and T2 are placed *above* the active reference point.  
**\*RST:** 6dB  
 Default unit: DB

**Example:**

```
CALC:MARK:FUNC:NDBD 3dB
```

Sets the distance to the reference marker to 3 dB.

**CALCulate<n>:MARKer<m>:FUNCtion:NDBDown:FREQuency?**

This command queries the position of the n dB down markers on the x-axis when measuring in the frequency domain.

To get a valid result, you have to perform a complete measurement with synchronization to the end of the measurement before reading out the result. This is only possible for single sweep mode.

See also [INITiate<n>:CONTinuous](#) on page 589.

**Suffix:**

**<n>** irrelevant  
**<m>** irrelevant

**Return values:**

**<Frequency>** **<frequency 1>**  
 absolute frequency of the n dB marker to the left of the reference marker in Hz  
**<frequency 2>**  
 absolute frequency of the n dB marker to the right of the reference marker in Hz.

**Example:**

```
INIT:CONT OFF
```

Switches to single sweep mode.

```
CALC:MARK:FUNC:NDBD ON
```

Switches on the n dB down function.

```
INIT;*WAI
```

Starts a sweep and waits for the end.

```
CALC:MARK:FUNC:NDBD:FREQ?
```

This command would return, for example, 100000000, 200000000, meaning that the first marker position is at 100 MHz, the second marker position is at 200 MHz

**Usage:** Query only

**Manual operation:** See "[n dB down Value](#)" on page 489

**CALCulate<n>:MARKer<m>:FUNCtion:NDBDown:QFACtor?**

This command queries the Q factor of n dB down measurements.

**Suffix:**

<n> irrelevant

<m> irrelevant

**Return values:**

<QFactor>

**Usage:** Query only

**CALCulate<n>:MARKer<m>:FUNCtion:NDBDown:RESult?**

This command queries the distance of the n dB down markers from each other.

To get a valid result, you have to perform a complete measurement with synchronization to the end of the measurement before reading out the result. This is only possible for single sweep mode.

See also [INITiate<n>:CONTinuous](#) on page 589.

**Suffix:**

<n> irrelevant

<m> irrelevant

**Return values:**

<Distance> The result depends on the span.  
In case of frequency domain measurements, the command returns the bandwidth between the two n dB down markers in Hz.  
In case of time domain measurements, the command returns the pulse width between the two n dB down markers in seconds.

**Example:**

```
INIT:CONT OFF
Switches to single sweep mode.
CALC:MARK:FUNC:NDBD ON
Switches on the n dB down function.
INIT;*WAI
Starts a sweep and waits for the end.
CALC:MARK:FUNC:NDBD:RES?
Outputs the measured value.
```

**Usage:** Query only

**Manual operation:** See "[n dB down Marker State](#)" on page 489

**CALCulate<n>:MARKer<m>:FUNCtion:NDBDown:STATe <State>**

This command turns the n dB Down marker function on and off.

**Suffix:**

<n> irrelevant

<m> irrelevant

**Parameters:**

<State> ON | OFF | 0 | 1  
**OFF | 0**  
 Switches the function off  
**ON | 1**  
 Switches the function on

**Example:** CALC:MARK:FUNC:NDBD:STAT ON  
 Turns the n dB Down marker on.

**Manual operation:** See "n dB down Marker State" on page 489

---

**CALCulate<n>:MARKer<m>:FUNCTion:NDBDown:TIME?**

This command queries the position of the n dB down markers on the x-axis when measuring in the time domain.

To get a valid result, you have to perform a complete measurement with synchronization to the end of the measurement before reading out the result. This is only possible for single sweep mode.

See also `INITiate<n>:CONTinuous` on page 589.

**Suffix:**

<n> irrelevant  
 <m> irrelevant

**Return values:**

<TimeX1> absolute position in time of the n dB marker to the left of the reference marker in seconds  
 <TimeX2> absolute position in time of the n dB marker to the right of the reference marker in seconds

**Example:** INIT:CONT OFF  
 Switches to single sweep mode  
 CALC:MARK:FUNC:NDBD ON  
 Switches on the n dB down function.  
 INIT;\*WAI  
 Starts a sweep and waits for the end.  
 CALC:MARK:FUNC:NDBD:TIME?  
 Outputs the time values of the temporary markers.

**Usage:** Query only

**Manual operation:** See "n dB down Value" on page 489

### 9.8.8.13 Signal Count Marker

The following commands control the frequency counter.

|                                              |     |
|----------------------------------------------|-----|
| CALCulate<n>:MARKer<m>:COUNT.....            | 830 |
| CALCulate<n>:MARKer<m>:COUNT:FREQUENCY?..... | 830 |
| CALCulate<n>:MARKer<m>:COUNT:RESolution..... | 831 |

---

### CALCulate<n>:MARKer<m>:COUNT <State>

This command turns the frequency counter at the marker position on and off.

The frequency counter works for one marker only. If you perform a frequency count with another marker, the R&S FPL1000 deactivates the frequency count of the first marker.

To get a valid result, you have to perform a complete measurement with synchronization to the end of the measurement before reading out the result. This is only possible for single sweep mode.

See also [INITiate<n>:CONTinuous](#) on page 589.

#### Suffix:

<n>                      [Window](#)

<m>                      [Marker](#)

#### Parameters:

<State>                ON | OFF | 0 | 1

#### OFF | 0

Switches the function off

#### ON | 1

Switches the function on

#### Example:

```
INIT:CONT OFF
```

Switches to single sweep mode.

```
CALC:MARK ON
```

Switches on marker 1.

```
CALC:MARK:COUN ON
```

Switches on the frequency counter for marker 1.

```
INIT;*WAI
```

Starts a sweep and waits for the end.

```
CALC:MARK:COUN:FREQ?
```

Outputs the measured value.

**Manual operation:** See "[Signal Count Marker State](#)" on page 481

---

### CALCulate<n>:MARKer<m>:COUNT:FREQUENCY?

This command queries the frequency at the marker position.

To get a valid result, you have to perform a complete measurement with synchronization to the end of the measurement before reading out the result. This is only possible for single sweep mode.

See also [INITiate<n>:CONTinuous](#) on page 589.

Before you can use the command, you have to turn on the frequency counter.

**Suffix:**<n> [Window](#)<m> [Marker](#)**Return values:**

&lt;Frequency&gt; Frequency at the marker position.

**Example:**

INIT:CONT OFF

Switches to single sweep mode.

CALC:MARK ON

Switches on marker 2.

CALC:MARK:COUN ON

Activates the frequency counter for marker 1.

INIT;\*WAI

Starts a sweep and waits for the end.

CALC:MARK:COUN:FREQ?

Outputs the measured value of marker 1.

**Usage:** Query only**Manual operation:** See "[Signal Count Marker State](#)" on page 481

---

**CALCulate<n>:MARKer<m>:COUNT:RESolution <Resolution>**

This command defines the resolution of the frequency counter.

**Suffix:**<n> [Window](#)<m> [Marker](#)**Parameters:**

&lt;Resolution&gt; 0.001 | 0.01 | 0.1 | 1 | 10 | 100 | 1000 | 10000 Hz

\*RST: 0.1 Hz

Default unit: HZ

**Example:**

CALC:MARK:COUN:RES 1kHz

Sets the resolution of the frequency counter to 1 kHz.

**Manual operation:** See "[Resolution](#)" on page 481**9.8.8.14 Marker Demodulation**

The following commands control the demodulation of AM and FM signals at the marker position.

This feature requires the optional additional interfaces (R&S FPL1-B5).

Useful commands for marker demodulation described elsewhere:

- [SYSTem:SPEaker\[:STATe\]](#) on page 755
- [SYSTem:SPEaker:VOLume](#) on page 755

**Remote commands exclusive to marker demodulation:**

|                                                              |     |
|--------------------------------------------------------------|-----|
| CALCulate<n>:MARKer<m>:FUNCTion:DEModulation:CONTinuous..... | 832 |
| CALCulate<n>:MARKer<m>:FUNCTion:DEModulation:HOLDoff.....    | 832 |
| CALCulate<n>:MARKer<m>:FUNCTion:DEModulation:SElect.....     | 833 |
| CALCulate<n>:MARKer<m>:FUNCTion:DEModulation[:STATe].....    | 833 |
| [SENSe:]DEMod:SQUelch:LEVel.....                             | 833 |
| [SENSe:]DEMod:SQUelch[:STATe].....                           | 834 |

**CALCulate<n>:MARKer<m>:FUNCTion:DEModulation:CONTinuous <State>**

This command turns continuous demodulation of the signal at the marker position in the frequency domain on and off.

In the time domain continuous demodulation is always on.

**Suffix:**

|     |        |
|-----|--------|
| <n> | Window |
| <m> | Marker |

**Parameters:**

|         |                           |
|---------|---------------------------|
| <State> | ON   OFF   0   1          |
|         | <b>OFF   0</b>            |
|         | Switches the function off |
|         | <b>ON   1</b>             |
|         | Switches the function on  |

**Example:**

CALC2:MARK3:FUNC:DEM:CONT ON  
Switches on the continuous demodulation.

**Manual operation:** See " [Continuous Demodulation](#) " on page 495

**CALCulate<n>:MARKer<m>:FUNCTion:DEModulation:HOLDoff <Duration>**

This command defines for how long the the signal at the marker position is demodulated.

In the time domain continuous demodulation is always on.

**Suffix:**

|     |        |
|-----|--------|
| <n> | Window |
| <m> | Marker |

**Parameters:**

|            |                                 |
|------------|---------------------------------|
| <Duration> | Range: 10 ms to 1000 s          |
|            | *RST: Marker demodulation = OFF |
|            | Default unit: S                 |

**Example:**

CALC:MARK:FUNC:DEM:HOLD 3s

**Manual operation:** See " [Marker Stop Time](#) " on page 495



**CALCulate<n>:MARKer<m>:FUNction:DEModulation:SElect** <DemodMode>

This command selects the demodulation mode at the marker position.

**Suffix:**

<n> [Window](#)

<m> [Marker](#)

**Parameters:**

<DemodMode> **AM**  
AM demodulation

**FM**  
FM demodulation

\*RST: AM

**Example:** CALC:MARK:FUNC:DEM:SEL FM

**Manual operation:** See "[Modulation](#)" on page 495

**CALCulate<n>:MARKer<m>:FUNction:DEModulation[:STATE]** <State>

This command turns the audio demodulator on and off when the measurement reaches a marker position.

**Suffix:**

<n> [Window](#)

<m> [Marker](#)

**Parameters:**

<State> ON | OFF | 0 | 1

**OFF | 0**  
Switches the function off

**ON | 1**  
Switches the function on

**Example:** CALC:MARK3:FUNC:DEM ON  
Switches on the demodulation for marker 3.

**Manual operation:** See "[Marker Demodulation State](#)" on page 494

**[SENSe:]DEMod:SQUelch:LEVel** <Threshold>

This command defines the threshold for selective demodulation.

All signals below the threshold are not demodulated.

**Parameters:**

<Threshold> Percentage of the display height.

Range: 0 to 100

\*RST: 50

**Example:** DEM:SQU:LEV 80  
Sets the squelch level to 80% of the displayed signal.

**[SENSe:]DEMod:SQUelch[:STATE] <State>**

This command turns selective demodulation at the marker position on and off.

For selective demodulation, the R&S FPL1000 turns on a video trigger whose level corresponds to the squelch level. Therefore it turns other triggers or gates off.

**Parameters:**

<State>                    ON | OFF | 0 | 1  
**OFF | 0**  
 Switches the function off  
**ON | 1**  
 Switches the function on

**Example:**

DEMod:SQU ON  
 Signals below the level threshold are not sent to the audio output.

### 9.8.8.15 Programming Examples for Using Markers and Marker Functions

Various programming examples on how to use markers and the special marker functions are provided here.



The use of spectrogram markers is demonstrated in [Chapter 9.8.7.7, "Programming Example: Configuring a Spectrogram"](#), on page 781.

|                                                                                                                   |     |
|-------------------------------------------------------------------------------------------------------------------|-----|
| • <a href="#">Example: Basic Markers</a> .....                                                                    | 834 |
| • <a href="#">Example: Marker Search in Spectrograms</a> .....                                                    | 836 |
| • <a href="#">Basic Frequency Sweep Measurement for Marker Function Examples</a> .....                            | 837 |
| • <a href="#">Example: Using a Fixed Reference Marker</a> .....                                                   | 837 |
| • <a href="#">Example: Obtaining a Marker Peak List</a> .....                                                     | 837 |
| • <a href="#">Example: Measuring Noise Density</a> .....                                                          | 838 |
| • <a href="#">Example: Measuring Phase Noise</a> .....                                                            | 838 |
| • <a href="#">Example: Measuring the Power in a Channel Using Band Power Markers</a> .....                        | 839 |
| • <a href="#">Example: Measuring Characteristic Bandwidths (Using the n dB Down Marker)</a><br>.....              | 840 |
| • <a href="#">Examples: Demodulating Marker Values and Providing Audio Output</a> .....                           | 841 |
| • <a href="#">Example: Performing a Highly Accurate Frequency Measurement Using the Signal Count Marker</a> ..... | 842 |

**Example: Basic Markers**

This example demonstrates how to configure and define markers for a basic spectrum measurement in a remote environment. It assumes that the basic frequency sweep described in [Chapter 9.6.16, "Programming Example: Performing a Basic Frequency Sweep"](#), on page 700 has been performed and thus does not begin by presetting the instrument.

```
//-----Configuring marker behavior -----
DISP:MTAB ON
```

## Setting Basic Spectrum RF Measurement Parameters

```

//Marker information is always displayed in a separate table.
CALC:MARK:X:SSIZ STAN
//The marker moves from one pixel to the next instead of sweep points in manual op.
CALC:MARK:PEXC 6dB
//Defines a peak excursion of 6 dB.
CALC:MARK:X:SLIM ON
CALC:MARK:X:SLIM:LEFT 50MHz
CALC:MARK:X:SLIM:RIGH 150MHz
//Restricts the search area for peaks to the frequencies between 50 and 150 MHz.
CALC:THR -100dBm
CALC:THR:STAT ON
//Configures a threshold level for peak searches at -100 dBm.

//-----Defining and positioning markers -----
CALC:MARK1 ON
//Activates marker 1 and sets it to the peak of trace 1.
CALC:MARK2:TRAC 2
//Activates marker 2 and sets it to the peak of trace 2.
CALC:MARK3:X 150MHz
//Activates marker 3 and sets it to the freq. 150 MHz on trace 1.
CALC:MARK4:TRAC 4
//Activates marker 4 and sets it to the peak of trace 4.

CALC:MARK1:MAX:AUTO ON
//Moves M1 to the current peak of trace 1 after each sweep.
CALC:MARK2:MAX:NEXT
//Moves M2 to the next lower peak of trace 2.

CALC:DELT5 ON
CALC:DELT5:LINK ON
//Activates delta marker 5 and links it to marker 1. If M1 moves, so does D5.
CALC:DELT5:MREF 4
//Changes the reference for D5 to marker 4. D5 now shows the difference between
//the peak of trace 1 after each sweep and the value at the same position in
//trace 4, which is a copy of trace 1, averaged over 10 sweeps.
CALC:DELT5:MODE REL
//Shows the difference as relative values.

CALC:DELT6 ON
CALC:DELT6:MAX:NEXT
//Activates delta marker 6 and sets it to the next lower maximum of trace 1.
//Thus it shows the difference between the two highest peaks in trace 1.

//-----Retrieving marker values -----
CALC:MARK1:Y?
CALC:MARK2:Y?
CALC:MARK3:Y?
CALC:MARK4:Y?
CALC:DELT5:Y?
CALC:DELT6:Y?

```

## Setting Basic Spectrum RF Measurement Parameters

```
//Retrieves the marker levels of each active normal and delta marker.
CALC:DELT5:X:REL?
CALC:DELT6:X:REL?
//Retrieves the frequency difference between the delta marker and marker 1.

//-----Deactivating all markers -----
//CALC:MARK:AOFF
//CALC:DELT:AOFF
```

**Example: Marker Search in Spectrograms**

This example demonstrates how to search for peak values in spectrograms in a remote environment. It assumes a spectrogram is already available (see [Chapter 9.8.7.7, "Programming Example: Configuring a Spectrogram"](#), on page 781) and thus does not begin by presetting the instrument.

```
//----- Analyzing the results using markers -----
//Set marker1 on the peak power in the most recent spectrum and query
//its position
CALC2:SPEC:FRAM:SEL 0
CALC2:MARK1 ON
CALC2:MARK1:X?
CALC2:MARK1:Y?

//Set marker2 on the peak power in frame at -324ms and query its position
CALC2:MARK2 ON
CALC2:MARK2:SGR:FRAM -324ms
CALC2:MARK2:X?
CALC2:MARK2:Y?

//Set marker3 on peak power level in the entire spectrogram in memory and
//query its position
CALC2:MARK3 ON
CALC2:MARK:SPEC:SAR MEM
CALC2:MARK3:SPEC:XY:MAX
CALC2:MARK3:X?
CALC2:MARK3:Y?

//Move marker 3 to the next lower peak level for the same frequency
CALC2:MARK3:SPEC:Y:MAX:NEXT
CALC2:MARK3:X?
CALC2:MARK3:Y?

//Set marker 4 to the highest level in the (visible) spectrogram.
CALC2:MARK:SPEC:SAR VIS
CALC2:MARK4:SPEC:XY:MAX
//Move marker 4 to the next higher level in the frames above its current position.
CALC2:MARK4:SPEC:Y:MAX:ABOV
```

### Basic Frequency Sweep Measurement for Marker Function Examples

Since markers can only be placed on an existing trace, the following example provides a simple frequency sweep measurement to be used as a basis for the subsequent marker function scripts.

```
//----- Configuring the basic frequency sweep -----
*RST
//Resets the instrument
INIT:CONT OFF
//Selects single sweep mode.
FREQ:CENT 100MHz
//Defines the center frequency
FREQ:SPAN 200MHz
//Sets the span to 100 MHz on either side of the center frequency.
DISP:TRAC1:Y:RLEV 0dBm
//Sets the reference level to 0 dBm.

//----- Performing the measurement -----
INIT;*WAI
//Performs a measurement and waits for it to end
```

### Example: Using a Fixed Reference Marker

This example demonstrates how to configure and use reference markers in a basic spectrum measurement in a remote environment. It assumes that the basic frequency sweep described in ["Basic Frequency Sweep Measurement for Marker Function Examples"](#) on page 837 has been performed and thus does not begin by presetting the instrument.

```
//-----Configuring the reference marker -----
//Activate a fixed reference marker. It is set to the current maximum of trace 1.
CALC:DELT:FUNC:FIX ON
//Set the reference frequency to 128 MHz.
CALC:DELT:FUNC:FIX:RPO:X 128 MHZ
//Set the reference level to +30 dBm.
CALC:DELT:FUNC:FIX:RPO:Y 30 DBM

//Use the fixed reference marker as a reference for deltamarker 2
CALC:DELT2:MREF FIX

//Reset the reference marker to the current maximum of trace 1
CALC:DELT:FUNC:FIX:RPO:MAX
//Query the new position of the reference marker
CALC:DELT:FUNC:FIX:RPO:X?
CALC:DELT:FUNC:FIX:RPO:Y?
```

### Example: Obtaining a Marker Peak List

This example demonstrates how to obtain a marker peak list in a basic spectrum measurement in a remote environment. It assumes that the basic frequency sweep described in ["Basic Frequency Sweep Measurement for Marker Function Examples"](#)

on page 837 has been performed and thus does not begin by presetting the instrument.

In this example, the peak search is restricted to the frequency range of 50 MHz to 150 MHz. The top 5 power levels with a peak excursion of 10dB and a minimum of -100 dBm are to be determined and displayed with their marker numbers. The results are sorted by frequency values. The resulting peak list is then exported to a file.

```
//----- Configuring the peak search -----
CALC:MARK:X:SLIM ON
CALC:MARK:X:SLIM:LEFT 50MHz
CALC:MARK:X:SLIM:RIGH 150MHz
CALC:MARK:PEXC 10DB
CALC:THR -100DBM
CALC:THR:STAT ON

CALC:MARK:FUNC:FPE:STAT ON
CALC:MARK:FUNC:FPE:LIST:SIZE 5
CALC:MARK:FUNC:FPE:SORT X
CALC:MARK:FUNC:FPE:ANN:LAB ON

//----- Retrieving results -----
CALC:MARK:FUNC:FPE:COUN?
CALC:MARK:FUNC:FPE:X?
CALC:MARK:FUNC:FPE:Y?

//----- Exporting the peak list -----
MMEM:STOR:PEAK 'PeakList'
```

### Example: Measuring Noise Density

This example demonstrates how to measure noise density using noise markers in a basic spectrum measurement in a remote environment. It assumes that the basic frequency sweep described in "[Basic Frequency Sweep Measurement for Marker Function Examples](#)" on page 837 has been performed and thus does not begin by presetting the instrument.

```
CALC:MARK1:FUNC:NOIS ON
//Switches on noise measurement at marker 1.

INIT;*WAI
//Performs a measurement and waits for it to end

CALC:MARK1:FUNC:NOIS:RES?
//Queries the measured noise level (per Hz bandwidth)
```

### Example: Measuring Phase Noise

This example demonstrates how to measure phase noise using markers in a basic spectrum measurement in a remote environment. It assumes that the basic frequency sweep described in "[Basic Frequency Sweep Measurement for Marker Function Exam-](#)

## Setting Basic Spectrum RF Measurement Parameters

ples" on page 837 has been performed and thus does not begin by presetting the instrument.

```
//----- Configuring the phase noise marker -----
DET SAMP
//Switches to Sample detector

CALC:MARK1 ON
//Activates marker1 and sets it to the maximum power level

CALC:DELT:FUNC:PNO ON
//Activates phase noise marker function

CALC:DELT1 ON
CALC:DELT1:X 100kHz

CALC:DELT2 ON
CALC:DELT2:X 500kHz

CALC:DELT3 ON
CALC:DELT3:X 1MHz

CALC:DELT4 ON
CALC:DELT4:X 1.5MHz

//Activates the phase noise measurement function for offsets 100kHz/500kHz/1MHz/1.5MHz.

BAND:VID?
//Queries the used VBW (= 0.1*RBW)

//----- Querying the phase noise results -----

CALC:DELT1:FUNC:PNO:RES?
CALC:DELT2:FUNC:PNO:RES?
CALC:DELT3:FUNC:PNO:RES?
CALC:DELT4:FUNC:PNO:RES?
//Queries the difference in level between the peak and the noise power density
//measured at the deltamarkers, referred to the carrier power level (dBc)
```

### Example: Measuring the Power in a Channel Using Band Power Markers

This example demonstrates how to measure the power in a specific channel or band using markers in a basic spectrum measurement in a remote environment. It assumes that the basic frequency sweep described in "[Basic Frequency Sweep Measurement for Marker Function Examples](#)" on page 837 has been performed and thus does not begin by presetting the instrument.

```
//----- Configuring the band power marker -----
CALC:MARK1 ON
//Activates marker1 and sets it to the maximum power level
```

## Setting Basic Spectrum RF Measurement Parameters

```

CALC:MARK1:FUNC:BPOW:STAT ON
//Activates the band power measurement for the band around marker 1
CALC:MARK1:FUNC:BPOW:SPAN 30MHz
//Sets the bandwidth to be measured to 30 MHz
CALC:MARK1:FUNC:BPOW:MODE DENS
//Sets the result to be a density (power per Hz bandwidth)

CALC:DELT2 ON
//Activates deltamarker2
CALC:DELT2:FUNC:BPOW:STAT ON
//Activates the band power measurement for the band around deltamarker 2
CALC:DELT2:FUNC:BPOW:SPAN 30MHz
//Sets the bandwidth to be measured to 30 MHz
CALC:DELT2:FUNC:BPOW:MODE DENS
//Sets the result to be a density (power per Hz bandwidth)

CALC:DELT3 ON
//Activates deltamarker3
CALC:DELT3:FUNC:BPOW:STAT ON
//Activates the band power measurement for the band around deltamarker 3
CALC:DELT3:FUNC:BPOW:SPAN 30MHz
//Sets the bandwidth to be measured to 30 MHz
CALC:DELT3:FUNC:BPOW:MODE DENS
//Sets the result to be a density (power per Hz bandwidth)

//-----Retrieving Results-----
CALC:MARK1:FUNC:BPOW:RES?
//Returns the power sum for the specified bandwidth around marker 1.
CALC:DELT2:FUNC:BPOW:RES?
//Returns the power sum for the specified bandwidth around deltamarker 2.
CALC:DELT3:FUNC:BPOW:RES?
//Returns the power sum for the specified bandwidth around deltamarker 3.

```

**Example: Measuring Characteristic Bandwidths (Using the n dB Down Marker)**

This example demonstrates how to measure a characteristic bandwidth using markers in a basic spectrum measurement in a remote environment. It assumes that the basic frequency sweep described in [Chapter 9.6.16, "Programming Example: Performing a Basic Frequency Sweep"](#), on page 700 has been performed and thus does not begin by presetting the instrument.

```

//----- Configuring the n dB down marker -----
CALC:MARK1 ON
//Activates marker1 and sets it to the maximum power level
CALC:MARK1:FUNC:NDBD 3DB
//Sets the level offset to 3 dB
CALC:MARK1:FUNC:NDBD:STAT ON
//Activates the n dB down measurement

//-----Retrieving Results-----
CALC:MARK:FUNC:NDBD:RES?

```



## Setting Basic Spectrum RF Measurement Parameters

```
//Returns the bandwidth at the specified power offset.
CALC:MARK:FUNC:NDBD:FREQ?
//Returns the frequencies of the temporary markers at the power offsets
CALC:MARK:FUNC:NDBD:QFAC?
//Returns the quality factor of the resulting bandwidth
```

**Examples: Demodulating Marker Values and Providing Audio Output**

The following examples demonstrate how to demodulate markers and provide audio output in a remote environment.

- [Example: Providing Audio Output for Individual Marker Values](#).....841
- [Example: Demodulating and Providing Audio Output Continuously](#)..... 841

**Example: Providing Audio Output for Individual Marker Values**

This example demonstrates how to demodulate markers and provide audio output in a basic spectrum measurement in a remote environment. It assumes that the basic frequency sweep described in [Chapter 9.6.16, "Programming Example: Performing a Basic Frequency Sweep"](#), on page 700 has been performed and thus does not begin by presetting the instrument.

Audio output is provided for 5s each time the signal reaches its initial maximum, however only if it is higher than -90 dBm (10% of the total y-axis range) in order to ignore noise.

```
//----- Configuring the marker demodulation -----
CALC:MARK1 ON
//Activates marker1 and sets it to the maximum power level
CALC:MARK1:FUNC:DEM:SEL FM
//Selects FM demodulation
CALC:MARK1:FUNC:DEM:HOLD 5s
//Defines an output duration of 5s
DEM:SQU:LEV 10
//Sets a squelch level for noise
DEM:SQU ON
//Activates squelching
CALC:MARK1:FUNC:DEM ON
//Activates demodulation

//----- Performing the measurement -----
INIT;*WAI
//Performs a measurement and waits for it to end

//-----Retrieving Results-----
//Results are only provided as audio output!
```

**Example: Demodulating and Providing Audio Output Continuously**

This example demonstrates how to demodulate markers and provide audio output in a basic spectrum measurement in a remote environment. It assumes that the basic frequency sweep described in [Chapter 9.6.16, "Programming Example: Performing a](#)

[Basic Frequency Sweep](#)", on page 700 has been performed and thus does not begin by presetting the instrument.

```
//----- Configuring the marker demodulation -----
CALC:MARK1 ON
//Activates marker1
CALC:MARK1:FUNC:DEM:SEL FM
//Selects FM demodulation
DEM:SQU:LEV 10
//Sets a squelch level for noise
DEM:SQU ON
//Activates squelching
CALC:MARK1:FUNC:DEM:CONT ON
//Activates continuous demodulation

//----- Performing the measurement -----
INIT:CONT ON
//Performs a measurement and provides continuous audio output

//-----Retrieving Results-----
//Results are only provided as audio output!
```

#### **Example: Performing a Highly Accurate Frequency Measurement Using the Signal Count Marker**

This example demonstrates how to determine highly accurate frequency values using signal count markers in a basic spectrum measurement in a remote environment. It assumes that the basic frequency sweep described in [Chapter 9.6.16, "Programming Example: Performing a Basic Frequency Sweep"](#), on page 700 has been performed and thus does not begin by presetting the instrument.

```
//----- Configuring the signal count marker -----
CALC:MARK1 ON
//Activates marker1
CALC:MARK1:COUN ON
//Switches on the frequency counter for marker 1.
CALC:MARK1:COUN:RES 1kHz
//Sets the resolution of the frequency counter to 1kHz

//----- Performing the measurement -----
INIT;*WAI
//Performs a measurement and waits for it to end

//-----Retrieving Results-----
CALC:MARK1:COUN:FREQ?
//Returns the signal counter value as the precise marker frequency.
```

## 9.8.9 Configuring Display and Limit Lines

The commands required to configure display and limit lines in a remote environment are described here.

- [Configuring Display Lines](#)..... 843
- [Defining Limit Checks](#)..... 845

### 9.8.9.1 Configuring Display Lines

The following commands configure vertical and horizontal display lines.

|                                                                |     |
|----------------------------------------------------------------|-----|
| <a href="#">CALCulate&lt;n&gt;:DLINe&lt;dl&gt;</a> .....       | 843 |
| <a href="#">CALCulate&lt;n&gt;:DLINe&lt;dl&gt;:STATe</a> ..... | 843 |
| <a href="#">CALCulate&lt;n&gt;:FLINe&lt;dl&gt;</a> .....       | 844 |
| <a href="#">CALCulate&lt;n&gt;:FLINe&lt;dl&gt;:STATe</a> ..... | 844 |
| <a href="#">CALCulate&lt;n&gt;:TLINe&lt;dl&gt;</a> .....       | 844 |
| <a href="#">CALCulate&lt;n&gt;:TLINe&lt;dl&gt;:STATe</a> ..... | 845 |

---

#### **CALCulate<n>:DLINe<dl>** <Position>

This command defines the (horizontal) position of a display line.

##### **Suffix:**

<n>                    [Window](#)

<dl>                    1 | 2

##### **Parameters:**

<Position>            The value range is variable.  
You can use any unit you want, the R&S FPL1000 then converts the unit to the currently selected unit. If you omit a unit, the R&S FPL1000 uses the currently selected unit.

\*RST:                (state is OFF)

Default unit: DBM

##### **Example:**

CALC:DLIN2 -20dBm

Positions the second display line at -20 dBm.

**Manual operation:** See "[Horizontal Line 1 / Horizontal Line 2](#)" on page 537

---

#### **CALCulate<n>:DLINe<dl>:STATe** <State>

This command turns a display line on and off

##### **Suffix:**

<n>                    [Window](#)

<dl>                    1 | 2

##### **Parameters:**

<State>                ON | OFF | 0 | 1

**OFF | 0**

Switches the function off

**ON | 1**

Switches the function on

**Example:** `CALC:DLIN2:STAT ON`  
Turns on display line 2.

**CALCulate<n>:FLINe<dl> <Frequency>**

This command defines the position of a frequency line.

**Suffix:**<n> [Window](#)<dl> 1 to 4  
frequency line**Parameters:**

&lt;Frequency&gt; Note that you can not set a frequency line to a position that is outside the current span.

Range: 0 Hz to Fmax

\*RST: (STATe to OFF)

Default unit: HZ

**Example:** `CALC:FLIN2 120MHz`  
Sets frequency line 2 to a frequency of 120 MHz.

**Manual operation:** See "[Vertical Line <x>](#)" on page 537**CALCulate<n>:FLINe<dl>:STATe <State>**

This command turns a frequency line on and off

**Suffix:**<n> [Window](#)<dl> 1 to 4  
frequency line**Parameters:**

&lt;State&gt; ON | OFF | 0 | 1

**OFF | 0**

Switches the function off

**ON | 1**

Switches the function on

**Example:** `CALC:FLIN2:STAT ON`  
Turns frequency line 2 on.

**CALCulate<n>:TLINe<dl> <Time>**

This command defines the position of a time line.

**Suffix:**<n> [Window](#)

<dl> 1 to 4  
time line

**Parameters:**

<Time> Note that you can not set a time line to a position that is higher than the current sweep time.

Range: 0 s to 1600 s

\*RST: (STATe to OFF)

Default unit: S

**Example:**

CALC:TLIN 10ms

Sets the first time line to 10 ms.

**Manual operation:** See "[Vertical Line <x>](#)" on page 537

**CALCulate<n>:TLIN<dl>:STATe <State>**

This command turns a time line on and off

**Suffix:**

<n> [Window](#)

<dl> 1 to 4  
time line

**Parameters:**

<State> ON | OFF | 0 | 1

**OFF | 0**

Switches the function off

**ON | 1**

Switches the function on

**Example:**

CALC:TLIN:STAT ON

Turns the first time line on.

**9.8.9.2 Defining Limit Checks**

Note that in remote control, upper and lower limit lines are configured using separate commands. Thus, you must decide in advance which you want to configure. The x-values for both upper and lower limit lines are defined as a common control line. This control line is the reference for the y-values for both upper and lower limit lines.

- [Configuring Limit Lines](#).....845
- [Managing Limit Lines](#).....855
- [Checking the Results of a Limit Check](#).....858
- [Programming Example: Using Limit Lines](#).....859

**Configuring Limit Lines**

|                                            |     |
|--------------------------------------------|-----|
| CALCulate<n>:LIMit<li>:COMMeNt.....        | 846 |
| CALCulate<n>:LIMit<li>:CONTRol[:DATA]..... | 846 |
| CALCulate<n>:LIMit<li>:CONTRol:DOMain..... | 847 |
| CALCulate<n>:LIMit<li>:CONTRol:MODE.....   | 847 |

|                                             |     |
|---------------------------------------------|-----|
| CALCulate<n>:LIMit<li>:CONTRol:OFFSet.....  | 848 |
| CALCulate<n>:LIMit<li>:CONTRol:SHIFt.....   | 848 |
| CALCulate<n>:LIMit<li>:CONTRol:SPACing..... | 848 |
| CALCulate<n>:LIMit<li>:LOWer[:DATA].....    | 849 |
| CALCulate<n>:LIMit<li>:LOWer:MARGin.....    | 849 |
| CALCulate<n>:LIMit<li>:LOWer:MODE.....      | 849 |
| CALCulate<n>:LIMit<li>:LOWer:OFFSet.....    | 850 |
| CALCulate<n>:LIMit<li>:LOWer:SHIFt.....     | 850 |
| CALCulate<n>:LIMit<li>:LOWer:SPACing.....   | 850 |
| CALCulate<n>:LIMit<li>:LOWer:STATe.....     | 851 |
| CALCulate<n>:LIMit<li>:LOWer:THReshold..... | 851 |
| CALCulate<n>:LIMit<li>:NAME.....            | 851 |
| CALCulate<n>:LIMit<li>:UNIT.....            | 852 |
| CALCulate<n>:LIMit<li>:UPPer[:DATA].....    | 852 |
| CALCulate<n>:LIMit<li>:UPPer:MARGin.....    | 853 |
| CALCulate<n>:LIMit<li>:UPPer:MODE.....      | 853 |
| CALCulate<n>:LIMit<li>:UPPer:OFFSet.....    | 853 |
| CALCulate<n>:LIMit<li>:UPPer:SHIFt.....     | 854 |
| CALCulate<n>:LIMit<li>:UPPer:SPACing.....   | 854 |
| CALCulate<n>:LIMit<li>:UPPer:STATe.....     | 854 |
| CALCulate<n>:LIMit<li>:UPPer:THReshold..... | 855 |

---

**CALCulate<n>:LIMit<li>:COMMeNt <Comment>**

This command defines a comment for a limit line.

**Suffix:**

<n>                    irrelevant

<li>                    [Limit line](#)

**Parameters:**

<Comment>            String containing the description of the limit line.

**Manual operation:**    See "[Comment](#)" on page 546

---

**CALCulate<n>:LIMit<li>:CONTRol[:DATA] <LimitLinePoints>**

This command defines the horizontal definition points of a limit line.

**Suffix:**

<n>                    irrelevant

<li>                    [Limit line](#)

**Parameters:**

<LimitLinePoints> Variable number of x-axis values.  
 Note that the number of horizontal values has to be the same as the number of vertical values set with `CALCulate<n>:LIMit<li>:LOWer[:DATA]` or `CALCulate<n>:LIMit<li>:UPPer[:DATA]`. If not, the R&S FPL1000 either adds missing values or ignores surplus values.  
 The unit is Hz or s.  
 \*RST: -  
 Default unit: HZ

**Manual operation:** See " [Data Points](#) " on page 547

**CALCulate<n>:LIMit<li>:CONTrol:DOMain <SpanSetting>**

This command selects the domain of the limit line.

**Suffix:**

<n> irrelevant  
 <li> [Limit line](#)

**Parameters:**

<SpanSetting> FREQUENCY | TIME  
**FREQUENCY**  
 For limit lines that apply to a range of frequencies.  
**TIME**  
 For limit lines that apply to a period of time.  
 \*RST: FREQUENCY

**Example:**

`CALC:LIM:CONT:DOM FREQ`  
 Select a limit line in the frequency domain.

**Manual operation:** See " [X-Axis](#) " on page 547

**CALCulate<n>:LIMit<li>:CONTrol:MODE <Mode>**

This command selects the horizontal limit line scaling.

**Suffix:**

<n> irrelevant  
 <li> [Limit line](#)

**Parameters:**

<Mode> **ABSolute**  
 Limit line is defined by absolute physical values (Hz or s).  
**RELative**  
 Limit line is defined by relative values related to the center frequency (frequency domain) or the left diagram border (time domain).  
 \*RST: ABSolute

**CALCulate<n>:LIMit<li>:CONTrol:OFFSet <Offset>**

This command defines an offset for a complete limit line.

Compared to shifting the limit line, an offset does not actually change the limit line definition points.

**Suffix:**

<n> irrelevant  
<li> [Limit line](#)

**Parameters:**

<Offset> Numeric value.  
The unit depends on the scale of the x-axis.  
\*RST: 0  
Default unit: HZ

**Manual operation:** See "[X-Offset](#)" on page 544

**CALCulate<n>:LIMit<li>:CONTrol:SHIFt <Distance>**

This command moves a complete limit line horizontally.

Compared to defining an offset, this command actually changes the limit line definition points by the value you define.

**Suffix:**

<n> irrelevant  
<li> [Limit line](#)

**Parameters:**

<Distance> Numeric value.  
The unit depends on the scale of the x-axis.  
Default unit: HZ

**Manual operation:** See "[Shift x](#)" on page 548

**CALCulate<n>:LIMit<li>:CONTrol:SPACing <InterpolMode>**

This command selects linear or logarithmic interpolation for the calculation of limit lines from one horizontal point to the next.

**Suffix:**

<n> [Window](#)  
<li> [Limit line](#)

**Parameters:**

<InterpolMode> LINear | LOGarithmic  
\*RST: LIN

**Example:** CALC:LIM:CONT:SPAC LIN

**Manual operation:** See "[X-Axis](#)" on page 547



---

**CALCulate<n>:LIMit<li>:LOWer[:DATA] <LimitLinePoints>**

This command defines the vertical definition points of a lower limit line.

**Suffix:**

<n> irrelevant

<li> [Limit line](#)

**Parameters:**

<LimitLinePoints> Variable number of level values.  
Note that the number of vertical values has to be the same as the number of horizontal values set with [CALCulate<n>:LIMit<li>:CONTRol\[:DATA\]](#). If not, the R&S FPL1000 either adds missing values or ignores surplus values.  
The unit depends on [CALCulate<n>:LIMit<li>:UNIT](#) on page 852.  
\*RST: Limit line state is OFF  
Default unit: DBM

**Manual operation:** See "[Data Points](#)" on page 547

---

**CALCulate<n>:LIMit<li>:LOWer:MARGin <Margin>**

This command defines an area around a lower limit line where limit check violations are still tolerated.

**Suffix:**

<n> irrelevant

<li> [Limit line](#)

**Parameters:**

<Margin> **numeric value**  
\*RST: 0  
Default unit: dB

**Manual operation:** See "[Margin](#)" on page 547

---

**CALCulate<n>:LIMit<li>:LOWer:MODE <Mode>**

This command selects the vertical limit line scaling.

**Suffix:**

<n> [Window](#)

<li> [Limit line](#)

**Parameters:**

<Mode> **ABSolute**  
Limit line is defined by absolute physical values.  
The unit is variable.

**RELative**

Limit line is defined by relative values related to the reference level (dB).

\*RST: ABSolute

**Manual operation:** See " X-Axis " on page 547

**CALCulate<n>:LIMit<li>:LOWer:OFFSet <Offset>**

This command defines an offset for a complete lower limit line.

Compared to shifting the limit line, an offset does not actually change the limit line definition points.

**Suffix:**

<n> [Window](#)

<li> [Limit line](#)

**Parameters:**

<Offset> Numeric value.

\*RST: 0

Default unit: dB

**Manual operation:** See " Y-Offset " on page 545

**CALCulate<n>:LIMit<li>:LOWer:SHIFt <Distance>**

This command moves a complete lower limit line vertically.

Compared to defining an offset, this command actually changes the limit line definition points by the value you define.

**Suffix:**

<n> [Window](#)

<li> [Limit line](#)

**Parameters:**

<Distance> Defines the distance that the limit line moves.

The unit depends on [CALCulate<n>:LIMit<li>:UNIT](#) on page 852.

Default unit: DB

**Manual operation:** See " Shift y " on page 548

**CALCulate<n>:LIMit<li>:LOWer:SPACing <InterpolType>**

This command selects linear or logarithmic interpolation for the calculation of a lower limit line from one horizontal point to the next.

**Suffix:**

<n> [Window](#)

<li> [Limit line](#)

**Parameters:**

<InterpolType> LINear | LOGarithmic  
 \*RST: LIN

**Manual operation:** See " [Y-Axis](#) " on page 547

**CALCulate<n>:LIMit<li>:LOWer:STATE <State>**

This command turns a lower limit line on and off.

Before you can use the command, you have to select a limit line with [CALCulate<n>:LIMit<li>:NAME](#) on page 851.

**Suffix:**

<n> irrelevant

<li> [Limit line](#)

**Parameters:**

<State> ON | OFF | 0 | 1  
**OFF | 0**  
 Switches the function off  
**ON | 1**  
 Switches the function on

**Manual operation:** See " [Visibility](#) " on page 544

**CALCulate<n>:LIMit<li>:LOWer:THReshold <Threshold>**

This command defines a threshold for relative limit lines.

The R&S FPL1000 uses the threshold for the limit check, if the limit line violates the threshold.

**Suffix:**

<n> irrelevant

<li> [Limit line](#)

**Parameters:**

<Threshold> Numeric value.  
 The unit depends on [CALCulate<n>:LIMit<li>:UNIT](#) on page 852.  
 \*RST: -200 dBm  
 Default unit: DBM

**Manual operation:** See " [Threshold](#) " on page 546

**CALCulate<n>:LIMit<li>:NAME <Name>**

This command selects a limit line that already exists or defines a name for a new limit line.

**Suffix:**<n> [Window](#)<li> [Limit line](#)**Parameters:**

&lt;Name&gt; String containing the limit line name.

\*RST: REM1 to REM8 for lines 1 to 8

**Manual operation:** See "[Name](#)" on page 546**CALCulate<n>:LIMit<li>:UNIT <Unit>**

This command defines the unit of a limit line.

**Suffix:**

&lt;n&gt; irrelevant

<li> [Limit line](#)**Parameters:**

&lt;Unit&gt; DBM | DBPW | WATT | DBUV | DBMV | VOLT | DBUA | AMPere | DB | DBUV\_M | DBUA\_M | (unitless)

If you select dB as the limit line unit, the command automatically turns the limit line into a relative limit line.

\*RST: DBM

**Manual operation:** See "[Y-Axis](#)" on page 547**CALCulate<n>:LIMit<li>:UPPer[:DATA] <LimitLinePoints>**

This command defines the vertical definition points of an upper limit line.

**Suffix:**

&lt;n&gt; irrelevant

<li> [Limit line](#)**Parameters:**

&lt;LimitLinePoints&gt; Variable number of level values.

Note that the number of vertical values has to be the same as the number of horizontal values set with [CALCulate<n>:LIMit<li>:CONTRol\[:DATA\]](#). If not, the R&S FPL1000 either adds missing values or ignores surplus values.The unit depends on [CALCulate<n>:LIMit<li>:UNIT](#) on page 852.

\*RST: Limit line state is OFF

Default unit: DBM

**Manual operation:** See "[Data Points](#)" on page 547

---

**CALCulate<n>:LIMit<li>:UPPer:MARGin <Margin>**

This command defines an area around an upper limit line where limit check violations are still tolerated.

**Suffix:**

<n> irrelevant

<li> [Limit line](#)

**Parameters:**

<Margin> **numeric value**

\*RST: 0

Default unit: dB

**Manual operation:** See "[Margin](#)" on page 547

---

**CALCulate<n>:LIMit<li>:UPPer:MODE <Mode>**

This command selects the vertical limit line scaling.

**Suffix:**

<n> [Window](#)

<li> [Limit line](#)

**Parameters:**

<Mode>

**ABSolute**

Limit line is defined by absolute physical values.  
The unit is variable.

**RELative**

Limit line is defined by relative values related to the reference level (dB).

\*RST: ABSolute

**Manual operation:** See "[X-Axis](#)" on page 547

---

**CALCulate<n>:LIMit<li>:UPPer:OFFSet <Offset>**

This command defines an offset for a complete upper limit line.

Compared to shifting the limit line, an offset does not actually change the limit line definition points.

**Suffix:**

<n> irrelevant

<li> [Limit line](#)

**Parameters:**

<Offset> Numeric value.

\*RST: 0

Default unit: dB

**Manual operation:** See "[Y-Offset](#)" on page 545

**CALCulate<n>:LIMit<li>:UPPer:SHIFt** <Distance>

This command moves a complete upper limit line vertically.

Compared to defining an offset, this command actually changes the limit line definition points by the value you define.

**Suffix:**

<n> irrelevant

<li> [Limit line](#)

**Parameters:**

<Distance> Defines the distance that the limit line moves.  
The unit depends on [CALCulate<n>:LIMit<li>:UNIT](#) on page 852.

**Manual operation:** See "[Shift y](#)" on page 548

**CALCulate<n>:LIMit<li>:UPPer:SPACIng** <InterpolType>

This command selects linear or logarithmic interpolation for the calculation of an upper limit line from one horizontal point to the next.

**Suffix:**

<n> [Window](#)

<li> [Limit line](#)

**Parameters:**

<InterpolType> LINear | LOGarithmic  
\*RST: LIN

**Manual operation:** See "[Y-Axis](#)" on page 547

**CALCulate<n>:LIMit<li>:UPPer:STATe** <State>

This command turns an upper limit line on and off.

Before you can use the command, you have to select a limit line with [CALCulate<n>:LIMit<li>:NAME](#) on page 851.

**Suffix:**

<n> irrelevant

<li> [Limit line](#)

**Parameters:**

<State> ON | OFF | 0 | 1  
**OFF | 0**  
Switches the function off  
**ON | 1**  
Switches the function on

**Manual operation:** See "[Visibility](#)" on page 544

**CALCulate<n>:LIMit<li>:UPPer:THReshold <Limit>**

This command defines an absolute limit for limit lines with a relative scale.

The R&S FPL1000 uses the threshold for the limit check, if the limit line violates the threshold.

**Suffix:**

<n> irrelevant  
<li> Limit line

**Parameters:**

<Limit> Numeric value.  
The unit depends on `CALCulate<n>:LIMit<li>:UNIT` on page 852.  
\*RST: -200  
Default unit: dBm

**Manual operation:** See " [Threshold](#) " on page 546

**Managing Limit Lines**

Useful commands for managing limit lines described in the R&S FPL1000 User Manual:

- `MMEM:SEL[:ITEM]:LIN:ALL`
- `MMEM:STOR:TYPE`

**Remote commands exclusive to managing limit lines:**

|                                                                            |     |
|----------------------------------------------------------------------------|-----|
| <code>CALCulate&lt;n&gt;:LIMit&lt;li&gt;:ACTive?</code> .....              | 855 |
| <code>CALCulate&lt;n&gt;:LIMit&lt;li&gt;:COPY</code> .....                 | 856 |
| <code>CALCulate&lt;n&gt;:LIMit&lt;li&gt;:DELeTe</code> .....               | 856 |
| <code>CALCulate&lt;n&gt;:LIMit&lt;li&gt;:STATe</code> .....                | 856 |
| <code>CALCulate&lt;n&gt;:LIMit&lt;li&gt;:TRACe&lt;t&gt;:CHECK</code> ..... | 857 |
| <code>MMEMory:LOAD&lt;n&gt;:LIMit</code> .....                             | 857 |
| <code>MMEMory:STORe&lt;n&gt;:LIMit</code> .....                            | 857 |

**CALCulate<n>:LIMit<li>:ACTive?**

This command queries the names of *all* active limit lines.

**Suffix:**

<n> irrelevant  
<li> irrelevant

**Return values:**

<LimitLines> String containing the names of all active limit lines in alphabetical order.

**Example:**

`CALC:LIM:ACT?`  
Queries the names of all active limit lines.

**Usage:** Query only

**Manual operation:** See " [Visibility](#) " on page 544

---

### CALCulate<n>:LIMit<li>:COPY <Line>

This command copies a limit line.

**Suffix:**

<n> [Window](#)

<li> [Limit line](#)

**Parameters:**

<Line> **1 to 8**  
number of the new limit line

**<name>**

String containing the name of the limit line.

**Example:**

CALC:LIM1:COPY 2

Copies limit line 1 to line 2.

CALC:LIM1:COPY 'FM2'

Copies limit line 1 to a new line named FM2.

**Manual operation:** See " [Copy Line](#) " on page 545

---

### CALCulate<n>:LIMit<li>:DELEte

This command deletes a limit line.

**Suffix:**

<n> [Window](#)

<li> [Limit line](#)

**Manual operation:** See " [Delete Line](#) " on page 545

---

### CALCulate<n>:LIMit<li>:STATE <State>

This command turns the limit check for a specific limit line on and off.

To query the limit check result, use [CALCulate<n>:LIMit<li>:FAIL?](#).

Note that a new command exists to activate the limit check and define the trace to be checked in one step (see [CALCulate<n>:LIMit<li>:TRACe<t>:CHECK](#) on page 857).

**Suffix:**

<n> irrelevant

<li> [Limit line](#)

**Parameters:**

<State> ON | OFF | 0 | 1

**OFF | 0**

Switches the function off



**ON | 1**

Switches the function on

**Example:** `CALC:LIM:STAT ON`  
Switches on the limit check for limit line 1.

**Manual operation:** See " [Disable All Lines](#) " on page 545

**CALCulate<n>:LIMit<li>:TRACe<t>:CHECK <State>**

This command turns the limit check for a specific trace on and off.

To query the limit check result, use `CALCulate<n>:LIMit<li>:FAIL?`.**Suffix:**

<n> [Window](#)  
<li> [Limit line](#)  
<t> [Trace](#)

**Parameters:**

<State> `ON | OFF | 0 | 1`  
**OFF | 0**  
Switches the function off  
**ON | 1**  
Switches the function on

**Example:** `CALC:LIM3:TRAC2:CHEC ON`  
Switches on the limit check for limit line 3 on trace 2.

**Manual operation:** See " [Traces to be Checked](#) " on page 544

**MMEMy:LOAD<n>:LIMit <FileName>**

Loads the limit line from the selected file in .CSV format.

**Suffix:**

<n> irrelevant

**Parameters:**

<FileName> String containing the path and name of the CSV import file.

**Example:** `MMEM:LOAD:LIM 'C:\TEST.CSV'`

**Manual operation:** See " [Import](#) " on page 548

**MMEMy:STORe<n>:LIMit <FileName>, <LimitLineName>**

This command exports limit line data to an ASCII (CSV) file.

For details on the file format see [Chapter 8.11.2.4, "Reference: Limit Line File Format"](#), on page 553.

**Suffix:**

<n> irrelevant

**Parameters:**

<FileName> String containing the path and name of the target file.

<LimitLineName> Name of the limit line to be exported.

**Example:**

```
MMEM:STOR:LIM 'C:\TEST', 'UpperLimitLine'
Stores the limit line named "UpperLimitLine" in the file
TEST.CSV.
```

**Manual operation:** See " [Export](#) " on page 548

**Checking the Results of a Limit Check**

[CALCulate<n>:LIMit<li>:CLEar\[:IMMediate\]](#)..... 858

[CALCulate<n>:LIMit<li>:FAIL?](#)..... 858

**CALCulate<n>:LIMit<li>:CLEar[:IMMediate]**

This command deletes the result of the current limit check.

The command works on *all* limit lines in *all* measurement windows at the same time.

**Suffix:**

<n> [Window](#)

<li> irrelevant

**Example:**

```
CALC:LIM:CLE
Deletes the result of the limit check.
```

**CALCulate<n>:LIMit<li>:FAIL?**

This command queries the result of a limit check in the specified window.

Note that for SEM measurements, the limit line suffix <li> is irrelevant, as only one specific SEM limit line is checked for the currently relevant power class.

To get a valid result, you have to perform a complete measurement with synchronization to the end of the measurement before reading out the result. This is only possible for single sweep mode.

See also [INITiate<n>:CONTinuous](#) on page 589.

**Suffix:**

<n> [Window](#)

<li> [Limit line](#)

**Return values:**

<Result>           **0**  
                      PASS  
  
                      **1**  
                      FAIL

|                          |                                                                                                                                             |
|--------------------------|---------------------------------------------------------------------------------------------------------------------------------------------|
| <b>Example:</b>          | INIT;*WAI<br>Starts a new sweep and waits for its end.<br>CALC2:LIM3:FAIL?<br>Queries the result of the check for limit line 3 in window 2. |
| <b>Usage:</b>            | Query only                                                                                                                                  |
| <b>Manual operation:</b> | See " <a href="#">Limit Check &lt;n&gt;</a> " on page 312<br>See " <a href="#">Limit Check</a> " on page 342                                |

### Programming Example: Using Limit Lines

The following examples demonstrate how to work with limit lines in a remote environment.

- [Example: Configuring Limit Lines](#).....859
- [Example: Performing a Limit Check](#).....860

### Example: Configuring Limit Lines

This example demonstrates how to configure 2 limit lines - an upper and a lower limit - for a measurement in a remote environment.

```
//----- Configuing the limit lines -----
CALC:LIM1:NAME 'FM1'
//Names limit line 1 'FM1'.

CALC:LIM1:CONT:MODE ABS
//Selects absolute scaling for the horizontal axis.
CALC:LIM1:CONT 1 MHz,50MHz,100 MHz,150MHz,200MHz
//Defines 5 horizontal definition points for limit line 1.
CALC:LIM1:UPP:MODE ABS
//Selects an absolute vertical scale for limit line 1.
CALC:LIM1:UNIT DBM
//Selects the unit dBm for limit line 1.
CALC:LIM1:UPP -10,-5,0,-5,-10
//Defines 5 definition points for limit line 1.

CALC:LIM1:UPP:MARG 5dB
//Defines an area of 5 dB around limit line 1 where limit check violations
//are still tolerated.

CALC:LIM1:UPP:SHIF -10DB
//Shifts the limit line 1 by -10 dB.
CALC:LIM1:UPP:OFFS -3dB
//Defines an additional -3 dB offset for limit line 1.

CALC:LIM3:NAME 'FM3'
//Names limit line 3 'FM3'.

CALC:LIM3:LOW:MODE REL
//Selects a relative vertical scale for limit line 3.
```

## Setting Basic Spectrum RF Measurement Parameters

```

CALC:LIM3:UNIT DB

CALC:LIM3:CONT 1 MHz,50MHz,100 MHz,150MHz,200MHz
//Defines 5 horizontal definition points for limit line 3.
CALC:LIM3:LOW -90,-60,-40,-60,-90
//Defines 5 definition points relative to the reference level for limit line 3.

CALC:LIM3:LOW:SHIF 2
//Shifts the limit line 3 by 2dB.
CALC:LIM3:LOW:OFFS 3
//Defines an additional 3 dB offset for limit line 3.

CALC:LIM3:LOW:THR -200DBM
//Defines a power threshold of -200dBm that must be exceeded for limit to be checked

CALC:LIM3:LOW:MARG 5dB
//Defines an area of 5dB around limit line 3 where limit check violations
//are still tolerated.

//----- Storing the limit lines -----
MMEM:SEL:CHAN:LIN:ALL ON
MMEM:STOR:TYPE CHAN
MMEM:STOR:STAT 1,'LimitLines_FM1_FM3'

```

**Example: Performing a Limit Check**

This example demonstrates how to perform a limit check during a basic frequency sweep measurement in a remote environment. The limit lines configured in ["Example: Configuring Limit Lines"](#) on page 859 are assumed to exist and be active.

```

//-----Preparing the instrument -----
*RST
//Resets the instrument
INIT:CONT OFF
//Selects single sweep mode.

//-----Configuring the measurement -----
FREQ:CENT 100MHz
//Defines the center frequency
FREQ:SPAN 200MHz
//Sets the span to 100 MHz on either side of the center frequency.
SENS:SWE:COUN 10
//Defines 10 sweeps to be performed in each measurement.
DISP:TRAC1:Y:RLEV 0dBm
//Sets the reference level to 0 dBm.
TRIG:SOUR IFP
TRIG:LEV:IFP -10dBm
//Defines triggering when the second intermediate frequency rises to a level
//of -10 dBm.

//-----Configuring the Trace-----

```

```

DISP:TRAC2 ON
DISP:TRAC2:MODE AVER
DISP:TRAC3 ON
DISP:TRAC3:MODE MAXH
//Configures 3 traces: 1 (default): clear/write; 2: average; 3: max hold

//----- Configuring the limit check -----
MMEM:LOAD:TYPE REPL
MMEM:LOAD:STAT 1,'LimitLines_FM1_FM3'
//Loads the limit lines stored in 'LimitLines_FM1_FM3'
CALC:LIM1:NAME 'FM1'
CALC:LIM1:UPP:STAT ON
//Activates upper limit FM1 as line 1.
CALC:LIM3:NAME 'FM3'
CALC:LIM3:LOW:STAT ON
//Activates lower limit line FM3 as line 3.
CALC:LIM:ACT?
//Queries the names of all active limit lines
//Result: 'FM1,FM3'
CALC:LIM1:TRAC3:CHEC ON
//Activates the upper limit to be checked against trace3 (maxhold trace)
CALC:LIM3:TRAC2:CHEC ON
//Activates the upper limit to be checked against trace2 (average trace)
CALC:LIM:CLE
//Clears the previous limit check results

//----- Performing the measurement-----
INIT;*WAI
//Initiates a new measurement and waits until the last sweep has finished.

//----- Retrieving limit check results-----

CALC:LIM1:FAIL?
//Queries the result of the upper limit line check
CALC:LIM3:FAIL?
//Queries the result of the lower limit line check

```

## 9.9 Managing Settings and Results

The commands required to store and load instrument settings and import and export measurement results in a remote environment are described here.

### Addressing drives

The various drives can be addressed via the "mass storage instrument specifier" <msis> using the conventional Windows syntax. The internal hard disk is addressed by "C:".

For details on storage locations refer to ["Storage Location and Filename"](#) on page 107.

The file names (<FileName> parameter) are given as string parameters enclosed in quotation marks. They also comply with Windows conventions. Windows file names do not distinguish between uppercase and lowercase notation.

### Wildcards

The two characters "\*" and "?" can be used as "wildcards", i.e., they are variables for a selection of several files. The question mark "?" replaces exactly one character, the asterisk replaces any of the remaining characters in the file name. "\*.\*" thus means all files in a directory.

### Path names

Storage locations can be specified either as absolute (including the entire path) or relative paths (including only subfolders of the current folder). Use the `MMEM:CDIR?` query to determine the current folder.

- [General Data Storage and Loading Commands](#)..... 862
- [Selecting the Items to Store](#)..... 868
- [Storing and Loading Instrument Settings](#)..... 871
- [Storing or Printing Screenshots](#)..... 876
- [Storing Measurement Results](#)..... 886
- [Examples: Managing Data](#)..... 888

## 9.9.1 General Data Storage and Loading Commands

The following commands are available for all applications.

See also:

- [FORMat \[ :DATA \]](#) on page 776

|                                                     |     |
|-----------------------------------------------------|-----|
| <a href="#">FORMat:DEXPort:DSEPARATOR</a> .....     | 863 |
| <a href="#">MMEMory:CATalog</a> .....               | 863 |
| <a href="#">MMEMory:CATalog:LONG</a> .....          | 864 |
| <a href="#">MMEMory:CDIRectory</a> .....            | 864 |
| <a href="#">MMEMory:COMMeNt</a> .....               | 864 |
| <a href="#">MMEMory:COPIE</a> .....                 | 865 |
| <a href="#">MMEMory:DATA</a> .....                  | 865 |
| <a href="#">MMEMory:DELeTe[:IMMeDiate]</a> .....    | 866 |
| <a href="#">MMEMory:MDIRectory</a> .....            | 866 |
| <a href="#">MMEMory:MOVE</a> .....                  | 866 |
| <a href="#">MMEMory:MSIS</a> .....                  | 866 |
| <a href="#">MMEMory:NAME</a> .....                  | 866 |
| <a href="#">MMEMory:NETWork:DISConnect</a> .....    | 867 |
| <a href="#">MMEMory:NETWork:MAP</a> .....           | 867 |
| <a href="#">MMEMory:NETWork:UNUSeddrives?</a> ..... | 868 |
| <a href="#">MMEMory:NETWork:USEDdrives</a> .....    | 868 |
| <a href="#">MMEMory:RDIRectory</a> .....            | 868 |

**FORMat:DEXPort:DSEParator** <Separator>

This command selects the decimal separator for data exported in ASCII format.

**Parameters:**

&lt;Separator&gt;

POINT | COMMa

**COMMa**

Uses a comma as decimal separator, e.g. 4,05.

**POINT**

Uses a point as decimal separator, e.g. 4.05.

\*RST:        \*RST has no effect on the decimal separator.  
Default is POINT.

**Example:**

FORM:DEXP:DSEP POIN

Sets the decimal point as separator.

**Manual operation:**

See " [Decimal Separator](#) " on page 115

See " [Saving the Result Summary \(Evaluation List\) to a File](#) " on page 322

See " [Save Evaluation List](#) " on page 344

See " [Export Peak List](#) " on page 499

**MMEMory:CATalog** <Path>

This command returns the contents of a particular directory.

**Parameters:**

&lt;Path&gt;

String containing the path and directory

If you leave out the path, the command returns the contents of the directory selected with [MMEMory:CDIRectory](#) on page 864.

The path may be relative or absolute. Using wildcards ("\*") is possible to query a certain type of files only.

If you use a specific file as a parameter, the command returns the name of the file if the file is found in the specified directory, or an error if the file is not found ("-256, "File name not found").

**Return values:**

&lt;FileNames&gt;

List of file and directory names, separated by commas

If no files are found, an error is displayed: "-256, "File name not found"

**Example:**

MMEM:CAT? 'C:

\Users\Public\Documents\Rohde-Schwarz\Analyzer\user\SPOOL?

Returns all files in

C:\Users\Public\Documents\Rohde-Schwarz\Analyzer\user  
whose names start with SPOOL, have 6 letters and the extension .PNG, e.g.:

SPOOL1.PNG, SPOOL2.PNG, SPOOL3.PNG

- Example:** MMEM:CAT? 'C:  
 \Users\Public\Documents\Rohde-Schwarz\Analyzer\user\SPOOL6  
 Query whether the file 'SPOOL6.PNG' also exists in the directory;  
**Result:**  
 -256,"File name not found;:MMEMory:CATalog?  
 'C:\Users\Public\Documents\Rohde-Schwarz\Analyzer\user\SPOOL6.PNG'
- Manual operation:** See "[Selecting Storage Location - Drive/ Path/ Files](#)"  
 on page 108

---

### MMEMory:CATalog:LONG <Path>

This command returns the contents of a particular directory with additional information about the files.

**Parameters:**

- <Path> String containing the path and directory.  
 If you leave out the path, the command returns the contents of the directory selected with [MMEMory:CDIRectory](#) on page 864.  
 The path may be relative or absolute. Using wildcards ("\*") is possible to query a certain type of files only.

**Return values:**

- <UsedDiskSpace> Byte size of all files in the directory.  
 <FreeDiskSpace> Remaining disk space in bytes.  
 <FileInfo> <NameFileN>,<SuffixFileN>,<SizeFileN>  
 Describes the individual file.  
**<NameFileN>**  
 Name of the file.  
**<SuffixFileN>**  
 Type of the file. Possible suffixes are: ASCii, BINary, DIRectory, STAT  
**<SizeFileN>**  
 Size of the file in bytes.

---

### MMEMory:CDIRectory <Directory>

This command changes the current directory.

**Parameters:**

- <Directory> String containing the path to another directory.  
 The path may be relative or absolute.

---

### MMEMory:COMMeNT <Comment>

This command defines a comment for the stored settings.

**Parameters:**

- <Comment> String containing the comment.



**Example:** `MMEemory:COMMeNt "ACP measurement with Standard Tetra from 23.05."`  
`MMEemory::MMEemory:STORel:STATe 1, "ACP_T"`  
 As a result, in the selection list for recall settings, the comment "ACP measurement with Standard Tetra from 23.05." is added to the ACP entry.

**Manual operation:** See " [Comment](#) " on page 108

---

### **MMEemory:COpy** <SourceFile>, <DestinationFile>

This command copies one or more files to another directory.

**Parameters:**

<SourceFile> String containing the path and file name of the source file.  
 <DestinationFile> String containing the path and name of the target file.  
 The path may be relative or absolute.

---

### **MMEemory:DATA** <FileName>[, <Block>]

This command writes block data into a file. The delimiter must be set to EOI to obtain error-free data transfer.

When you query the contents of a file, you can save them in a file on the remote control computer.

The command is useful for reading stored settings files or trace data from the instrument or for transferring them to the instrument

**Parameters:**

<FileName> String containing the path and name of the target file.  
 <Block> <block\_data>  
 Data block with the following structure.  
 #  
 Hash sign.  
 <number>  
 Length of the length information.  
 <number>  
 Length information of the binary data (number of bytes).  
 <data>  
 Binary data with the indicated <number> of bytes.

**Example:** `MMEemory:NAME '\Public\User\Testfile.txt'`  
 Creates a new file called 'testfile.txt'.  
`MMEemory:DATA 'Testfile.txt',#220`Contents of the file  
 file  
 The parameter means:  
 #2: hash sign and length of the length information (20 bytes = 2 digits)  
 20: indicates the number of subsequent binary data bytes.  
 Contents of the file: store 20 binary bytes (characters) to the file.

---

**MMEMory:DELEte[:IMMediate]** <FileName>

This command deletes a file.

**Setting parameters:**

<FileName> String containing the path and file name of the file to delete.  
The path may be relative or absolute.

**Usage:** Setting only

---

**MMEMory:MDIRectory** <Directory>

This command creates a new directory.

**Setting parameters:**

<Directory> String containing the path and new directory name  
The path may be relative or absolute.

**Usage:** Setting only

---

**MMEMory:MOVE** <SourceFile>, <NewFileName>

This command moves a file to another directory.

The command also renames the file if you define a new name in the target directory.

If you do not include a path for <NewFileName>, the command just renames the file.

**Setting parameters:**

<SourceFile> String containing the path and file name of the source file.

<NewFileName> String containing the path and name of the target file.

**Example:** `MMEM:MOVE 'C:\TEST01.CFG', 'SETUP.CFG'`  
Renames TEST01.CFG in SETUP.CFG in directory C:\.

**Usage:** Setting only

---

**MMEMory:MSIS** <Device>

This command selects the default storage device used by all MMEMory commands.

**Parameters:**

<Device> 'A:' | 'C:' | ... | 'Z:'  
String containing the device drive name  
\*RST: n.a.

---

**MMEMory:NAME** <FileName>

This command has several purposes, depending on the context it is used in.

- It creates a new and empty file.
- It defines the file name for screenshots taken with `HCOPY[:IMMediate<device>]`. Note that you have to route the printer output to a file.

**Parameters:**

<FileName> String containing the path and name of the target file.

**Example:**

```
MMEM:NAME 'C:
\Users\Public\Documents\Rohde-Schwarz\Analyzer\user\PRINT1
Selects the file name.
```

---

**MMEMory:NETWork:DISConnect** <Drive>[, <Force>]

This command disconnects a network drive.

**Setting parameters:**

<Drive> String containing the drive name.

<Force> 1 | 0 | ON | OFF  
Optional: determines whether disconnection is forced or not

**1 | ON**  
Disconnection is forced.

**0 | OFF**  
Disconnect only if not in use.

\*RST: 0

**Usage:** Setting only

---

**MMEMory:NETWork:MAP** <Drive>, <HostName>[, <UserName>, <Password>, <Reconnect>]

This command maps a drive to a server or server directory of the network.

Note that you have to allow sharing for a server or folder in Microsoft networks first.

**Setting parameters:**

<Drive> String containing the drive name or path of the directory you want to map.

<HostName> String containing the host name of the computer or the IP address and the share name of the drive.  
'<host name or IP address>\share name>'

<UserName> String containing a user name in the network.  
The user name is optional.

<Password> String containing the password corresponding to the <User-Name>.  
The password is optional.

<Reconnect> ON | OFF | 1 | 0  
**ON | 1**  
Reconnects at logon with the same user name.  
**OFF | 0**  
Does not reconnect at logon.

**Usage:** Setting only

**MMEMory:NETWork:UNUSeddrives?**

This command returns a list of unused network drives.

**Return values:**

<DriveName> List of network drives in alphabetically descending order, e.g. 'W:,V:,U:,...'

**Usage:** Query only

**MMEMory:NETWork:USEDdrives [<State>]**

This command returns a list of all network drives in use.

**Parameters:**

<State> You do not have to use the parameter. If you do not include the parameter, the command returns a list of all drives in use. This is the same behavior as if you were using the parameter OFF.

**ON | 1**

Returns a list of all drives in use including the folder information.

**OFF | 0**

Returns a list of all drives in use.

**MMEMory:RDIRECTory <Directory>**

This command deletes the indicated directory.

**Setting parameters:**

<Directory> String containing the path of the directory to delete. Note that the directory you want to remove must be empty.

**Usage:** Setting only

**9.9.2 Selecting the Items to Store**

The following commands select the items to be included in the configuration file.

Depending on the used command, either the items from the entire instrument (MMEMory:SELEct[:ITEM]...), or only those from the currently selected channel setup (MMEM:SELEct:CHANnel[:ITEM]...) are stored.

|                                               |     |
|-----------------------------------------------|-----|
| MMEMory:SELEct:CHANnel[:ITEM]:ALL.....        | 869 |
| MMEMory:SELEct[:ITEM]:ALL.....                | 869 |
| MMEMory:SELEct:CHANnel[:ITEM]:DEFault.....    | 869 |
| MMEMory:SELEct[:ITEM]:DEFault.....            | 869 |
| MMEMory:SELEct:CHANnel[:ITEM]:HWSettings..... | 869 |
| MMEMory:SELEct[:ITEM]:HWSettings.....         | 869 |
| MMEMory:SELEct:CHANnel[:ITEM]:LINes:ALL.....  | 870 |
| MMEMory:SELEct[:ITEM]:LINes:ALL.....          | 870 |
| MMEMory:SELEct:CHANnel[:ITEM]:NONE.....       | 870 |
| MMEMory:SELEct[:ITEM]:NONE.....               | 870 |

|                                                                   |     |
|-------------------------------------------------------------------|-----|
| <code>MMEemory:SElect:CHANnel[:ITEM]:SPECtrogram</code> .....     | 870 |
| <code>MMEemory:SElect:CHANnel[:ITEM]:SGRam</code> .....           | 870 |
| <code>MMEemory:SElect[:ITEM]:SPECtrogram</code> .....             | 870 |
| <code>MMEemory:SElect[:ITEM]:SGRam</code> .....                   | 870 |
| <code>MMEemory:SElect:CHANnel[:ITEM]:TRACe[:ACTive]</code> .....  | 871 |
| <code>MMEemory:SElect[:ITEM]:TRACe&lt;t&gt;[:ACTive]</code> ..... | 871 |
| <code>MMEemory:SElect:CHANnel[:ITEM]:TRANsducer:ALL</code> .....  | 871 |
| <code>MMEemory:SElect[:ITEM]:TRANsducer:ALL</code> .....          | 871 |

---

### **MMEemory:SElect:CHANnel[:ITEM]:ALL**

#### **MMEemory:SElect[:ITEM]:ALL**

This command includes all items when storing or loading a configuration file.

The items are:

- Hardware configuration: `MMEemory:SElect[:ITEM]:HWSettings` on page 869
- Limit lines: `MMEemory:SElect[:ITEM]:LINES:ALL` on page 870
- Spectrogram data: `MMEemory:SElect[:ITEM]:SGRam` on page 870
- Trace data: `MMEemory:SElect[:ITEM]:TRACe<t>[:ACTive]` on page 871
- Transducers: `MMEemory:SElect[:ITEM]:TRANsducer:ALL` on page 871

**Example:** `MMEemory:SEL:ALL`

**Usage:** Event

**Manual operation:** See " [Items](#) " on page 108

---

### **MMEemory:SElect:CHANnel[:ITEM]:DEFault**

#### **MMEemory:SElect[:ITEM]:DEFault**

This command selects the current settings as the only item to store to and load from a configuration file.

**Usage:** Event

**Manual operation:** See " [Items](#) " on page 108

---

### **MMEemory:SElect:CHANnel[:ITEM]:HWSettings <State>**

#### **MMEemory:SElect[:ITEM]:HWSettings <State>**

This command includes or excludes measurement (hardware) settings when storing or loading a configuration file.

Measurement settings include:

- general channel configuration
- measurement hardware configuration including markers
- limit lines  
Note that a configuration may include no more than 8 limit lines. This number includes active limit lines as well as inactive limit lines that were used last.

Therefore the combination of inactivate limit lines depends on the sequence of use with `MMEMemory:LOAD:STATE` on page 873.

- color settings
- configuration for the hardcopy output

**Parameters:**

<State> ON | OFF | 0 | 1  
\*RST: 1

**Example:** MMEM:SEL:HWS ON

**Manual operation:** See " [Items:](#) " on page 108

**MMEMemory:SElect:CHANnel[:ITEM]:LINEs:ALL** <State>

**MMEMemory:SElect[:ITEM]:LINEs:ALL** <State>

This command includes or excludes all limit lines (active and inactive) when storing or loading a configuration file.

**Parameters:**

<State> ON | OFF | 1 | 0  
\*RST: 0

**Example:** MMEM:SEL:LIN:ALL ON

**Manual operation:** See " [Items:](#) " on page 108

**MMEMemory:SElect:CHANnel[:ITEM]:NONE**

**MMEMemory:SElect[:ITEM]:NONE**

This command does not include any of the following items when storing or loading a configuration file.

- Hardware configuration: `MMEMemory:SElect[:ITEM]:HWSettings` on page 869
- Limit lines: `MMEMemory:SElect[:ITEM]:LINEs:ALL` on page 870
- Spectrogram data: `MMEMemory:SElect[:ITEM]:SGRam` on page 870
- Trace data: `MMEMemory:SElect[:ITEM]:TRACe<t>[:ACTIVE]` on page 871
- Transducers: `MMEMemory:SElect[:ITEM]:TRANsducer:ALL` on page 871

**Example:** MMEM:SEL:NONE

**Usage:** Event

**Manual operation:** See " [Items:](#) " on page 108

**MMEMemory:SElect:CHANnel[:ITEM]:SPECTrogram** <State>

**MMEMemory:SElect:CHANnel[:ITEM]:SGRam** <State>

**MMEMemory:SElect[:ITEM]:SPECTrogram** <State>

**MMEMemory:SElect[:ITEM]:SGRam** <State>

This command includes or excludes spectrogram data when storing or loading a configuration file.

**Parameters:**

<State> ON | OFF | 1 | 0  
 \*RST: 0

**Example:**

MMEM:SEL:SGR ON  
 Adds the spectrogram data to the list of data subsets.

**Manual operation:** See " [Items](#):" on page 108

**MMEMory:SElect:CHANnel[:ITEM]:TRACe[:ACTive] <State>**  
**MMEMory:SElect[:ITEM]:TRACe<t>[:ACTive] <State>**

This command includes or excludes trace data when storing or loading a configuration file.

**Suffix:**

<t> irrelevant

**Parameters:**

<State> ON | OFF | 1 | 0  
 \*RST: 0, i.e. no traces are stored

**Example:**

MMEM:SEL:TRAC ON

**Manual operation:** See " [Items](#):" on page 108

**MMEMory:SElect:CHANnel[:ITEM]:TRANsducer:ALL <State>**  
**MMEMory:SElect[:ITEM]:TRANsducer:ALL <State>**

This command includes or excludes transducer factors when storing or loading a configuration file.

**Parameters:**

<State> ON | OFF | 1 | 0  
 \*RST: 0

**Example:**

MMEM:SEL:TRAN:ALL ON

**Manual operation:** See " [Items](#):" on page 108  
 See " [Save](#) " on page 158

### 9.9.3 Storing and Loading Instrument Settings

See also:

- [INSTrument\[:SElect\]](#) on page 583 to select the channel setup.

|                                                    |     |
|----------------------------------------------------|-----|
| <a href="#">MMEMory:CLEar:ALL</a> .....            | 872 |
| <a href="#">MMEMory:CLEar:STATe</a> .....          | 872 |
| <a href="#">MMEMory:LOAD:AUTO</a> .....            | 872 |
| <a href="#">MMEMory:LOAD:STATe</a> .....           | 873 |
| <a href="#">MMEMory:LOAD:TYPE</a> .....            | 874 |
| <a href="#">MMEMory:STORe&lt;n&gt;:STATe</a> ..... | 874 |

|                                   |     |
|-----------------------------------|-----|
| MMEMory:STORe<n>:STATe:NEXt.....  | 875 |
| MMEMory:STORe<n>:TYPE.....        | 875 |
| SYSTem:PRESet.....                | 875 |
| SYSTem:PRESet:CHANnel[:EXEC]..... | 876 |

---

### MMEMory:CLEAr:ALL

This command deletes all instrument configuration files in the current directory.

You can select the directory with [MMEMory:CDIRectory](#) on page 864.

**Example:**               MMEM:CLE:ALL

**Usage:**                Event

---

### MMEMory:CLEAr:STATe <1>, <FileName>

This command deletes an instrument configuration file.

#### Setting parameters:

<1>

<FileName>               String containing the path and name of the file to delete.  
The string may or may not contain the file's extension.

**Example:**               MMEM:CLE:STAT 1, 'TEST'

**Usage:**                Setting only

---

### MMEMory:LOAD:AUTO <1>, <FactoryFileName>

This command restores an instrument configuration and defines that configuration as the default state.

The default state is restored after a preset (*\*RST*) or after you turn on the R&S FPL1000.

#### Setting parameters:

<1>

<FactoryFileName>       **'Factory'**  
Restores the factory settings as the default state.

#### '<file\_name>

String containing the path and name of the configuration file.  
Note that only *instrument* settings files can be selected for the startup recall function; channel setup files cause an error.

**Example:**               MMEM:LOAD:AUTO 1, 'C:  
                          \Users\Public\Documents\Rohde-Schwarz\Analyzer\user\TEST'

**Usage:**                Setting only

**Manual operation:**    See "[Startup Recall](#)" on page 110



**MMEMemory:LOAD:STATE** <1>, <FileName>

This command restores and activates the instrument configuration stored in a \*.dfl file.

Note that files with other formats cannot be loaded with this command.

The contents that are reloaded from the file are defined by the last selection made either in the "Save/Recall" dialogs (manual operation) or through the `MMEMemory:SElect[:ITEM]` commands (remote operation; the settings are identical in both cases).

By default, the selection is limited to the user settings ("User Settings" selection in the dialogs, `HWSettings` in SCPI). The selection is not reset by `[Preset]` or `*RST`.

As a consequence, the results of a SCPI script using the `MMEMemory:LOAD:STATE` command without a previous `MMEMemory:SElect[:ITEM]` command may vary, depending on previous actions in the GUI or in previous scripts, even if the script starts with the `*RST` command.

It is therefore recommended that you use the appropriate `MMEMemory:SElect[:ITEM]` command before using `MMEMemory:LOAD:STATE`.

**Parameters:**

<1>

<FileName> String containing the path and name of the file to load.  
The string may or may not include the file's extension.

**Example:**

```
MMEM:SEL:ALL
//Save all items (User Settings, All Traces, All Limit Lines) from
the R&S FPL1000.
MME:LOAD:STAT 1, 'C:
\Users\Public\Documents\Rohde-Schwarz\Analyzer\user\TEST01
//Reloads all items
In the "Recall" dialog, select only "User Settings" and "All Limit
Lines".
MME:LOAD:STAT 1, 'C:
\Users\Public\Documents\Rohde-Schwarz\Analyzer\user\TEST01
//Reloads user settings and all limit lines.
*RST
//Reset instrument.
MME:LOAD:STAT 1, 'C:
\Users\Public\Documents\Rohde-Schwarz\Analyzer\user\TEST01
//Selected items are retained. Reloads user settings and all limit
lines.
Restart the instrument.
(Switch the [ON/OFF] key off and on).
MME:LOAD:STAT 1, 'C:
\Users\Public\Documents\Rohde-Schwarz\Analyzer\user\TEST01
// Selected items are set to default. Reloads only the user set-
tings.
```

**Manual operation:** See " [Recall](#) " on page 106  
See " [Recall in New Channel / Recall in Current Channel](#) " on page 109

---

### MMEMory:LOAD:TYPE <Mode>

This command defines whether the channel setups that will be loaded with the subsequent `MMEM:LOAD:STAT` command will replace the current channel setup or activate a new channel setup.

#### Parameters:

<Mode> NEW | REPLace

#### **NEW**

The loaded settings will be activated in a new channel setup.

#### **REPLace**

The loaded settings will replace the currently active channel setup.

\*RST: NEW

#### Example:

```
INST:SEL 'SPECTRUM2'
//Selects channel setup 'SPECTRUM2'.
MMEM:STOR:TYP CHAN
//Specifies that channel setup data is to be stored.
MMEM:STOR:STAT 1, 'C:\Users\Public\Documents\Rohde-Schwarz\Analyzer\user\
//Stores the settings from channel setup
//'SPECTRUM2' to the file 'C:\Users\Public\Documents\Rohde-Schwarz\Analyz
MMEM:LOAD:TYPE NEW
//Specifies that channel setups are to be loaded
//in a new channel setup.
MMEM:LOAD:STAT 1, 'C:\Users\Public\Documents\Rohde-Schwarz\Analyzer\user\
//Loads the channel setup from the file
//'C:\Users\Public\Documents\Rohde-Schwarz\Analyzer\user\Spectrum' to the
//'SPECTRUM2*'.

```

---

### MMEMory:STORe<n>:STATe <1>, <FileName>

This command saves the current instrument configuration in a \*.df1 file.

#### Suffix:

<n> irrelevant

#### Setting parameters:

<1>

<FileName> String containing the path and name of the target file.  
The file extension is .df1.

#### Example:

```
MMEM:STOR:STAT 1, 'Save'
Saves the current instrument settings in the file Save.dfl.
```

#### Usage:

Setting only

**Manual operation:** See " [Save File](#) " on page 109  
See " [Save](#) " on page 158

---

### MMEMory:STORe<n>:STATe:NEXT

This command saves the current instrument configuration in a \*.df1 file.

The file name depends on the one you have set with `MMEMory:STORe<n>:STATe` on page 874. This command adds a consecutive number to the file name.

**Suffix:**

<n> irrelevant

**Example:**

```
MMEM:STOR:STAT 1, 'Save'
```

Saves the current instrument settings in the file `Save.df1`.

```
MMEM:STOR:STAT:NEXT
```

Saves the current instrument settings in the file `Save_001.df1`

```
MMEM:STOR:STAT:NEXT
```

Saves the current instrument settings in the file `Save_002.df1`

**Manual operation:** See " [Save File](#) " on page 109

---

### MMEMory:STORe<n>:TYPE <Mode>

This command defines whether the data from the entire instrument or only from the current channel setup is stored with the subsequent `MMEM:STOR...` command.

**Suffix:**

<n> irrelevant

**Parameters:**

<Mode> INSTRument | CHANnel

**INSTRument**

Stores data from the entire instrument.

**CHANnel**

Stores data from an individual channel setup.

```
*RST: INST
```

**Example:**

```
INST:SEL 'SPECTRUM2'
```

Selects channel setup 'SPECTRUM2'.

```
MMEM:STOR:TYPE CHAN
```

Specifies that channel setup data is to be stored.

---

### SYSTem:PRESet

This command presets the R&S FPL1000. It is identical to `*RST`.

**Example:**

```
SYST:PRES
```

**Usage:**

Event

**SYSTem:PRESet:CHANnel[:EXEC]**

This command restores the default instrument settings in the current channel setup.

Use `INST:SEL` to select the channel setup.

For details see [Chapter 7.2.1, "Restoring the Default Instrument Configuration \(Preset\)"](#), on page 102.

**Example:**            `INST:SEL 'Spectrum2'`  
                               Selects the channel setup for "Spectrum2".  
                               `SYST:PRESet:CHAN:EXEC`  
                               Restores the factory default settings to the "Spectrum2" channel setup.

**Usage:**                Event

**Manual operation:** See "[Preset Channel Setup](#)" on page 238

**9.9.4 Storing or Printing Screenshots****Useful commands to configure screenshots described elsewhere**

- [MMEMory:NAME](#) on page 866

**Remote commands exclusive to configuring screenshots**

|                                                                |     |
|----------------------------------------------------------------|-----|
| <a href="#">DISPlay:LOGO</a> .....                             | 877 |
| <a href="#">HCOPy:ABORT</a> .....                              | 877 |
| <a href="#">HCOPy:CONTeNt</a> .....                            | 877 |
| <a href="#">HCOPy:CMAP&lt;it&gt;:DEFault&lt;ci&gt;</a> .....   | 878 |
| <a href="#">HCOPy:DES TINation&lt;device&gt;</a> .....         | 878 |
| <a href="#">HCOPy:DEVIce:COLor</a> .....                       | 879 |
| <a href="#">HCOPy:DEVIce:LANGUage&lt;device&gt;</a> .....      | 879 |
| <a href="#">HCOPy[:IMMEdiate&lt;device&gt;]</a> .....          | 880 |
| <a href="#">HCOPy[:IMMEdiate&lt;device&gt;]:NEXT</a> .....     | 880 |
| <a href="#">HCOPy:ITEM:WINDow&lt;n&gt;:TEXT</a> .....          | 880 |
| <a href="#">HCOPy:PAGE:COUNT:STATe</a> .....                   | 880 |
| <a href="#">HCOPy:PAGE:MARGIn&lt;device&gt;:BOTTom</a> .....   | 881 |
| <a href="#">HCOPy:PAGE:MARGIn&lt;device&gt;:LEFT</a> .....     | 881 |
| <a href="#">HCOPy:PAGE:MARGIn&lt;device&gt;:RIGHT</a> .....    | 881 |
| <a href="#">HCOPy:PAGE:MARGIn&lt;device&gt;:TOP</a> .....      | 882 |
| <a href="#">HCOPy:PAGE:MARGIn&lt;device&gt;:UNIT</a> .....     | 882 |
| <a href="#">HCOPy:PAGE:ORientation&lt;device&gt;</a> .....     | 882 |
| <a href="#">HCOPy:PAGE:WINDow&lt;n&gt;:CHANnel:STATe</a> ..... | 883 |
| <a href="#">HCOPy:PAGE:WINDow&lt;n&gt;:COUNT</a> .....         | 883 |
| <a href="#">HCOPy:PAGE:WINDow&lt;n&gt;:SCALE</a> .....         | 884 |
| <a href="#">HCOPy:PAGE:WINDow&lt;n&gt;:STATe</a> .....         | 884 |
| <a href="#">HCOPy:TDS TAMP:STATe&lt;device&gt;</a> .....       | 885 |

|                                                   |     |
|---------------------------------------------------|-----|
| SYSTem:COMMunicate:PRINter:ENUMerate:FIRSt?.....  | 885 |
| SYSTem:COMMunicate:PRINter:ENUMerate[:NEXT]?..... | 885 |
| SYSTem:COMMunicate:PRINter:SELect<device>.....    | 886 |

---

### DISPlay:LOGO <State>

Activates/deactivates the printout of the Rohde & Schwarz company logo at the top of each page.

#### Parameters:

<State>                    1 | 0 | ON | OFF  
                               **1 | ON**  
                               Logo is printed.  
                               **0 | OFF**  
                               Logo is not printed.  
                               \*RST:        1

**Example:**                DISP:LOGO OFF

**Manual operation:**    See " [Print Logo](#) " on page 118

---

### HCOPy:ABORt

This command aborts a running hardcopy output.

**Example:**                HCOP:ABOR

**Usage:**                 Event

---

### HCOPy:CONTent <ContType>

This command determines the type of content included in the printout.

#### Parameters:

<ContType>                WINDows | HCOPy

#### **WINDows**

Includes only the selected windows in the printout. All currently active windows for the current channel setup (or "MultiView") are available for selection. How many windows are printed on each page of the printout is defined by [HCOPy:PAGE:WINDow<n>:COUNT](#) on page 883.

This option is not available when copying to the clipboard ([HCOP:DEST 'SYST:COMM:CLIP'](#) or an image file (see [HCOPy:DEvice:LANGuage<device>](#) on page 879).

If the destination is currently set to an image file or the clipboard, it is automatically changed to be a PDF file.

**HCOPY**

Selects all measurement results displayed on the screen for the current channel setup (or "MultiView"): diagrams, traces, markers, marker lists, limit lines, etc., including the channel setup bar and status bar, for printout on a single page. Displayed items belonging to the software user interface (e.g. softkeys) are not included. The size and position of the elements in the printout is identical to the screen display.

\*RST:        HCOpy

**Example:**

```
HCOP:DEST1 'SYST:COMM:CLIP'
HCOP:CONT WIND
HCOP:DEST1?
//Result: 'MME'
HCOP:DEV:LANG1?
//Result: 'PDF'
```

"Print to clipboard" is automatically switched to "print to PDF file" when the contents are switched to "multiple windows".

**Manual operation:** See "[Print Screenshot](#)" on page 118  
See "[Print Multiple Windows](#)" on page 118

**HCOPY:CMAP<it>:DEFault<ci>**

This command defines the color scheme for print jobs.

**Suffix:**

<it>                Irrelevant.

<ci>                See table below

**Example:**

```
HCOP:CMAP:DEF2
```

Selects the optimized color set for the color settings of a printout.

**Manual operation:** See "[Print Colors](#)" on page 137

| Gui setting                  | Description                                                                                                                                                                                                                                                   | Remote command |
|------------------------------|---------------------------------------------------------------------------------------------------------------------------------------------------------------------------------------------------------------------------------------------------------------|----------------|
| "Screen Colors (Print)"      | Selects the current screen colors for the printout. The background is always printed in white and the grid in black.                                                                                                                                          | HCOP:CMAP:DEF1 |
| "Optimized Colors"           | Selects an optimized color setting for the printout to improve the visibility of the colors (default setting). Trace 1 is blue, trace 2 black, trace 3 green, and the markers are turquoise. The background is always printed in white and the grid in black. | HCOP:CMAP:DEF2 |
| "Screen Colors (Screenshot)" | Selects the current screen colors without any changes for a screenshot.                                                                                                                                                                                       | HCOP:CMAP:DEF4 |

**HCOPY:DESTination<device> <Destination>**

This command selects the destination of a print job.

**Suffix:**  
 <device> Irrelevant.

**Setting parameters:**  
 <Destination> **'MMEM'**  
 Sends the hardcopy to a file.  
 You can select the file name with `MMEMory:NAME`.  
 You can select the file format with `HCOPY:DEVIce:LANGUage<device>`.

**'SYST:COMM:PRIN'**  
 Sends the hardcopy to a printer.  
 You can select the printer with `SYSTEM:COMMunicate:PRINter:SElect<device>`.

**'SYST:COMM:CLIP'**  
 Sends the hardcopy to the clipboard.  
 The format should be WEMF.  
 \*RST: 'SYST:COMM:CLIP'

**Usage:** Setting only

**Manual operation:** See " [Destination](#) " on page 121

---

#### HCOPY:DEVIce:COLor <State>

This command turns color printing on and off.

**Parameters:**  
 <State> ON | OFF | 0 | 1  
**ON | 1**  
 Color printing  
**OFF | 0**  
 Black and white printing  
 \*RST: 1

**Example:** `HCOPY:DEV:COL ON`

---

#### HCOPY:DEVIce:LANGUage<device> <Format>

This command selects the file format for a print job.

**Suffix:**  
 <device> 1 | 2  
 Irrelevant.

**Parameters:**  
 <Format> WMF | GDI | EWMF | BMP | PNG | JPEG | JPG | PDF | SVG |  
 DOC | RTF

**GDI**

Graphics Device Interface

Default format for output to a printer configured under Windows. Must be selected for output to the printer interface.

Can be used for output to a file. The printer driver configured under Windows is used to generate a printer-specific file format.

**BMP, JPG, PNG**

Data format for output to files only.

**Example:** HCOP:DEV:LANG1 PNG**Manual operation:** See " [Destination](#) " on page 121**HCOPy[:IMMEDIATE<device>]**

This command initiates a print job.

If you are printing to a file, the file name depends on [MMEMory:NAME](#).**Suffix:**

&lt;device&gt; Irrelevant.

**Manual operation:** See " [Print](#) " on page 120**HCOPy[:IMMEDIATE<device>]:NEXT**

This command initiates a print job.

If you are printing to a file, the file name depends on [MMEMory:NAME](#). This command adds a consecutive number to the file name.**Suffix:**

&lt;device&gt; Irrelevant. Suffix 2 is not allowed

**Manual operation:** See " [Print](#) " on page 120**HCOPY:ITEM:WINDow<n>:TEXT <Comment>**

This command defines a comment to be added to the printout.

**Suffix:**

&lt;n&gt; 1..n

**Parameters:**

&lt;Comment&gt; String containing the comment.

**Manual operation:** See " [Comment](#) " on page 118**HCOPY:PAGE:COUNT:STATe <State>**This command includes or excludes the page number for printouts consisting of multiple pages ([HCOPY:CONTent](#) on page 877).**Parameters:**

&lt;State&gt; 1 | 0 | ON | OFF



**1 | ON**

The page number is printed.

**0 | OFF**

The page number is not printed.

**\*RST:** 1**Example:** HCOP:PAGE:COUN:STAT ON**Manual operation:** See " [Print Page Count](#) " on page 118**HCOPy:PAGE:MARGin<device>:BOTTom <Margin>**

This command defines the margin at the bottom of the printout page on which no elements are printed. The margins are defined according to [HCOPy:PAGE:MARGin<device>:UNIT](#) on page 882.

**Suffix:**

<device> 1 | 2  
Irrelevant.

**Parameters:**

<Margin> \*RST: 4.23 mm

**Example:** HCOP:PAGE:MARG2:BOT 2**Manual operation:** See " [Margins](#) " on page 124**HCOPy:PAGE:MARGin<device>:LEFT <Margin>**

This command defines the margin at the left side of the printout page on which no elements are printed. The margins are defined according to [HCOPy:PAGE:MARGin<device>:UNIT](#) on page 882.

**Suffix:**

<device> 1 | 2  
Irrelevant.

**Parameters:**

<Margin> \*RST: 4.23 mm

**Example:** HCOP:PAGE:MARG2:LEFT 2**Manual operation:** See " [Margins](#) " on page 124**HCOPy:PAGE:MARGin<device>:RIGHT <Margin>**

This command defines the margin at the right side of the printout page on which no elements are printed. The margins are defined according to [HCOPy:PAGE:MARGin<device>:UNIT](#) on page 882.

**Suffix:**

<device> 1 | 2  
Irrelevant.

**Parameters:**

<Margin> \*RST: 4.23 mm

**Example:**

HCOPY:PAGE:MARG2:RIGH 2

**Manual operation:** See " Margins " on page 124

**HCOPY:PAGE:MARGin<device>:TOP <Margin>**

This command defines the margin at the top of the printout page on which no elements are printed. The margins are defined according to [HCOPY:PAGE:MARGin<device>:UNIT](#) on page 882.

**Suffix:**

<device> 1 | 2  
Irrelevant.

**Parameters:**

<Margin> \*RST: 4.23 mm

**Example:**

HCOPY:PAGE:MARG2:TOP 2

**Manual operation:** See " Margins " on page 124

**HCOPY:PAGE:MARGin<device>:UNIT <Unit>**

This command defines the unit in which the margins for the printout page are configured.

**Suffix:**

<device> 1 | 2  
Irrelevant.

**Parameters:**

<Unit> MM | IN  
**MM**  
millimeters  
**IN**  
inches  
\*RST: MM

**Example:**

HCOPY:PAGE:MARG2:BOTT 2

**Manual operation:** See " Margins " on page 124

**HCOPY:PAGE:ORientation<device> <Orientation>**

The command selects the page orientation of the printout.

The command is only available if the output device is a printer or a PDF file.

**Suffix:**

<device> 1 | 2  
Irrelevant.

**Parameters:**

<Orientation> LANDscape | PORTrait  
 \*RST: PORTrait

**Example:**

HCOP:DEV:LANG1 PDF  
 HCOP:PAGE:ORI2 LAND

**Manual operation:** See " [Orientation](#) " on page 123

**HCOPY:PAGE:WINDow<n>:CHANnel:STATe <ChannelName>, <State>**

This command selects all windows of the specified channel setup to be included in the printout for [HCOPY:CONTent](#) on page 877.

**Suffix:**

<n> irrelevant

**Parameters:**

<ChannelName> String containing the name of the channel setup.  
 For a list of available channel setup types use [INSTRUMENT:LIST?](#) on page 581.

<State> 1 | 0 | ON | OFF

**1 | ON**

The channel setup windows are included in the printout.

**0 | OFF**

The channel setup windows are not included in the printout.

\*RST: 1

**Example:**

HCOP:CONT WIND  
 HCOP:PAGE:WIND2:CHAN 'IQ Analyzer',0  
 HCOP:PAGE:WIND2:STAT 'IQ Analyzer','1',1  
 Prints only window 1 in the IQ Analyzer channel setup.

**Manual operation:** See " [Print Multiple Windows](#) " on page 118

**HCOPY:PAGE:WINDow<n>:COUNT <WinPerPage>**

This command defines how many windows are displayed on a single page of the printout for [HCOPY:CONTent](#) on page 877.

**Suffix:**

<n> irrelevant

**Parameters:**

<WinPerPage> integer

\*RST: 1

**Example:**

HCOP:PAGE:WIND2:COUNT 2

**Manual operation:** See " [Windows Per Page](#) " on page 123

**HCOPY:PAGE:WINDow<n>:SCALe <Mode>**

This command determines the scaling of the windows in the printout for [HCOPY:CONTent](#) on page 877.

**Suffix:**

<n> irrelevant

**Parameters:**

<Mode> 1 | 0 | ON | OFF

**1 | ON**

Each window is scaled to fit the page size optimally, not regarding the aspect ratio of the original display. If more than one window is printed on one page (see [HCOPY:PAGE:WINDow<n>:COUNT](#) on page 883), each window is printed in equal size. ("Size to fit")

**0 | OFF**

Each window is printed as large as possible while maintaining the aspect ratio of the original display. ("Maintain aspect ratio")

\*RST: 1

**Example:** `HCOPY:PAGE:WIND2:SCAL 0`

**Manual operation:** See " [Scaling](#) " on page 124

**HCOPY:PAGE:WINDow<n>:STATe <ChannelName>, <WindowName>, <State>**

This command selects the windows to be included in the printout for [HCOPY:CONTent](#) on page 877.

**Suffix:**

<n> irrelevant

**Parameters:**

<ChannelName> String containing the name of the channel setup. For a list of available channel setup types use [INSTrument:LIST?](#) on page 581.

<WindowName> String containing the name of the existing window. By default, the name of a window is the same as its index. To determine the name and index of all active windows in the active channel setup, use the [LAYout:CATalog\[:WINDow\]?](#) query.

<State> 1 | 0 | ON | OFF

**1 | ON**

The window is included in the printout.

**0 | OFF**

The window is not included in the printout.

\*RST: 1

**Example:** `HCOPY:PAGE:WIND2:STAT 'IQ Analyzer','1',1`

**Manual operation:** See " [Print Multiple Windows](#) " on page 118

---

#### HCOPy:TDSTamp:STATe<device> <State>

This command includes or excludes the time and date in the printout.

**Suffix:**

<device>            1 | 2  
Irrelevant.

**Parameters:**

<State>            1 | 0 | ON | OFF  
**1 | ON**  
The time and date are printed.  
**0 | OFF**  
The time and date are not printed.  
\*RST:            1

**Manual operation:** See " [Print Date and Time](#) " on page 119

---

#### SYSTem:COMMunicate:PRINter:ENUMerate:FIRSt?

This command queries the name of the first available printer.

To query the name of other installed printers, use [SYSTem:COMMunicate:PRINter:ENUMerate\[:NEXT\]?](#) on page 885.

**Return values:**

<PrinterName>    <char\_data>  
String containing the name of the first printer as defined in Windows.  
If the command cannot find a printer, it returns an empty string (' ').

**Usage:**            Query only

**Manual operation:** See " [Printer Name](#) " on page 122

---

#### SYSTem:COMMunicate:PRINter:ENUMerate[:NEXT]?

This command queries the name of available printers.

You have to use [SYSTem:COMMunicate:PRINter:ENUMerate:FIRSt?](#) on page 885 for this command to work properly.

**Return values:**

<PrinterName>    <char\_data>  
String containing the name of one printer as defined in Windows.  
To get a complete list of printers you have to send this query several times until no more printers could be found. In that case, the return value is an empty string (' '). Further queries after the empty string result in an error.

**Usage:** Query only  
**Manual operation:** See " [Printer Name](#) " on page 122

---

**SYSTem:COMMunicate:PRINter:SElect<device>** <PrinterName>

This command selects the printer that processes jobs sent by the R&S FPL1000.

Use [HCOPY:DESTination<device>](#) to select another output destination.

**Suffix:**  
 <device> 1 | 2  
 Irrelevant.

**Parameters:**  
 <PrinterName> String containing the printer name.  
 Use

- [SYSTem:COMMunicate:PRINter:ENUMerate:FIRSt?](#) on page 885 and
- [SYSTem:COMMunicate:PRINter:ENUMerate\[:NEXT\]?](#) on page 885 to query all available printers.

\*RST: NONE

**Manual operation:** See " [Printer Name](#) " on page 122

### 9.9.5 Storing Measurement Results

The following commands can be used to store the results of a measurement.

Useful commands for storing results described elsewhere:

- [FORMat\[:DATA\]](#) on page 776

**Remote commands exclusive to storing results:**

|                                                          |     |
|----------------------------------------------------------|-----|
| <a href="#">FORMat:DEXPort:HEADer</a> .....              | 886 |
| <a href="#">MMEMory:STORe&lt;n&gt;:LIST</a> .....        | 887 |
| <a href="#">MMEMory:STORe&lt;n&gt;:PEAK</a> .....        | 887 |
| <a href="#">MMEMory:STORe&lt;n&gt;:SGRam</a> .....       | 887 |
| <a href="#">MMEMory:STORe&lt;n&gt;:SPECTrogram</a> ..... | 887 |
| <a href="#">MMEMory:STORe&lt;n&gt;:SPURious</a> .....    | 888 |

---

**FORMat:DEXPort:HEADer** <State>

If enabled, additional instrument and measurement settings are included in the header of the export file for result data. If disabled, only the pure result data from the selected traces and tables is exported.

See [Chapter 8.13.6, "Reference: ASCII File Export Format"](#), on page 568 for details.

**Parameters:**

<State> ON | OFF | 0 | 1  
 \*RST: 1

**Manual operation:** See "[Include Instrument & Measurement Settings](#)" on page 564

**MMEMory:STORe<n>:LIST <FileName>**

This command exports the SEM and spurious emission list evaluation to a file.

The file format is \*.dat.

**Suffix:**

<n> [Window](#)

**Parameters:**

<FileName> String containing the path and name of the target file.

**Example:**

```
MMEM:STOR:LIST 'test'
```

Stores the current list evaluation results in the test.dat file.

**Manual operation:** See "[Saving the Result Summary \(Evaluation List\) to a File](#)" on page 322  
 See "[Save Evaluation List](#)" on page 344

**MMEMory:STORe<n>:PEAK <FileName>**

This command exports the marker peak list to a file.

**Suffix:**

<n> [Window](#)

**Parameters:**

<FileName> String containing the path, name and extension of the target file.

**Example:**

```
MMEM:STOR:PEAK 'test.dat'
```

Saves the current marker peak list in the file test.dat.

**Manual operation:** See "[Export Peak List](#)" on page 499

**MMEMory:STORe<n>:SGRam <FileName>****MMEMory:STORe<n>:SPECtrogram <FileName>**

This command exports spectrogram data to an ASCII file.

The file contains the data for every frame in the history buffer. The data corresponding to a particular frame begins with information about the frame number and the time that frame was recorded.

Note that, depending on the size of the history buffer, the process of exporting the data can take a while.

**Suffix:**

<n> [Window](#)

**Parameters:**

<FileName> String containing the path and name of the target file.

**Example:**

MMEM:STOR:SGR 'Spectrogram'  
Copies the spectrogram data to a file.

**Manual operation:** See " [Export Trace to ASCII File](#) " on page 114

**MMEMemory:STORe<n>:SPURious <FileName>**

This command exports the marker peak list available for spurious emission measurements to a file.

**Suffix:**

<n> irrelevant

**Parameters:**

<FileName> String containing the path and name of the target file.

**Example:**

MMEM:STOR:SPUR 'test'  
Saves the current marker peak list in the file test.dat.

## 9.9.6 Examples: Managing Data

- [Storing Data](#)..... 888
- [Loading Data](#)..... 889
- [Storing Instrument Settings](#)..... 889
- [Loading Instrument Settings](#)..... 890

### 9.9.6.1 Storing Data

```
MMEM:MSIS 'C:'
//Selects drive C: as the default storage device.

//-----Connecting a network drive-----
MMEM:NETW:USED?
//Returns a list of all drives in use in the network.
MMEM:NETW:UNUS?
//Returns a list of free drive names in the network.
MMEM:NETW:MAP 'Q:', 'Server\ACLRTesT'
//Maps drive Q: to the directory 'Server\ACLRTesT'

//-----Saving data on the instrument-----
MMEM:MDIR 'C:\R_S\INSTR\USER\Results'
//Creates a directory called 'Results' on drive C:
MMEM:NAME 'C:\R_S\INSTR\USER\Results\Test001.txt'
//Defines a file called 'Test001.txt'
MMEM:COMM 'ACLRTesT results'
//Creates a comment for the settings to be displayed in gui.
MMEM:DATA 'Test001.txt', #212FileContents
//Creates the file 'Test001.txt' and writes 12 characters to it
```



```
//-----Copying the data to another location---
MMEM:COPY 'C:\R_S\INSTR\USER\Results\Test001.txt','Q:'
//Copies the specified file to network drive Q:.
MMEM:DEL 'C:\R_S\INSTR\USER\Results\Test001.txt'
//Deletes the specified file from the instrument hard disk.
//or
//MMEM:MOVE 'C:\R_S\INSTR\USER\Results\Test001.xml','Q:\TestResults.txt'//
//Moves the file 'Test001.txt' to drive Q:, renames it to 'Testresults.txt'
//and removes it from the instrument hard disk.
MMEM:RDIR 'C:\R_S\INSTR\USER\Results'
//Deletes the directory called 'Results' from drive C:, unless it still
//contains any content.

//-----Disconnecting the network drive---
MMEM:NETW:DISC 'Q:'
//Disconnect drive Q:.
```

### 9.9.6.2 Loading Data

```
MMEM:CDIR?
//Returns the path of the current directory.
//e.g.
C:\R_S\Instr\user\
MMEM:CDIR 'C:\R_S\INSTR\USER\Results'
//Changes the current directory.
MMEM:CAT? 'C:\R_S\INSTR\USER\Results*.xml'
//or
MMEM:CAT? '*.xml'
//Returns a list of all xml files in the directory 'C:\R_S\INSTR\USER\Results'.
MMEM:CAT:LONG? '*.xml'
//Returns additional information about the xml files in the directory
// 'C:\R_S\INSTR\USER\Results'.
```

### 9.9.6.3 Storing Instrument Settings

In this example we will store the instrument settings for the "Spectrum" channel setup.

```
INST:SEL 'SPECTRUM'
//Selects measurement channel 'SPECTRUM'.
MEMM:STOR:TYPE CHAN
//Specifies that channel-specific data is to be stored.
MMEM:STOR:STAT 1, 'C:\R_S\Instr\user\Spectrum'
//Stores the channel settings from the 'Spectrum' channel
// to the file 'Spectrum.dfl'.
```

### 9.9.6.4 Loading Instrument Settings

In this example we will load the hardware settings from the configuration file `Spectrum.dfl` to a new "Spectrum2" channel setup.

```
MEMM:LOAD:TYPE NEW
//Specifies that settings will be loaded to a new channel besides the existing
//'Spectrum' channel.
MEMM:SEL:CHAN:HWS ON
//Selects only hardware settings to be loaded.
MEMM:LOAD:STAT 1, 'C:\R_S\Instr\user\Spectrum'
//Loads the channel-specific settings from the file 'C:\R_S\Instr\user\Spectrum.dfl'
//to a new channel. The new channel is named 'Spectrum2' to avoid a naming conflict
//with the existing 'Spectrum' channel.
INST:REN 'Spectrum2','Spectrum3'
//Renames the loaded channel to 'Spectrum3'.
```

## 9.10 Configuring the R&S FPL1000

The remote commands required to set up the R&S FPL1000 are described here.

- [Configuring the Reference Frequency](#)..... 890
- [Calibration and Checks](#)..... 891
- [Working with Transducers](#)..... 895
- [Customizing the Screen Layout](#)..... 899
- [Remote Commands for Language Settings](#)..... 903
- [Configuring the Network and Remote Control](#)..... 904
- [Checking the System Configuration](#)..... 908
- [Using Service Functions](#)..... 912

### 9.10.1 Configuring the Reference Frequency

[\[SENSe:\]ROSCillator:O100](#)..... 890  
[\[SENSe:\]ROSCillator:SOURce](#)..... 890

---

**[SENSe:]ROSCillator:O100 <State>**

---

**[SENSe:]ROSCillator:SOURce <Source>**

This command selects the reference oscillator.

If you want to select the external reference, it must be connected to the R&S FPL1000.

**Parameters:**

<Source>

**INTernal**

The internal reference is used (10 MHz)

**EXtErnal**

The external reference from the "REF INPUT 10 MHZ" connector is used; if none is available, an error flag is displayed in the status bar

**Example:**           ROSC:SOUR EXT

**9.10.2 Calibration and Checks**

The following commands control calibration and checks on the R&S FPL1000.

|                                                  |     |
|--------------------------------------------------|-----|
| CALibration[:ALL].....                           | 891 |
| CALibration:RESult?.....                         | 892 |
| DIAGnostic:SERvice:INPut:MC:CFRequency.....      | 892 |
| DIAGnostic:SERvice:INPut:MC[:DISTance].....      | 892 |
| DIAGnostic:SERvice:INPut:PULSed:CFRequency.....  | 892 |
| DIAGnostic:SERvice:INPut:PULSed:MCFRequency..... | 893 |
| DIAGnostic:SERvice:INPut:PULSed:WBFRequency..... | 893 |
| DIAGnostic:SERvice:INPut:RF[:SPECtrum].....      | 893 |
| DIAGnostic:SERvice:INPut[:SElect].....           | 894 |
| DIAGnostic:SERvice:STESt:RESult?.....            | 894 |
| SOURce<si>:TEMPerature:FRONtend.....             | 894 |

**CALibration[:ALL] <UseData>**

This command initiates a calibration (self-alignment) routine and queries if calibration was successful.

During the acquisition of correction data the instrument does not accept any remote control commands.

In order to recognize when the acquisition of correction data is completed, the MAV bit in the status byte can be used. If the associated bit is set in the Service Request Enable (SRE) register, the instrument generates a service request after the acquisition of correction data has been completed.

**Return values:**

<CalState>           ON | OFF | 0 | 1

**OFF | 0**  
Calibration was successful.

**ON | 1**  
Calibration was not successful.

**Example:**           \*CLS  
Resets the status management.

                  \*SRE 16  
Enables MAV bit in the Service Request Enable register.

                  \*CAL?  
Starts the correction data recording, and then a service request is generated.

**Manual operation:** See " [Start Self Alignment](#) " on page 165

---

**CALibration:RESult?**

This command returns the results collected during calibration.

**Return values:**

<CalibrationData> String containing the calibration data.

**Example:**

```
CAL:RES?
would return, e.g.
Total Calibration Status:
PASSED, Date (dd/mm/yyyy): 12/07/2004,
Time: 16:24:54, Runtime: 00.06
```

**Usage:** Query only

**Manual operation:** See " [Alignment Results:](#) " on page 165

---

**DIAGnostic:SERVice:INPut:MC:CFrequency <Frequency>**

This command defines the frequency of the calibration signal for R&S FPL1000 models 43 MHz and higher.

This command only takes effect if a microwave calibration signal is selected for input ([DIAGnostic:SERVice:INPut\[:SElect\]](#) on page 894)

**Parameters:**

<Frequency> \*RST: 8.004 GHz  
Default unit: Hz

---

**DIAGnostic:SERVice:INPut:MC[:DISTance] <Bandwidth>**

This command selects the distance of the peaks of the microwave calibration signal for calibration of the YIG filter.

**Parameters:**

<Bandwidth> WIDE | SMALI  
**SMALI**  
Small offset of combine frequencies.  
**WIDE**  
Wide offset of combine frequencies.

---

**DIAGnostic:SERVice:INPut:PULSed:CFrequency <Frequency>**

This command defines the frequency of the calibration signal.

Before you can use the command, you have to feed in a calibration signal with [DIAGnostic:SERVice:INPut\[:SElect\]](#) on page 894.

**Parameters:**

&lt;Frequency&gt;

Possible frequencies of the calibration signal are fix.

If you define a frequency that is not available, the R&S FPL1000 uses the next available frequency. Example: a frequency of 20 MHz is rounded up to the next available frequency (25 MHz).

\*RST: 50 MHz

Default unit: Hz

**Manual operation:** See "[Calibration Frequency RF](#)" on page 150**DIAGnostic:SERVice:INPut:PULSed:MCFRequency** <Frequency>

This command sets the calibration frequency for frequencies greater than 7 GHz. This command only takes effect if a microwave calibration signal is selected for input ([DIAGnostic:SERVice:INPut\[:SElect\]](#) on page 894).

**Parameters:**

&lt;Frequency&gt;

\*RST: 7 GHz

Default unit: Hz

**Example:**

DIAG:SERV:INP:PULS:MCFR 7,1 GHz

**DIAGnostic:SERVice:INPut:PULSed:WBFRequency** <Frequency>

Defines the frequency of the internal broadband calibration signal to be used for IF filter calibration.

This command is only available if the bandwidth extension option R&S FPL1-B160 is installed.

Before you can use the command, you have to feed in a calibration signal with [DIAGnostic:SERVice:INPut\[:SElect\]](#) on page 894.

**Parameters:**

&lt;Frequency&gt;

2 MHz | 4 MHz | 8 MHz | 16 MHz

If you define a frequency that is not available, the R&S FPL1000 uses the next available frequency.

\*RST: 16 MHz

Default unit: Hz

**Example:**

DIAG:SERV:INP:PULS:WBFR 8 MHz

Defines a calibration signal frequency of 8 MHz.

**Example:**

DIAG:SERV:INP:SEL WBC

DIAG:SERV:INP:PULS:WBFR 4MHz

**DIAGnostic:SERVice:INPut:RF[:SPEctrum]** <Bandwidth>

This command selects the bandwidth of the calibration signal.

**Parameters:**

&lt;Bandwidth&gt;

NARRowband | BROAdband

**NARRowband**

Narrowband signal for power calibration of the frontend.

**BROadband**

Broadband signal for calibration of the IF filter.

---

**DIAGnostic:SERvice:INPut[:SElect] <Signal>**

This command activates or deactivates the use of an internal calibration signal as input for the R&S FPL1000.

**Parameters:**

<Signal>

**CALibration**

Uses the calibration signal as RF input.

**RF**

Uses the signal from the RF input.

\*RST: RF

**Example:**

DIAG:SERV:INP CAL

Uses the calibration signal as RF input.

**Manual operation:**

See " [NONE](#) " on page 150

See " [Calibration Frequency RF](#) " on page 150

---

**DIAGnostic:SERvice:STESt:RESult?**

This command queries the self-test results.

**Return values:**

<Results>

String of data containing the results.

The rows of the self-test result table are separated by commas.

**Example:**

DIAG:SERV:STES:RES?

would return, e.g.

"Total Selftest Status:

PASSED", "Date (dd/mm/yyyy): 09/07/2004 TIME:

16:24:54", "Runtime: 00:06", "...

**Usage:**

Query only

---

**SOURce<si>:TEMPerature:FRONTend**

This command queries the current frontend temperature of the R&S FPL1000.

During self-alignment, the instrument's (frontend) temperature is also measured (as soon as the instrument has warmed up completely). This temperature is used as a reference for a continuous temperature check during operation. If the current temperature deviates from the stored self-alignment temperature by a certain degree, a warning is displayed in the status bar indicating the resulting deviation in the measured power levels. A status bit in the `STATUS:QUESTIONABLE:TEMPerature` register indicates a possible deviation.

**Suffix:**

<si>

irrelevant

**Return values:**

<Temperature>      Temperature in degrees Celsius.

**Example:**

SOUR:TEMP:FRON?

Queries the temperature of the frontend sensor.

### 9.10.3 Working with Transducers

The following commands configure and control transducer factors.

#### Useful commands for transducer management described elsewhere

- `MMEMoRY:SELEct[:ITEM]:TRANsdUcer:ALL` on page 871

#### Remote commands exclusive to transducer management

|                                                                        |     |
|------------------------------------------------------------------------|-----|
| <code>[SENSe:]CORRection:TRANsdUcer:ADJust:RLEVel[:STATe]</code> ..... | 895 |
| <code>[SENSe:]CORRection:TRANsdUcer:CATalog?</code> .....              | 895 |
| <code>[SENSe:]CORRection:TRANsdUcer:COMMeNt</code> .....               | 896 |
| <code>[SENSe:]CORRection:TRANsdUcer:DATA</code> .....                  | 896 |
| <code>[SENSe:]CORRection:TRANsdUcer:DELeTe</code> .....                | 897 |
| <code>[SENSe:]CORRection:TRANsdUcer:SCALing</code> .....               | 897 |
| <code>[SENSe:]CORRection:TRANsdUcer:SELEct</code> .....                | 897 |
| <code>[SENSe:]CORRection:TRANsdUcer[:STATe]</code> .....               | 897 |
| <code>[SENSe:]CORRection:TRANsdUcer:UNIT</code> .....                  | 898 |
| <code>MMEMoRY:LOAD&lt;n&gt;:TFACtor</code> .....                       | 898 |
| <code>MMEMoRY:STORe&lt;n&gt;:TFACtor</code> .....                      | 898 |

---

#### `[SENSe:]CORRection:TRANsdUcer:ADJust:RLEVel[:STATe]` <State>

This command turns an automatic adjustment of the reference level to the transducer on and off.

Before you can use the command, you have to select and turn on a transducer.

**Parameters:**

<State>      ON | OFF | 1 | 0

\*RST:      0

**Manual operation:** See " [Adjust Ref Level](#) " on page 156

---

#### `[SENSe:]CORRection:TRANsdUcer:CATalog?`

This command queries all transducer factors stored on the R&S FPL1000.

After general data for the transducer storage directory, data for the individual files is listed.

The result is a comma-separated list of values with the following syntax:

<UsedMem>,<FreeMem>,<FileSize>,<FileName>[,<FileSize>,<FileName>]

**Return values:**

|                 |                                                                                                                                                                                          |
|-----------------|------------------------------------------------------------------------------------------------------------------------------------------------------------------------------------------|
| <UsedDiskSpace> | numeric value in bytes<br>Amount of storage space required by all transducer files in the C:\ProgramData\Rohde-Schwarz\ZNL-FPL\trd directory (= sum of all individual <FileSize> values) |
| <FreeDiskSpace> | numeric value in bytes<br>Amount of free storage space on the R&S FPL1000                                                                                                                |
| <FileSize>      | numeric value in bytes<br>Size of a single transducer file                                                                                                                               |
| <FileName>      | string<br>Name of a single transducer file                                                                                                                                               |

**Example:**

```
SENSE:CORR:TRAN:CAT?
//Result: 2743,2312620544,720,'FactorGSM.TDF',2023,'FactorBTS.TDF'
```

**Usage:**

Query only

**[SENSe:]CORRection:TRANsducer:COMMENT <Comment>**

This command defines the comment for the selected transducer factor.

Before you can use the command, you have to select and turn on a transducer.

**Parameters:**

<Comment> \*RST: (empty comment)

**Manual operation:** See "[Comment](#)" on page 157

**[SENSe:]CORRection:TRANsducer:DATA {<Frequency>, <Level>}...**

This command configures transducer factors for specific trace points. A set of transducer factors defines an interpolated transducer line and can be stored on the instrument.

**Parameters:**

<Frequency> The unit for <Frequency> is Hz, which may or may not be omitted. Frequencies have to be sorted in ascending order.  
Default unit: Hz

<Level> The unit for <Level> depends on [\[SENSe:\]CORRection:TRANsducer:UNIT](#).

**Example:**

```
SENSe1:CORRection:TRANsducer:UNIT 'DB'
// Frequency Span 0 Hz to 4 Ghz
SENSe1:CORRection:TRANsducer:DATA 0,8,2GHz,5,4GHz,3
```

Creates the transducer points:

**Manual operation:** See "[Data Points](#)" on page 158



| Frequency | Level |
|-----------|-------|
| 0 Hz      | 8 dB  |
| 2 GHz     | 5 dB  |
| 4 GHz     | 3 dB  |

---

**[SENSe:]CORRection:TRANsducer:DELeTe**

This command deletes the currently selected transducer factor.

Before you can use the command, you have to select a transducer.

**Example:** `CORR:TRAN:DEL`

**Manual operation:** See "[Delete Line](#)" on page 156

---

**[SENSe:]CORRection:TRANsducer:SCALing <ScalingType>**

This command selects the frequency scaling of the transducer factor.

**Parameters:**

<ScalingType> LINear | LOGarithmic  
 \*RST: LINear

**Manual operation:** See "[X-Axis Scaling](#)" on page 158

---

**[SENSe:]CORRection:TRANsducer:SELeCt <Name>**

This command selects a transducer factor.

**Parameters:**

<Name> String containing the name of the transducer factor.  
 If the name does not exist yet, the R&S FPL1000 creates a transducer factor by that name.

**Example:** `CORR:TRAN:SEL 'FACTOR1'`

**Manual operation:** See "[Activating / Deactivating](#)" on page 155  
 See "[Create New Line](#)" on page 156  
 See "[Name](#)" on page 157

---

**[SENSe:]CORRection:TRANsducer[:STATe] <State>**

This command turns the selected transducer factor on or off.

Before you can use the command, you have to select a transducer.

**Parameters:**

<State> ON | OFF | 1 | 0  
 \*RST: 0

**Manual operation:** See "[Activating / Deactivating](#)" on page 155

**[SENSe:]CORRection:TRANsducer:UNIT <Unit>**

This command selects the unit of the transducer factor.

Before you can use the command, you have to select and turn on a transducer.

**Parameters:**

<Unit> string as defined in table below  
\*RST: DB

**Example:** CORR:TRAN:UNIT 'DBUV'

**Manual operation:** See " [Unit](#) " on page 157

| String   | Unit                                                               |
|----------|--------------------------------------------------------------------|
| 'DB'     | dB                                                                 |
| 'DBM'    | dBm                                                                |
| 'DBMV'   | dBmV                                                               |
| 'DBUV'   | dB $\mu$ V                                                         |
| 'DBUV/M' | dB $\mu$ V/m<br>(Requires R&S FPL1-K54 (EMI measurements) option.) |
| 'DBUA'   | dB $\mu$ A                                                         |
| 'DBUA/M' | dB $\mu$ A/m<br>(Requires R&S FPL1-K54 (EMI measurements) option.) |
| 'DBPW'   | dBpW                                                               |
| 'DBPT'   | dBpT                                                               |

**MMEMory:LOAD<n>:TFACtor <FileName>**

Loads the transducer factor from the selected file in .CSV format.

**Suffix:**

<n> irrelevant

**Parameters:**

<FileName> String containing the path and name of the CSV import file.

**Example:** MMEM:LOAD:TFAC 'C:\TEST.CSV'

**Manual operation:** See " [Import](#) " on page 159

**MMEMory:STORe<n>:TFACtor <FileName>, <TransdName>**

This command exports transducer factor data to an ASCII (CSV) file.

For details on the file format see [Chapter 7.3.6.3, "Reference: Transducer Factor File Format"](#), on page 159.

**Suffix:**

<n> irrelevant

**Parameters:**

<FileName> Name of the transducer factor to be exported.

<TransdName> Name of the transducer factor to be exported.

**Example:**

```
MMEM:STOR:TFAC 'C:\TEST', 'Transducer1'
Stores the transducer factor named "Transducer1" in the file
TEST.CSV.
```

**Manual operation:** See " [Export](#) " on page 159

## 9.10.4 Customizing the Screen Layout

The remote commands required to set up the display of the R&S FPL1000 are described here.

- [General Display Settings and Items](#).....899
- [Colors and Themes](#).....902

### 9.10.4.1 General Display Settings and Items

The following commands add, remove or customize general display and screen elements.

**Useful commands for general display settings described elsewhere**

- [DISPlay\[:WINDow<n>\]:MTABle](#) on page 790

**Remote commands exclusive to general display settings**

|                                                             |     |
|-------------------------------------------------------------|-----|
| <a href="#">DISPlay:ANNotation:CBAR</a> .....               | 899 |
| <a href="#">DISPlay:BLIGHting</a> .....                     | 900 |
| <a href="#">DISPlay:ANNotation:FREQuency</a> .....          | 900 |
| <a href="#">DISPlay:SBAR[:STATe]</a> .....                  | 900 |
| <a href="#">DISPlay:SKEYs[:STATe]</a> .....                 | 900 |
| <a href="#">DISPlay:TBAR[:STATe]</a> .....                  | 900 |
| <a href="#">DISPlay:TOUChscreen[:STATe]</a> .....           | 901 |
| <a href="#">DISPlay[:WINDow&lt;n&gt;]:TIME</a> .....        | 901 |
| <a href="#">DISPlay[:WINDow&lt;n&gt;]:TIME:FORMat</a> ..... | 901 |
| <a href="#">SYSTem:DISPlay:FPANel[:STATe]</a> .....         | 902 |

---

**DISPlay:ANNotation:CBAR <State>**

This command hides or displays the channel bar information.

**Parameters:**

<State> ON | OFF | 0 | 1

\*RST: 1

**Example:**

```
DISP:ANN:CBAR OFF
```

**Manual operation:** See " [Channel Bar](#) " on page 134

---

**DISPlay:BLIGHting** <Brightness>

Changes the brightness of the display in eight steps.

**Parameters:**

<Brightness>            integer  
Range:            0 to 7  
\*RST:            3

**Example:**

DISP:BLIG 3  
Reduces the brightness of the display.

**Manual operation:** See "[Background Lighting](#)" on page 132

---

**DISPlay:ANNOtation:FREQuency** <State>

This command turns the label of the x-axis on and off.

**Parameters:**

<State>            ON | OFF | 0 | 1  
\*RST:            1

**Example:**

DISP:ANN:FREQ OFF

**Manual operation:** See "[Diagram Footer \(Annotation\)](#)" on page 134

---

**DISPlay:SBAR[:STATe]** <State>

This command turns the status bar on and off.

**Parameters:**

<State>            ON | OFF | 0 | 1  
\*RST:            1

**Example:**

DISP:SBAR:OFF

**Manual operation:** See "[Status Bar](#)" on page 134

---

**DISPlay:SKEYs[:STATe]** <State>

This command turns the softkey bar on and off.

**Parameters:**

<State>            ON | OFF | 0 | 1  
\*RST:            1

**Example:**

DISP:SKEY:OFF

**Manual operation:** See "[Softkey Bar](#)" on page 134

---

**DISPlay:TBAR[:STATe]** <State>

This command turns the toolbar on or off.

**Parameters:**

<State> ON | OFF | 1 | 0  
 \*RST: 0

**Example:** DISP:TBAR ON

**Manual operation:** See "[Toolbar](#)" on page 133

**DISPlay:TOUCHscreen[:STATe] <State>**

This command controls the touch screen functionality.

**Parameters:**

<State> ON | FRAMe | OFF  
**ON | 1**  
 Touch screen is active for entire screen  
**OFF | 0**  
 Touch screen is inactivate for entire screen  
**FRAMe**  
 Touch screen is inactivate for the diagram area of the screen,  
 but active for softkeys, toolbars and menus.  
 \*RST: 1

**Example:** DISP:TOUC:STAT ON

**Manual operation:** See "[Deactivating and Activating the Touchscreen](#)" on page 132

**DISPlay[:WINDow<n>]:TIME <State>**

This command adds or removes the date and time from the display.

**Suffix:**

<n> irrelevant

**Parameters:**

<State> ON | OFF | 1 | 0  
 \*RST: 0

**Example:** DISP:TIME ON

**Manual operation:** See "[Date and Time](#)" on page 134

**DISPlay[:WINDow<n>]:TIME:FORMat <Format>**

This command selects the time and date format.

**Suffix:**

<n> irrelevant

**Parameters:**

<Format> US | DE

**DE**  
dd.mm.yyyy hh:mm:ss  
24 hour format.

**US**  
mm/dd/yyyy hh:mm:ss  
12 hour format.

\*RST: DE

**Example:** DISP:TIME ON  
Switches the screen display of date and time on.  
DISP:TIME:FORM US  
Switches the date and time format to US.

**Manual operation:** See " [Date and Time Format](#) " on page 132

#### **SYSTem:DISPlay:FPANel[:STATe] <State>**

This command includes or excludes the front panel keys when working with the remote desktop.

##### **Parameters:**

<State> ON | OFF | 0 | 1  
\*RST: 1

**Manual operation:** See " [Front Panel](#) " on page 135  
See " [Mini Front Panel](#) " on page 135

### 9.10.4.2 Colors and Themes

#### **Useful commands to customize display colors described elsewhere**

The HCOpy commands define the print colors and thus only take effect on the display colors, if the display shows the printing colors.

- [HCOpy:CMAP<it>:DEFault<ci>](#) on page 878

#### **Remote commands exclusive to customize the display colors and themes**

|                                                                |     |
|----------------------------------------------------------------|-----|
| <a href="#">DISPlay:CMAP&lt;it&gt;:DEFault&lt;ci&gt;</a> ..... | 902 |
| <a href="#">DISPlay:THEMe:CATalog?</a> .....                   | 903 |
| <a href="#">DISPlay:THEMe:SElect</a> .....                     | 903 |

#### **DISPlay:CMAP<it>:DEFault<ci>**

This command resets the color scheme for the display. The query returns the default color scheme.

##### **Suffix:**

<it> Irrelevant.

<ci> 1  
Current colors with a white background and a black grid.  
2  
Optimized colors.  
4  
Current screen colors (setting for hardcopies).  
Suffix irrelevant for query

**Return values:**

<DefScheme> 1 | 2 | 3 | 4  
The default color scheme for the selected item, as specified by the <ci> suffix.

**Example:**

```
DISP:CMAP:DEF2
Selects default setting 2 for setting the colors.
DISP:CMAP:DEF?
//Result: 2
```

---

**DISPlay:THEMe:CATalog?**

This command queries all available display themes.

**Return values:**

<Themes> String containing all available display themes.

**Example:**

```
DISP:THEMe:CAT?
```

**Usage:**

Query only

---

**DISPlay:THEMe:SElect <Theme>**

This command selects the display theme.

**Parameters:**

<Theme> String containing the name of the theme.  
\*RST: SPL

**Example:**

```
DISP:THEM:SEL "OceanBlue"
```

**Manual operation:** See "Theme" on page 137

## 9.10.5 Remote Commands for Language Settings

[SYSTem:DISPlay:LANGuage](#)..... 903

---

**SYSTem:DISPlay:LANGuage <Language>**

Defines the language of the software-defined interface elements (such as softkeys, dialog boxes, diagram texts etc.).

**Parameters:**

<Language> 'EN' | 'ZH\_CH' | 'ZH\_TW' | 'JA' | 'KO' | 'RU'

'ZH\_CH'  
Simplified Chinese

'ZH\_TW'  
Traditional Chinese

\*RST: 'EN'

**Example:**

SYST:DISP:LANG 'JA'

Switches the language of the instrument to Japanese.

## 9.10.6 Configuring the Network and Remote Control

The following commands are required to configure a network or remote control for the R&S FPL1000.

Useful commands for configuring remote control described elsewhere:

- [SYSTem:LANGuage](#) on page 915

### Remote commands exclusive to configuring a network and remote control

|                                                                  |     |
|------------------------------------------------------------------|-----|
| <a href="#">SYSTem:COMMunicate:GPIB[:SELF]:ADDRess</a> .....     | 904 |
| <a href="#">SYSTem:COMMunicate:GPIB[:SELF]:RTERminator</a> ..... | 904 |
| <a href="#">SYSTem:DISPlay:LOCK</a> .....                        | 905 |
| <a href="#">SYSTem:DISPlay:UPDate</a> .....                      | 905 |
| <a href="#">SYSTem:ERRor:DISPlay</a> .....                       | 906 |
| <a href="#">SYSTem:IDENtify:FACTory</a> .....                    | 906 |
| <a href="#">SYSTem:IDENtify[:STRing]</a> .....                   | 906 |
| <a href="#">SYSTem:KLOCK</a> .....                               | 906 |
| <a href="#">SYSTem:LANGuage</a> .....                            | 906 |
| <a href="#">SYSTem:LXI:INFO?</a> .....                           | 907 |
| <a href="#">SYSTem:LXI:LANReset</a> .....                        | 907 |
| <a href="#">SYSTem:LXI:MDEscription</a> .....                    | 907 |
| <a href="#">SYSTem:LXI:PASSword</a> .....                        | 907 |
| <a href="#">SYSTem:REVision:FACTory</a> .....                    | 908 |

---

### **SYSTem:COMMunicate:GPIB[:SELF]:ADDRess** <Address>

This command sets the GPIB address of the R&S FPL1000.

**Parameters:**

<Address>                    Range:        0 to 30  
\*RST:                        (no influence on this parameter, factory default 20)

**Example:**                    SYST:COMM:GPIB:ADDR 18

**Manual operation:**        See "[GPIB Address](#)" on page 209

---

### **SYSTem:COMMunicate:GPIB[:SELF]:RTERminator** <Terminator>

This command selects the GPIB receive terminator.



Output of binary data from the instrument to the control computer does not require such a terminator change.

**Parameters:**

<Terminator> LFEOI | EOI

**LFEOI**

According to the standard, the terminator in ASCII is <LF> and/or <EOI>.

**EOI**

For binary data transfers (e.g. trace data) from the control computer to the instrument, the binary code used for <LF> might be included in the binary data block, and therefore should not be interpreted as a terminator in this particular case. This can be avoided by using only the receive terminator EOI.

\*RST: LFEOI

**Example:**

SYST:COMM:GPIB:RTER EOI

**Manual operation:** See "[GPIB Terminator](#)" on page 210

**SYSTem:DISPlay:LOCK <State>**

Defines whether the "Display Update" function remains available in remote operation or not.

**Parameters:**

<State> ON | OFF | 0 | 1

**OFF | 0**

The function remains available.

**ON | 1**

The function is not available and the display is not updated during remote operation.

\*RST: 0

**SYSTem:DISPlay:UPDate <State>**

This command turns the display during remote operation on and off.

If on, the R&S FPL1000 updates the diagrams, traces and display fields only.

The best performance is obtained if the display is off during remote control operation.

**Parameters:**

<State> ON | OFF | 1 | 0

\*RST: 0

**Example:**

SYST:DISP:UPD ON

**Manual operation:** See "[Remote Display Update](#)" on page 210

---

**SYSTem:ERRor:DISPlay** <State>

This command the error display during remote operation on and off.

If activated, the R&S FPL1000 displays a message box at the bottom of the screen that contains the most recent type of error and the command that caused the error.

**Parameters:**

<State>                    ON | OFF | 1 | 0  
                              \*RST:        0

**Example:**                SYST:ERR:DISP ON

**Manual operation:**    See "[Display Remote Errors](#)" on page 210

---

**SYSTem:IDENtify:FACTory**

This command resets the query to \*IDN? to its default value.

**Manual operation:**    See "[Reset to Factory String](#)" on page 209

---

**SYSTem:IDENtify[:STRing]** <String>

This command defines the response to \*IDN?.

**Parameters:**

<String>                    String containing the description of the instrument.

**Manual operation:**    See "[Identification String](#)" on page 209

---

**SYSTem:KLOCK** <State>

This command activates the local lockout (remote control) or returns to the local mode.

**Parameters:**

<State>                    **ON**  
                              LLO (local lockout)  
                              **OFF**  
                              GTL (go to local)  
                              \*RST:        OFF

**Example:**                SYST:KLOK ON  
                              Activates LLO (remote control)

**Manual operation:**    See "[Local](#)" on page 217

---

**SYSTem:LANGUage** <Language>

This function is used to emulate previous R&S signal and spectrum analyzers.

**Parameters:**

<Language>                "FSV" | "SCPI"  
                              \*RST:        SCPI

**Example:**                    `SYST:LANG FSV`  
 The commands and settings for the R&S FSV instrument are used.

---

### **SYSTem:LXI:INFO?**

This command queries the LXI settings.

**Return values:**

<LXIInfo>                    <current version> | <LXI class> | <Computername> |  
 <MAC address> | <IP adress> | <Auto MDIX>  
 String containing the current LXI parameters.

- <version>
- <LXIclass>
- <ComputerName>
- <MACAddress>
- <IPAddress>
- <AutoMDIX>

**Usage:**                    Query only

**Manual operation:**    See "[Current LXI Configuration](#)" on page 214

---

### **SYSTem:LXI:LANReset**

This command resets the LAN configuration as required by the LXI standard. The command also resets the LXI password and instrument description.

**Manual operation:**    See "[LAN Reset](#)" on page 215

---

### **SYSTem:LXI:MDEscription <Description>**

This command defines the LXI instrument description.

**Parameters:**

<Description>                String containing the instrument description.

**Manual operation:**    See "[LXI Manufacturer Description](#)" on page 215

---

### **SYSTem:LXI:PASSword <Password>**

This command defines the LXI password.

**Parameters:**

<Password>                    String containing the password.

**Return values:**

<Password>                    The query returns the current password.

**Manual operation:**    See "[LXI Password](#)" on page 214

---

**SYSTem:REVision:FACTory**

Resets the response to the `REV?` query to the factory default value.

**Usage:** Event

**Manual operation:** See "[Resetting the Factory Revision](#)" on page 213

## 9.10.7 Checking the System Configuration

The following commands are required to check the system configuration on the R&S FPL1000.

Useful commands for obtaining system information described elsewhere:

- [DIAGnostic:SERVice:SINFo?](#) on page 913

**Remote commands exclusive to obtaining system information:**

|                                                         |     |
|---------------------------------------------------------|-----|
| <a href="#">DIAGnostic:SERVice:BATTery:LEVel?</a> ..... | 908 |
| <a href="#">DIAGnostic:SERVice:BIOSinfo?</a> .....      | 908 |
| <a href="#">DIAGnostic:SERVice:HWINfo?</a> .....        | 909 |
| <a href="#">DIAGnostic:SERVice:VERSinfo?</a> .....      | 909 |
| <a href="#">SYSTem:ERRor:CLEar:ALL</a> .....            | 909 |
| <a href="#">SYSTem:ERRor:CLEar:REMote</a> .....         | 909 |
| <a href="#">SYSTem:ERRor:EXTended?</a> .....            | 910 |
| <a href="#">SYSTem:ERRor:LIST?</a> .....                | 910 |
| <a href="#">SYSTem:ERRor[:NEXT]?</a> .....              | 911 |
| <a href="#">SYSTem:FIRMware:UPDate</a> .....            | 911 |
| <a href="#">SYSTem:FORMat:IDENT</a> .....               | 911 |
| <a href="#">SYSTem:PRESet:COMPAtible</a> .....          | 912 |

---

**DIAGnostic:SERVice:BATTery:LEVel?**

Queries the current charge state of the optional battery packs.

**Return values:**

<ChargeState>      numeric value  
                          Charge state in percent  
                          Range:      0 to 100

**Example:**            `DIAG:SERV:BATT:LEV?`

**Usage:**              Query only

---

**DIAGnostic:SERVice:BIOSinfo?**

This command queries the BIOS version of the CPU board.

**Return values:**

<BiosInformation>    String containing the BIOS version.

**Example:**            `DIAG:SERV:BIOS?`  
Returns the BIOS version.

**Usage:** Query only

---

#### **DIAGnostic:SERvice:HWInfo?**

This command queries hardware information.

**Return values:**

<Hardware> String containing the following information for every hardware component.  
 <component>: name of the hardware component  
 <serial#>: serial number of the component  
 <order#>: order number of the component  
 <model>: model of the component  
 <code>: code of the component  
 <revision>: revision of the component  
 <subrevision>: subrevision of the component

**Example:**

```
DIAG:SERV:HWIN?
Queries the hardware information.
"FRONTEND|100001/003|1300.3009|03|01|00|00",
"MOTHERBOARD|123456/002|1300.3080|02|00|00|00",
...
```

**Usage:** Query only

---

#### **DIAGnostic:SERvice:VERSInfo?**

This command queries information about the hardware and software components.

**Return values:**

<Information> String containing the version of hardware and software components including the types of licenses for installed options.

**Example:**

```
DIAG:SERV:VERS?
Queries the version information.
Response:
```

**Usage:** Query only

---

#### **SYSTem:ERRor:CLEar:ALL**

This command deletes all contents of the "System Messages" table.

**Example:** SYST:ERR:CLE:ALL

---

#### **SYSTem:ERRor:CLEar:REMOte**

This command deletes all contents of the "Remote Errors" table.

Note: The remote error list is automatically cleared when the R&S FPL1000 is shut down.

**Example:** SYST:ERR:CLE:REM

**Manual operation:** See ["Display Remote Errors"](#) on page 210  
See ["Clear Error List"](#) on page 216

---

### **SYSTem:ERRor:EXTended?** <MessageType>[, <ChannelName>]

This command queries all system messages, or all messages of a defined type, displayed in the status bar for a specific channel setup (application).

**Note:** This command queries the strings displayed for manual operation. For remote programs, do not define processing steps depending on these results. Instead, query the results of the `STATus:QUESTionable:EXTended:INFO` status register, which indicates whether messages of a certain type have occurred (see ["STATus:QUESTionable:EXTended:INFO Register"](#) on page 196).

#### **Parameters:**

<MessageType> ALL | INFO | WARNIng | FATal | ERRor | MESSAge  
<ChannelName> String containing the name of the channel setup.  
The parameter is optional. If you omit it, the command works for the currently active channel setup.

#### **Return values:**

<Messages> String containing all messages of the selected type for the specified channel setup. Each message is separated by a comma and inserted in parentheses. If no messages are available, empty parentheses are returned.

#### **Example:**

```
SYST:ERR:EXT? ALL
```

Returns all messages for the currently active application, e.g. *"Message 1", "Message 2"*.

#### **Example:**

```
SYST:ERR:EXT? FAT, 'Spectrum2'
```

Queries fatal errors in the 'Spectrum2' application. If none have occurred, the result is: " "

#### **Usage:**

Query only

---

### **SYSTem:ERRor:LIST?** [<MessType>]

This command queries the error messages that occur during R&S FPL1000 operation.

#### **Query parameters:**

<MessType> SMSG | REMote

#### **SMSG**

(default) Queries the system messages which occurred during manual operation.

#### **REMote**

Queries the error messages that occurred during remote operation.

Note: The remote error list is automatically cleared when the R&S FPL1000 is shut down.

**Return values:**

<SystemMessages> String containing all messages in the "System Messages" table.

<RemoteErrors> <Error\_no> | <Description> | <Command> | <Date> | <Time>  
 Comma-separated list of errors from the "Remote Errors" table, where:  
 <Error\_no>: device-specific error code  
 <Description>: brief description of the error  
 <Command>: remote command causing the error  
 <Date>|<Time>: date and time the error occurred

**Usage:** Query only

---

**SYSTem:ERRor[:NEXT]?**

This command queries the most recent error queue entry and deletes it.

Positive error numbers indicate device-specific errors, negative error numbers are error messages defined by SCPI. If the error queue is empty, the error number 0, "No error", is returned.

For details on error queues see [Chapter 7.4.1.7, "Status Reporting System"](#), on page 187.

**Usage:** Query only

---

**SYSTem:FIRMware:UPDate <Directory>**

This command starts a firmware update using the \*.msi files in the selected directory. The default path is D:\FW\_UPDATE. The path is changed via the [MMEMory:COMMeNt](#) command. To store the update files the [MMEMory:DATA](#) command is used.

Only user accounts with administrator rights can perform a firmware update.

**Setting parameters:**

<Directory>

**Example:** `SYST:FIRM:UPD 'D:\FW_UPDATE'`  
 Starts the firmware update from directory "D:\FW\_UPDATE".

---

**SYSTem:FORMat:IDENt <IDNFormat>**

This command selects the response format to the [\\*IDN?](#) query.

**Parameters:**

<IDNFormat> **NEW | FSL**  
 R&S FPL1000 format  
 Format is also compatible to the R&S FSL and R&S FSV family  
 \*RST: not reset!

**SYSTem:PRESet:COMPAtible** <OpMode>

This command defines the operating mode that is activated when you switch on the R&S FPL1000 or press the [PRESET] key.

**Parameters:**

<OpMode>                    **SANalyzer**  
(Default:)  
Defines Signal and Spectrum Analyzer operating mode as the presetting.

**9.10.8 Using Service Functions**

|                                                  |     |
|--------------------------------------------------|-----|
| DIAGnostic:SERVice:SFUNction.....                | 912 |
| DIAGnostic:SERVice:SFUNction:LASTresult?.....    | 912 |
| DIAGnostic:SERVice:SFUNction:RESults:DELeTe..... | 913 |
| DIAGnostic:SERVice:SFUNction:RESults:SAVE.....   | 913 |
| DIAGnostic:SERVice:SINFo?.....                   | 913 |
| SYSTem:PASSword[:CENable].....                   | 913 |
| SYSTem:PASSword:RESet.....                       | 914 |

**DIAGnostic:SERVice:SFUNction** <ServiceFunction>

This command starts a service function.

The service functions are available after you have entered the level 1 or level 2 system password.

**Parameters:**

<ServiceFunction>    String containing the ID of the service function.  
The ID of the service function is made up out of five numbers, separated by a point.

- function group number
- board number
- function number
- parameter 1 (see the Service Manual)
- parameter 2 (see the Service Manual)

**Manual operation:**    See " [Service Function](#) " on page 151  
See " [Send](#) " on page 151

**DIAGnostic:SERVice:SFUNction:LASTresult?**

This command queries the results of the most recent service function you have used.

**Return values:**

<Result>

**Usage:**                    Query only



---

**DIAGnostic:SERVice:SFUNction:RESults:DELeTe**

This command deletes the results of the most recent service function you have used.

**Manual operation:** See " [Clear Results](#) " on page 152

---

**DIAGnostic:SERVice:SFUNction:RESults:SAVE [<FileName>]**

This command saves the results of the most recent service function you have used.

**Parameters:**

<FileName> String containing the file name.

**Manual operation:** See " [Save Results](#) " on page 152

---

**DIAGnostic:SERVice:SI NFo?**

This command creates a \*.zip file with important support information. The \*.zip file contains the system configuration information ("device footprint"), the current eeprom data and a screenshot of the screen display (if available).

As a result of this command, the created file name (including the drive and path) is returned.

If you contact the Rohde&Schwarz support to get help for a certain problem, send this file to the support in order to identify and solve the problem faster.

**Return values:**

<FileName> String containing the drive, path and file name of the created support file, where the file name consists of the following elements:

- <R&S Device ID>**: The unique R&S device ID indicated in the "Versions + Options" information
- <CurrentDate>**: The date on which the file is created (<YYYYMMDD>)
- <CurrentTime>**: The time at which the file is created (<HHMMSS>)

**Example:** DIAG:SERV:SI NF?  
Result:

**Usage:** Query only

**Manual operation:** See " [Create R&S Support Information](#) " on page 148

---

**SYSTem:PASSword[:CENable] <arg0>**

Provides a password for subsequent service functions.

**Parameters:**

<arg0> string

**Example:** SYST:PASS:CEN '894129'

**Manual operation:** See " [Password](#) " on page 152

**SYSTem:PASSword:RESet**

Clears any previously provided password and returns to the most restrictive service level.

**Manual operation:** See " [Password](#) " on page 152

## 9.11 Emulating Other Instruments' Commands

The R&S FPL1000 analyzer family supports a subset of the GPIB commands of several HP and PSA instruments.

For details see [Chapter 7.4.2, "GPIB Languages"](#), on page 204.

- [Setting up Instrument Emulation](#)..... 914
- [Reference: GPIB Commands of Emulated HP Models](#)..... 916
- [Reference: Command Set of Emulated CXA/EXA Models](#)..... 944

### 9.11.1 Setting up Instrument Emulation

The following commands are required to set up the use of commands to emulate other instruments.

Useful commands for emulating other instruments described elsewhere:

- [SYSTem:REVision:FACTory](#) on page 908

**Remote commands exclusive to emulating other instruments:**

|                                                |     |
|------------------------------------------------|-----|
| <a href="#">SYSTem:HPCoupling</a> .....        | 914 |
| <a href="#">SYSTem:IFGain:MODE</a> .....       | 915 |
| <a href="#">SYSTem:LANGuage</a> .....          | 915 |
| <a href="#">SYSTem:PSA:WIDeband</a> .....      | 915 |
| <a href="#">SYSTem:REVision[:STRing]</a> ..... | 916 |
| <a href="#">SYSTem:RSWeep</a> .....            | 916 |

---

**SYSTem:HPCoupling <CouplingType>**

Controls the default coupling ratios in the HP emulation mode for:

- span and resolution bandwidth (Span/RBW) and
- resolution bandwidth and video bandwidth (RBW/VBW)

This command is only available if a HP language is selected using [SYSTem:LANGuage](#) on page 915.

**Parameters:**

<CouplingType>      HP | FSP  
                           \*RST:      FSP

**Example:**            SYSTem:HPC HP

**Manual operation:** See "[Coupling](#)" on page 213

**SYSTem:IFGain:MODE** <Mode>

Configures the internal IF gain settings in HP emulation mode due to the application needs. This setting is only taken into account for resolution bandwidth < 300 kHz and is only available if a HP language is selected using [SYSTem:LANGuage](#) on page 915.

**Parameters:**

<Mode>                    NORM | PULS

**NORM**  
Optimized for high dynamic range, overload limit is close to reference level.

**PULS**  
Optimized for pulsed signals, overload limit up to 10 dB above reference level.

\*RST:                    NORM

**Example:**                    SYST:IFG:MODE PULS

**Manual operation:**    See "[IF Gain](#)" on page 212

**SYSTem:LANGuage** <Language>

This command selects the system language.

**Example:**                    SYST:LANG 'PSA'  
Emulates the PSA.

**Manual operation:**    See "[Language](#)" on page 212

**SYSTem:PSA:WIDeband** <State>

This command defines which option is returned when the \*OPT? query is executed, depending on the state of the wideband option.

It is only available for PSA89600 emulation.

**Parameters:**

<State>                    ON | OFF | HIGH

**OFF**  
The option is indicated as "B7J"

**ON**  
The 40 MHz wideband is used.  
The option is indicated as "B7J, 140".

**HIGH**  
The 80 MHz wideband is used.  
The option is indicated as "B7J, 122".

\*RST:                    OFF

**SYSTem:REVision[:STRing] <Name>**

Sets the response to the `REV?` query to the defined string (HP emulation only, see [SYSTem:LANGuage](#) on page 915).

**Parameters:**

<Name>

**Example:**

Define the system language:

```
SYST:LANG '8563E'
```

Query the revision:

```
REV?
```

Response:

```
920528
```

Set the response to 'NewRevision':

```
SYST:REV:STR 'NewRevision'
```

Query the response:

```
SYST:REV:STR?
```

Response:

```
NewRevision
```

**Manual operation:** See ["Revision String"](#) on page 213

**SYSTem:RSWEEP <State>**

Controls a repeated sweep of the E1 and MKPK HI HP model commands (for details on the commands refer to [Chapter 9.11.2, "Reference: GPIB Commands of Emulated HP Models"](#), on page 916). If the repeated sweep is OFF, the marker is set without sweeping before.

This command is only available if a HP language is selected using [SYSTem:LANGuage](#) on page 915

**Parameters:**

<State>

ON | OFF | 1 | 0

\*RST: 0

**Example:**

```
SYSTem:RSW ON
```

**Manual operation:** See ["Sweep Repeat"](#) on page 212

### 9.11.2 Reference: GPIB Commands of Emulated HP Models

The R&S FPL1000 analyzer family supports a subset of the GPIB commands of HP models 8560E, 8561E, 8562E, 8563E, 8564E, 8565E, 8566A, 8566B, 8568A, 8568B and 8594E.

Despite the differences in system architecture and device features, the supported commands have been implemented in a way to ensure a sufficiently high degree of correspondence with the original.

This includes the support of syntax rules for not only newer device families (B and E models) but for the previous A family as well.

In many cases the selection of commands supported by the R&S FPL1000 is sufficient to run an existing GPIB program without adaptation.

After the introduction, this section includes the following topics:

- [Command Set of Models 8560E, 8561E, 8562E, 8563E, 8564E, 8565E, 8566A/B, 8568A/B, 8591E, 8594E, 71100C, 71200C, and 71209A](#)..... 917
- [Special Features of the Syntax Parsing Algorithms for 8566A and 8568A Models](#)..... 940
- [Special Behavior of Commands](#)..... 941
- [Model-Dependent Default Settings](#)..... 942
- [Data Output Formats](#)..... 943
- [Trace Data Output Formats](#)..... 943
- [Trace Data Input Formats](#)..... 944
- [GPIB Status Reporting](#)..... 944

### 9.11.2.1 Command Set of Models 8560E, 8561E, 8562E, 8563E, 8564E, 8565E, 8566A/B, 8568A/B, 8591E, 8594E, 71100C, 71200C, and 71209A

As with the original units, the R&S FPL1000 includes the command set of the A models in the command set of the B models.



The HP model 8591E is compatible to HP model 8594E, the HP models 71100C, 71200C, and 71209A are compatible to HP models 8566A/B.

| Command             | Supported subset | Function               | Corresp. HP-Models                            | Status    |
|---------------------|------------------|------------------------|-----------------------------------------------|-----------|
| A1                  | A1               | Clear/Write A          | HP 8566A/<br>HP 8568A                         | available |
| A2                  | A2               | Max Hold A             | HP 8566A/<br>HP 8568A                         | available |
| A3                  | A3               | View A                 | HP 8566A/<br>HP 8568A                         | available |
| A4                  | A4               | Blank A                | HP 8566A/<br>HP 8568A                         | available |
| ABORT <sup>1)</sup> | ABORT            | Stop previous function | HP 856xE/<br>HP 8566B/HP<br>8568B/HP<br>8594E | available |
| ADD                 |                  | Add                    | HP 8566B/<br>HP 8568B/<br>HP 8594E            | available |

| Command              | Supported subset                                                  | Function               | Corresp. HP-Models                                                        | Status    |
|----------------------|-------------------------------------------------------------------|------------------------|---------------------------------------------------------------------------|-----------|
| ADJALL               | ADJALL                                                            | Adjust all             | HP 856xE/<br>HP 8566B/<br>HP 8568B/<br>HP 8594E                           | available |
| ADJCRT <sup>2)</sup> | ADJCRT                                                            | Adjust CRT             | HP 856xE/<br>HP 8566B/<br>HP 8568B/<br>HP 8594E                           | available |
| ADJIF <sup>2)</sup>  | ADJIF                                                             | Auto adjust IF         | HP 856xE/<br>HP 8566B/<br>HP 8568B/<br>HP 8594E                           | available |
| AMB                  | AMB ON OFF<br>AMB 1 0<br>AMB?                                     | Trace A – B -> Trace A | HP 856xE/<br>HP 8594E                                                     | available |
| AMBPL                | AMBPL ON OFF<br>AMBPL 1 0<br>AMBPL?                               |                        | HP 856xE/<br>HP 8566B/<br>HP 8568B/<br>HP 8594E                           | available |
| ANNOT                | ANNOT ON OFF<br>ANNOT 1 0<br>ANNOT?                               | Annotation             | HP 856xE/<br>HP 8566B/<br>HP 8568B/<br>HP 8594E                           | available |
| APB                  | APB                                                               | Trace A + B -> Trace A | HP 856xE/<br>HP 8566B/<br>HP 8568B/<br>HP 8594E                           | available |
| AT                   | AT <numeric_value> DB<br>  DM<br>AT DN<br>AT UP<br>AT AUTO<br>AT? | Attenuation            | HP 8566A/<br>HP 8568A/<br>HP 856xE/<br>HP 8566B/<br>HP 8568B/<br>HP 8594E | available |
| AUNITS               | AUNITS DBM   DBMV  <br>DBUV  <br>AUNITS?                          | Amplitude Units        | HP 856xE/<br>HP 8566B/<br>HP 8568B/<br>HP 8594E                           | available |

| Command | Supported subset  | Function                              | Corresp. HP-Models                              | Status    |
|---------|-------------------|---------------------------------------|-------------------------------------------------|-----------|
| AUTOCP  | AUTOCP            | Coupling default                      | HP 856xE/<br>HP 8566B/<br>HP 8568B/<br>HP 8594E | available |
| AXB     | AXB               | Exchange trace A and B                | HP 856xE/<br>HP 8566B/<br>HP 8568B/<br>HP 8594E | available |
| B1      | B1                | Clear/Write B                         | HP 8566A/<br>HP 8568A                           | available |
| B2      | B2                | Max Hold B                            | HP 8566A/<br>HP 8568A                           | available |
| B3      | B3                | View B                                | HP 8566A/<br>HP 8568A                           | available |
| B4      | B4                | Blank B                               | HP 8566A/<br>HP 8568A                           | available |
| BL      | BL                | Trace B – Display Line -<br>> Trace B | HP 8566A/<br>HP 8568A                           | available |
| BML     | BML               | Trace B – Display Line -<br>> Trace B | HP 856xE/<br>HP8594E                            | available |
| BTC     | BTC               | Transfer Trace B -> C                 | HP 856xE/<br>HP 8566B/<br>HP 8568B/<br>HP 8594E | available |
| BXC     | BXC               | Exchange Trace B and<br>C             | HP 856xE/<br>HP 8566B/<br>HP 8568B/<br>HP 8594E | available |
| BLANK   | BLANK TRA TRB TRC | Blank Trace                           | HP 856xE/<br>HP 8566B/<br>HP 8568B/<br>HP 8594E | available |
| C1      | C1                | A-B off                               | HP 8566A/<br>HP 8568A                           | available |
| C2      | C2                | A-B -> A                              | HP 8566A/<br>HP 8568A                           | available |
| CA      | CA                | Couple Attenuation                    | HP 8566A/<br>HP 8568A                           | available |

## Emulating Other Instruments' Commands

| Command           | Supported subset                                              | Function                      | Corresp. HP-Models                                                        | Status    |
|-------------------|---------------------------------------------------------------|-------------------------------|---------------------------------------------------------------------------|-----------|
| CAL <sup>1)</sup> | CAL ALL<br>CAL ON<br>CAL OFF                                  | Start analyzer self alignment | HP 856xE/<br>HP 8566B/<br>HP 8568B/<br>HP 8594E                           | available |
| CF                | CF <numeric_value><br>HZ KHZ MHZ GHZ<br>CF UP<br>CF DN<br>CF? | Center Frequency              | HP 8566A/<br>HP 8568A/<br>HP 856xE/<br>HP 8566B/<br>HP 8568B/<br>HP 8594E | available |
| CHANPWR           | CHANPWR TRA TRB,<br><numeric_value> ,?                        | Channel Power Measurement     | HP 856xE/<br>HP 8594E                                                     | available |
| CHPWRBW           | CHPWRBW<br><numeric_value> HZ <br>KHZ MHZ GHZ                 | Channel Power Bandwidth       | HP 856xE/<br>HP 8594E                                                     | available |
| CLRW              | CLRW TRA TRB TRC                                              | Clear/Write Trace             | HP 856xE/<br>HP 8566B/<br>HP 8568B/<br>HP 8594E                           | available |
| CLS <sup>1)</sup> | CLS                                                           | Clear all status bits         | HP 856xE/<br>HP 8566B/<br>HP 8568B/<br>HP 8594E                           | available |
| CONTS             | CONTS                                                         |                               | HP 856xE/<br>HP 8566B/<br>HP 8568B/<br>HP 8594E                           | available |
| COUPLE            | COUPLE AC DC                                                  | Input coupling                | HP 856xE/<br>HP 8566B/<br>HP 8568B/<br>HP 8594E                           | available |
| CR                | CR                                                            | Couple RBW                    | HP 8566A/<br>HP 8568A                                                     | available |
| CS                | CS                                                            | Couple Step Size              | HP 8566A/<br>HP 8568A                                                     | available |
| CT                | CT                                                            | Couple SWT                    | HP 8566A/<br>HP 8568A                                                     | available |
| CTA               |                                                               | Convert to absolute units     | HP 8566B/<br>HP 8568B/<br>HP 8594E                                        | available |



| Command                | Supported subset                                                        | Function            | Corresp. HP-Models                              | Status    |
|------------------------|-------------------------------------------------------------------------|---------------------|-------------------------------------------------|-----------|
| CV                     | CV                                                                      | Couple VBW          | HP 8566A/<br>HP 8568A                           | available |
| D1 <sup>2)</sup>       | D1                                                                      | Display Size normal | HP 8566A/<br>HP 8568A                           | available |
| DA <sup>2)</sup>       | DA                                                                      | Display address     |                                                 | available |
| DEMODO <sup>1)</sup>   | DEMODO ON OFF AM <br>FM                                                 | AF Demodulator      | HP 856xE/<br>HP 8566B/<br>HP 8568B/<br>HP 8594E | available |
| DEMODAGC <sup>2)</sup> | DEMODAGC ON OFF 1 <br>0<br>DEMODAGC?                                    | Demodulation AGC    | HP 856xE/<br>HP 8566B/<br>HP 8568B/<br>HP 8594E | available |
| DEMOT                  | DEMOT<br><numeric_value> S MS <br>US SC<br>DEMOT UP DN<br>DEMOT?        | Demodulation time   | HP 856xE/<br>HP 8566B/<br>HP 8568B/<br>HP 8594E | available |
| DET                    | DET POS SMP NEG<br>DET?                                                 | Detector            | HP 856xE/<br>HP 8566B/<br>HP 8568B/<br>HP 8594E | available |
| DISPOSE <sup>2)</sup>  | ONEOS   TRMATH  <br>ONSWP   ALL  <br><numeric_value>                    |                     |                                                 | available |
| DIV                    |                                                                         | Divide              | HP 8566B/<br>HP 8568B/<br>HP 8594E              | available |
| DL                     | DL <numeric_value><br>DB DM<br>DL DN<br>DL UP<br>DL ON<br>DL OFF<br>DL? | Display Line        | HP 856xE/<br>HP 8566B/<br>HP 8568B/<br>HP 8594E | available |
| DLE                    | DLE ON OFF                                                              | Display Line enable | HP 856xE/<br>HP 8566B/<br>HP 8568B/<br>HP 8594E | available |

## Emulating Other Instruments' Commands

| Command          | Supported subset                                                                                                                                                                                                                                                          | Function                                     | Corresp. HP-Models                                                        | Status            |
|------------------|---------------------------------------------------------------------------------------------------------------------------------------------------------------------------------------------------------------------------------------------------------------------------|----------------------------------------------|---------------------------------------------------------------------------|-------------------|
| DONE             | DONE<br>DONE?                                                                                                                                                                                                                                                             | Done query                                   | HP 856xE/<br>HP 8566B/<br>HP 8568B/<br>HP 8594E                           | available         |
| DW <sup>2)</sup> | DW                                                                                                                                                                                                                                                                        | Write to display and increment address       |                                                                           | available         |
| E1               | E1                                                                                                                                                                                                                                                                        | Peak Search                                  | HP 8566A/<br>HP 8568A                                                     | available         |
| E2               | E2                                                                                                                                                                                                                                                                        | Marker to Center Freq.                       | HP 8566A/<br>HP 8568A                                                     | available         |
| E3               | E3                                                                                                                                                                                                                                                                        | Deltamarker Step Size                        | HP 8566A/<br>HP 8568A                                                     | available         |
| E4               | E4                                                                                                                                                                                                                                                                        | Marker to Ref. Level                         | available                                                                 | available         |
| EDITDONE         |                                                                                                                                                                                                                                                                           | limit line edit done                         | HP 856xE                                                                  | available         |
| EDITLIML         |                                                                                                                                                                                                                                                                           | edit limit line                              | HP 856xE                                                                  | available         |
| ERR              | ERR 250 cal level error<br>ERR 300 LO unlock<br>ERR 472 cal error digital filter<br>ERR 473 cal error analog filter<br>ERR 552 cal error log amp<br>ERR 902 unscale tracking generator<br>ERR 906 oven cold<br>ERR 117 numeric unit error<br>ERR 112 Unrecognized Command | Now some FSx errors are mapped to HP errors. | HP8568A<br>HP856xE                                                        | not yet available |
| ERR?             | ERR?                                                                                                                                                                                                                                                                      | Error queue query                            | HP 856xE/<br>HP 8566B/<br>HP 8568B/<br>HP 8594E                           | not yet available |
| EX               | EX                                                                                                                                                                                                                                                                        | Exchange trace A and B                       | HP 8566A/<br>HP 8568A                                                     | available         |
| FA               | FA <numeric_value> HZ <br>KHZ MHZ GHZ<br>FA UP<br>FA DN<br>FA?                                                                                                                                                                                                            | Start Frequency                              | HP 8566A/<br>HP 8568A/<br>HP 856xE/<br>HP 8566B/<br>HP 8568B/<br>HP 8594E | available         |

| Command               | Supported subset                                               | Function                                                                | Corresp. HP-Models                                                        | Status    |
|-----------------------|----------------------------------------------------------------|-------------------------------------------------------------------------|---------------------------------------------------------------------------|-----------|
| FB                    | FB <numeric_value> HZ <br>KHZ MHZ GHZ<br>FB UP<br>FB DN<br>FB? | Stop Frequency                                                          | HP 8566A/<br>HP 8568A/<br>HP 856xE/<br>HP 8566B/<br>HP 8568B/<br>HP 8594E | available |
| FDSP                  |                                                                | Frequency display off                                                   | 8560E<br>8561E<br>8562E<br>8563E<br>8564E<br>8565E                        | available |
| FOFFSET <sup>1)</sup> | FOFFSET<br><numeric_value> HZ <br>KHZ MHZ GHZ<br>FOFFSET?      | Frequency Offset                                                        | HP 856xE/<br>HP 8566B/<br>HP 8568B/<br>HP 8594E                           | available |
| FREF                  | FREF INT EXT                                                   | Reference Frequency                                                     | HP 856xE/<br>HP 8566B/<br>HP 8568B/<br>HP 8594E                           | available |
| FS                    | FS                                                             | Full Span                                                               | HP 8566A/<br>HP 8568A                                                     | available |
| FUNCDEF               |                                                                | Define Function Function<br>must be in one line<br>between delimiters @ | HP 8594E/<br>HP 856xE/<br>HP 8566B                                        | available |
| GATE <sup>1)</sup>    | GATE ON OFF<br>GATE 1 0                                        |                                                                         | HP 856xE/<br>HP 8566B/<br>HP 8568B/<br>HP 8594E                           | available |
| GATECTL <sup>1)</sup> | GATECTL EDGE LEVEL<br>GATECTL?                                 |                                                                         | HP 856xE/<br>HP 8566B/<br>HP 8568B/<br>HP 8594E                           | available |
| GD <sup>1)</sup>      | GD <numeric_value><br>US MS SC<br>GD DN<br>GD UP<br>GD?        |                                                                         | HP 856xE/<br>HP 8566B/<br>HP 8568B/<br>HP 8594E                           | available |

## Emulating Other Instruments' Commands

| Command            | Supported subset                                                  | Function                            | Corresp. HP-Models                                                        | Status    |
|--------------------|-------------------------------------------------------------------|-------------------------------------|---------------------------------------------------------------------------|-----------|
| GL <sup>1)</sup>   | GL <numeric_value><br>US MS SC<br>GL DN<br>GL UP<br>GL?           |                                     | HP 856xE/<br>HP 8566B/<br>HP 8568B/<br>HP 8594E                           | available |
| GP <sup>1)</sup>   | GP POS NEG<br>GP?                                                 |                                     | HP 856xE/<br>HP 8566B/<br>HP 8568B/<br>HP 8594E                           | available |
| GRAT <sup>2)</sup> | GRAT<br>ON OFF                                                    | Graticule                           | HP 856xE/<br>HP 8566B/<br>HP 8568B/<br>HP 8594E                           | available |
| I1                 | I1                                                                |                                     | HP 8566A/<br>HP 8568A                                                     | available |
| I2                 | I2                                                                |                                     | HP 8566A/<br>HP 8568A                                                     | available |
| ID                 | ID<br>ID?                                                         | Identify                            | HP 8566A/<br>HP 8568A/<br>HP 856xE/<br>HP 8566B/<br>HP 8568B/<br>HP 8594E | available |
| INZ <sup>1)</sup>  | INZ 75<br>INZ 50<br>INZ?                                          | Input Impedance                     | HP 856xE/<br>HP 8566B/<br>HP 8568B/<br>HP 8594E                           | available |
| IP                 | IP                                                                | Instrument preset                   | HP 8566A/<br>HP 8568A                                                     | available |
| KEYDEF             | KEYDEF                                                            | Key definition                      | HP 8566B/<br>HP 856xE/<br>HP 859xE                                        | available |
| KEYEXEC            | KEYEXEC                                                           | Key execute                         | HP 8566B                                                                  | available |
| KS=                | KS= <numeric_value><br>HZ KHZ MHZ GHZ<br>KS= DN<br>KS= UP<br>KS=? | Marker Frequency Counter Resolution | HP 8566A/<br>HP 8568A                                                     | available |
| KS/                | KS/                                                               | Manual Peaking                      | HP 8566A/<br>HP 8568A                                                     | available |

## Emulating Other Instruments' Commands

| Command           | Supported subset                              | Function                | Corresp. HP-Models    | Status    |
|-------------------|-----------------------------------------------|-------------------------|-----------------------|-----------|
| KS(               | KS(                                           | Lock register           | HP 8566A/<br>HP 8568A | available |
| KS)               | KS)                                           | Unlock register         | HP 8566A/<br>HP 8568A | available |
| KS91              | KS91                                          | Read Amplitude Error    | HP 8566A/<br>HP 8568A | available |
| KSA               | KSA                                           | Amplitude Units in dBm  | HP 8566A/<br>HP 8568A | available |
| KSB               | KSB                                           | Amplitude Units in dBmV | HP 8566A/<br>HP 8568A | available |
| KSC               | KSC                                           | Amplitude Units in dBuV | HP 8566A/<br>HP 8568A | available |
| KSD               | KSD                                           | Amplitude Units in V    | HP 8566A/<br>HP 8568A | available |
| KSE               | KSE <numeric_value> <br><char data>@          | Title mode              | HP 8566A/<br>HP 8568A | available |
| KSG               | KSG<br>KSG ON<br>KSG <numeric_value>          | Video Averaging on      | HP 8566A/<br>HP 8568A | available |
| KSH               | KSH                                           | Video Averaging Off     | HP 8566A/<br>HP 8568A | available |
| KSK               |                                               | Marker to Next Peak     | HP 8566A/<br>HP 8568A | available |
| KSL               |                                               | Marker Noise off        | HP 8566A/<br>HP 8568A | available |
| KSM               |                                               | Marker Noise on         | HP 8566A/<br>HP 8568A | available |
| KSO               | KSO                                           | Deltamarker to span     | HP 8566A/<br>HP 8568A | available |
| KSP               | KSP <numeric_value>                           | HPIB address            | HP 8566A/<br>HP 8568A | available |
| KSQ <sup>2)</sup> | KSQ                                           | Band lock off           | HP 8566A/<br>HP 8568A | available |
| KST               | KST                                           | Fast Preset             | HP 8566A/<br>HP 8568A | available |
| KSV               | KSV <numeric_value><br>HZ KHZ MHZ GHZ<br>KSV? | Frequency Offset        | HP 8566A/<br>HP 8568A | available |

## Emulating Other Instruments' Commands

| Command           | Supported subset                  | Function                 | Corresp. HP-Models    | Status    |
|-------------------|-----------------------------------|--------------------------|-----------------------|-----------|
| KSW               | KSW                               | Error Correction Routine | HP 8566A/<br>HP 8568A | available |
| KSX               | KSX                               | Correction Values On     | HP 8566A/<br>HP 8568A | available |
| KSY               | KSY                               | Correction Values Off    | HP 8566A/<br>HP 8568A | available |
| KSZ               | KSZ <numeric_value><br>DB<br>KSZ? | Reference Value Offset   | HP 8566A/<br>HP 8568A | available |
| KSa               | KSa                               | Normal Detection         | HP 8566A/<br>HP 8568A | available |
| KSb               | KSb                               | Pos Peak Detection       | HP 8566A/<br>HP 8568A | available |
| KSd               | KSd                               | Neg Peak Detection       | HP 8566A/<br>HP 8568A | available |
| KSe               | KSe                               | Sample Detection         | HP 8566A/<br>HP 8568A | available |
| KSg               |                                   | CRT beam off             |                       | available |
| KSh               |                                   | CRT beam on              |                       | available |
| KSj               | KSj                               | View Trace C             | HP 8566A/<br>HP 8568A | available |
| KSk               | KSk                               | Blank Trace C            | HP 8566A/<br>HP 8568A | available |
| KSl               | KSl                               | Transfer B to C          | HP 8566A/<br>HP 8568A | available |
| KSm               | KSm                               | Graticule off            | HP 8566A/<br>HP 8568A | available |
| KSn <sup>2)</sup> | KSn                               | Grid on                  | HP 8566A/<br>HP 8568A | available |
| KSo               | KSn                               | Character display off    | HP 8566A/<br>HP 8568A | available |
| KSp               | KSp                               | Character display on     | HP 8566A/<br>HP 8568A | available |
| KSr               | KSr                               | Create service request   | HP 8566A/<br>HP 8568A | available |
| KSt <sup>2)</sup> | KSt                               | Band lock on             | HP 8566A/<br>HP 8568A | available |

| Command           | Supported subset                     | Function                       | Corresp. HP-Models                              | Status    |
|-------------------|--------------------------------------|--------------------------------|-------------------------------------------------|-----------|
| KSv <sup>2)</sup> | KSv                                  | Signal ident on                | HP 8566A/<br>HP 8568A                           | available |
| L0                | L0                                   | Display line off               | HP 8566A/<br>HP 8568A                           | available |
| LB                | LB <numeric_value> <br><char data>@  | Label                          | HP 8566A/<br>HP 8568A                           | available |
| LF                | LF                                   | Low frequency band pre-<br>set | HP 8566A/<br>HP 8568A                           | available |
| LIMD              |                                      | limit line delta               | HP 856xE                                        | available |
| LIMF              |                                      | limit line frequency           | HP 856xE                                        | available |
| LIMIFAIL          |                                      | limit fail query               | HP 856xE                                        | available |
| LIMIPURGE         |                                      | purge limit line               | HP 856xE                                        | available |
| LIMIRCL           |                                      | recall limit line              | HP 856xE                                        | available |
| LIMIREL           |                                      | relative limit line            | HP 856xE                                        | available |
| LIMISAV           |                                      | save limit line                | HP 856xE                                        | available |
| LIMITEST          |                                      | limit line test                | HP 856xE                                        | available |
| LIML              |                                      | lower limit line value         | HP 856xE                                        | available |
| LIMM              |                                      | middle limit line value        | HP 856xE                                        | available |
| LIMTFL            |                                      | flat limit line segment        | HP 856xE                                        | available |
| LIMTSL            |                                      | slope limit line segment       | HP 856xE                                        | available |
| LIMU              |                                      | upper limit line value         | HP 856xE                                        | available |
| LG                | LG <numeric_value> DB<br>  DM<br>LG? | Amplitude Scale Log            | HP 856xE/<br>HP 8566B/<br>HP 8568B/<br>HP 8594E | available |
| LL <sup>2)</sup>  | LL                                   | Plot command                   | HP 8566A/<br>HP 8568A                           | available |
| LN                | LN                                   | Amplitude Scale Lin            | HP 856xE/<br>HP 8566B/<br>HP 8568B/<br>HP 8594E | available |
| M1                | M1                                   | Marker Off                     | HP 8566A/<br>HP 8568A                           | available |

| Command            | Supported subset                                                    | Function                 | Corresp. HP-Models                                                        | Status        |
|--------------------|---------------------------------------------------------------------|--------------------------|---------------------------------------------------------------------------|---------------|
| M2                 | M2<br>M2 <numeric_value><br>HZ KHZ MHZ GHZ<br>M2 DN<br>M2 UP<br>M2? | Marker Normal            | HP 8566A/<br>HP 8568A                                                     | available     |
| M3                 | M3<br>M3 <numeric_value><br>HZ KHZ MHZ GHZ<br>M3 DN<br>M3 UP<br>M3? | Delta Marker             | HP 8566A/<br>HP 8568A                                                     | available     |
| M4                 | M4 <numeric_value><br>HZ KHZ MHZ GHZ                                | Marker Zoom              | HP 8566A/<br>HP 8568A                                                     | available     |
| MA                 | MA                                                                  | Marker Amplitude         | HP 8566A/<br>HP 8568A                                                     | available     |
| MC0                | MC0                                                                 | Marker Count off         | HP 8566A/<br>HP 8568A                                                     | available     |
| MC1                | MC1                                                                 | Marker Count on          | HP 8566A/<br>HP 8568A                                                     | available     |
| MDS                | MDS                                                                 | Measurement data size    | HP 8566B                                                                  | available     |
| MEAS               |                                                                     | Measurement status       | HP 856xE                                                                  | available     |
| MF                 | MF<br>MF?                                                           | Marker Frequency         | HP 8566A/<br>HP 8568A/<br>HP 856xE/<br>HP 8566B/<br>HP 8568B/<br>HP 8594E | available     |
| MINH <sup>1)</sup> | MINH TRC                                                            | Minimum Hold             | HP 856xE/<br>HP 8566B/<br>HP 8568B/<br>HP 8594E                           | available     |
| MKA                | MKA <numeric_value><br>MKA?                                         | Marker Amplitude         | HP 856xE/<br>HP 8566B/<br>HP 8568B/<br>HP 8594E                           | available     |
| MKACT              | MKACT 1<br>MKACT?                                                   | Select the active marker | HP 856xE/<br>HP 8566B/<br>HP 8568B/<br>HP 8594E                           | not available |



## Emulating Other Instruments' Commands

| Command             | Supported subset                                                                                  | Function                     | Corresp. HP-Models                              | Status    |
|---------------------|---------------------------------------------------------------------------------------------------|------------------------------|-------------------------------------------------|-----------|
| MKBW <sup>1)</sup>  | MKBW <numeric_value><br>MKBW ON<br>MKBW OFF                                                       | N dB Down                    | HP 856xE/<br>HP 8566B/<br>HP 8568B/<br>HP 8594E | available |
| MKD                 | MKD<br>MKD <numeric_value><br>HZ KHZ <br>MHZ GHZ<br>MKD DN<br>MKD UP<br>MKD ON<br>MKD OFF<br>MKD? | Delta Marker                 | HP 856xE/<br>HP 8566B/<br>HP 8568B/<br>HP 8594E | available |
| MKDR                | MKDR <numeric_value><br>HZ KHZ <br>MHZ GHZ <br>S SC MS MSEC <br>USMKDR?                           | Delta Marker reverse         | HP 856xE/<br>HP 8566B/<br>HP 8568B/<br>HP 8594E | available |
| MKDR?               |                                                                                                   | Delta Marker reverse query   |                                                 | available |
| MKF                 | MKF <numeric_value><br>HZ KHZ MHZ GHZ<br>MKF?                                                     | Set Marker Frequency         | HP 856xE/<br>HP 8566B/<br>HP 8568B/<br>HP 8594E | available |
| MKFC                | MKFC ON OFF                                                                                       | Frequency Counter on/off     | HP 856xE/<br>HP 8566B/<br>HP 8568B/<br>HP 8594E | available |
| MKFCR <sup>1)</sup> | MKFCR<br><numeric_value><br>HZ KHZ  MHZ GHZ<br>MKFCR DN<br>MKFCR UP<br>MKFCR?                     | Frequency Counter Resolution | HP 856xE/<br>HP 8566B/<br>HP 8568B/<br>HP 8594E | available |
| MKMIN               | MKMIN                                                                                             | Marker -> Min                | HP 856xE/<br>HP 8566B/<br>HP 8568B/<br>HP 8594E | available |

| Command | Supported subset                                                                              | Function                 | Corresp. HP-Models                              | Status    |
|---------|-----------------------------------------------------------------------------------------------|--------------------------|-------------------------------------------------|-----------|
| MKN     | MKN<br>MKN <numeric_value><br>HZ KHZ MHZ GHZ<br>MKN DN<br>MKN UP<br>MKN ON<br>MKN OFF<br>MKN? | Normal Marker            | HP 856xE/<br>HP 8566B/<br>HP 8568B/<br>HP 8594E | available |
| MKNOISE | MKNOISE ON OFF<br>MKNOISE 1 0<br>MKNOISE?                                                     | Noise Measurement        | HP 856xE/<br>HP 8566B/<br>HP 8568B/<br>HP 8594E | available |
| MKOFF   | MKOFF<br>MKOFF ALL                                                                            | Marker off               | HP 856xE/<br>HP 8566B/<br>HP 8568B/<br>HP 8594E | available |
| MKP     | MKP <numeric_value><br>MKP?                                                                   | Marker position          | HP 856xE/<br>HP 8566B/<br>HP 8568B/<br>HP 8594E | available |
| MKPK    | MKPK<br>MKPK HI<br>MKPK NH<br>MKPK NR<br>MKPK NL                                              | Marker Search            | HP 856xE/<br>HP 8566B/<br>HP 8568B/<br>HP 8594E | available |
| MKPT    | MKPT<br>MKPT HI<br>MKPT NH<br>MKPT NR<br>MKPT NL                                              | Marker Peak Threshold    | HP 856xE/<br>HP 8566B/<br>HP 8568B/<br>HP 8594E | available |
| MKPX    | MKPX <numeric_value><br>DB<br>MKPX DN<br>MKPX UP<br>MKPX?                                     | Peak Excursion           | HP 856xE/<br>HP 8566B/<br>HP 8568B/<br>HP 8594E | available |
| MKRL    | MKRL                                                                                          | Ref Level = Marker Level | HP 856xE/<br>HP 8566B/<br>HP 8568B/<br>HP 8594E | available |

| Command | Supported subset                          | Function                        | Corresp. HP-Models                              | Status    |
|---------|-------------------------------------------|---------------------------------|-------------------------------------------------|-----------|
| MKSP    | MKSP                                      | Deltamarker to span             | HP 856xE/<br>HP 8566B/<br>HP 8568B/<br>HP 8594E | available |
| MKSS    | MKSS                                      | CF Stepsize = Marker Freq       | HP 856xE/<br>HP 8566B/<br>HP 8568B/<br>HP 8594E | available |
| MKT     | MKT <numeric_value><br>S MS US SC<br>MKT? | MKF = fstart + MKT/<br>SWT*Span | HP 856xE/<br>HP 8594E                           | available |
| MKTRACE | MKTRACE TRA TRB <br>TRC                   | Marker to Trace                 | HP 856xE/<br>HP 8566B/<br>HP 8568B/<br>HP 8594E | available |
| MKTRACK | MKTRACK ON OFF<br>MKTRACK 1 0<br>MKTRACK? | Signal Track                    | HP 856xE/<br>HP 8566B/<br>HP 8568B/<br>HP 8594E | available |
| MKTYPE  | MKTYPE AMP<br>MK TYPE?                    | Marker type                     | HP 856xE/<br>HP 8566B/<br>HP 8568B/<br>HP 8594E | available |
| ML      |                                           | Mixer level                     | HP 856xE                                        | available |
| MOV     | MOV TRA TRB TRC,<br>TRA TRB T RC          | Move Trace Contents             | HP 856xE/<br>HP 8566B/<br>HP 8568B/<br>HP 8594E | available |
| MPY     |                                           | Multiply                        | HP 8566B/<br>HP 8568B/<br>HP 8594E              | available |
| MT0     | MT0                                       | Marker Track Off                | HP 8566A/<br>HP 8568A                           | available |
| MT1     | MT1                                       | Marker Track On                 | HP 8566A/<br>HP 8568A                           | available |
| MXMH    | MXMH TRA TRB                              | Maximum Hold                    | HP 856xE/<br>HP 8566B/<br>HP 8568B/<br>HP 8594E | available |

## Emulating Other Instruments' Commands

| Command           | Supported subset                       | Function                                | Corresp. HP-Models                              | Status                     |
|-------------------|----------------------------------------|-----------------------------------------|-------------------------------------------------|----------------------------|
| NORMALIZE         | NORMALIZE                              | Normalize trace                         | HP 856xE/<br>HP 8566B/<br>HP 8568B/<br>HP 8594E | not available<br>available |
| NRL <sup>1)</sup> | NRL <numeric_value><br>DB   DM<br>NRL? | Normalized Reference Level              | HP 856xE/<br>HP 8566B/<br>HP 8568B/<br>HP 8594E | available                  |
| NRPOS             | NRPOS<br><numeric_value><br>NRL?       | Normalize position                      | HP 856xE/<br>HP 8566B/<br>HP 8568B/<br>HP 8594E | available                  |
| O1                | O1                                     | Format ASCII, Values 0 to 4095          | HP 8566A/<br>HP 8568A                           | available                  |
| O2                | O2                                     | Format Binary, Values 0 to 4095         | HP 8566A/<br>HP 8568A                           | available                  |
| O3                | O3                                     | Format ASCII                            | HP 8566A/<br>HP 8568A                           | available                  |
| OA                | OA                                     | Output All                              | HP 8566A/<br>HP 8568A                           | available                  |
| OL                | OL <80 characters><br>OL?              | Output Learn String                     | HP 8566A/<br>HP 8568A                           | available                  |
| OT                | OT                                     | Output Trace Annotations                | HP 8566A/<br>HP 8568A                           | available                  |
| PA                | PA <numeric_value>,<br><numeric_value  | Plot command                            | HP 8566A/<br>HP 8568A                           | available                  |
| PD                | PD <numeric_value>,<br><numeric_value  | Plot command                            | HP 8566A/<br>HP 8568A                           | available                  |
| PH_MKF            |                                        | Spot frequency in Hz                    | HP 856xE                                        | available                  |
| PH_FMIN           |                                        | Min offset frequency to be measured     | HP 856xE                                        | available                  |
| PH_FMAX           |                                        | Max offset frequency to be measured     | HP 856xE                                        | available                  |
| PH_MKA            |                                        | Queries amplitude at the spot frequency | HP 856xE                                        | available                  |
| PH_DRIFT          |                                        | 0: for stable signals, 1: for drifty    | HP 856xE                                        | available                  |
| PH_RLVL           |                                        | Reference level for the log plot        | HP 856xE                                        | available                  |

| Command               | Supported subset                         | Function                                                 | Corresp. HP-Models                              | Status    |
|-----------------------|------------------------------------------|----------------------------------------------------------|-------------------------------------------------|-----------|
| PH_SMTHV              |                                          | Trace smoothing                                          | HP 856xE                                        | available |
| PH_VBR                |                                          | Filtering                                                | HP 856xE                                        | available |
| PH_RMSPT              |                                          | Amount of data points to skip when doing the integration | HP 856xE                                        | available |
| PH_RMSFL              |                                          | Lower integration frequency in Hz                        | HP 856xE                                        | available |
| PH_RMSFU              |                                          | Upper integration frequency in Hz                        | HP 856xE                                        | available |
| PH_EXIT               |                                          | Quits phase noise                                        | HP 856xE                                        | available |
| PH_F_UDT              |                                          | Updates internal frequency variables                     | HP 856xE                                        | available |
| PH_LMT_L              |                                          | Apply limits to PH_FMIN and PH_FMAX                      | HP 856xE                                        | available |
| PH_MEAS               |                                          | Generates log frequency plot                             | HP 856xE                                        | available |
| PH_MKF_D              |                                          | Updates the spot frequency                               | HP 856xE                                        | available |
| PH_RMS                |                                          | Requests the rms phase noise                             | HP 856xE                                        | available |
| PH_RMSFT              |                                          | Updates internal frequency variables                     | HP 856xE                                        | available |
| PH_RMSX               |                                          | Calculates the rms phase noise                           | HP 856xE                                        | available |
| PH_SPOTF              |                                          | Executes the spot frequency measurement                  | HP 856xE                                        | available |
| PLOTORG <sup>2)</sup> | PLOTORG DSP GRT                          | Plot command                                             | HP 856xE/<br>HP 8566B/<br>HP 8568B/<br>HP 8594E | available |
| PLOTSRC <sup>2)</sup> | PLOTSRC ANNT GRT <br>TRB  TRA ALLDSP GRT | Plot command                                             | HP 856xE/<br>HP 8566B/<br>HP 8568B/<br>HP 8594E | available |
| PP                    | PP                                       | Preselector Peaking                                      | HP 8566A/<br>HP 8568A                           | available |
| PRINT <sup>1)</sup>   | PRINT<br>PRINT 1 0                       | Hardcopy                                                 | HP 856xE/<br>HP 8566B/<br>HP 8568B/<br>HP 8594E | available |

## Emulating Other Instruments' Commands

| Command              | Supported subset                                                         | Function                   | Corresp. HP-Models                              | Status    |
|----------------------|--------------------------------------------------------------------------|----------------------------|-------------------------------------------------|-----------|
| PSDAC <sup>2)</sup>  | PSDAC<br><numeric_value><br>PSDAC UP DN                                  | Preselector DAC value      | HP 856xE/<br>HP 8566B/<br>HP 8568B/<br>HP 8594E | available |
| PSTATE <sup>2)</sup> | PSTATE ON OFF 1 0                                                        | Protect State              | HP 856xE/<br>HP 8566B/<br>HP 8568B/<br>HP 8594E | available |
| PU                   | PU                                                                       | Pen Up                     | HP 8566A/<br>HP 8568A                           | available |
| PWRBW                | PWRBW                                                                    | Power Bandwidth            | HP 8566B/<br>HP 859x/<br>HP 856xE               | available |
| R1                   | R1                                                                       | Set Status Bit Enable      | HP 8566A/<br>HP 8568A                           | available |
| R2                   | R2                                                                       | Set Status Bit Enable      | HP 8566A/<br>HP 8568A                           | available |
| R3                   | R3                                                                       | Set Status Bit Enable      | HP 8566A/<br>HP 8568A                           | available |
| R4                   | R4                                                                       | Set Status Bit Enable      | HP 8566A/<br>HP 8568A                           | available |
| RB                   | RB <numeric_value><br>HZ KHZ MHZ GHZ<br>RB DN<br>RB UP<br>RB AUTO<br>RB? | Resolution Bandwidth       | HP 856xE/<br>HP 8566B/<br>HP 8568B/<br>HP 8594E | available |
| RBR                  | RBR <numeric_value><br>RBR DN<br>RBR UP<br>RBR?                          | Resolution Bandwidth Ratio | HP 856xE/<br>HP 8566B/<br>HP 8568B/<br>HP 8594E | available |
| RC1...6              | RC1...6                                                                  | Recall Last State          | HP 8566A/<br>HP 8568A                           | available |
| RCLS                 | RCLS <numeric_value>                                                     | Recall State Register      | HP 856xE/<br>HP 8566B/<br>HP 8568B/<br>HP 8594E | available |
| RCLT                 | RCLT TRA TRB, <number>                                                   | Recall Trace               | HP856xE/<br>HP8594E                             | available |

| Command             | Supported subset                                           | Function                    | Corresp. HP-Models                              | Status        |
|---------------------|------------------------------------------------------------|-----------------------------|-------------------------------------------------|---------------|
| RESET               | RESET                                                      | Instrument preset           | HP 856xE/<br>HP 8566B/<br>HP 8568B/<br>HP 8594E | available     |
| REV                 | REV<br>REV?                                                | Firmware revision           | HP 856xE/<br>HP 8566B/<br>HP 8568B/<br>HP 8594E | available     |
| RL                  | RL <numeric_value><br>DB DM<br>RL DN<br>RL UP<br>RL?       | Reference Level             | HP 856xE/<br>HP 8566B/<br>HP 8568B/<br>HP 8594E | available     |
| RLCAL               | RLCAL<br><numeric_value><br>RL?                            | Reference Level Calibration | HP 856xE/<br>HP 8566B/<br>HP 8568B/<br>HP 8594E | available     |
| RCLOSCAL            | RCLOSCAL                                                   | Recall Open/Short Average   | HP 856xE/<br>HP 8594E                           | not available |
| RCLTHRU             | RCLTHRU                                                    | Recall Thru                 | HP 856xE/<br>HP 8594E                           | not available |
| RLPOS <sup>1)</sup> | RLPOS<br><numeric_value><br>RLPOS DN<br>RLPOS UP<br>RLPOS? | Reference Level Position    | HP 856xE/<br>HP 8566B/<br>HP 8568B/<br>HP 8594E | available     |
| ROFFSET             | ROFFSET<br><numeric_value> DB  <br>DM<br>ROFFSET?          | Reference Level Offset      | HP 856xE/<br>HP 8566B/<br>HP 8568B/<br>HP 8594E | available     |
| RQS                 | RQS                                                        | Service Request Bit mask    | HP 856xE/<br>HP 8566B/<br>HP 8568B/<br>HP 8594E | available     |
| S1                  | S1                                                         | Continuous Sweep            | HP 8566A/<br>HP 8568A                           | available     |
| S2                  | S2                                                         | Single Sweep                | HP 8566A/<br>HP 8568A                           | available     |
| SADD                |                                                            | add a limit line segment    | HP 856xE                                        | available     |

| Command               | Supported subset                                                              | Function                  | Corresp. HP-Models                                                        | Status        |
|-----------------------|-------------------------------------------------------------------------------|---------------------------|---------------------------------------------------------------------------|---------------|
| SAVES                 | SAVES<br><numeric_value>                                                      | Save State Register       | HP 856xE/<br>HP 8566B/<br>HP 8568B/<br>HP 8594E                           | available     |
| SAVET                 | SAVET TRA TRB,<num-<br>ber>                                                   | Save Trace                | HP856xE/<br>HP8594E                                                       | available     |
| SDEL                  |                                                                               | delete limit line segment | HP 856xE                                                                  | available     |
| SDON                  |                                                                               | limit line segment done   | HP 856xE                                                                  | available     |
| SEDI                  |                                                                               | edit limit line segment   | HP 856xE                                                                  | available     |
| SMOOTH                | SMOOTH TRA TRB <br>TRC, <number of<br>points>                                 | Smooth Trace              | HP 856xE/<br>HP 8566B/<br>HP 8568B/<br>HP 8594E                           | available     |
| SNGLS                 | SNGLS                                                                         | Single Sweep              | HP 856xE/<br>HP 8566B/<br>HP 8568B/<br>HP 8594E                           | available     |
| SQUELCH <sup>2)</sup> | SQUELCH<br><numeric_value><br>DM   DB<br>SQUELCH UP DN<br>SQUELCH ON OFF      | Squelch                   | HP 856xE/<br>HP 8566B/<br>HP 8568B/<br>HP 8594E                           | available     |
| SP                    | SP <numeric_value><br>HZ KHZ MHZ GHZ<br>SP DN<br>SP UP<br>SP?                 | Span                      | HP 8566A/<br>HP 8568A/<br>HP 856xE/<br>HP 8566B/<br>HP 8568B/<br>HP 8594E | available     |
| SRCNORM <sup>1)</sup> | SRCNORM ON OFF<br>SRCNORM 1 0                                                 | Source Normalization      | HP 856xE/<br>HP 8566B/<br>HP 8568B/<br>HP 8594E                           | not available |
| SRCPOFS <sup>1)</sup> | SRCPOFS<br><numeric_value> DB  <br>DM<br>SRCPOFS DN<br>SRCPOFS UP<br>SRCPOFS? | Source Power Offset       | HP 856xE/<br>HP 8566B/<br>HP 8568B/<br>HP 8594E                           | not available |



| Command              | Supported subset                                                                                     | Function                | Corresp. HP-Models                                                        | Status        |
|----------------------|------------------------------------------------------------------------------------------------------|-------------------------|---------------------------------------------------------------------------|---------------|
| SRCPWR <sup>1)</sup> | SRCPWR<br><numeric_value> DB  <br>DM<br>SRCPWR DN<br>SRCPWR UP<br>SRCPWR ON<br>SRCPWR OFF<br>SRCPWR? | Source Power            | HP 856xE/<br>HP 8566B/<br>HP 8568B/<br>HP 8594E                           | not available |
| SS                   | SS <numeric_value><br>HZ KHZ MHZ GHZ<br>SS DN<br>SS UP<br>SS AUTO<br>SS?                             | CF Step Size            | HP 8566A/<br>HP 8568A/<br>HP 856xE/<br>HP 8566B/<br>HP 8568B/<br>HP 8594E | available     |
| ST                   | ST <numeric_value><br>US MS SC<br>ST DN<br>ST UP<br>ST AUTO<br>ST?                                   | Sweep Time              | HP 8566A/<br>HP 8568A/<br>HP 856xE/<br>HP 8566B/<br>HP 8568B/<br>HP 8594E | available     |
| STB                  | STB                                                                                                  | Status byte query       | HP 856xE/<br>HP 8566B/<br>HP 8568B/<br>HP 8594E                           | available     |
| STOREOPEN            | STOREOPEN                                                                                            | Store Open              | HP 856xE/<br>HP 8594E                                                     | not available |
| STORESHORT           | STORESHORT                                                                                           | Store Short             | HP 856xE/<br>HP 8594E                                                     | not available |
| STORETHRU            | STORETHRU                                                                                            | Store Thru              | HP 856xE/<br>HP 8594E                                                     | not available |
| SUB                  |                                                                                                      | Subtract                | HP 8566B/<br>HP 8568B/<br>HP 8594E                                        | available     |
| SUM                  |                                                                                                      | sum of trace amplitudes | HP 8566B/<br>HP 8568B/<br>HP 8594E                                        | available     |
| SV1...6              | SV1...6                                                                                              | Save State              | HP 8566A/<br>HP 8568A                                                     | available     |

| Command              | Supported subset                          | Function                                                                                             | Corresp. HP-Models                              | Status        |
|----------------------|-------------------------------------------|------------------------------------------------------------------------------------------------------|-------------------------------------------------|---------------|
| SWPCPL <sup>2)</sup> | SWPCPL SA   SR<br>SWPCPL?                 | Sweep Couple                                                                                         | HP 856xE/<br>HP 8566B/<br>HP 8568B/<br>HP 8594E | available     |
| SWPOUT <sup>2)</sup> | SWPOUT FAV FAVA <br>RAMP<br>SWPOUT?       | Sweep Output                                                                                         | HP 856xE/<br>HP 8566B/<br>HP 8568B/<br>HP 8594E | available     |
| T0                   | T0                                        | Threshold off                                                                                        | HP 8566A/<br>HP 8568A                           | available     |
| T1                   | T1                                        | Free Run Trigger                                                                                     | HP 8566A/<br>HP 8568A                           | available     |
| T2 <sup>2)</sup>     | T2                                        | Line Trigger                                                                                         | HP 8566A/<br>HP 8568A                           | available     |
| T3                   | T3                                        | External Trigger                                                                                     | HP 8566A/<br>HP 8568A                           | available     |
| T4                   | T4                                        | Video Trigger                                                                                        | HP 8566A/<br>HP 8568A                           | available     |
| TA                   | TA                                        | Transfer A                                                                                           | HP 8566A/<br>HP 8568A                           | available     |
| TACL                 | TACL?                                     | Returns instantaneous measurement results. See TRACe<trace #>:IMMediate:LEVel? for full description. |                                                 | not available |
| TBCL                 | TBCL?                                     |                                                                                                      |                                                 |               |
| TCCL                 | TCCL?                                     |                                                                                                      |                                                 |               |
| TACR                 | TACR?                                     | Returns instantaneous measurement results. See TRACe<trace #>:IMMediate:LEVel? for full description. |                                                 | not available |
| TBCR                 | TBCR?                                     |                                                                                                      |                                                 |               |
| TCCR                 | TCCR?                                     |                                                                                                      |                                                 |               |
| TB                   | TB                                        | Transfer B                                                                                           | HP 8566A/<br>HP 8568A                           | available     |
| TDF                  | TDF P<br>TDF M<br>TDF B<br>TDF A<br>TDF I | Trace Data Format                                                                                    | HP 856xE/<br>HP 8566B/<br>HP 8568B/<br>HP 8594E | available     |

| Command               | Supported subset                                                                   | Function              | Corresp. HP-Models                              | Status    |
|-----------------------|------------------------------------------------------------------------------------|-----------------------|-------------------------------------------------|-----------|
| TH                    | TH <numeric_value><br>DB DM<br>TH DN<br>TH UP<br>TH ON<br>TH OFF<br>TH AUTO<br>TH? | Threshold             | HP 856xE/<br>HP 8566B/<br>HP 8568B/<br>HP 8594E | available |
| THE                   | THE ON  OFF                                                                        | Threshold Line enable | HP 856xE/<br>HP 8566B/<br>HP 8568B/<br>HP 8594E | available |
| TIMEDSP <sup>1)</sup> | TIMEDSP ON OFF<br>TIMEDSP 1 0<br>TIMEDSP?                                          | Time Display          | HP 856xE/<br>HP 8566B/<br>HP 8568B/<br>HP 8594E | available |
| TM                    | TM FREE VID EXT <br>LINE <sup>2)</sup><br>TM?                                      | Trigger Mode          | HP 856xE/<br>HP 8566B/<br>HP 8568B/<br>HP 8594E | available |
| TM LINE <sup>2)</sup> | TM LINE                                                                            | Trigger Line          | HP 8566B                                        | available |
| TRA                   | TRA B<br>TRA A<br>TRA I                                                            | Transfer A            | HP 856xE/<br>HP 8566B/<br>HP 8568B/<br>HP 8594E | available |
| TRB                   | TRB B<br>TRB A<br>TRB I                                                            | Transfer B            | HP 856xE/<br>HP 8566B/<br>HP 8568B/<br>HP 8594E | available |
| TRSTAT                | TRSTAT?                                                                            | Trace State Query     | HP 856xE/<br>HP 8566B/<br>HP 8568B/<br>HP 8594E | available |
| TS                    | TS                                                                                 | Take Sweep            | HP 856xE/<br>HP 8566B/<br>HP 8568B/<br>HP 8594E | available |
| UR <sup>2)</sup>      | UR                                                                                 | Plot Command          | HP 8566A/<br>HP 8568A                           | available |

| Command                                                      | Supported subset                                                         | Function                                         | Corresp. HP-Models                              | Status        |
|--------------------------------------------------------------|--------------------------------------------------------------------------|--------------------------------------------------|-------------------------------------------------|---------------|
| VARDEF                                                       | VARDEF                                                                   | Variable definition,<br>arrays are not supported | HP 8566B/<br>HP 8568B/<br>HP 8594E              | available     |
| VAVG                                                         | VAVG<br>VAVG TRA TRB TRC                                                 | Video Averaging                                  | HP 856xE/<br>HP 8566B/<br>HP 8568B/<br>HP 8594E | available     |
| VB                                                           | VB <numeric_value><br>HZ KHZ MHZ GHZ<br>VB DN<br>VB UP<br>VB AUTO<br>VB? | Video Bandwidth                                  | HP 856xE/<br>HP 8566B/<br>HP 8568B/<br>HP 8594E | available     |
| VBR <sup>1)</sup>                                            | VBR <numeric_value><br>VBR DN<br>VBR UP<br>VBR?                          | Video Bandwidth Ratio                            | HP 856xE/<br>HP 8566B/<br>HP 8568B/<br>HP 8594E | available     |
| VIEW                                                         | VIEW TRA TRB TRC                                                         |                                                  | HP 856xE/<br>HP 8566B/<br>HP 8568B/<br>HP 8594E | available     |
| VTL                                                          | VTL <numeric_value><br>DB DM<br>VTL DN<br>VTL UP<br>VTL?                 | Video Trigger Level                              | HP 856xE/<br>HP 8594E                           | not available |
| 1) HP 8594E only                                             |                                                                          |                                                  |                                                 |               |
| 2) Command is accepted without error message, but is ignored |                                                                          |                                                  |                                                 |               |

### 9.11.2.2 Special Features of the Syntax Parsing Algorithms for 8566A and 8568A Models

The command syntax is very different for models A and B. Different names are assigned to identical instrument functions, and the command structure likewise differs considerably between models A and models B.

The command structure for models A is as follows:

```
<command> ::= <command
code> [<SPC>] [<data>|<step>] [<SPC>] [<delimiter>] [<command
code>]...<delimiter>
```

```
<data> ::= <Value> [<SPC>] [<units
code>] [<SPC>] [<delimiter>] [<SPC>] [<data>]...
```

<step> ::= UP | DN

where

<command code> = see Table "Supported Commands"

<Value> = integer or floating-point numerical value

<units code> = DM | -DM | DB | HZ | KZ | MZ | GZ | MV | UV | SC | MS | US

<delimiter> = <CR> | <LF> | <,> | <;> | <ETX>

<SPC> = 32<sub>10</sub>

<ETX> = 3<sub>10</sub>

Command sections given in [ ] are optional.

The R&S FPL1000 GPIB hardware differs from that used in the HP analyzers. Therefore, the following constraint exists:

<LF> | <EOI> are still used as delimiters since the GPIB hardware is able to identify them. The other delimiters are identified and evaluated during syntax analysis.

### 9.11.2.3 Special Behavior of Commands

| Command | Known Differences                                                                                                                                                                       |
|---------|-----------------------------------------------------------------------------------------------------------------------------------------------------------------------------------------|
| ABORT   | Does not automatically set the command complete bit (bit 4) in the status byte. An additional DONE is required for that purpose.                                                        |
| ANNOT   | Only frequency axis annotation is affected.                                                                                                                                             |
| AT      | AT DN/UP: Step size                                                                                                                                                                     |
| CAL     | The CAL commands do not automatically set the command complete bit (bit 4) in the status byte. An additional DONE command is required for that purpose.                                 |
| CF      | Default value, range, step size                                                                                                                                                         |
| CR      | Default ratio Span/RBW                                                                                                                                                                  |
| CT      | Formula for coupled sweep time                                                                                                                                                          |
| CV      | Default ratio RBW/VBW                                                                                                                                                                   |
| DET     | DET? returns SAMP instead of SMP on the R&S FPL1000.<br>DET not automatically set the command complete bit (bit 4) in the status byte. An additional DONE is required for that purpose. |
| ERR?    | Deletes the error bit in the status register but always returns a '0' in response.                                                                                                      |
| FA      | Default value, range, step size                                                                                                                                                         |
| FB      | Default value, range, step size                                                                                                                                                         |
| ID      |                                                                                                                                                                                         |
| M2      | Default value, range, step size                                                                                                                                                         |
| M3      | Default value, range, step size                                                                                                                                                         |
| MKACT   | Only marker 1 is supported as the active marker.                                                                                                                                        |

| Command | Known Differences                                                                                                                                                                                                                                                      |
|---------|------------------------------------------------------------------------------------------------------------------------------------------------------------------------------------------------------------------------------------------------------------------------|
| MKBW    | Default value                                                                                                                                                                                                                                                          |
| MKPT    | Step size                                                                                                                                                                                                                                                              |
| MKPX    | Step size                                                                                                                                                                                                                                                              |
| OL?     | Storage of instrument settings:<br>80 characters are returned as information on the instrument settings.<br>The contents of the 80 characters returned does not correspond to the original data contents of the 8566A/8568A family.                                    |
| OL      | Readout of instrument settings:<br>The 80 characters read by means of OL? are accepted as information on the corresponding instrument settings.<br>The contents of the 80 characters read does not correspond to the original data contents of the 8566A/8568A family. |
| RB      | Default value, range, step size                                                                                                                                                                                                                                        |
| RL      | Default value, step size                                                                                                                                                                                                                                               |
| RLPOS   | Adapts the position of the reference level even if the tracking generator normalization is not active.                                                                                                                                                                 |
| RQS     | Supported bits:<br>1 (Units key pressed)<br>2 (End of Sweep)<br>3 (Device error)<br>4 (Command complete)<br>5 (Illegal command)                                                                                                                                        |

#### 9.11.2.4 Model-Dependent Default Settings

If the GPIB language is switched over to an 85xx model, the GPIB address is automatically switched over to 18 provided that the default address of the R&S FPL1000 (20) is still set. If a different value is set, this value is maintained. Upon return to SCPI, this address remains unchanged.

The following table shows the default settings obtained after a change of the GPIB language and for the commands IP, KST and RESET:

| Model   | # of Trace Points | Start Freq. | Stop Freq. | Ref Level | Input Coupling |
|---------|-------------------|-------------|------------|-----------|----------------|
| 8566A/B | 1001              | 2 GHz       | 22 GHz     | 0 dBm     | AC             |
| 8568A/B | 1001              | 0 Hz        | 1.5 GHz    | 0 dBm     | AC             |
| 8560E   | 601               | 0 Hz        | 2.9 GHz    | 0 dBm     | AC             |
| 8561E   | 601               | 0 Hz        | 6.5 GHz    | 0 dBm     | AC             |
| 8562E   | 601               | 0 Hz        | 13.2 GHz   | 0 dBm     | AC             |
| 8563E   | 601               | 0 Hz        | 26.5 GHz   | 0 dBm     | AC             |

| Model | # of Trace Points | Start Freq. | Stop Freq. | Ref Level | Input Coupling |
|-------|-------------------|-------------|------------|-----------|----------------|
| 8564E | 601               | 0 Hz        | 40 GHz     | 0 dBm     | AC             |
| 8565E | 601               | 0 Hz        | 50 GHz     | 0 dBm     | AC             |
| 8594E | 401               | 0 Hz        | 3 GHz      | 0 dBm     | AC             |



### Stop frequency

The stop frequency given in the table may be limited to the corresponding frequency range of the R&S FPL1000.

Command LF sets the stop frequency for 8566A/B to a maximum value of 2 GHz.

### Test points (trace points)

The number of trace points is switched over only upon transition to the REMOTE state.

#### 9.11.2.5 Data Output Formats

In the case of the SCPI and IEEE488.2 standards, the output formats for numerical data are flexible to a large extent. The output format for the HP units, by contrast, is accurately defined with respect to the number of digits. The memory areas for reading instrument data have therefore been adapted accordingly in the remote-control programs for instruments of this series.

Therefore, in response to a query, the R&S FPL1000 returns data of the same structure as that used by the original instruments; this applies in particular to the number of characters returned.

Two formats are currently supported when trace data is output: Display Units (command O1) and physical values (command O2, O3 or TDF P). As to the "Display Units" format, the level data of the R&S FPL1000 is converted to match the value range and the resolution of the 8566/8568 series. Upon transition to the **REMOTE** state, the R&S FPL1000 is reconfigured such that the number of test points (trace points) corresponds to that of the 85xx families (1001 for 8566A/B and 8568A/B, 601 for 8560E to 8565E, 401 for 8594E).

#### 9.11.2.6 Trace Data Output Formats

All formats are supported for trace data output: display units (command O1), display units in two byte binary data (command O2 or TDF B and MDS W), display units in one byte binary data (command O4 or TDF B and MDS B) and physical values (commands O3 or TDF P). With format "display units" the level data is converted into value range and resolution of the 8566/8568 models. On transition to REMOTE state the number of trace points are reconfigured in order to be conform to the selected instrument model (1001 for 8566A/B and 8568 A/B, 601 for 8560E to 8565E, 401 for 8594E).

### 9.11.2.7 Trace Data Input Formats

Trace data input is only supported for binary date (TDF B, TDF A, TDF I, MDS W, MDS B).

### 9.11.2.8 GPIB Status Reporting

The assignment of status bits by commands R1, R2, R3, R4, RQS is supported.

The STB command and the serial poll respond with an 8-bit value with the following assignment:

| Bit enabled by RQS | Description        |
|--------------------|--------------------|
| 0                  | not used (value 0) |
| 1                  | Units key pressed  |
| 2                  | End of Sweep       |
| 3                  | Device Error       |
| 4                  | Command Complete   |
| 5                  | Illegal Command    |
| 6                  | Service Request    |
| 7                  | not used (value 0) |

Bits 0 and 7 are not used and always have the value 0.

Please note that the R&S FPL1000 reports any key pressed on the front panel rather than only the unit keys if bit 1 was enabled.

Another difference is the behavior of bit 6 when using the STB? query. On the HP analyzers this bit monitors the state of the SRQ line on the bus. On the R&S FPL1000 this is not possible. Therefore this bit is set, as soon as one of the bits 1 to 5 is set. It won't be reset by performing a serial poll.

## 9.11.3 Reference: Command Set of Emulated CXA/EXA Models

The R&S FPL1000 analyzer family supports a subset of the GPIB commands of CXA/EXA instruments.

Despite the differences in system architecture and device features, the supported commands have been implemented in a way to ensure a sufficiently high degree of correspondence with the original.

In many cases the selection of commands supported by the R&S FPL1000 is sufficient to run an existing GPIB program without adaptation.

**Table 9-9: Supported CXA/EXA commands**

|                       |
|-----------------------|
| ABORt                 |
| CALCulate:MARKer:AOff |



## Emulating Other Instruments' Commands

|                                                                 |
|-----------------------------------------------------------------|
| CALCulate:MARKer[1] 2 ...12:MAXimum                             |
| CALCulate:MARKer[1] 2 ...12:MAXimum:LEFT                        |
| CALCulate:MARKer[1] 2 ...12:MAXimum:NEXT                        |
| CALCulate:MARKer[1] 2 ...12:MAXimum:RIGHT                       |
| CALCulate:MARKer[1] 2 ...12:MINimum                             |
| CALCulate:MARKer[1] 2 ...12:MODE POSition   DELTa   FIXed   OFF |
| CALCulate:MARKer[1] 2 ...12:MODE[?] SPAN   BAND                 |
| CALCulate:MARKer[1] 2 ...12[:SET]:CENTer                        |
| CALCulate:MARKer[1] 2 ...12[:SET]:RLEVel                        |
| CALCulate:MARKer[1] 2 ...12[:SET]:START                         |
| CALCulate:MARKer[1] 2 ...12[:SET]:STOP                          |
| CALCulate:MARKer[1] 2 ...12:STATe[?] OFF   ON   0   1           |
| CALCulate:MARKer[1] 2 ...12:X[?] <freq   time>                  |
| CALCulate:MARKer[1] 2 ...12:X:POSition[?] <real>                |
| CALCulate:MARKer[1] 2 ...4:X:SPAN                               |
| CALCulate:MARKer[1] 2 ...4:X:START                              |
| CALCulate:MARKer[1] 2 ...4:X:STOP                               |
| CALCulate:MARKer[1] 2 ...12:Y[?] <real>                         |
| CALibration[:ALL][?]                                            |
| CALibration:AUTO[?] ON   PARTial   OFF   ALERt                  |
| CALibration:AUTO:ALERt[?] TTEMPerature   DAY   WEEK   NONE      |
| CALibration:AUTO:MODE[?] ALL   NRF                              |
| CALibration:AUTO:TIME:OFF?                                      |
| CONFigure? SAN                                                  |
| DISPlay:WINDow[1]:TRACe:Y[:SCALe]:RLEVel[?] <real>              |
| DISPlay:WINDow[1]:TRACe:Y[:SCALe]:RLEVel:OFFSet[?] <rel_ampl>   |
| INITiate:CONtinuous[?] OFF   ON   0   1                         |
| INITiate[:IMMediate]                                            |
| INPut:COUPling[?] AC   DC                                       |
| MMEMory:CATalog? [<directory_name>]                             |
| MMEMory:CDIRectory[?] [<directory_name>]                        |
| MMEMory:COpy <string>, <string>[, <string>, <string>]           |
| MMEMory:DATA[?] <file_name>, <data>                             |
| MMEMory:DELeTe <file_name>[, <directory_name>]                  |

## Emulating Other Instruments' Commands

|                                                                    |
|--------------------------------------------------------------------|
| MMEMory:LOAD:STATe 1, <filename>                                   |
| MMEMory:MDIRectory <directory_name>                                |
| MMEMory:MOVE <string>, <string>[, <string>, <string>]              |
| MMEMory:RDIRectory <directory_name>                                |
| MMEMory:STORe:STATe 1, <filename>                                  |
| [[:SENSe]:AVERAge:COUNT[?] <integer>                               |
| [[:SENSe]:AVERAge[:STATe][?] ON   OFF   1   0                      |
| [[:SENSe]:AVERAge:TYPE[?] RMS   LOG   SCALAr[:SENSe]:AVERAge:TYPE? |
| [[:SENSe]:BANDwidth BWIDth[:RESolution][?] <freq>                  |
| [[:SENSe]:BANDwidth BWIDth[:RESolution]:AUTO[?] OFF   ON   0   1   |
| [[:SENSe]:BANDwidth BWIDth:VIDeo[?] <freq>                         |
| [[:SENSe]:BANDwidth BWIDth:VIDeo:AUTO[?] OFF   ON   0   1          |
| [[:SENSe]:BANDwidth BWIDth:VIDeo:RATio[?] <real>                   |
| [[:SENSe]:BANDwidth BWIDth:VIDeo:RATio:AUTO[?] OFF   ON   0   1    |
| [[:SENSe]:DETEctor:AUTO[?] ON   OFF   1   0                        |
| [[:SENSe]:FREQuency:CENTer[?] <freq>                               |
| [[:SENSe]:FREQuency:CENTer:STEP:AUTO[?] OFF   ON   0   1           |
| [[:SENSe]:FREQuency:OFFSet[?] <freq>                               |
| [[:SENSe]:FREQuency:SPAN[?] <freq>                                 |
| [[:SENSe]:FREQuency:SPAN:FULL                                      |
| [[:SENSe]:FREQuency:STARt[?] <freq>                                |
| [[:SENSe]:FREQuency:STOP[?] <freq>                                 |
| [[:SENSe]:POWEr[:RF]:ATTenuation[?] <rel_ampl>                     |
| [[:SENSe]:POWEr[:RF]:ATTenuation:AUTO[?] OFF   ON   0   1          |
| [[:SENSe]:SWEep:POINts? <integer>                                  |
| [[:SENSe]:SWEep:TIME? <time>                                       |
| [[:SENSe]:SWEep:TIME:AUTO? OFF   ON   0   1                        |
| TRIGger[:SEQUence]:EXTernal2:DELay[?] <time>                       |
| TRIGger[:SEQUence]:EXTernal1:DELay[?] <time>                       |
| TRIGger[:SEQUence]:EXTernal2:DELay:STATe[?] OFF   ON   0   1       |
| TRIGger[:SEQUence]:EXTernal1:DELay:STATe[?] OFF   ON   0   1       |
| TRIGger[:SEQUence]:EXTernal2:LEVel[?] <level>                      |
| TRIGger[:SEQUence]:EXTernal1:LEVel[?] <level>                      |
| TRIGger[:SEQUence]:EXTernal2:SLOPe[?] POSitive   NEGative          |

|                                                                                                                       |
|-----------------------------------------------------------------------------------------------------------------------|
| TRIGger[:SEQuence]:EXTErnal1:SLOPe[?] POSitive   NEGative                                                             |
| TRIGger[:SEQuence]:IF:LEVel[?]                                                                                        |
| TRIGger[:SEQuence]:IF:SLOPe[?] NEGative   POSitive                                                                    |
| TRIGger[:SEQuence]:SOURCe EXTErnal   IMMEDIATE   VIDEo   LINE   EXTErnal1   EXT1   EXTErnal2   EXT2   RFBurst   FRAME |
| TRIGger[:SEQuence]:VIDEo:DELay[?] <time>                                                                              |
| TRIGger[:SEQuence]:VIDEo:DELay:STATe[?] OFF   ON   0   1                                                              |
| TRIGger[:SEQuence]:VIDEo:LEVel[?] <ampl>                                                                              |
| TRIGger[:SEQuence]:VIDEo:SLOPe[?] POSitive   NEGative                                                                 |

## 9.12 Using the Status Register

For more information on the contents of the status registers see:

- "STATus:OPERation Register" on page 193
- "STATus:QUESTionable:ACPLimit Register" on page 195
- "STATus:QUESTionable:EXTended Register" on page 196
- "STATus:QUESTionable:FREQuency Register" on page 197
- "STATus:QUESTionable:LIMit Register" on page 197
- "STATus:QUESTionable:LMARgin Register" on page 198
- "STATus:QUESTionable:POWEr Register" on page 199
- "STATus:QUESTionable:TEMPerature Register" on page 199
- "STATus:QUESTionable:TIME Register" on page 200

|                                                 |     |
|-------------------------------------------------|-----|
| • General Status Register Commands.....         | 947 |
| • Reading Out the CONDition Part.....           | 948 |
| • Reading Out the EVENt Part.....               | 949 |
| • Controlling the ENABLe Part.....              | 949 |
| • Controlling the Negative Transition Part..... | 950 |
| • Controlling the Positive Transition Part..... | 950 |
| • Service Request.....                          | 951 |

### 9.12.1 General Status Register Commands

|                           |     |
|---------------------------|-----|
| STATus:PRESet.....        | 948 |
| STATus:QUEue[:NEXT]?..... | 948 |

**STATus:PRESet**

This command resets the edge detectors and `ENABLE` parts of all registers to a defined value. All `PTRansition` parts are set to `FFFFh`, i.e. all transitions from 0 to 1 are detected. All `NTRansition` parts are set to 0, i.e. a transition from 1 to 0 in a `CONDition` bit is not detected. The `ENABLE` part of the `STATus:OPERation` and `STATus:QUEStionable` registers are set to 0, i.e. all events in these registers are not passed on.

**Usage:** Event

**STATus:QUEue[:NEXT]?**

This command queries the most recent error queue entry and deletes it.

Positive error numbers indicate device-specific errors, negative error numbers are error messages defined by SCPI. If the error queue is empty, the error number 0, "No error", is returned.

This command is identical to the `SYSTem:ERRor[:NEXT]?` command.

**Usage:** Query only

## 9.12.2 Reading Out the CONDition Part

For more information on the condition part see "[Structure of a SCPI Status Register](#)" on page 189.

**STATus:OPERation:CONDition?****STATus:QUEStionable:CONDition?****STATus:QUEStionable:ACPLimit:CONDition?** <ChannelName>**STATus:QUEStionable:EXTended:CONDition?** <ChannelName>**STATus:QUEStionable:EXTended:INFO:CONDition?** <ChannelName>**STATus:QUEStionable:FREQuency:CONDition?** <ChannelName>**STATus:QUEStionable:LIMit<n>:CONDition?** <ChannelName>**STATus:QUEStionable:LMARgin<n>:CONDition?** <ChannelName>**STATus:QUEStionable:POWer:CONDition?** <ChannelName>**STATus:QUEStionable:TEMPerature:CONDition?** <ChannelName>**STATus:QUEStionable:TIME:CONDition?** <ChannelName>

These commands read out the `CONDition` section of the status register.

The commands do not delete the contents of the `CONDition` section.

**Suffix:**

<n> [Window](#)

**Query parameters:**

<ChannelName> String containing the name of the channel.  
The parameter is optional. If you omit it, the command works for the currently active channel.

**Usage:** Query only

### 9.12.3 Reading Out the EVENT Part

For more information on the event part see "[Structure of a SCPI Status Register](#)" on page 189.

---

```

STATus:OPERation[:EVENT]?
STATus:QUESTionable[:EVENT]?
STATus:QUESTionable:ACPLimit[:EVENT]? <ChannelName>
STATus:QUESTionable:EXTended[:EVENT]? <ChannelName>
STATus:QUESTionable:EXTended:INFO[:EVENT]? <ChannelName>
STATus:QUESTionable:FREQUENCY[:EVENT]? <ChannelName>
STATus:QUESTionable:LIMit<n>[:EVENT]? <ChannelName>
STATus:QUESTionable:LMARgin<n>[:EVENT]? <ChannelName>
STATus:QUESTionable:POWer[:EVENT]? <ChannelName>
STATus:QUESTionable:TEMPerature[:EVENT]? <ChannelName>
STATus:QUESTionable:TIME[:EVENT]? <ChannelName>

```

These commands read out the EVENT section of the status register.

At the same time, the commands delete the contents of the EVENT section.

**Suffix:**

<n> [Window](#)

**Query parameters:**

<ChannelName> String containing the name of the channel.  
The parameter is optional. If you omit it, the command works for the currently active channel.

**Usage:** Query only

### 9.12.4 Controlling the ENABLE Part

For more information on the enable part see "[Structure of a SCPI Status Register](#)" on page 189.

---

```

STATus:OPERation:ENABLE <SumBit>
STATus:QUESTionable:ENABLE <SumBit>
STATus:QUESTionable:ACPLimit:ENABLE <SumBit>,<ChannelName>
STATus:QUESTionable:EXTended:ENABLE <SumBit>,<ChannelName>
STATus:QUESTionable:EXTended:INFO:ENABLE <SumBit>,<ChannelName>
STATus:QUESTionable:FREQUENCY:ENABLE <SumBit>,<ChannelName>
STATus:QUESTionable:LIMit<n>:ENABLE <SumBit>,<ChannelName>
STATus:QUESTionable:LMARgin<n>:ENABLE <SumBit>,<ChannelName>
STATus:QUESTionable:POWer:ENABLE <SumBit>,<ChannelName>
STATus:QUESTionable:TEMPerature:ENABLE <SumBit>,<ChannelName>
STATus:QUESTionable:TIME:ENABLE <SumBit>,<ChannelName>

```

These commands control the ENABLE part of a register.

The ENABLE part allows true conditions in the EVENT part of the status register to be reported in the summary bit. If a bit is 1 in the enable register and its associated event bit transitions to true, a positive transition will occur in the summary bit reported to the next higher level.

**Suffix:**

<n> [Window](#)

**Parameters:**

<SumBit> Range: 0 to 65535

<ChannelName> String containing the name of the channel.  
The parameter is optional. If you omit it, the command works for the currently active channel.

### 9.12.5 Controlling the Negative Transition Part

For more information on the positive transition part see "[Structure of a SCPI Status Register](#)" on page 189.

---

**STATus:OPERation:NTRansition** <SumBit>  
**STATus:QUESTIONable:NTRansition** <SumBit>  
**STATus:QUESTIONable:ACPLimit:NTRansition** <SumBit>,<ChannelName>  
**STATus:QUESTIONable:EXTended:NTRansition** <SumBit>,<ChannelName>  
**STATus:QUESTIONable:EXTended:INFO:NTRansition** <SumBit>,<ChannelName>  
**STATus:QUESTIONable:FREQUENCY:NTRansition** <SumBit>,<ChannelName>  
**STATus:QUESTIONable:LIMit<n>:NTRansition** <SumBit>,<ChannelName>  
**STATus:QUESTIONable:LMARgin<n>:NTRansition** <SumBit>,<ChannelName>  
**STATus:QUESTIONable:POWER:NTRansition** <SumBit>,<ChannelName>  
**STATus:QUESTIONable:TEMPerature:NTRansition** <SumBit>,<ChannelName>  
**STATus:QUESTIONable:TIME:NTRansition** <SumBit>,<ChannelName>

These commands control the Negative Transition part of a register.

Setting a bit causes a 1 to 0 transition in the corresponding bit of the associated register. The transition also writes a 1 into the associated bit of the corresponding EVENT register.

**Suffix:**

<n> [Window](#)

**Parameters:**

<SumBit> Range: 0 to 65535

<ChannelName> String containing the name of the channel.  
The parameter is optional. If you omit it, the command works for the currently active channel.

### 9.12.6 Controlling the Positive Transition Part

For more information on the negative transition part see "[Structure of a SCPI Status Register](#)" on page 189.

**STATus:OPERation:PTRansition** <SumBit>  
**STATus:QUESTionable:PTRansition** <SumBit>  
**STATus:QUESTionable:ACPLimit:PTRansition** <SumBit>,<ChannelName>  
**STATus:QUESTionable:EXTended:PTRansition** <SumBit>,<ChannelName>  
**STATus:QUESTionable:EXTended:INFO:PTRansition** <SumBit>,<ChannelName>  
**STATus:QUESTionable:FREQuency:PTRansition** <SumBit>,<ChannelName>  
**STATus:QUESTionable:LIMit<n>:PTRansition** <SumBit>,<ChannelName>  
**STATus:QUESTionable:LMARgin<n>:PTRansition** <SumBit>,<ChannelName>  
**STATus:QUESTionable:POWer:PTRansition** <SumBit>,<ChannelName>  
**STATus:QUESTionable:TEMPerature:PTRansition** <SumBit>,<ChannelName>  
**STATus:QUESTionable:TIME:PTRansition** <SumBit>,<ChannelName>

These commands control the Positive TRansition part of a register.

Setting a bit causes a 0 to 1 transition in the corresponding bit of the associated register. The transition also writes a 1 into the associated bit of the corresponding EVENT register.

**Suffix:**

<n> [Window](#)

**Parameters:**

<SumBit> Range: 0 to 65535

<ChannelName> String containing the name of the channel.  
The parameter is optional. If you omit it, the command works for the currently active channel.

## 9.12.7 Service Request

The service request routine requires an extended initialization of the instrument in which the relevant bits of the transition and enable registers are set. In addition the service request event must be enabled in the VISA session.

### 9.12.7.1 Initiate Service Request

```

REM ---- Example of initialization of the SRQ in the case
' of errors -----
PUBLIC SUB SetupSRQ()
CALL InstrWrite (analyzer, "*CLS") 'Reset status reporting system
CALL InstrWrite (analyzer, "*SRE 168") 'Enable service request for
'STAT:OPER, STAT:QUES and ESR
'register
CALL InstrWrite (analyzer, "*ESE 60") 'Set event enable bit for
'command, execution, device-
'dependent and query error
CALL InstrWrite (analyzer, "STAT:OPER:ENAB 32767")
'Set OPERation enable bit for
'all events
CALL InstrWrite (analyzer, "STAT:OPER:PTR 32767")
'Set appropriate OPERation

```

```

'Ptransition bits
CALL InstrWrite (analyzer, "STAT:QUES:ENAB 32767")
'Set questionable enable bits
'for all events
CALL InstrWrite (analyzer, "STAT:QUES:PTR 32767")
'Set appropriate questionable
'Ptransition bits
CALL viEnableEvent(analyzer, VI_EVENT_SERVICE_REQ, VI_QUEUE, 0)
'Enable the event for service
'request
Status = viWaitOnEvent(analyzer, VI_EVENT_SERVICE_REQ, SRQWaitTimeout, VI_NULL,
 VI_NULL)
IF (status = VI_SUCCESS) THEN CALL Srq
'If SRQ is recognized =>
'subroutine for evaluation
END SUB
REM *****

Private mbSession As MessageBasedSession

Sub Main()
 Console.WriteLine("Example of initialization _
 of the SRQ in the case of errors.")
 Dim SRQWaitTimeout = 4000 ' Timeout As Integer for WaitOnEvent
 'Opening session
 Try
 'FSW is alias, instead of use resource string.
 'For example on TCP use TCP/IP0::192.168.1.2::inst0::INSTR
 mbSession = CType(ResourceManager.GetLocalManager().Open("FSW"), _
 MessageBasedSession)
 mbSession.TerminationCharacterEnabled = True
 Try
 mbSession.Write("*CLS") 'Reset status reporting system
 mbSession.Write("*SRE 168") 'Enable service request for
 'STAT:OPER, STAT:QUES and ESR register
 mbSession.Write("*ESE 60") 'Set event enable bit for
 'command, execution, device-dependent and query error
 mbSession.Write("STAT:OPER:ENAB 32767")
 'Set OPERATION enable bit for all events
 mbSession.Write("STAT:OPER:PTR 32767")
 'Set appropriate OPERATION Ptransition bits
 mbSession.Write("STAT:QUES:ENAB 32767")
 'Set questionable enable bits for all events
 mbSession.Write("STAT:QUES:PTR 32767")
 'Set appropriate questionable Ptransition bits
 Console.WriteLine("Wait on event - Blocking")
 mbSession.EnableEvent(MessageBasedSessionEventType.ServiceRequest, _
 EventMechanism.Queue)
 'Enable the event for service request

```



```

'-----
' Your command please use here
' mbSession.Write("Your command")
'-----

Dim Status = mbSession.WaitOnEvent(_
 MessageBasedSessionEventType.ServiceRequest, SRQWaitTimeout)
If (Status.EventType() = _
 MessageBasedSessionEventType.ServiceRequest) Then
 Console.WriteLine("SRQ is recognized")
 'If SRQ is recognized => subroutine for evaluation
 Srq()
End If
Catch exp As Exception
 Console.WriteLine(exp.Message)
End Try
Catch exp As InvalidCastException
 Console.WriteLine("Resource selected must be a message-based session")
Catch exp As Exception
 Console.WriteLine(exp.Message)
End Try

' Close session
mbSession.Dispose()
' Wait for end
Console.WriteLine("Press any key to end")
Console.ReadKey()
End Sub

```

### 9.12.7.2 Waiting for the Arrival of a Service Request

There are basically two methods of waiting for the arrival of a service request:

#### **Blocking (user inputs not possible):**

This method is appropriate if the waiting time until the event to be signaled by an SRQ is short (shorter than the selected timeout), if no response to user inputs is required during the waiting time, and if – as the main criterion – the event is absolutely certain to occur.

Reason:

From the time the `viWaitOnEvent()` function is called until the occurrence of the expected event, it does not allow the program to respond to mouse clicks or key entries during the waiting time. Moreover, it returns an error if the SRQ event does not occur within the predefined timeout period.

The method is, therefore, in many cases not suitable for waiting for measurement results, especially when using triggered measurements.

The following function calls are required:

```

Status = viWaitOnEvent(analyzer, VI_EVENT_SERVICE_REQ, SRQWaitTimeout, VI_NULL,
 VI_NULL)
'Wait for service request user
'inputs are not possible during
'the waiting time!
IF (status = VI_SUCCESS) THEN CALL Srq
'If SRQ is recognized =>
'subroutine for evaluation

'----- Sweep in first Spectrum Tab and query marker -----
Dim Status = mbSession.WaitOnEvent(_
MessageBasedSessionEventType.ServiceRequest, SRQWaitTimeout)
'Wait for service request user inputs are not possible
'during the waiting time!
If (Status.EventType() = MessageBasedSessionEventType.ServiceRequest) Then
'If SRQ is recognized => subroutine for evaluation
 Srq()
End If

```

#### Non-blocking (user inputs possible):

This method is recommended if the waiting time until the event to be signaled by an SRQ is long (longer than the selected timeout), and user inputs should be possible during the waiting time, or if the event is not certain to occur. This method is, therefore, the preferable choice for waiting for the end of measurements, i.e. the output of results, especially in the case of triggered measurements.

The method necessitates a waiting loop that checks the status of the SRQ line at regular intervals and returns control to the operating system during the time the expected event has not yet occurred. In this way, the system can respond to user inputs (mouse clicks, key entries) during the waiting time.

It is advisable to employ the Hold() auxiliary function, which returns control to the operating system for a selectable waiting time (see section [Waiting Without Blocking the Keyboard and Mouse](#)), so enabling user inputs during the waiting time.

```

result% = 0
For i = 1 To 10 'Abort after max. 10 loop
'iterations
Status = viWaitOnEvent(analyzer, VI_EVENT_SERVICE_REQ, VI_TMO_IMMEDIATE, VI_NULL,
 VI_NULL)
'Check event queue
If (status = VI_SUCCESS) Then
result% = 1
CALL Srq 'If SRQ is recognized =>
'subroutine for evaluation
Else
CALL Hold(20) 'Call hold function with
'20 ms 'waiting time. User inputs
'are possible.
Endif

```

```

Next i
If result% = 0 Then
Debug.Print "Timeout Error; Program aborted" 'Output error message
STOP 'Stop software
Endif

```

### 9.12.7.3 Waiting Without Blocking the Keyboard and Mouse

A frequent problem with remote control programs using Visual Basic is to insert waiting times without blocking the keyboard and the mouse.

If the program is to respond to user inputs also during a waiting time, control over the program events during this time must be returned to the operating system. In Visual Basic, this is done by calling the `DoEvents` function. This function causes keyboard-or mouse-triggered events to be executed by the associated elements. For example, it allows the operation of buttons and input fields while the user waits for an instrument setting to be completed.

The following programming example describes the `Hold()` function, which returns control to the operating system for the period of the waiting time selectable in milliseconds.

```

Rem *****
Rem The waiting function below expects the transfer of the desired
Rem waiting time in milliseconds. The keyboard and the mouse remain
Rem operative during the waiting period, thus allowing desired elements
Rem to be controlled
Rem *****
Public Sub Hold(delayTime As Single)
Start = Timer 'Save timer count on calling the
'function
Do While Timer < Start + delayTime/1000 'Check timer count
DoEvents 'Return control to operating
'system to enable control of
'desired elements as long as
'timer has not elapsed
Loop
End Sub
Rem *****

```

The waiting procedure is activated simply by calling `Hold(<Waiting time in milliseconds>)`.

### 9.12.7.4 Service Request Routine

A service request is processed in the service request routine.



The variables `userN%` and `userM%` must be pre-assigned usefully!

```

REM ----- Service request routine -----
Public SUB Srq()
ON ERROR GOTO noDevice 'No user existing
CALL viReadSTB(analyzer, STB%) 'Serial poll, read status byte
IF STB% > 0 THEN 'This instrument has bits set in
'the STB
SRQFOUND% = 1
IF (STB% AND 16) > 0 THEN CALL Outputqueue
IF (STB% AND 4) > 0 THEN CALL ErrorQueueHandler
IF (STB% AND 8) > 0 THEN CALL Questionablestatus
IF (STB% AND 128) > 0 THEN CALL Operationstatus
IF (STB% AND 32) > 0 THEN CALL Esrread
END IF
noDevice:
END SUB 'End of SRQ routine
REM *****

REM ----- Subroutine for evaluation Service Request Routine -----

Public Sub Srq()
 Try
 Dim mySTB As Short = mbSession.ReadStatusByte()
 'Serial poll, read status byte
 Console.WriteLine("Reading Service Request Routine:" + mySTB.ToString())
 If mySTB > 0 Then 'This instrument has bits set in the STB
 If (mySTB And 16) > 0 Then Call Outputqueue()
 If (mySTB And 4) > 0 Then Call ErrorQueueHandler()
 If (mySTB And 8) > 0 Then Call Questionablestatus()
 If (mySTB And 128) > 0 Then Call Operationstatus()
 If (mySTB And 32) > 0 Then Call Esrread()
 End If
 Catch exp As Exception
 Console.WriteLine(exp.Message)
 End Try
End Sub 'End of SRQ routine

```

Reading out the status event registers, the output buffer and the error/event queue is effected in subroutines.

### 9.12.7.5 Reading Out the Output Buffer

```

REM ----- Subroutine for the individual STB bits -----
Public SUB Outputqueue() 'Reading the output buffer
result$ = SPACE$(100) 'Make space for response
CALL InstrRead(analyzer, result$)
Debug.Print "Contents of Output Queue:"; result$
END SUB
REM *****

REM ----- Subroutine for the output queue -----
Public Sub Outputqueue() 'Reading the output buffer

```

```

 Try
 Dim result As String = mbSession.ReadString()
 Console.WriteLine("Contents of Output Queue:" + result)
 Catch exp As Exception
 Console.WriteLine(exp.Message)
 End Try
End Sub

```

### 9.12.7.6 Reading Error Messages

```

REM ----- Subroutine for reading the error queue -----
Public SUB ErrorQueueHandler()
ERROR$ = SPACE$(100) 'Make space for error variable
CALL InstrWrite (analyzer, "SYSTEM:ERROR?")
CALL InstrRead(analyzer, ERROR$)
Debug.Print "Error Description: "; ERROR$
END SUB
REM *****

REM ----- Subroutine for reading the error queue -----
Sub ErrorQueueHandler()
 Dim result As String
 Dim hasErr As Boolean = True
 Do
 mbSession.Write("SYST:ERR?")
 result = mbSession.ReadString()
 Dim parts As String() = result.Split(",")
 If parts(0) = 0 Then
 hasErr = False
 Console.WriteLine(result)
 Else
 Console.WriteLine(result)
 End If
 Loop While hasErr
End Sub

```

### 9.12.7.7 Evaluation of SCPI Status Registers

```

REM ----- Subroutine for evaluating Questionable Status Register -----
Public SUB Questionablestatus()
Ques$ = SPACE$(20)
'Preallocate blanks to text
'variable
CALL InstrWrite (analyzer, "STATus:QUESTionable:EVENT?")
CALL InstrRead(analyzer, Ques$)
Debug.Print "Questionable Status: "; Ques$
END SUB
REM *****

REM ----- Subroutine for evaluating Operation Status Register -----

```

```

Public SUB Operationstatus()
Oper$ = SPACE$(20) 'Preallocate blanks to text
'variable
CALL InstrWrite (analyzer, "STaTus:OPERation:EVENT?")
CALL InstrRead(analyzer, Oper$)
Debug.Print "Operation Status: "; Oper$
END SUB
REM *****

REM ----- Subroutine for evaluating Questionable Status Register -----
Public Sub Questionablestatus()
 Dim myQSR As String = Nothing
 Try
 myQSR = mbSession.Query("STaTus:QUEStionable:EVENT?") 'Read QSR
 Console.WriteLine("Questionable Status:" + myQSR)
 Catch exp As Exception
 Console.WriteLine(exp.Message)
 End Try
End Sub

REM ----- Subroutine for evaluating Operation Status Register -----
Public Sub Operationstatus()
 Dim myOSR As String = Nothing
 Try
 myOSR = mbSession.Query("STaTus:OPERation:EVENT?") 'Read OSR
 Console.WriteLine("Operation Status:" + myOSR)
 Catch exp As Exception
 Console.WriteLine(exp.Message)
 End Try
End Sub

```

### 9.12.7.8 Evaluation of Event Status Register

```

REM ----- Subroutine for evaluating the Event Status Register -----
Public SUB Esrread()
Esr$ = SPACE$(20) 'Preallocate blanks to text
'variable
CALL InstrWrite (analyzer, "*ESR?") 'Read ESR
CALL InstrRead(analyzer, Esr$)
IF (VAL(Esr$) AND 1) > 0 THEN Debug.Print "Operation complete"
IF (VAL(Esr$) AND 2) > 0 THEN Debug.Print "Request Control"
IF (VAL(Esr$) AND 4) > 0
THEN Debug.Print "Query Error"
IF (VAL(Esr$) AND 8) > 0
THEN Debug.Print "Device dependent error"
IF (VAL(Esr$) AND 16) > 0
THEN Debug.Print "Execution Error; Program aborted" 'Output error message
STOP 'Stop software
END IF
IF (VAL(Esr$) AND 32) > 0

```

```

THEN Debug.Print "Command Error; Program aborted" 'Output error message
STOP 'Stop software
END IF
IF (VAL(Esr$) AND 64) > 0 THEN Debug.Print "User request"
IF (VAL(Esr$) AND 128) > 0 THEN Debug.Print "Power on"END SUB
REM *****
REM ----- Subroutine for evaluating the Event Status Register -----
Public Sub Esrread()
 Try
 Dim myESR As Short = mbSession.Query("*ESR?") 'Read ESR
 If (myESR And 1) > 0 Then Console.WriteLine("Operation complete")
 If (myESR And 2) > 0 Then Console.WriteLine("Request Control")
 If (myESR And 4) > 0 Then Console.WriteLine("Query Error")
 If (myESR And 8) > 0 Then Console.WriteLine("Device dependent error")
 If (myESR And 16) > 0 Then
 Console.WriteLine("Execution Error; Program aborted") 'Output error message
 Stop 'Stop software
 End If
 If (myESR And 32) > 0 Then
 Console.WriteLine("Command Error; Program aborted") 'Output error message
 Stop 'Stop software
 End If
 If (myESR And 64) > 0 Then Console.WriteLine("User request")
 If (myESR And 128) > 0 Then Console.WriteLine("Power on")
 Catch exp As Exception
 Console.WriteLine(exp.Message)
 End Try
End Sub

```

## 9.13 Deprecated Commands

The following commands are provided for compatibility to other signal analyzers only. For new remote control programs use the specified alternative commands.

|                                                                         |     |
|-------------------------------------------------------------------------|-----|
| <a href="#">CALCulate&lt;n&gt;:LIMit&lt;li&gt;:TRACe&lt;t&gt;</a> ..... | 959 |
| <a href="#">DISPlay[:WINDow&lt;n&gt;]:STATe</a> .....                   | 960 |
| <a href="#">DISPlay[:WINDow&lt;n&gt;]:TYPE</a> .....                    | 960 |
| <a href="#">HCOPY:ITEM:ALL</a> .....                                    | 960 |

---

### **CALCulate<n>:LIMit<li>:TRACe<t>** <TraceNumber>

This command links a limit line to one or more traces.

Note that this command is maintained for compatibility reasons only. Limit lines no longer need to be assigned to a trace explicitly. The trace to be checked can be defined directly (as a suffix) in the new command to activate the limit check (see [CALCulate<n>:LIMit<li>:TRACe<t>:CHECK](#) on page 857).

**Suffix:**

|      |            |
|------|------------|
| <n>  | Window     |
| <li> | Limit line |
| <t>  | irrelevant |

**Parameters:**

|               |        |
|---------------|--------|
| <TraceNumber> | 1 to 6 |
| *RST:         | 1      |

**Example:**

CALC:LIM2:TRAC 3  
Assigns limit line 2 to trace 3.

**DISPlay[:WINDow<n>]:STATe <State>**

This command changes the display state of the selected measurement window.

Note that this command is maintained for compatibility reasons only. Use the LAYout commands for new remote control programs

(See [Chapter 9.7.1, "Working with Windows in the Display"](#), on page 703).

**Suffix:**

|     |        |
|-----|--------|
| <n> | Window |
|-----|--------|

**Parameters:**

|         |                                             |
|---------|---------------------------------------------|
| <State> | ON   OFF   0   1                            |
|         | <b>OFF   0</b><br>Switches the function off |
|         | <b>ON   1</b><br>Switches the function on   |

**DISPlay[:WINDow<n>]:TYPE <WindowType>**

This command selects the results displayed in a measurement window.

Note that this command is maintained for compatibility reasons only. Use the LAYout commands for new remote control programs (see [Chapter 9.7.1, "Working with Windows in the Display"](#), on page 703).

The parameter values are the same as for [LAYout:ADD\[:WINDow\]?](#) on page 703.

**Suffix:**

|     |        |
|-----|--------|
| <n> | Window |
|-----|--------|

**Parameters:**

|              |                                                |
|--------------|------------------------------------------------|
| <WindowType> | DIAGram   RSUMmary   MTABLE   PEAKlist   SGRam |
|--------------|------------------------------------------------|

**HCOPy:ITEM:ALL**

This command is maintained for compatibility reasons only. It has no effect.



## 10 Maintenance

The R&S FPL1000 does not require regular maintenance. Maintenance is essentially restricted to cleaning the R&S FPL1000. It is, however, recommended that you check the nominal data from time to time.

The data sheet specifies the storage temperature range for the R&S FPL1000. Protect the instrument against dust if it is to be stored for a long period.

### 10.1 Cleaning

---

**⚠ WARNING****Risk of electric shock**

If moisture enters the casing, for example if you clean the instrument using a moist cloth, contact with the instrument can lead to electric shock. Before cleaning the instrument other than with a dry cloth, make sure that the instrument is switched off and disconnected from all power supplies.

---

**NOTICE****Instrument damage caused by cleaning agents**

Cleaning agents contain substances such as solvents (thinners, acetone, etc.), acids, bases, or other substances. Solvents can damage the front panel labeling, plastic parts, or screens, for example.

Never use cleaning agents to clean the outside of the instrument. Use a soft, dry, lint-free dust cloth instead.

---

**NOTICE****Risk of instrument damage due to obstructed fans**

If the instrument is operated in dusty areas, the fans become obstructed by dust or other particles over time. Check and clean the fans regularly to ensure that they always operate properly. If the instrument is run with obstructed fans for a longer period, the instrument overheats, which can disturb the operation and even cause damage.

---

1. Clean the outside of the instrument using a soft, dry, lint-free dust cloth.
2. Check and clean the fans regularly to ensure that they always operate properly.
3. Clean the touchscreen as follows:
  - a) Apply a small amount of standard screen cleaner to a soft cloth.
  - b) Wipe the screen gently with the moist, but not wet, cloth.

- c) If necessary, remove any excess moisture with a dry, soft cloth.

# 11 Troubleshooting

If the results do not meet your expectations, the following sections may contain helpful hints and information.

- [Error Information](#)..... 963
- [Error Messages in Remote Control Mode](#)..... 964
- [Troubleshooting Remote Operation](#)..... 965
- [Miscellaneous Troubleshooting Hints](#)..... 966
- [Collecting Information for Support](#)..... 968

## 11.1 Error Information

If errors or irregularities are detected, a keyword and an error message, if available, are displayed in the status bar.



Depending on the type of message, the status message is indicated in varying colors.

**Table 11-1: Status bar information - color coding**

| Color    | Type                   | Description                                                                                                                                                                       |
|----------|------------------------|-----------------------------------------------------------------------------------------------------------------------------------------------------------------------------------|
| Red      | Error                  | An error occurred at the start or during a measurement, e.g. due to missing data or wrong settings, so that the measurement cannot be started or completed correctly.             |
| Orange   | Warning                | An irregular situation occurred during measurement, e.g. the settings no longer match the displayed results, or the connection to an external device was interrupted temporarily. |
| Gray     | Information            | Information on the status of individual processing steps.                                                                                                                         |
| No color | No errors              | No message displayed - normal operation.                                                                                                                                          |
| Green    | Measurement successful | Some applications visualize that the measurement was successful by showing a message.                                                                                             |



If any error information is available for a channel setup, an exclamation mark is displayed next to the channel setup name (■). This is particularly useful when the MultiView tab is displayed, as the status bar in the MultiView tab always displays the information for the currently selected measurement only.

**Table 11-2: List of keywords**

|                   |                                                                                                                                                                                                                                                                   |
|-------------------|-------------------------------------------------------------------------------------------------------------------------------------------------------------------------------------------------------------------------------------------------------------------|
| <b>IF OVLD</b>    | Overload of the IF signal path in the A/D converter or in the digital IF. <ul style="list-style-type: none"> <li>• Increase the reference level.</li> </ul>                                                                                                       |
| <b>INPUT OVLD</b> | The signal level at the RF input connector exceeds the maximum.<br>The RF input is disconnected from the input mixer to protect the device. To re-enable measurement, decrease the level at the RF input connector and reconnect the RF input to the mixer input. |

|                 |                                                                                                                                                                                                                                                                                              |
|-----------------|----------------------------------------------------------------------------------------------------------------------------------------------------------------------------------------------------------------------------------------------------------------------------------------------|
| <b>LOUNL</b>    | Error in the instrument's frequency processing hardware was detected.                                                                                                                                                                                                                        |
| <b>NO REF</b>   | Instrument was set to an external reference but no signal was detected on the reference input.                                                                                                                                                                                               |
| <b>RF OVLD</b>  | Overload of the input mixer or of the analog IF path. <ul style="list-style-type: none"> <li>• Increase the RF attenuation (for RF input).</li> <li>• Reduce the input level (for digital input)</li> </ul>                                                                                  |
| <b>UNCAL</b>    | One of the following conditions applies: <ul style="list-style-type: none"> <li>• Correction data has been switched off.</li> <li>• No correction values are available, for example after a firmware update.</li> <li>• Record the correction data by performing a self alignment</li> </ul> |
| <b>WRONG_FW</b> | The firmware version is out-of-date and does not support the currently installed hardware. Until the firmware version is updated, this error message is displayed and self-alignment fails.                                                                                                  |

## 11.2 Error Messages in Remote Control Mode

In remote control mode error messages are entered in the error/event queue of the status reporting system and can be queried with the command `SYSTEM:ERROR?`. The answer format of R&S FPL1000 to the command is as follows:

```
<error code>, "<error text with queue query>; <remote control command concerned>"
```

The indication of the remote control command with prefixed semicolon is optional.

### Example:

The command `TEST:COMMAND` generates the following answer to the query

```
SYSTEM:ERROR?
```

```
-113, "Undefined header;TEST:COMMAND"
```

There are two types of error messages:

- Error messages defined by SCPI are marked by negative error codes. These messages are defined and described in the SCPI standard and not listed here.
- Device-specific error messages use positive error codes. These messages are described below.

**Table 11-3: Device-specific error messages**

| Error code | Error text in the case of queue poll<br>Error explanation                                                                                                                                         |
|------------|---------------------------------------------------------------------------------------------------------------------------------------------------------------------------------------------------|
| 1052       | <b>Frontend LO is Unlocked</b><br>This message is displayed when the phase regulation of the local oscillator fails in the RF front-end.                                                          |
| 1060       | <b>Trigger-Block Gate Delay Error- gate length &lt; Gate Delay</b><br>This message is displayed when the gate signal length is not sufficient for the pull-in delay with a predefined gate delay. |

| Error code | Error text in the case of queue poll<br>Error explanation                                                                                                                                                                                                                                                                                                                                                                                                       |
|------------|-----------------------------------------------------------------------------------------------------------------------------------------------------------------------------------------------------------------------------------------------------------------------------------------------------------------------------------------------------------------------------------------------------------------------------------------------------------------|
| 1064       | <b>Tracking LO is Unlocked</b><br>This message is displayed when the phase regulation of the local oscillator fails on the external generator module.                                                                                                                                                                                                                                                                                                           |
| 2028       | <b>Hardcopy not possible during measurement sequence</b><br>This message is displayed when a printout is started during scan sequences that cannot be interrupted. Such sequences are for example: <ul style="list-style-type: none"> <li>• Recording the system error correction data (alignment)</li> <li>• Instrument self-test</li> </ul> In such cases synchronization to the end of the scan sequence should be performed prior to starting the printout. |
| 2033       | <b>Printer Not Available</b><br>This message is displayed when the selected printer is not included in the list of available output devices. A possible cause is that the required printer driver is missing or incorrectly installed.                                                                                                                                                                                                                          |
| 2034       | <b>CPU Temperature is too high</b><br>This message is displayed when the temperature of the processor exceeds 70 °C.                                                                                                                                                                                                                                                                                                                                            |

## 11.3 Troubleshooting Remote Operation

If problems arise during measurement in remote operation, try the following methods to solve them.

### Incompleted sequential commands - blocked remote channels

If a sequential command cannot be completed, for example because a triggered sweep never receives a trigger, the remote control program will never finish and the remote channel to the R&S FPL1000 is blocked for further commands. In this case, you must interrupt processing on the remote channel in order to abort the measurement.

### To regain control over a blocked remote channel

Usually, if you wait a minute for the VISA connection to detect the lost connection and clear the control channel by itself, you can then re-establish the connection again. If this fails, try the following:

1. Press "Local" on the front panel of the R&S FPL1000 to return to manual operation (if not disabled). Then re-establish the connection.
2. Send a "Device Clear" command from the control instrument to the R&S FPL1000 to clear all currently active remote channels. Depending on the used interface and protocol, send the following commands:
  - **Visa:** `viClear()`

The remote channel currently processing the incompleted command is then ready to receive further commands again.

3. On the remote channel performing the measurement, send the SCPI command `ABORT` to abort the current measurement and reset the trigger system.
4. If the R&S FPL1000 still does not react to the remote commands, switch it off and back on.

### Ignored commands

When a remote command attempts to define incompatible settings, the command is ignored and the instrument status remains unchanged, i.e. other settings are not automatically adapted. Therefore, control programs should always define an initial instrument status (e.g. using the `*RST` command) and then implement the required settings.

### Detecting false commands

If a remote program does not provide the expected results and you are using a GPIB connection, you can log the commands and any errors that may occur. To activate the SCPI error log function, in the "Network + Remote" dialog box, in the "GPIB" tab, select "I/O Logging".

All remote control commands received by the R&S FPL1000 are recorded in the following log file:

```
C:\ProgramData\Rohde-Schwarz\ZNL-FPL\ScpiLogging\ScpiLog.txt
```

Logging the commands may be extremely useful for debug purposes, e.g. in order to find misspelled keywords in control programs. However, remember to turn off the logging function after debugging to avoid unnecessary access to the hard drive and use of storage space.

## 11.4 Miscellaneous Troubleshooting Hints

|                                                                                                                                         |     |
|-----------------------------------------------------------------------------------------------------------------------------------------|-----|
| Invalid trace display.....                                                                                                              | 966 |
| Data capturing takes too long.....                                                                                                      | 966 |
| Multiple user access to one instrument.....                                                                                             | 967 |
| Web browser access to instrument fails .....                                                                                            | 967 |
| The transducer factors/limit lines applied to my measurement are different to those displayed in the Transducer / Lines dialog box..... | 967 |

### Invalid trace display

If output to the [IF 2 GHz OUT] connector is activated, the measured values are no longer sent to the display; thus, the trace data currently displayed on the R&S FPL1000 becomes invalid. A message in the status bar indicates this situation.

### Data capturing takes too long

Particularly for FFT sweeps, the time required to process the data may be considerably longer than the time required to capture the data. Thus, if you only consider the defined sweep time, you may assume an error has occurred if the measurement takes longer than expected.

However, while the sweep time only defines the time in which data is actually captured, the total sweep *duration* includes the time required for capturing *and processing* the data. Thus, for FFT sweeps in the Spectrum application, the sweep duration is now also indicated in the channel bar, behind the sweep time. In remote operation, the estimated sweep duration can be queried for all sweep modes (also zero span and frequency sweeps).

**Tip:** To determine the necessary timeout for data capturing in a remote control program, double the estimated time and add 1 second.

Remote command:

[SENSe:]SWEep:DURation? on page 726

#### **Multiple user access to one instrument**

Using the R&S FPL1000's LXI browser interface, several users can access *and operate* the same instrument simultaneously. This is useful for troubleshooting or training purposes.

Type the instrument's host name or IP address in the address field of the browser on your PC, for example "http://10.113.10.203". The instrument home page (welcome page) opens.

**Note:** This function can be deactivated for the instrument. After a firmware update, it is automatically activated again.

#### **Web browser access to instrument fails**

If an error message ( "Failed to connect to server (code. 1006)" ) is displayed in the web browser instead of the instrument's user interface then the LXI web browser interface was probably deactivated.

(See [Chapter 7.4.4.6, "How to Deactivate the Web Browser Interface"](#), on page 228).

#### **The transducer factors/limit lines applied to my measurement are different to those displayed in the Transducer / Lines dialog box**

If a transducer file was in use when the save set was stored (with the save item "Current Settings" only) it is anticipated that these transducer values should remain valid after every recall of that save set. Thus, even if the transducer file is changed and the original save set file is recalled later, the *originally stored* transducer values are recalled and applied to the measurement. In the "Transducer" dialog box, however, the *changed* transducer file values are displayed as no updated transducer file was loaded.

The same applies to limit line settings.

If you want to apply the changed transducer values after recalling the save set you must force the application to reload the transducer file. To do so, simply open the "Edit Transducer" dialog box (see [Chapter 7.3.6.2, "Transducer Settings"](#), on page 154) and toggle the "X-Axis" option from "Lin" to "Log" and back. Due to that change, the transducer file is automatically reloaded, and the changed transducer values are applied to the current measurement. Now you can create a new save set with the updated transducer values.

Similarly, if you want to apply the changed limit values after recalling the save set you must force the application to reload the limit file. To do so, simply open the "Edit Limit Line" dialog box (see [Chapter 8.11.2.2, "Limit Line Settings and Functions"](#), on page 542) and toggle the "Y-Axis" unit. Due to that change, the limit line file is automatically reloaded, and the changed limit values are applied to the current measurement. Now a new save set with the updated limit values can be created.

## 11.5 Collecting Information for Support

If problems occur, the instrument generates error messages which in most cases will be sufficient for you to detect the cause of an error and find a remedy.

Error messages are described in [Chapter 11.1, "Error Information"](#), on page 963.

In addition, our customer support centers are there to assist you in solving any problems that you may encounter with your R&S FPL1000. We will find solutions more quickly and efficiently if you provide us with the information listed below.

- **Windows Event Log Files**

Windows records important actions of applications and the operating system in event logs. You can create event log files to summarize and save the existing event logs (see ["To create Windows event log files"](#) on page 969).

- **System Configuration:** The "System Configuration" dialog box (in the "Setup" menu) provides information on:

**System Configuration:** The "System Configuration" dialog box (in the "System Configuration" menu of the soft front panel) provides information on:

- **Hardware Info:** hardware assemblies
- **Versions and Options:** the status of all software and hardware options installed on your instrument
- **System Messages:** messages on any errors that may have occurred

An .xml file with information on the system configuration ( "Device Footprint" ) can be created automatically (using the `DIAGnostic:SERvice:SIInfo` command or as described in ["To collect the support information"](#) on page 968).

- **Error Log:** The `RSError.log` file (in the

`C:\ProgramData\Rohde-Schwarz\ZNL-FPL\log` directory) contains a chronological record of errors.

- **Support file:** a \*.zip file with important support information can be created automatically (in the `C:\ProgramData\Rohde-Schwarz\ZNL-FPL\user` directory).

The \*.zip file contains the system configuration information ( "Device Footprint" ), the current eeprom data and a screenshot of the screen display.

See also [Chapter 7.3.5.1, "R&S Support Information"](#), on page 148.

### To collect the support information

1. Press the [SETUP] key.
2. Select "Service" > "R&S Support" and then "Create R&S Support Information" .



The file is stored as

```
C:\ProgramData\Rohde-Schwarz\ZNL-FPL\user\
<inst_model>_<serial-no>_<date_and_time>.zip
```

For example

```
C:\ProgramData\Rohde-Schwarz\ZNL-FPL\user\
FPL1003__20160803_145113.zip
```

### To create Windows event log files



1. Select the "Windows Start Button" in the bottom left corner.
2. Type in *Event Viewer* and select "Enter".
3. Select and expand "Windows Logs" in the "Console Tree".
4. Right-click on each subsection and select "Save All Events As...".

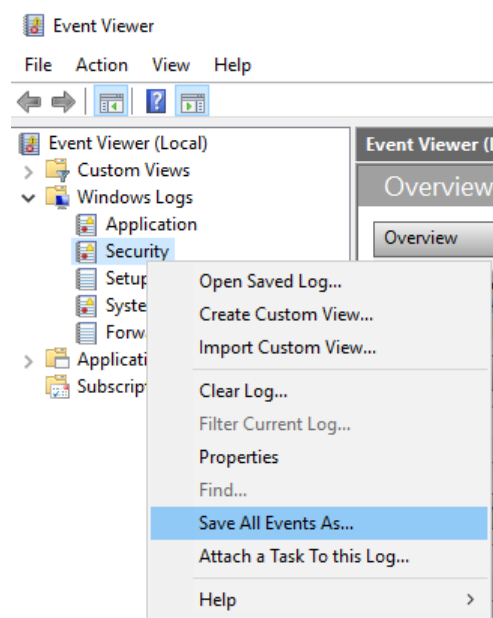

Figure 11-1: Event Viewer

5. Enter a file name and select "Save"

Collect the error information and attach it to an email in which you describe the problem. Send the email to the customer support address for your region as listed on the Internet (<http://www.customersupport.rohde-schwarz.com>).



### Packing and transporting the instrument

If the instrument needs to be transported or shipped, observe the notes described in [Chapter 5.1.1.1, "Unpacking and Checking the Instrument"](#), on page 15.

## List of Commands (Spectrum mode)

|                                                          |     |
|----------------------------------------------------------|-----|
| [SENSe:]WINDow<n>:DETEctor<t>[:FUNction].....            | 764 |
| [SENSe:]WINDow<n>:DETEctor<t>[:FUNction]:AUTO.....       | 765 |
| [SENSe:]ADJust:ALL.....                                  | 717 |
| [SENSe:]ADJust:CONFigure:DUration.....                   | 717 |
| [SENSe:]ADJust:CONFigure:DUration:MODE.....              | 718 |
| [SENSe:]ADJust:CONFigure:HYSTeresis:LOWer.....           | 718 |
| [SENSe:]ADJust:CONFigure:HYSTeresis:UPPer.....           | 718 |
| [SENSe:]ADJust:CONFigure:TRIGger.....                    | 719 |
| [SENSe:]ADJust:FREQuency.....                            | 719 |
| [SENSe:]ADJust:LEVel.....                                | 719 |
| [SENSe:]AVERAge<n>:COUNt.....                            | 763 |
| [SENSe:]AVERAge<n>:TYPE.....                             | 764 |
| [SENSe:]AVERAge<n>[:STATe<t>].....                       | 763 |
| [SENSe:]BANDwidth:VIDeo.....                             | 724 |
| [SENSe:]BANDwidth:VIDeo:AUTO.....                        | 724 |
| [SENSe:]BANDwidth:VIDeo:RATio.....                       | 724 |
| [SENSe:]BANDwidth:VIDeo:TYPE.....                        | 725 |
| [SENSe:]BANDwidth[:RESolution].....                      | 722 |
| [SENSe:]BANDwidth[:RESolution]:AUTO.....                 | 722 |
| [SENSe:]BANDwidth[:RESolution]:RATio.....                | 723 |
| [SENSe:]BANDwidth[:RESolution]:TYPE.....                 | 723 |
| [SENSe:]BWIDth:VIDeo.....                                | 724 |
| [SENSe:]BWIDth:VIDeo:AUTO.....                           | 724 |
| [SENSe:]BWIDth:VIDeo:RATio.....                          | 724 |
| [SENSe:]BWIDth:VIDeo:TYPE.....                           | 725 |
| [SENSe:]BWIDth[:RESolution].....                         | 722 |
| [SENSe:]BWIDth[:RESolution]:AUTO.....                    | 722 |
| [SENSe:]BWIDth[:RESolution]:RATio.....                   | 723 |
| [SENSe:]BWIDth[:RESolution]:TYPE.....                    | 723 |
| [SENSe:]CORRection:TRANsducer:ADJust:RLEVel[:STATe]..... | 895 |
| [SENSe:]CORRection:TRANsducer:CATalog?.....              | 895 |
| [SENSe:]CORRection:TRANsducer:COMMeNt.....               | 896 |
| [SENSe:]CORRection:TRANsducer:DATA.....                  | 896 |
| [SENSe:]CORRection:TRANsducer:DELeTe.....                | 897 |
| [SENSe:]CORRection:TRANsducer:SCALing.....               | 897 |
| [SENSe:]CORRection:TRANsducer:SELeCt.....                | 897 |
| [SENSe:]CORRection:TRANsducer:UNIT.....                  | 898 |
| [SENSe:]CORRection:TRANsducer[:STATe].....               | 897 |
| [SENSe:]DEMod:SQUelch:LEVel.....                         | 833 |
| [SENSe:]DEMod:SQUelch[:STATe].....                       | 834 |
| [SENSe:]ESpectrum<sb>:BWID.....                          | 633 |
| [SENSe:]ESpectrum<sb>:FILTer[:RRC]:ALPHa.....            | 633 |
| [SENSe:]ESpectrum<sb>:FILTer[:RRC][:STATe].....          | 634 |
| [SENSe:]ESpectrum<sb>:HSPeed.....                        | 620 |
| [SENSe:]ESpectrum<sb>:PRESet:REStoRe.....                | 617 |
| [SENSe:]ESpectrum<sb>:PRESet:StoRe.....                  | 617 |
| [SENSe:]ESpectrum<sb>:PRESet[:STANdard].....             | 616 |

|                                                                        |     |
|------------------------------------------------------------------------|-----|
| [SENSe:]ESpectrum<sb>:RANGe<ri>:BANdwidth:RESolution.....              | 620 |
| [SENSe:]ESpectrum<sb>:RANGe<ri>:BANdwidth:VIDeo.....                   | 621 |
| [SENSe:]ESpectrum<sb>:RANGe<ri>:COUNt?.....                            | 621 |
| [SENSe:]ESpectrum<sb>:RANGe<ri>:DELete.....                            | 621 |
| [SENSe:]ESpectrum<sb>:RANGe<ri>:FILTer:TYPE.....                       | 621 |
| [SENSe:]ESpectrum<sb>:RANGe<ri>:INPut:ATTenuation.....                 | 623 |
| [SENSe:]ESpectrum<sb>:RANGe<ri>:INPut:ATTenuation:AUTO.....            | 623 |
| [SENSe:]ESpectrum<sb>:RANGe<ri>:INPut:GAIN:STATe.....                  | 624 |
| [SENSe:]ESpectrum<sb>:RANGe<ri>:INPut:GAIN[:VALue].....                | 624 |
| [SENSe:]ESpectrum<sb>:RANGe<ri>:INSert.....                            | 624 |
| [SENSe:]ESpectrum<sb>:RANGe<ri>:LIMit<li>:ABSolute:START.....          | 625 |
| [SENSe:]ESpectrum<sb>:RANGe<ri>:LIMit<li>:ABSolute:STOP.....           | 625 |
| [SENSe:]ESpectrum<sb>:RANGe<ri>:LIMit<li>:RELative:START.....          | 626 |
| [SENSe:]ESpectrum<sb>:RANGe<ri>:LIMit<li>:RELative:START:ABS.....      | 626 |
| [SENSe:]ESpectrum<sb>:RANGe<ri>:LIMit<li>:RELative:START:FUNCTion..... | 627 |
| [SENSe:]ESpectrum<sb>:RANGe<ri>:LIMit<li>:RELative:STOP.....           | 628 |
| [SENSe:]ESpectrum<sb>:RANGe<ri>:LIMit<li>:RELative:STOP:ABS.....       | 628 |
| [SENSe:]ESpectrum<sb>:RANGe<ri>:LIMit<li>:RELative:STOP:FUNCTion.....  | 629 |
| [SENSe:]ESpectrum<sb>:RANGe<ri>:LIMit<li>:STATe.....                   | 629 |
| [SENSe:]ESpectrum<sb>:RANGe<ri>:MLCalc.....                            | 630 |
| [SENSe:]ESpectrum<sb>:RANGe<ri>:POINts:MINinum[:VALue].....            | 630 |
| [SENSe:]ESpectrum<sb>:RANGe<ri>:RLEVel.....                            | 631 |
| [SENSe:]ESpectrum<sb>:RANGe<ri>:SWEep:TIME.....                        | 631 |
| [SENSe:]ESpectrum<sb>:RANGe<ri>:SWEep:TIME:AUTO.....                   | 632 |
| [SENSe:]ESpectrum<sb>:RANGe<ri>:TRANsducer.....                        | 632 |
| [SENSe:]ESpectrum<sb>:RRANGe?.....                                     | 634 |
| [SENSe:]ESpectrum<sb>:RTYPE.....                                       | 634 |
| [SENSe:]ESpectrum<sb>:SCENter.....                                     | 618 |
| [SENSe:]ESpectrum<sb>:SCOUNt.....                                      | 619 |
| [SENSe:]ESpectrum<sb>:SSETup.....                                      | 633 |
| [SENSe:]FREQuency:CENTer.....                                          | 713 |
| [SENSe:]FREQuency:CENTer:STEP.....                                     | 714 |
| [SENSe:]FREQuency:CENTer:STEP:AUTO.....                                | 714 |
| [SENSe:]FREQuency:CENTer:STEP:LINK.....                                | 714 |
| [SENSe:]FREQuency:CENTer:STEP:LINK:FACTor.....                         | 715 |
| [SENSe:]FREQuency:OFFSet.....                                          | 715 |
| [SENSe:]FREQuency:SPAN.....                                            | 715 |
| [SENSe:]FREQuency:SPAN:FULL.....                                       | 716 |
| [SENSe:]FREQuency:START.....                                           | 716 |
| [SENSe:]FREQuency:STOP.....                                            | 716 |
| [SENSe:]LIST:POWer:RESult?.....                                        | 692 |
| [SENSe:]LIST:POWer:SET.....                                            | 694 |
| [SENSe:]LIST:POWer:STATe.....                                          | 694 |
| [SENSe:]LIST:POWer[:SEQuence].....                                     | 693 |
| [SENSe:]LIST:RANGe<ri>:BANdwidth:RESolution.....                       | 646 |
| [SENSe:]LIST:RANGe<ri>:BANdwidth:VIDeo.....                            | 646 |
| [SENSe:]LIST:RANGe<ri>:BREak.....                                      | 647 |
| [SENSe:]LIST:RANGe<ri>:COUNt?.....                                     | 647 |
| [SENSe:]LIST:RANGe<ri>:DELete.....                                     | 647 |
| [SENSe:]LIST:RANGe<ri>:DETEctor.....                                   | 647 |

|                                                          |     |
|----------------------------------------------------------|-----|
| [SENSe:]LIST:RANGe<ri>:FILTer:TYPE.....                  | 647 |
| [SENSe:]LIST:RANGe<ri>:INPut:ATTenuation.....            | 648 |
| [SENSe:]LIST:RANGe<ri>:INPut:ATTenuation:AUTO.....       | 648 |
| [SENSe:]LIST:RANGe<ri>:INPut:GAIN:STATe.....             | 648 |
| [SENSe:]LIST:RANGe<ri>:INPut:GAIN[:VALue].....           | 649 |
| [SENSe:]LIST:RANGe<ri>:LIMit:STARt.....                  | 649 |
| [SENSe:]LIST:RANGe<ri>:LIMit:STATe.....                  | 649 |
| [SENSe:]LIST:RANGe<ri>:LIMit:STOP.....                   | 649 |
| [SENSe:]LIST:RANGe<ri>:POINts[:VALue].....               | 650 |
| [SENSe:]LIST:RANGe<ri>:RLEVel.....                       | 650 |
| [SENSe:]LIST:RANGe<ri>:SWEep:TIME.....                   | 650 |
| [SENSe:]LIST:RANGe<ri>:SWEep:TIME:AUTO.....              | 650 |
| [SENSe:]LIST:RANGe<ri>:TRANsducer.....                   | 651 |
| [SENSe:]LIST:RANGe<ri>[:FREQuency]:STARt.....            | 622 |
| [SENSe:]LIST:RANGe<ri>[:FREQuency]:STOP.....             | 623 |
| [SENSe:]LIST:XADJust.....                                | 653 |
| [SENSe:]MPOWER:FTYPE.....                                | 697 |
| [SENSe:]MPOWER:RESult:MIN?.....                          | 699 |
| [SENSe:]MPOWER:RESult[:LIST]?.....                       | 698 |
| [SENSe:]MPOWER[:SEQuence].....                           | 698 |
| [SENSe:]PMETer<p>:DCYClE:VALue.....                      | 748 |
| [SENSe:]PMETer<p>:DCYClE[:STATe].....                    | 748 |
| [SENSe:]PMETer<p>:FREQuency.....                         | 749 |
| [SENSe:]PMETer<p>:FREQuency:LINK.....                    | 749 |
| [SENSe:]PMETer<p>:MTIME.....                             | 749 |
| [SENSe:]PMETer<p>:MTIME:AVERAge:COUnT.....               | 750 |
| [SENSe:]PMETer<p>:MTIME:AVERAge[:STATe].....             | 750 |
| [SENSe:]PMETer<p>:ROFFset[:STATe].....                   | 751 |
| [SENSe:]PMETer<p>:UPDate[:STATe].....                    | 751 |
| [SENSe:]PMETer<p>[:STATe].....                           | 751 |
| [SENSe:]POWER:ACHannel:ACPairs.....                      | 598 |
| [SENSe:]POWER:ACHannel:BANDwidth:ACHannel.....           | 598 |
| [SENSe:]POWER:ACHannel:BANDwidth:ALTerNate<ch>.....      | 598 |
| [SENSe:]POWER:ACHannel:BANDwidth[:CHANnel<ch>].....      | 598 |
| [SENSe:]POWER:ACHannel:BWIDth:ACHannel.....              | 598 |
| [SENSe:]POWER:ACHannel:BWIDth:ALTerNate<ch>.....         | 598 |
| [SENSe:]POWER:ACHannel:BWIDth[:CHANnel<ch>].....         | 598 |
| [SENSe:]POWER:ACHannel:FILTer:ALPHa:ACHannel.....        | 601 |
| [SENSe:]POWER:ACHannel:FILTer:ALPHa:ALTerNate<ch>.....   | 601 |
| [SENSe:]POWER:ACHannel:FILTer:ALPHa:CHANnel<ch>.....     | 602 |
| [SENSe:]POWER:ACHannel:FILTer:ALPHa[:ALL].....           | 601 |
| [SENSe:]POWER:ACHannel:FILTer[:STATe]:ACHannel.....      | 602 |
| [SENSe:]POWER:ACHannel:FILTer[:STATe]:ALTerNate<ch>..... | 602 |
| [SENSe:]POWER:ACHannel:FILTer[:STATe]:CHANnel<ch>.....   | 602 |
| [SENSe:]POWER:ACHannel:FILTer[:STATe][:ALL].....         | 602 |
| [SENSe:]POWER:ACHannel:MODE.....                         | 610 |
| [SENSe:]POWER:ACHannel:NAME:ACHannel.....                | 599 |
| [SENSe:]POWER:ACHannel:NAME:ALTerNate<ch>.....           | 599 |
| [SENSe:]POWER:ACHannel:NAME:CHANnel<ch>.....             | 599 |
| [SENSe:]POWER:ACHannel:PRESet.....                       | 594 |

|                                                        |     |
|--------------------------------------------------------|-----|
| [SENSe:]POWer:ACHannel:PRESet:RLEVel.....              | 595 |
| [SENSe:]POWer:ACHannel:REFerence:AUTO ONCE.....        | 603 |
| [SENSe:]POWer:ACHannel:REFerence:TXCHannel:AUTO.....   | 603 |
| [SENSe:]POWer:ACHannel:REFerence:TXCHannel:MANual..... | 603 |
| [SENSe:]POWer:ACHannel:SPACing:ALTErnate<ch>.....      | 600 |
| [SENSe:]POWer:ACHannel:SPACing:CHANnel<ch>.....        | 600 |
| [SENSe:]POWer:ACHannel:SPACing[:ACHannel].....         | 599 |
| [SENSe:]POWer:ACHannel:TXCHannel:COUNT.....            | 600 |
| [SENSe:]POWer:BANDwidth.....                           | 614 |
| [SENSe:]POWer:BWIDth.....                              | 614 |
| [SENSe:]POWer:TRACe.....                               | 595 |
| [SENSe:]ROSCillator:O100.....                          | 890 |
| [SENSe:]ROSCillator:SOURce.....                        | 890 |
| [SENSe:]SWEep:COUNT.....                               | 725 |
| [SENSe:]SWEep:COUNT:CURRent?.....                      | 591 |
| [SENSe:]SWEep:DURation?.....                           | 726 |
| [SENSe:]SWEep:EGATe.....                               | 739 |
| [SENSe:]SWEep:EGATe:HOLDoff.....                       | 740 |
| [SENSe:]SWEep:EGATe:LENGth.....                        | 740 |
| [SENSe:]SWEep:EGATe:POLarity.....                      | 740 |
| [SENSe:]SWEep:EGATe:SOURce.....                        | 741 |
| [SENSe:]SWEep:EGATe:TRACe<t>:COMMeNt.....              | 658 |
| [SENSe:]SWEep:EGATe:TRACe<t>:PERiod.....               | 658 |
| [SENSe:]SWEep:EGATe:TRACe<t>:STARt<gr>.....            | 658 |
| [SENSe:]SWEep:EGATe:TRACe<t>:STOP<gr>.....             | 659 |
| [SENSe:]SWEep:EGATe:TRACe<t>[:STATe<gr>].....          | 659 |
| [SENSe:]SWEep:EGATe:TYPE.....                          | 741 |
| [SENSe:]SWEep:MODE.....                                | 618 |
| [SENSe:]SWEep:OPTimize.....                            | 726 |
| [SENSe:]SWEep:TIME.....                                | 728 |
| [SENSe:]SWEep:TIME:AUTO.....                           | 728 |
| [SENSe:]SWEep:TYPE:USED.....                           | 728 |
| [SENSe:]SWEep[:WINDow<n>]:POINts.....                  | 727 |
| *CAL?.....                                             | 575 |
| *CLS.....                                              | 575 |
| *ESE.....                                              | 575 |
| *ESR?.....                                             | 575 |
| *IDN?.....                                             | 576 |
| *IST?.....                                             | 576 |
| *OPC.....                                              | 576 |
| *OPT?.....                                             | 576 |
| *PCB.....                                              | 576 |
| *PRE.....                                              | 577 |
| *PSC.....                                              | 577 |
| *RST.....                                              | 577 |
| *SRE.....                                              | 577 |
| *STB?.....                                             | 577 |
| *TRG.....                                              | 578 |
| *TST?.....                                             | 578 |
| *WAI.....                                              | 578 |

|                                                                              |     |
|------------------------------------------------------------------------------|-----|
| ABORT.....                                                                   | 588 |
| CALCulate<n>:DELTamarker<m>:AOFF.....                                        | 785 |
| CALCulate<n>:DELTamarker<m>:FUNCTION:BPOWer:MODE.....                        | 824 |
| CALCulate<n>:DELTamarker<m>:FUNCTION:BPOWer:RESult?.....                     | 825 |
| CALCulate<n>:DELTamarker<m>:FUNCTION:BPOWer:SPAN.....                        | 825 |
| CALCulate<n>:DELTamarker<m>:FUNCTION:BPOWer[:STATe].....                     | 826 |
| CALCulate<n>:DELTamarker<m>:FUNCTION:FIXed:RPOint:MAXimum[:PEAK].....        | 812 |
| CALCulate<n>:DELTamarker<m>:FUNCTION:FIXed:RPOint:X.....                     | 813 |
| CALCulate<n>:DELTamarker<m>:FUNCTION:FIXed:RPOint:Y.....                     | 813 |
| CALCulate<n>:DELTamarker<m>:FUNCTION:FIXed:RPOint:Y:OFFSet.....              | 814 |
| CALCulate<n>:DELTamarker<m>:FUNCTION:FIXed[:STATe].....                      | 814 |
| CALCulate<n>:DELTamarker<m>:FUNCTION:FMEasurement:DETEctor.....              | 684 |
| CALCulate<n>:DELTamarker<m>:FUNCTION:FMEasurement:DWELl.....                 | 685 |
| CALCulate<n>:DELTamarker<m>:FUNCTION:FMEasurement:LIMit<li>:LCONDition?..... | 688 |
| CALCulate<n>:DELTamarker<m>:FUNCTION:FMEasurement:LIMit<li>:LDELta?.....     | 689 |
| CALCulate<n>:DELTamarker<m>:FUNCTION:FMEasurement:PEAKsearch:AUTO.....       | 685 |
| CALCulate<n>:DELTamarker<m>:FUNCTION:FMEasurement:PSEarch:AUTO.....          | 685 |
| CALCulate<n>:DELTamarker<m>:FUNCTION:FMEasurement:RESult?.....               | 688 |
| CALCulate<n>:DELTamarker<m>:FUNCTION:FMEasurement[:STATe].....               | 683 |
| CALCulate<n>:DELTamarker<m>:FUNCTION:PNOise:AUTO.....                        | 820 |
| CALCulate<n>:DELTamarker<m>:FUNCTION:PNOise:RESult?.....                     | 820 |
| CALCulate<n>:DELTamarker<m>:FUNCTION:PNOise[:STATe].....                     | 821 |
| CALCulate<n>:DELTamarker<m>:LINK.....                                        | 785 |
| CALCulate<n>:DELTamarker<m>:MAXimum:LEFT.....                                | 799 |
| CALCulate<n>:DELTamarker<m>:MAXimum:NEXT.....                                | 799 |
| CALCulate<n>:DELTamarker<m>:MAXimum:RIGHT.....                               | 800 |
| CALCulate<n>:DELTamarker<m>:MAXimum[:PEAK].....                              | 800 |
| CALCulate<n>:DELTamarker<m>:MINimum:LEFT.....                                | 800 |
| CALCulate<n>:DELTamarker<m>:MINimum:NEXT.....                                | 800 |
| CALCulate<n>:DELTamarker<m>:MINimum:RIGHT.....                               | 801 |
| CALCulate<n>:DELTamarker<m>:MINimum[:PEAK].....                              | 801 |
| CALCulate<n>:DELTamarker<m>:MODE.....                                        | 786 |
| CALCulate<n>:DELTamarker<m>:MREFerence.....                                  | 786 |
| CALCulate<n>:DELTamarker<m>:SGRam:FRAMe.....                                 | 809 |
| CALCulate<n>:DELTamarker<m>:SGRam:SARea.....                                 | 809 |
| CALCulate<n>:DELTamarker<m>:SGRam:XY:MAXimum[:PEAK].....                     | 810 |
| CALCulate<n>:DELTamarker<m>:SGRam:XY:MINimum[:PEAK].....                     | 810 |
| CALCulate<n>:DELTamarker<m>:SGRam:Y:MAXimum:ABOVe.....                       | 810 |
| CALCulate<n>:DELTamarker<m>:SGRam:Y:MAXimum:BELow.....                       | 810 |
| CALCulate<n>:DELTamarker<m>:SGRam:Y:MAXimum:NEXT.....                        | 811 |
| CALCulate<n>:DELTamarker<m>:SGRam:Y:MAXimum[:PEAK].....                      | 811 |
| CALCulate<n>:DELTamarker<m>:SGRam:Y:MINimum:ABOVe.....                       | 811 |
| CALCulate<n>:DELTamarker<m>:SGRam:Y:MINimum:BELow.....                       | 811 |
| CALCulate<n>:DELTamarker<m>:SGRam:Y:MINimum:NEXT.....                        | 812 |
| CALCulate<n>:DELTamarker<m>:SGRam:Y:MINimum[:PEAK].....                      | 812 |
| CALCulate<n>:DELTamarker<m>:SPECTrogram:FRAMe.....                           | 809 |
| CALCulate<n>:DELTamarker<m>:SPECTrogram:SARea.....                           | 809 |
| CALCulate<n>:DELTamarker<m>:SPECTrogram:XY:MAXimum[:PEAK].....               | 810 |
| CALCulate<n>:DELTamarker<m>:SPECTrogram:XY:MINimum[:PEAK].....               | 810 |
| CALCulate<n>:DELTamarker<m>:SPECTrogram:Y:MAXimum:ABOVe.....                 | 810 |

|                                                                    |     |
|--------------------------------------------------------------------|-----|
| CALCulate<n>:DELTamarker<m>:SPECtrogram:Y:MAXimum:BELOW.....       | 810 |
| CALCulate<n>:DELTamarker<m>:SPECtrogram:Y:MAXimum:NEXT.....        | 811 |
| CALCulate<n>:DELTamarker<m>:SPECtrogram:Y:MAXimum[:PEAK].....      | 811 |
| CALCulate<n>:DELTamarker<m>:SPECtrogram:Y:MINimum:ABOVE.....       | 811 |
| CALCulate<n>:DELTamarker<m>:SPECtrogram:Y:MINimum:BELOW.....       | 811 |
| CALCulate<n>:DELTamarker<m>:SPECtrogram:Y:MINimum:NEXT.....        | 812 |
| CALCulate<n>:DELTamarker<m>:SPECtrogram:Y:MINimum[:PEAK].....      | 812 |
| CALCulate<n>:DELTamarker<m>:TRACe.....                             | 787 |
| CALCulate<n>:DELTamarker<m>:X.....                                 | 787 |
| CALCulate<n>:DELTamarker<m>:X:RELative?.....                       | 802 |
| CALCulate<n>:DELTamarker<m>:Y.....                                 | 802 |
| CALCulate<n>:DELTamarker<m>[:STATe].....                           | 787 |
| CALCulate<n>:DELTamarker<ms>:LINK:TO:MARKer<md>.....               | 785 |
| CALCulate<n>:DLINe<dl>.....                                        | 843 |
| CALCulate<n>:DLINe<dl>:STATe.....                                  | 843 |
| CALCulate<n>:ESPectrum:PEAKsearch:AUTO.....                        | 640 |
| CALCulate<n>:ESPectrum:PEAKsearch:DETailS.....                     | 652 |
| CALCulate<n>:ESPectrum:PEAKsearch:MARGIn.....                      | 641 |
| CALCulate<n>:ESPectrum:PEAKsearch:PSHow.....                       | 641 |
| CALCulate<n>:ESPectrum:PEAKsearch[:IMMEdiate].....                 | 640 |
| CALCulate<n>:ESPectrum:PSEArch:AUTO.....                           | 640 |
| CALCulate<n>:ESPectrum:PSEArch:DETailS.....                        | 652 |
| CALCulate<n>:ESPectrum:PSEArch:MARGIn.....                         | 641 |
| CALCulate<n>:ESPectrum:PSEArch:PSHow.....                          | 641 |
| CALCulate<n>:ESPectrum:PSEArch[:IMMEdiate].....                    | 640 |
| CALCulate<n>:FLINe<dl>.....                                        | 844 |
| CALCulate<n>:FLINe<dl>:STATe.....                                  | 844 |
| CALCulate<n>:LIMit<li>:ACPowEr:ACHannel:ABSolute.....              | 604 |
| CALCulate<n>:LIMit<li>:ACPowEr:ACHannel:ABSolute:STATe.....        | 604 |
| CALCulate<n>:LIMit<li>:ACPowEr:ACHannel:RESult?.....               | 605 |
| CALCulate<n>:LIMit<li>:ACPowEr:ACHannel[:RELative].....            | 605 |
| CALCulate<n>:LIMit<li>:ACPowEr:ACHannel[:RELative]:STATe.....      | 606 |
| CALCulate<n>:LIMit<li>:ACPowEr:ALTErnate<ch>:ABSolute.....         | 606 |
| CALCulate<n>:LIMit<li>:ACPowEr:ALTErnate<ch>:ABSolute:STATe.....   | 607 |
| CALCulate<n>:LIMit<li>:ACPowEr:ALTErnate<ch>:RESult?.....          | 608 |
| CALCulate<n>:LIMit<li>:ACPowEr:ALTErnate<ch>[:RELative].....       | 607 |
| CALCulate<n>:LIMit<li>:ACPowEr:ALTErnate<ch>[:RELative]:STATe..... | 608 |
| CALCulate<n>:LIMit<li>:ACPowEr[:STATe].....                        | 609 |
| CALCulate<n>:LIMit<li>:ACTive?.....                                | 855 |
| CALCulate<n>:LIMit<li>:CLEAr[:IMMEdiate].....                      | 858 |
| CALCulate<n>:LIMit<li>:COMMEnt.....                                | 846 |
| CALCulate<n>:LIMit<li>:CONTRol:DOMain.....                         | 847 |
| CALCulate<n>:LIMit<li>:CONTRol:MODE.....                           | 847 |
| CALCulate<n>:LIMit<li>:CONTRol:OFFSEt.....                         | 848 |
| CALCulate<n>:LIMit<li>:CONTRol:SHIFt.....                          | 848 |
| CALCulate<n>:LIMit<li>:CONTRol:SPACIng.....                        | 848 |
| CALCulate<n>:LIMit<li>:CONTRol[:DATA].....                         | 846 |
| CALCulate<n>:LIMit<li>:COPY.....                                   | 856 |
| CALCulate<n>:LIMit<li>:DELEte.....                                 | 856 |
| CALCulate<n>:LIMit<li>:ESPectrum<sb>:LIMItS.....                   | 635 |

|                                                                         |     |
|-------------------------------------------------------------------------|-----|
| CALCulate<n>:LIMit<li>:ESPectrum<sb>:MODE.....                          | 636 |
| CALCulate<n>:LIMit<li>:ESPectrum<sb>:PCLass<pc>:COUNT.....              | 637 |
| CALCulate<n>:LIMit<li>:ESPectrum<sb>:PCLass<pc>:LIMit[:STATE].....      | 638 |
| CALCulate<n>:LIMit<li>:ESPectrum<sb>:PCLass<pc>:MAXimum.....            | 639 |
| CALCulate<n>:LIMit<li>:ESPectrum<sb>:PCLass<pc>:MINimum.....            | 639 |
| CALCulate<n>:LIMit<li>:ESPectrum<sb>:PCLass<pc>[:EXCLusive].....        | 637 |
| CALCulate<n>:LIMit<li>:ESPectrum<sb>:RESTore.....                       | 616 |
| CALCulate<n>:LIMit<li>:ESPectrum<sb>:VALue.....                         | 636 |
| CALCulate<n>:LIMit<li>:FAIL?.....                                       | 858 |
| CALCulate<n>:LIMit<li>:LOWer:MARGin.....                                | 849 |
| CALCulate<n>:LIMit<li>:LOWer:MODE.....                                  | 849 |
| CALCulate<n>:LIMit<li>:LOWer:OFFSet.....                                | 850 |
| CALCulate<n>:LIMit<li>:LOWer:SHIFt.....                                 | 850 |
| CALCulate<n>:LIMit<li>:LOWer:SPACing.....                               | 850 |
| CALCulate<n>:LIMit<li>:LOWer:STATe.....                                 | 851 |
| CALCulate<n>:LIMit<li>:LOWer:THReshold.....                             | 851 |
| CALCulate<n>:LIMit<li>:LOWer[:DATA].....                                | 849 |
| CALCulate<n>:LIMit<li>:NAME.....                                        | 851 |
| CALCulate<n>:LIMit<li>:STATe.....                                       | 856 |
| CALCulate<n>:LIMit<li>:TRACe<t>.....                                    | 959 |
| CALCulate<n>:LIMit<li>:TRACe<t>:CHECK.....                              | 857 |
| CALCulate<n>:LIMit<li>:UNIT.....                                        | 852 |
| CALCulate<n>:LIMit<li>:UPPer:MARGin.....                                | 853 |
| CALCulate<n>:LIMit<li>:UPPer:MODE.....                                  | 853 |
| CALCulate<n>:LIMit<li>:UPPer:OFFSet.....                                | 853 |
| CALCulate<n>:LIMit<li>:UPPer:SHIFt.....                                 | 854 |
| CALCulate<n>:LIMit<li>:UPPer:SPACing.....                               | 854 |
| CALCulate<n>:LIMit<li>:UPPer:STATe.....                                 | 854 |
| CALCulate<n>:LIMit<li>:UPPer:THReshold.....                             | 855 |
| CALCulate<n>:LIMit<li>:UPPer[:DATA].....                                | 852 |
| CALCulate<n>:MARKer<m>:AOFF.....                                        | 788 |
| CALCulate<n>:MARKer<m>:COUNT.....                                       | 830 |
| CALCulate<n>:MARKer<m>:COUNT:FREQuency?.....                            | 830 |
| CALCulate<n>:MARKer<m>:COUNT:RESolution.....                            | 831 |
| CALCulate<n>:MARKer<m>:FUNction:BPOWer:AOFF.....                        | 822 |
| CALCulate<n>:MARKer<m>:FUNction:BPOWer:MODE.....                        | 823 |
| CALCulate<n>:MARKer<m>:FUNction:BPOWer:RESult?.....                     | 823 |
| CALCulate<n>:MARKer<m>:FUNction:BPOWer:SPAN.....                        | 824 |
| CALCulate<n>:MARKer<m>:FUNction:BPOWer[:STATe].....                     | 824 |
| CALCulate<n>:MARKer<m>:FUNction:CENTer.....                             | 712 |
| CALCulate<n>:MARKer<m>:FUNction:CSTep.....                              | 713 |
| CALCulate<n>:MARKer<m>:FUNction:DEModulation:CONTinuous.....            | 832 |
| CALCulate<n>:MARKer<m>:FUNction:DEModulation:HOLDoff.....               | 832 |
| CALCulate<n>:MARKer<m>:FUNction:DEModulation:SElect.....                | 833 |
| CALCulate<n>:MARKer<m>:FUNction:DEModulation[:STATe].....               | 833 |
| CALCulate<n>:MARKer<m>:FUNction:FMEasurement:DETEctor.....              | 684 |
| CALCulate<n>:MARKer<m>:FUNction:FMEasurement:DWELl.....                 | 685 |
| CALCulate<n>:MARKer<m>:FUNction:FMEasurement:LIMit<li>:LCONDition?..... | 688 |
| CALCulate<n>:MARKer<m>:FUNction:FMEasurement:LIMit<li>:LDELta?.....     | 689 |
| CALCulate<n>:MARKer<m>:FUNction:FMEasurement:PEAKsearch:AUTO.....       | 685 |



|                                                                      |     |
|----------------------------------------------------------------------|-----|
| CALCulate<n>:MARKer<m>:FUNction:FMEasurement:PSEarch:AUTO.....       | 685 |
| CALCulate<n>:MARKer<m>:FUNction:FMEasurement:RESult?.....            | 688 |
| CALCulate<n>:MARKer<m>:FUNction:FMEasurement[:STATe].....            | 683 |
| CALCulate<n>:MARKer<m>:FUNction:FPEaks:ANNotation:LABel[:STATe]..... | 815 |
| CALCulate<n>:MARKer<m>:FUNction:FPEaks:COUNT?.....                   | 815 |
| CALCulate<n>:MARKer<m>:FUNction:FPEaks:LIST:SIZE.....                | 816 |
| CALCulate<n>:MARKer<m>:FUNction:FPEaks:SORT.....                     | 816 |
| CALCulate<n>:MARKer<m>:FUNction:FPEaks:STATe.....                    | 817 |
| CALCulate<n>:MARKer<m>:FUNction:FPEaks:X?.....                       | 817 |
| CALCulate<n>:MARKer<m>:FUNction:FPEaks:Y?.....                       | 817 |
| CALCulate<n>:MARKer<m>:FUNction:FPEaks[:IMMediate].....              | 816 |
| CALCulate<n>:MARKer<m>:FUNction:HARMonics:BANDwidth:AUTO.....        | 676 |
| CALCulate<n>:MARKer<m>:FUNction:HARMonics:DISTortion?.....           | 677 |
| CALCulate<n>:MARKer<m>:FUNction:HARMonics:LIST.....                  | 677 |
| CALCulate<n>:MARKer<m>:FUNction:HARMonics:NHARmonics.....            | 676 |
| CALCulate<n>:MARKer<m>:FUNction:HARMonics:PRESet.....                | 676 |
| CALCulate<n>:MARKer<m>:FUNction:HARMonics[:STATe].....               | 675 |
| CALCulate<n>:MARKer<m>:FUNction:MDEPth:RESult<t>?.....               | 682 |
| CALCulate<n>:MARKer<m>:FUNction:MDEPth:SEARChsignal ONCE.....        | 681 |
| CALCulate<n>:MARKer<m>:FUNction:MDEPth[:STATe].....                  | 681 |
| CALCulate<n>:MARKer<m>:FUNction:MSUMmary.....                        | 697 |
| CALCulate<n>:MARKer<m>:FUNction:NDBDown.....                         | 826 |
| CALCulate<n>:MARKer<m>:FUNction:NDBDown:FREQUency?.....              | 827 |
| CALCulate<n>:MARKer<m>:FUNction:NDBDown:QFACtor?.....                | 828 |
| CALCulate<n>:MARKer<m>:FUNction:NDBDown:RESult?.....                 | 828 |
| CALCulate<n>:MARKer<m>:FUNction:NDBDown:STATe.....                   | 828 |
| CALCulate<n>:MARKer<m>:FUNction:NDBDown:TIME?.....                   | 829 |
| CALCulate<n>:MARKer<m>:FUNction:NOISe:AOFF.....                      | 818 |
| CALCulate<n>:MARKer<m>:FUNction:NOISe:RESult?.....                   | 818 |
| CALCulate<n>:MARKer<m>:FUNction:NOISe[:STATe].....                   | 819 |
| CALCulate<n>:MARKer<m>:FUNction:PNOise:AOFF.....                     | 821 |
| CALCulate<n>:MARKer<m>:FUNction:PNOise:RESult?.....                  | 821 |
| CALCulate<n>:MARKer<m>:FUNction:PNOise[:STATe].....                  | 822 |
| CALCulate<n>:MARKer<m>:FUNction:POWer<sb>:MODE.....                  | 591 |
| CALCulate<n>:MARKer<m>:FUNction:POWer<sb>:PRESet.....                | 596 |
| CALCulate<n>:MARKer<m>:FUNction:POWer<sb>:RESult:PHZ.....            | 610 |
| CALCulate<n>:MARKer<m>:FUNction:POWer<sb>:RESult?.....               | 592 |
| CALCulate<n>:MARKer<m>:FUNction:POWer<sb>:SELect.....                | 593 |
| CALCulate<n>:MARKer<m>:FUNction:POWer<sb>:STANDard:CATalog?.....     | 596 |
| CALCulate<n>:MARKer<m>:FUNction:POWer<sb>:STANDard:DELeTe.....       | 597 |
| CALCulate<n>:MARKer<m>:FUNction:POWer<sb>:STANDard:SAVE.....         | 597 |
| CALCulate<n>:MARKer<m>:FUNction:POWer<sb>[:STATe].....               | 594 |
| CALCulate<n>:MARKer<m>:FUNction:REFerence.....                       | 729 |
| CALCulate<n>:MARKer<m>:FUNction:STRack:BANDwidth.....                | 720 |
| CALCulate<n>:MARKer<m>:FUNction:STRack:THReshold.....                | 721 |
| CALCulate<n>:MARKer<m>:FUNction:STRack:TRACe.....                    | 721 |
| CALCulate<n>:MARKer<m>:FUNction:STRack[:STATe].....                  | 720 |
| CALCulate<n>:MARKer<m>:FUNction:SUMMery:AOFF.....                    | 666 |
| CALCulate<n>:MARKer<m>:FUNction:SUMMery:AVERAge.....                 | 666 |
| CALCulate<n>:MARKer<m>:FUNction:SUMMery:MEAN:AVERAge:RESult?.....    | 669 |

|                                                                         |     |
|-------------------------------------------------------------------------|-----|
| CALCulate<n>:MARKer<m>:FUNction:SUMMary:MEAN:PHOLd:RESult?.....         | 669 |
| CALCulate<n>:MARKer<m>:FUNction:SUMMary:MEAN:RESult?.....               | 670 |
| CALCulate<n>:MARKer<m>:FUNction:SUMMary:MEAN[:STATe].....               | 667 |
| CALCulate<n>:MARKer<m>:FUNction:SUMMary:PHOLd.....                      | 667 |
| CALCulate<n>:MARKer<m>:FUNction:SUMMary:PPEak:AVERage:RESult?.....      | 670 |
| CALCulate<n>:MARKer<m>:FUNction:SUMMary:PPEak:PHOLd:RESult?.....        | 670 |
| CALCulate<n>:MARKer<m>:FUNction:SUMMary:PPEak:RESult?.....              | 671 |
| CALCulate<n>:MARKer<m>:FUNction:SUMMary:PPEak[:STATe].....              | 668 |
| CALCulate<n>:MARKer<m>:FUNction:SUMMary:RMS:AVERage:RESult?.....        | 671 |
| CALCulate<n>:MARKer<m>:FUNction:SUMMary:RMS:PHOLd:RESult?.....          | 672 |
| CALCulate<n>:MARKer<m>:FUNction:SUMMary:RMS:RESult?.....                | 672 |
| CALCulate<n>:MARKer<m>:FUNction:SUMMary:RMS[:STATe].....                | 668 |
| CALCulate<n>:MARKer<m>:FUNction:SUMMary:SDEViation:AVERage:RESult?..... | 672 |
| CALCulate<n>:MARKer<m>:FUNction:SUMMary:SDEViation:PHOLd:RESult?.....   | 673 |
| CALCulate<n>:MARKer<m>:FUNction:SUMMary:SDEViation:RESult?.....         | 673 |
| CALCulate<n>:MARKer<m>:FUNction:SUMMary:SDEViation[:STATe].....         | 668 |
| CALCulate<n>:MARKer<m>:FUNction:SUMMary[:STATe].....                    | 667 |
| CALCulate<n>:MARKer<m>:FUNction:TOI:RESult?.....                        | 680 |
| CALCulate<n>:MARKer<m>:FUNction:TOI:SEARChsignal ONCE.....              | 679 |
| CALCulate<n>:MARKer<m>:FUNction:TOI[:STATe].....                        | 679 |
| CALCulate<n>:MARKer<m>:LOEXclude.....                                   | 792 |
| CALCulate<n>:MARKer<m>:MAXimum:AUTO.....                                | 796 |
| CALCulate<n>:MARKer<m>:MAXimum:LEFT.....                                | 796 |
| CALCulate<n>:MARKer<m>:MAXimum:NEXT.....                                | 796 |
| CALCulate<n>:MARKer<m>:MAXimum:RIGHT.....                               | 797 |
| CALCulate<n>:MARKer<m>:MAXimum[:PEAK].....                              | 797 |
| CALCulate<n>:MARKer<m>:MINimum:AUTO.....                                | 797 |
| CALCulate<n>:MARKer<m>:MINimum:LEFT.....                                | 798 |
| CALCulate<n>:MARKer<m>:MINimum:NEXT.....                                | 798 |
| CALCulate<n>:MARKer<m>:MINimum:RIGHT.....                               | 798 |
| CALCulate<n>:MARKer<m>:MINimum[:PEAK].....                              | 798 |
| CALCulate<n>:MARKer<m>:PEXCursion.....                                  | 792 |
| CALCulate<n>:MARKer<m>:SGRam:FRAMe.....                                 | 804 |
| CALCulate<n>:MARKer<m>:SGRam:SARea.....                                 | 805 |
| CALCulate<n>:MARKer<m>:SGRam:XY:MAXimum[:PEAK].....                     | 805 |
| CALCulate<n>:MARKer<m>:SGRam:XY:MINimum[:PEAK].....                     | 805 |
| CALCulate<n>:MARKer<m>:SGRam:Y:MAXimum:ABOVe.....                       | 805 |
| CALCulate<n>:MARKer<m>:SGRam:Y:MAXimum:BELow.....                       | 806 |
| CALCulate<n>:MARKer<m>:SGRam:Y:MAXimum:NEXT.....                        | 806 |
| CALCulate<n>:MARKer<m>:SGRam:Y:MAXimum[:PEAK].....                      | 806 |
| CALCulate<n>:MARKer<m>:SGRam:Y:MINimum:ABOVe.....                       | 806 |
| CALCulate<n>:MARKer<m>:SGRam:Y:MINimum:BELow.....                       | 807 |
| CALCulate<n>:MARKer<m>:SGRam:Y:MINimum:NEXT.....                        | 807 |
| CALCulate<n>:MARKer<m>:SGRam:Y:MINimum[:PEAK].....                      | 807 |
| CALCulate<n>:MARKer<m>:SPECTrogram:FRAMe.....                           | 804 |
| CALCulate<n>:MARKer<m>:SPECTrogram:SARea.....                           | 805 |
| CALCulate<n>:MARKer<m>:SPECTrogram:XY:MAXimum[:PEAK].....               | 805 |
| CALCulate<n>:MARKer<m>:SPECTrogram:XY:MINimum[:PEAK].....               | 805 |
| CALCulate<n>:MARKer<m>:SPECTrogram:Y:MAXimum:ABOVe.....                 | 805 |
| CALCulate<n>:MARKer<m>:SPECTrogram:Y:MAXimum:BELow.....                 | 806 |

|                                                            |     |
|------------------------------------------------------------|-----|
| CALCulate<n>:MARKer<m>:SPECTrogram:Y:MAXimum:NEXT.....     | 806 |
| CALCulate<n>:MARKer<m>:SPECTrogram:Y:MAXimum[:PEAK].....   | 806 |
| CALCulate<n>:MARKer<m>:SPECTrogram:Y:MINimum:ABOVE.....    | 806 |
| CALCulate<n>:MARKer<m>:SPECTrogram:Y:MINimum:BELOW.....    | 807 |
| CALCulate<n>:MARKer<m>:SPECTrogram:Y:MINimum:NEXT.....     | 807 |
| CALCulate<n>:MARKer<m>:SPECTrogram:Y:MINimum[:PEAK].....   | 807 |
| CALCulate<n>:MARKer<m>:TRACe.....                          | 789 |
| CALCulate<n>:MARKer<m>:X.....                              | 789 |
| CALCulate<n>:MARKer<m>:X:SLIMits:LEFT.....                 | 793 |
| CALCulate<n>:MARKer<m>:X:SLIMits:RIGHT.....                | 794 |
| CALCulate<n>:MARKer<m>:X:SLIMits:ZOOM[:STATe].....         | 794 |
| CALCulate<n>:MARKer<m>:X:SLIMits[:STATe].....              | 793 |
| CALCulate<n>:MARKer<m>:X:SSIZe.....                        | 791 |
| CALCulate<n>:MARKer<m>:Y.....                              | 803 |
| CALCulate<n>:MARKer<m>:Y:PERCent.....                      | 657 |
| CALCulate<n>:MARKer<m>[:STATe].....                        | 789 |
| CALCulate<n>:MARKer<ms>:LINK:TO:MARKer<md>.....            | 788 |
| CALCulate<n>:MATH<t>:MODE.....                             | 774 |
| CALCulate<n>:MATH<t>:POSition.....                         | 774 |
| CALCulate<n>:MATH<t>:STATe.....                            | 775 |
| CALCulate<n>:MATH<t>[:EXPReSSion][:DEFine].....            | 773 |
| CALCulate<n>:PEAKsearch:AUTO.....                          | 652 |
| CALCulate<n>:PEAKsearch:MARGIn.....                        | 652 |
| CALCulate<n>:PEAKsearch:PSHow.....                         | 653 |
| CALCulate<n>:PEAKsearch:SUBRanges.....                     | 653 |
| CALCulate<n>:PMETer<p>:RELative:STATe.....                 | 747 |
| CALCulate<n>:PMETer<p>:RELative[:MAGNitude].....           | 747 |
| CALCulate<n>:PMETer<p>:RELative[:MAGNitude]:AUTO ONCE..... | 747 |
| CALCulate<n>:PSEArch:AUTO.....                             | 652 |
| CALCulate<n>:PSEArch:MARGIn.....                           | 652 |
| CALCulate<n>:PSEArch:PSHow.....                            | 653 |
| CALCulate<n>:PSEArch:SUBRanges.....                        | 653 |
| CALCulate<n>:SGRam:CLEAr[:IMMEdiate].....                  | 766 |
| CALCulate<n>:SGRam:CONTInuous.....                         | 767 |
| CALCulate<n>:SGRam:FRAMe:COUNT.....                        | 767 |
| CALCulate<n>:SGRam:FRAMe:SELEct.....                       | 768 |
| CALCulate<n>:SGRam:HDEPth.....                             | 768 |
| CALCulate<n>:SGRam:LAYOut.....                             | 768 |
| CALCulate<n>:SGRam:THReedim[:STATe].....                   | 769 |
| CALCulate<n>:SGRam:TRACe.....                              | 770 |
| CALCulate<n>:SGRam:TSTamp:DATA?.....                       | 770 |
| CALCulate<n>:SGRam:TSTamp[:STATe].....                     | 771 |
| CALCulate<n>:SGRam[:STATe].....                            | 769 |
| CALCulate<n>:SPECTrogram:CLEAr[:IMMEdiate].....            | 766 |
| CALCulate<n>:SPECTrogram:CONTInuous.....                   | 767 |
| CALCulate<n>:SPECTrogram:FRAMe:COUNT.....                  | 767 |
| CALCulate<n>:SPECTrogram:FRAMe:SELEct.....                 | 768 |
| CALCulate<n>:SPECTrogram:HDEPth.....                       | 768 |
| CALCulate<n>:SPECTrogram:LAYOut.....                       | 768 |
| CALCulate<n>:SPECTrogram:THReedim[:STATe].....             | 769 |

|                                                  |     |
|--------------------------------------------------|-----|
| CALCulate<n>:SPECTrogram:TRACe.....              | 770 |
| CALCulate<n>:SPECTrogram:TSTamp:DATA?.....       | 770 |
| CALCulate<n>:SPECTrogram:TSTamp[:STATe].....     | 771 |
| CALCulate<n>:SPECTrogram[:STATe].....            | 769 |
| CALCulate<n>:STATistics:APD[:STATe].....         | 656 |
| CALCulate<n>:STATistics:CCDF:X<t>?.....          | 663 |
| CALCulate<n>:STATistics:CCDF[:STATe].....        | 656 |
| CALCulate<n>:STATistics:NSAMples.....            | 657 |
| CALCulate<n>:STATistics:PRESet.....              | 660 |
| CALCulate<n>:STATistics:RESult<res>?.....        | 663 |
| CALCulate<n>:STATistics:SCALE:AUTO ONCE.....     | 660 |
| CALCulate<n>:STATistics:SCALE:X:RANGe.....       | 661 |
| CALCulate<n>:STATistics:SCALE:X:RLEVel.....      | 661 |
| CALCulate<n>:STATistics:SCALE:Y:LOWer.....       | 661 |
| CALCulate<n>:STATistics:SCALE:Y:UNIT.....        | 662 |
| CALCulate<n>:STATistics:SCALE:Y:UPPer.....       | 662 |
| CALCulate<n>:THReshold.....                      | 795 |
| CALCulate<n>:THReshold:STATe.....                | 795 |
| CALCulate<n>:TLINe<dl>.....                      | 844 |
| CALCulate<n>:TLINe<dl>:STATe.....                | 845 |
| CALCulate<n>:UNIT:POWER.....                     | 729 |
| CALibration:PMETer<p>:ZERO:AUTO ONCE.....        | 746 |
| CALibration:RESult?.....                         | 892 |
| CALibration[:ALL].....                           | 891 |
| DIAGnostic:SERVice:BATTery:LEVel?.....           | 908 |
| DIAGnostic:SERVice:BIOSinfo?.....                | 908 |
| DIAGnostic:SERVice:HWINfo?.....                  | 909 |
| DIAGnostic:SERVice:INPut:MC:CFRequency.....      | 892 |
| DIAGnostic:SERVice:INPut:MC[:DISTance].....      | 892 |
| DIAGnostic:SERVice:INPut:PULSed:CFRequency.....  | 892 |
| DIAGnostic:SERVice:INPut:PULSed:MCFRequency..... | 893 |
| DIAGnostic:SERVice:INPut:PULSed:WBFRequency..... | 893 |
| DIAGnostic:SERVice:INPut:RF[:SPECTrum].....      | 893 |
| DIAGnostic:SERVice:INPut[:SElect].....           | 894 |
| DIAGnostic:SERVice:NSOource.....                 | 753 |
| DIAGnostic:SERVice:SFUNction.....                | 912 |
| DIAGnostic:SERVice:SFUNction:LASTresult?.....    | 912 |
| DIAGnostic:SERVice:SFUNction:RESults:DELeTe..... | 913 |
| DIAGnostic:SERVice:SFUNction:RESults:SAVE.....   | 913 |
| DIAGnostic:SERVice:SINFo?.....                   | 913 |
| DIAGnostic:SERVice:STESt:RESult?.....            | 894 |
| DIAGnostic:SERVice:VERSinfo?.....                | 909 |
| DISPlay:ANNotation:CBAR.....                     | 899 |
| DISPlay:ANNotation:FREquency.....                | 900 |
| DISPlay:ATAB.....                                | 580 |
| DISPlay:BLIGHting.....                           | 900 |
| DISPlay:CMAP<it>:DEFault<ci>.....                | 902 |
| DISPlay:LOGO.....                                | 877 |
| DISPlay:SBAR[:STATe].....                        | 900 |
| DISPlay:SKEYs[:STATe].....                       | 900 |

|                                                                     |     |
|---------------------------------------------------------------------|-----|
| DISPlay:TBAR[:STATe].....                                           | 900 |
| DISPlay:THEMe:CATalog?.....                                         | 903 |
| DISPlay:THEMe:SElect.....                                           | 903 |
| DISPlay:TOUCHscreen[:STATe].....                                    | 901 |
| DISPlay[:WINDow<n>]:MINFo[:STATe].....                              | 791 |
| DISPlay[:WINDow<n>]:MTABle.....                                     | 790 |
| DISPlay[:WINDow<n>]:SGRam:COLor:DEFault.....                        | 771 |
| DISPlay[:WINDow<n>]:SGRam:COLor:LOWer.....                          | 772 |
| DISPlay[:WINDow<n>]:SGRam:COLor:SHAPE.....                          | 772 |
| DISPlay[:WINDow<n>]:SGRam:COLor:UPPer.....                          | 772 |
| DISPlay[:WINDow<n>]:SGRam:COLor[:STYLe].....                        | 773 |
| DISPlay[:WINDow<n>]:SPECTrogram:COLor:DEFault.....                  | 771 |
| DISPlay[:WINDow<n>]:SPECTrogram:COLor:LOWer.....                    | 772 |
| DISPlay[:WINDow<n>]:SPECTrogram:COLor:SHAPE.....                    | 772 |
| DISPlay[:WINDow<n>]:SPECTrogram:COLor:UPPer.....                    | 772 |
| DISPlay[:WINDow<n>]:SPECTrogram:COLor[:STYLe].....                  | 773 |
| DISPlay[:WINDow<n>]:STATe.....                                      | 960 |
| DISPlay[:WINDow<n>]:TIME.....                                       | 901 |
| DISPlay[:WINDow<n>]:TIME:FORMat.....                                | 901 |
| DISPlay[:WINDow<n>]:TRACe<t>:MODE.....                              | 760 |
| DISPlay[:WINDow<n>]:TRACe<t>:Y[:SCALE].....                         | 732 |
| DISPlay[:WINDow<n>]:TRACe<t>:Y[:SCALE]:AUTO ONCE.....               | 733 |
| DISPlay[:WINDow<n>]:TRACe<t>:Y[:SCALE]:RLEVel.....                  | 730 |
| DISPlay[:WINDow<n>]:TRACe<t>:Y[:SCALE]:RLEVel:OFFSet.....           | 730 |
| DISPlay[:WINDow<n>]:TRACe<t>:Y[:SCALE]:RPOStion.....                | 733 |
| DISPlay[:WINDow<n>]:TYPE.....                                       | 960 |
| DISPlay[:WINDow<n>][:SUBWIndow<w>]:TRACe<t>:MODE:HCONtinuous.....   | 761 |
| DISPlay[:WINDow<n>][:SUBWIndow<w>]:TRACe<t>:SMOothing:APERture..... | 762 |
| DISPlay[:WINDow<n>][:SUBWIndow<w>]:TRACe<t>:SMOothing[:STATe].....  | 762 |
| DISPlay[:WINDow<n>][:SUBWIndow<w>]:TRACe<t>:X:SPACing.....          | 713 |
| DISPlay[:WINDow<n>][:SUBWIndow<w>]:TRACe<t>:Y:SPACing.....          | 734 |
| DISPlay[:WINDow<n>][:SUBWIndow<w>]:TRACe<t>:Y[:SCALE]:MODE.....     | 733 |
| DISPlay[:WINDow<n>][:SUBWIndow<w>]:TRACe<t>[:STATe].....            | 762 |
| DISPlay[:WINDow<n>][:SUBWIndow<w>]:ZOOM:AREA.....                   | 756 |
| DISPlay[:WINDow<n>][:SUBWIndow<w>]:ZOOM:MULTiple<zn>:AREA.....      | 758 |
| DISPlay[:WINDow<n>][:SUBWIndow<w>]:ZOOM:MULTiple<zn>[:STATe].....   | 759 |
| DISPlay[:WINDow<n>][:SUBWIndow<w>]:ZOOM[:STATe].....                | 757 |
| FETCh:PMETer<p>?.....                                               | 748 |
| FORMat:DEXPort:DSEParator.....                                      | 863 |
| FORMat:DEXPort:FORMat.....                                          | 779 |
| FORMat:DEXPort:HEADer.....                                          | 886 |
| FORMat:DEXPort:TRACes.....                                          | 780 |
| FORMat:DIMPort:TRACes.....                                          | 780 |
| FORMat[:DATA].....                                                  | 776 |
| HCOPY:ABORt.....                                                    | 877 |
| HCOPY:CMAP<it>:DEFault<ci>.....                                     | 878 |
| HCOPY:CONTEnt.....                                                  | 877 |
| HCOPY:DESTination<device>.....                                      | 878 |
| HCOPY:DEVice:COLor.....                                             | 879 |
| HCOPY:DEVice:LANGUage<device>.....                                  | 879 |

|                                             |     |
|---------------------------------------------|-----|
| HCOPY:ITEM:ALL.....                         | 960 |
| HCOPY:ITEM:WINDow<n>:TEXT.....              | 880 |
| HCOPY:PAGE:COUNT:STATE.....                 | 880 |
| HCOPY:PAGE:MARGIn<device>:BOTTom.....       | 881 |
| HCOPY:PAGE:MARGIn<device>:LEFT.....         | 881 |
| HCOPY:PAGE:MARGIn<device>:RIGHT.....        | 881 |
| HCOPY:PAGE:MARGIn<device>:TOP.....          | 882 |
| HCOPY:PAGE:MARGIn<device>:UNIT.....         | 882 |
| HCOPY:PAGE:ORientation<device>.....         | 882 |
| HCOPY:PAGE:WINDow<n>:CHANnel:STATE.....     | 883 |
| HCOPY:PAGE:WINDow<n>:COUNT.....             | 883 |
| HCOPY:PAGE:WINDow<n>:SCALE.....             | 884 |
| HCOPY:PAGE:WINDow<n>:STATE.....             | 884 |
| HCOPY:TDSamp:STATE<device>.....             | 885 |
| HCOPY[:IMMEDIATE<device>].....              | 880 |
| HCOPY[:IMMEDIATE<device>]:NEXT.....         | 880 |
| INITiate:SEQuencer:ABORT.....               | 583 |
| INITiate:SEQuencer:IMMEDIATE.....           | 584 |
| INITiate:SEQuencer:MODE.....                | 584 |
| INITiate<n>:CONMeas.....                    | 589 |
| INITiate<n>:CONTInuous.....                 | 589 |
| INITiate<n>:ESpectrum.....                  | 617 |
| INITiate<n>:SPURious.....                   | 645 |
| INITiate<n>[:IMMEDIATE].....                | 590 |
| INPut<ip>:ATTenuation.....                  | 731 |
| INPut<ip>:ATTenuation:AUTO.....             | 731 |
| INPut<ip>:ATTenuation:PROTection:RESet..... | 742 |
| INPut<ip>:EATT:AUTO.....                    | 731 |
| INPut<ip>:FILTer:SAW.....                   | 742 |
| INPut<ip>:GAIN:STATE.....                   | 732 |
| INPut<ip>:IMPedance.....                    | 743 |
| INPut<ip>:LISN:FILTer:HPASS[:STATE].....    | 686 |
| INPut<ip>:LISN:PHASe.....                   | 686 |
| INPut<ip>:LISN[:TYPE].....                  | 687 |
| INPut<ip>:SElect.....                       | 743 |
| INPut<ip>:UPORt:STATE.....                  | 743 |
| INPut<ip>:UPORt[:VALue].....                | 744 |
| INSTrument:CREate:DUPLicate.....            | 580 |
| INSTrument:CREate:REPLace.....              | 581 |
| INSTrument:CREate[:NEW].....                | 580 |
| INSTrument:DELeTe.....                      | 581 |
| INSTrument:LIST?.....                       | 581 |
| INSTrument:REName.....                      | 582 |
| INSTrument[:SElect].....                    | 583 |
| LAYout:ADD[:WINDow]?.....                   | 703 |
| LAYout:CATalog[:WINDow]?.....               | 704 |
| LAYout:IDENtify[:WINDow]?.....              | 704 |
| LAYout:MOVE[:WINDow].....                   | 705 |
| LAYout:REMOve[:WINDow].....                 | 705 |
| LAYout:REPLace[:WINDow].....                | 706 |

|                                                   |     |
|---------------------------------------------------|-----|
| LAYout:SPLitter.....                              | 706 |
| LAYout:WINDow<n>:ADD?.....                        | 707 |
| LAYout:WINDow<n>:IDENtify?.....                   | 708 |
| LAYout:WINDow<n>:REMOve.....                      | 708 |
| LAYout:WINDow<n>:REPLace.....                     | 708 |
| MMEMory:CATalog.....                              | 863 |
| MMEMory:CATalog:LONG.....                         | 864 |
| MMEMory:CDIRectory.....                           | 864 |
| MMEMory:CLEar:ALL.....                            | 872 |
| MMEMory:CLEar:STATe.....                          | 872 |
| MMEMory:COMMeNt.....                              | 864 |
| MMEMory:COpy.....                                 | 865 |
| MMEMory:DATA.....                                 | 865 |
| MMEMory:DELEte[:IMMediate].....                   | 866 |
| MMEMory:LOAD:AUTO.....                            | 872 |
| MMEMory:LOAD:STATe.....                           | 873 |
| MMEMory:LOAD:TYPE.....                            | 874 |
| MMEMory:LOAD<n>:LIMit.....                        | 857 |
| MMEMory:LOAD<n>:TFACtor.....                      | 898 |
| MMEMory:LOAD<n>:TRACe.....                        | 781 |
| MMEMory:MDIRectory.....                           | 866 |
| MMEMory:MOVE.....                                 | 866 |
| MMEMory:MSIS.....                                 | 866 |
| MMEMory:NAME.....                                 | 866 |
| MMEMory:NETWork:DISConnect.....                   | 867 |
| MMEMory:NETWork:MAP.....                          | 867 |
| MMEMory:NETWork:UNUSeddrives?.....                | 868 |
| MMEMory:NETWork:USEDdrives.....                   | 868 |
| MMEMory:RDIRectory.....                           | 868 |
| MMEMory:SELEct:CHANnel[:ITEM]:ALL.....            | 869 |
| MMEMory:SELEct:CHANnel[:ITEM]:DEFault.....        | 869 |
| MMEMory:SELEct:CHANnel[:ITEM]:HWSettings.....     | 869 |
| MMEMory:SELEct:CHANnel[:ITEM]:LINES:ALL.....      | 870 |
| MMEMory:SELEct:CHANnel[:ITEM]:NONE.....           | 870 |
| MMEMory:SELEct:CHANnel[:ITEM]:SGRam.....          | 870 |
| MMEMory:SELEct:CHANnel[:ITEM]:SPECTrogram.....    | 870 |
| MMEMory:SELEct:CHANnel[:ITEM]:TRACe[:ACTive]..... | 871 |
| MMEMory:SELEct:CHANnel[:ITEM]:TRANSDucer:ALL..... | 871 |
| MMEMory:SELEct[:ITEM]:ALL.....                    | 869 |
| MMEMory:SELEct[:ITEM]:DEFault.....                | 869 |
| MMEMory:SELEct[:ITEM]:HWSettings.....             | 869 |
| MMEMory:SELEct[:ITEM]:LINES:ALL.....              | 870 |
| MMEMory:SELEct[:ITEM]:NONE.....                   | 870 |
| MMEMory:SELEct[:ITEM]:SGRam.....                  | 870 |
| MMEMory:SELEct[:ITEM]:SPECTrogram.....            | 870 |
| MMEMory:SELEct[:ITEM]:TRACe<t>[:ACTive].....      | 871 |
| MMEMory:SELEct[:ITEM]:TRANSDucer:ALL.....         | 871 |
| MMEMory:STORe<n>:LIMit.....                       | 857 |
| MMEMory:STORe<n>:LIST.....                        | 887 |
| MMEMory:STORe<n>:PEAK.....                        | 887 |

|                                                    |     |
|----------------------------------------------------|-----|
| MMEMory:STORe<n>:SGRam.....                        | 887 |
| MMEMory:STORe<n>:SPEctrogram.....                  | 887 |
| MMEMory:STORe<n>:SPURious.....                     | 888 |
| MMEMory:STORe<n>:STATe.....                        | 874 |
| MMEMory:STORe<n>:STATe:NEXT.....                   | 875 |
| MMEMory:STORe<n>:TFACtor.....                      | 898 |
| MMEMory:STORe<n>:TRACe.....                        | 781 |
| MMEMory:STORe<n>:TYPE.....                         | 875 |
| OUTPut:UPORt:WTRigger:POLarity.....                | 755 |
| OUTPut<up>:IF:IFFRequency.....                     | 753 |
| OUTPut<up>:IF[:SOURce].....                        | 753 |
| OUTPut<up>:UPORt:STATe.....                        | 754 |
| OUTPut<up>:UPORt[:VALue].....                      | 754 |
| READ:PMETER<p>?.....                               | 748 |
| SOURce<si>:TEMPerature:FRONTend.....               | 894 |
| STATus:OPERation:CONDition?.....                   | 948 |
| STATus:OPERation:ENABle.....                       | 949 |
| STATus:OPERation:NTRansition.....                  | 950 |
| STATus:OPERation:PTRansition.....                  | 951 |
| STATus:OPERation[:EVENT]?.....                     | 949 |
| STATus:PRESet.....                                 | 948 |
| STATus:QUEStionable:ACPLimit:CONDition?.....       | 948 |
| STATus:QUEStionable:ACPLimit:ENABle.....           | 949 |
| STATus:QUEStionable:ACPLimit:NTRansition.....      | 950 |
| STATus:QUEStionable:ACPLimit:PTRansition.....      | 951 |
| STATus:QUEStionable:ACPLimit[:EVENT]?.....         | 949 |
| STATus:QUEStionable:CONDition?.....                | 948 |
| STATus:QUEStionable:ENABle.....                    | 949 |
| STATus:QUEStionable:EXTended:CONDition?.....       | 948 |
| STATus:QUEStionable:EXTended:ENABle.....           | 949 |
| STATus:QUEStionable:EXTended:INFO:CONDition?.....  | 948 |
| STATus:QUEStionable:EXTended:INFO:ENABle.....      | 949 |
| STATus:QUEStionable:EXTended:INFO:NTRansition..... | 950 |
| STATus:QUEStionable:EXTended:INFO:PTRansition..... | 951 |
| STATus:QUEStionable:EXTended:INFO[:EVENT]?.....    | 949 |
| STATus:QUEStionable:EXTended:NTRansition.....      | 950 |
| STATus:QUEStionable:EXTended:PTRansition.....      | 951 |
| STATus:QUEStionable:EXTended[:EVENT]?.....         | 949 |
| STATus:QUEStionable:FREQuency:CONDition?.....      | 948 |
| STATus:QUEStionable:FREQuency:ENABle.....          | 949 |
| STATus:QUEStionable:FREQuency:NTRansition.....     | 950 |
| STATus:QUEStionable:FREQuency:PTRansition.....     | 951 |
| STATus:QUEStionable:FREQuency[:EVENT]?.....        | 949 |
| STATus:QUEStionable:LIMit<n>:CONDition?.....       | 948 |
| STATus:QUEStionable:LIMit<n>:ENABle.....           | 949 |
| STATus:QUEStionable:LIMit<n>:NTRansition.....      | 950 |
| STATus:QUEStionable:LIMit<n>:PTRansition.....      | 951 |
| STATus:QUEStionable:LIMit<n>[:EVENT]?.....         | 949 |
| STATus:QUEStionable:LMARgin<n>:CONDition?.....     | 948 |
| STATus:QUEStionable:LMARgin<n>:ENABle.....         | 949 |



|                                                                  |     |
|------------------------------------------------------------------|-----|
| STATus:QUESTionable:LMARgin<n>:NTRansition.....                  | 950 |
| STATus:QUESTionable:LMARgin<n>:PTRansition.....                  | 951 |
| STATus:QUESTionable:LMARgin<n>[:EVENT]?                          | 949 |
| STATus:QUESTionable:NTRansition.....                             | 950 |
| STATus:QUESTionable:POWer:CONDition?                             | 948 |
| STATus:QUESTionable:POWer:ENABle.....                            | 949 |
| STATus:QUESTionable:POWer:NTRansition.....                       | 950 |
| STATus:QUESTionable:POWer:PTRansition.....                       | 951 |
| STATus:QUESTionable:POWer[:EVENT]?                               | 949 |
| STATus:QUESTionable:PTRansition.....                             | 951 |
| STATus:QUESTionable:TEMPerature:CONDition?                       | 948 |
| STATus:QUESTionable:TEMPerature:ENABle.....                      | 949 |
| STATus:QUESTionable:TEMPerature:NTRansition.....                 | 950 |
| STATus:QUESTionable:TEMPerature:PTRansition.....                 | 951 |
| STATus:QUESTionable:TEMPerature[:EVENT]?                         | 949 |
| STATus:QUESTionable:TIME:CONDition?                              | 948 |
| STATus:QUESTionable:TIME:ENABle.....                             | 949 |
| STATus:QUESTionable:TIME:NTRansition.....                        | 950 |
| STATus:QUESTionable:TIME:PTRansition.....                        | 951 |
| STATus:QUESTionable:TIME[:EVENT]?                                | 949 |
| STATus:QUESTionable[:EVENT]?                                     | 949 |
| STATus:QUEEue[:NEXT]?                                            | 948 |
| SYSTem:CLOGging.....                                             | 579 |
| SYSTem:COMMunicate:GPIB[:SELF]:ADDResS.....                      | 904 |
| SYSTem:COMMunicate:GPIB[:SELF]:RTERminator.....                  | 904 |
| SYSTem:COMMunicate:PRINter:ENUMerate:FIRSt?                      | 885 |
| SYSTem:COMMunicate:PRINter:ENUMerate[:NEXT]?                     | 885 |
| SYSTem:COMMunicate:PRINter:SELEct<device>.....                   | 886 |
| SYSTem:COMMunicate:RDEvice:PMETer<p>:CONFigure:AUTO[:STATE]..... | 744 |
| SYSTem:COMMunicate:RDEvice:PMETer<p>:COUNT?                      | 745 |
| SYSTem:COMMunicate:RDEvice:PMETer<p>:DEFine.....                 | 745 |
| SYSTem:DISPlay:FPANel[:STATE].....                               | 902 |
| SYSTem:DISPlay:LANGuage.....                                     | 903 |
| SYSTem:DISPlay:LOCK.....                                         | 905 |
| SYSTem:DISPlay:UPDate.....                                       | 905 |
| SYSTem:ERRor:CLEar:ALL.....                                      | 909 |
| SYSTem:ERRor:CLEar:REMote.....                                   | 909 |
| SYSTem:ERRor:DISPlay.....                                        | 906 |
| SYSTem:ERRor:EXTended?.....                                      | 910 |
| SYSTem:ERRor:LIST?.....                                          | 910 |
| SYSTem:ERRor[:NEXT]?                                             | 911 |
| SYSTem:FIRMWare:UPDate.....                                      | 911 |
| SYSTem:FORMat:IDENT.....                                         | 911 |
| SYSTem:HPCoupling.....                                           | 914 |
| SYSTem:IDENtify:FACTory.....                                     | 906 |
| SYSTem:IDENtify[:STRing].....                                    | 906 |
| SYSTem:IFGain:MODE.....                                          | 915 |
| SYSTem:KLOCK.....                                                | 906 |
| SYSTem:LANGuage.....                                             | 906 |
| SYSTem:LANGuage.....                                             | 915 |

|                                               |     |
|-----------------------------------------------|-----|
| SYSTem:LXI:INFO?                              | 907 |
| SYSTem:LXI:LANReset                           | 907 |
| SYSTem:LXI:MDEscription                       | 907 |
| SYSTem:LXI:PASSword                           | 907 |
| SYSTem:PASSword:RESet                         | 914 |
| SYSTem:PASSword[:CENable]                     | 913 |
| SYSTem:PRESet                                 | 875 |
| SYSTem:PRESet:CHANnel[:EXEC]                  | 876 |
| SYSTem:PRESet:COMPAtible                      | 912 |
| SYSTem:PSA:WIDeband                           | 915 |
| SYSTem:REBoot                                 | 579 |
| SYSTem:REVision:FACTory                       | 908 |
| SYSTem:REVision[:STRing]                      | 916 |
| SYSTem:RSweep                                 | 916 |
| SYSTem:SEQuencer                              | 585 |
| SYSTem:SHUTdown                               | 579 |
| SYSTem:SPEaker:VOLume                         | 755 |
| SYSTem:SPEaker[:STATe]                        | 755 |
| TRACe<n>:COPY                                 | 765 |
| TRACe<n>[:DATA]                               | 776 |
| TRACe<n>[:DATA]:MEMory?                       | 778 |
| TRACe<n>[:DATA]:X?                            | 778 |
| TRIGger[:SEQuence]:DTIME                      | 735 |
| TRIGger[:SEQuence]:HOLDoff[:TIME]             | 735 |
| TRIGger[:SEQuence]:IFPower:HOLDoff            | 736 |
| TRIGger[:SEQuence]:IFPower:HYSteresis         | 736 |
| TRIGger[:SEQuence]:LEVel:IFPower              | 737 |
| TRIGger[:SEQuence]:LEVel:IQPower              | 737 |
| TRIGger[:SEQuence]:SLOPe                      | 738 |
| TRIGger[:SEQuence]:SOURce                     | 738 |
| TRIGger[:SEQuence]:TIME:RINTerval             | 739 |
| TRIGger<tp>[:SEQuence]:LEVel[:EXTernal<port>] | 737 |
| UNIT<n>:PMETer<p>:POWer                       | 752 |
| UNIT<n>:PMETer<p>:POWer:RATio                 | 752 |
| UNIT<n>:POWer                                 | 729 |

# Index

## Symbols

- \*OPC ..... 186
  - \*OPC? ..... 186
  - \*RST ..... 204
  - \*WAI ..... 186
  - # of Samples
    - Softkey (APD, CCDF) ..... 352
  - % Power Bandwidth
    - Softkey ..... 291
  - 9.91E37
    - Remote control ..... 184
  - 75 Ω (channel bar) ..... 70
- ## A
- Aborting
    - Sweep ..... 445, 446, 526, 527
  - AC supply fuse ..... 19
  - ACLR
    - Programming example ..... 611
    - Results (remote) ..... 592
    - see CP/ACLR ..... 262
  - ACLR Mode
    - Softkey ..... 272
  - Active
    - Transducer lines ..... 155
  - Adjust settings
    - Softkey (APD) ..... 353, 357
    - Softkey (C/N) ..... 287
  - Adjust Settings
    - Softkey (CP/ACLR) ..... 273
    - Softkey (OBW) ..... 292
  - Adjust X-Axis
    - Softkey ..... 342
  - Alignment
    - Basics ..... 163
    - Performing ..... 166
    - Results ..... 163, 164, 165
    - Settings ..... 164
    - touchscreen ..... 164, 165
    - Touchscreen ..... 164
  - All Functions Off ..... 499
  - Alpha
    - RRC filter (SEM) ..... 317
  - Alphanumeric parameters ..... 78
  - AM modulation
    - Measurement example ..... 252, 253
  - AM modulation depth ..... 382
    - About ..... 382
    - Configuring ..... 383
    - Determining ..... 385
    - Markers ..... 383
    - Markers (remote control) ..... 681
    - Measurement (remote control) ..... 681
    - Programming example ..... 682
    - Results ..... 382
    - Results (remote control) ..... 681
    - Search signals ..... 384
    - Search signals (remote control) ..... 681
  - Amplitude
    - Configuration ..... 429
    - Distribution, white noise ..... 359
    - Optimizing display ..... 434
    - Probability, white noise ..... 359
    - Scaling ..... 433
    - Settings ..... 429
  - Analog Demodulation
    - Application ..... 86
  - Analysis bandwidth ..... 352
    - Statistics ..... 352, 359, 361
  - Analysis BW
    - Softkey (APD, CCDF) ..... 352
  - Annotations
    - Hiding/restoring ..... 134
  - AP (trace information) ..... 71
  - APD ..... 347
    - About ..... 347
    - Activating (remote control) ..... 656
    - Application ..... 348
    - Configuring ..... 351
    - Gate (remote control) ..... 658
    - Gate ranges ..... 353
    - Gated trigger ..... 350, 353
    - Measurement (remote control) ..... 656
    - Measurement example ..... 359
    - Performing ..... 351, 357
    - Results ..... 348
    - Results (remote control) ..... 657
    - Scaling (remote control) ..... 660
    - see also Statistics ..... 347
    - Using gate ranges ..... 357
  - Application cards ..... 11
  - Application notes ..... 11
  - Applications
    - Analog Demodulation ..... 86
    - Available ..... 85
    - I/Q Analyzer ..... 86
    - Noise Figure ..... 86
    - Setting ..... 87
    - Signal and Spectrum Analyzer mode ..... 85
    - Spectrum ..... 86
  - Arranging
    - Windows ..... 97
  - Arrow keys ..... 42
  - ASCII trace export ..... 568
  - Att (channel setting) ..... 69
  - Attenuation
    - Auto ..... 431
    - Impact ..... 428
    - Manual ..... 431
    - Protective (remote) ..... 742
  - Audio demodulation
    - Volume (remote control) ..... 755
  - Audio output
    - Marker demodulation ..... 493
  - Audio Output
    - Programming example ..... 841
  - Audio signals
    - Output (remote) ..... 417, 753
  - Auto adjustment
    - Triggered measurement ..... 719
  - Auto all ..... 462
  - Auto frequency ..... 462

- Auto level
  - Hysteresis ..... 463
  - Reference level ..... 431, 462
  - Softkey ..... 431, 462
- Auto Peak detector ..... 503
- Auto peak search ..... 393
- Auto scaling ..... 433
- Auto settings
  - Meastime Auto ..... 462
  - Meastime Manual ..... 462
- Automatic login mechanism
  - Activating/Deactivating ..... 226
- Aux. Port
  - Connector ..... 46
- AV (trace information) ..... 71
- Average count ..... 439, 444, 512
  - Power sensor ..... 415
- Average detector ..... 503
  - EMI ..... 389
- Average mode
  - Traces ..... 512
- Averaging
  - Continuous sweep ..... 507
  - Single sweep ..... 507
  - Sweep count ..... 507
  - Traces ..... 508
  - Traces (algorithm) ..... 507
  - Traces (remote control) ..... 764
- B**
- Band power markers
  - Programming example ..... 839
- Band power measurement
  - Activating/Deactivating ..... 492
  - Deactivating ..... 493
  - Power mode ..... 493
  - Span ..... 493
- Band power measurement (remote control) ..... 822
- Bandwidth
  - Configuration (Softkey) ..... 440
  - Coupling ..... 436, 437
  - CP/ACLR ..... 274
  - Default settings ..... 434
  - Resolution ..... 401, 435, 441
  - Video ..... 436, 442
- Basic Measurement Examples
  - see User Manual ..... 7
- Block data ..... 182
- Boolean parameters ..... 181
- Brackets ..... 182
- Brochures ..... 11
- Burst signals
  - Measurement example ..... 255
- C**
- C/N, C/N0
  - see Carrier-to-Noise ..... 284
- Calibration
  - Frequency ..... 150
  - Frequency RF ..... 150
  - Remote ..... 575
  - Remote control ..... 891
  - Results (remote control) ..... 892
  - RF ..... 150
  - Settings ..... 150
  - Signal ..... 150
  - Signal, as RF input ..... 48
- Calibration certificate ..... 12
- Calibration Frequency MW ..... 893
- Capture time
  - see also Measurement time ..... 726, 728
- Carrier Noise Config
  - Softkey ..... 286
- Carrier-to-Noise ..... 284
  - Activating ..... 287
  - Channel bandwidth ..... 287
  - Channel bandwidth (remote control) ..... 613
  - Configuring ..... 286
  - Determining ..... 288
  - Measurement ..... 284
  - Measurement (remote control) ..... 613
  - Measurement process ..... 285
  - Results ..... 285
  - Results (remote control) ..... 613
  - Span ..... 285
- Case-sensitivity
  - SCPI ..... 178
- CCDF ..... 347
  - About ..... 347
  - Activating (remote control) ..... 656
  - Application ..... 348
  - Configuring ..... 351
  - Crest factor ..... 349
  - Gate (remote control) ..... 658
  - Gate ranges ..... 353
  - Gated trigger ..... 350, 353
  - Measurement (remote control) ..... 656
  - Measurement example ..... 359
  - Percent marker ..... 350, 352
  - Percent marker (remote control) ..... 657
  - Performing ..... 351, 357
  - Results ..... 349
  - Results (remote control) ..... 657
  - Scaling (remote control) ..... 660
  - see also Statistics ..... 347
  - Using gate ranges ..... 357
- Center = Mkr Freq ..... 479
- Center frequency ..... 422
  - Automatic configuration ..... 462
  - Setting to marker ..... 479
  - Softkey ..... 422
  - Step size ..... 419, 423, 425
  - Sub blocks (Multi-SEM) ..... 315
- Centroid frequency
  - OBW measurement ..... 290
- Channel bandwidth
  - C/N ..... 287
  - CP/ACLR ..... 274
- Channel Bandwidth
  - OBW ..... 292
  - Softkey ..... 292
- Channel bar
  - Changing names ..... 70
  - Information ..... 67
- Channel power
  - Comparing (CP/ACLR) ..... 279
  - Density (CP/ACLR) ..... 272
  - SEM results ..... 295
  - Settings (SEM) ..... 316
- Channel settings
  - Display ..... 67, 69

- Channel Setup
  - Creating (remote) ..... 581, 583
  - Deleting (remote) ..... 581
  - Duplicating (remote) ..... 580
  - Querying (remote) ..... 581
  - Renaming (remote) ..... 582
  - Replacing (remote) ..... 581
  - Selecting (remote) ..... 583
- Channel Setup bar
  - Hiding/restoring ..... 134
- channel setup settings
  - Presetting ..... 102
- Channel Setups
  - Duplicating ..... 89
  - New ..... 89
  - Replacing ..... 89
  - Sequential operation ..... 89
- Channel-defined Sequencer
  - Softkey ..... 92
- Channels
  - CP/ACLR ..... 274, 277
  - CP/ACLR measurements ..... 271
  - Names (CP/ACLR) ..... 276
  - Spacings (CP/ACLR) ..... 275
  - Spacings, configuring ..... 278
  - Switching ..... 67
  - Trying out ..... 52
  - Weighting filters ..... 276
- CISPR Average
  - Detector ..... 388
- CISPR Average detector
  - EMI ..... 390
- CISPR bandwidth ..... 388, 402
- Cleaning ..... 961
- Clear status
  - Remote ..... 575
- Closing
  - Channel Setups (remote) ..... 581
  - Windows ..... 97
  - Windows (remote) ..... 708
- CLRW (trace information) ..... 71
- CMT
  - Display ..... 369
- CNT (marker functions) ..... 72
- Colon ..... 182
- Color curve
  - Shape ..... 522, 528
  - Spectrograms ..... 522, 532
- Color mapping
  - Color curve ..... 528
  - Color range ..... 528, 529
  - Color scheme ..... 529
  - Softkey ..... 526
  - Spectrograms ..... 521, 526, 527, 531
  - Step by step ..... 531
  - Value range ..... 522
- Color scheme
  - Spectrogram ..... 521, 529
- Colors
  - Configuring ..... 139
  - Display ..... 136
  - Editing ..... 136
  - Editing (remote) ..... 902
  - Print ..... 137
  - Printing ..... 136
- Comma ..... 182
- Command sequence
  - Recommendation ..... 204
  - Remote ..... 578
- Commands ..... 176
  - Brackets ..... 182
  - Colon ..... 182
  - Comma ..... 182
  - Command line structure ..... 183
  - Common ..... 176
  - Double dagger ..... 182
  - GBIP, addressed ..... 175
  - GBIP, universal ..... 175
  - Instrument control ..... 176
  - Overlapping ..... 185
  - Question mark ..... 182
  - Quotation mark ..... 182
  - SCPI confirmed ..... 176
  - Sequential ..... 185
  - Syntax elements ..... 182
  - Tracking ..... 210
  - Vertical stroke ..... 182
  - White space ..... 182
- Comment
  - Gate ranges (statistics) ..... 354
  - Limit lines ..... 546
  - Screenshots ..... 118
  - Softkey ..... 118
  - Transducer lines ..... 157
- Common commands
  - Syntax ..... 177
- Compatibility
  - FSQ, FSP, FSU, FSV ..... 212
  - GPIB ..... 211
  - Limit lines ..... 538, 544
  - Mode ..... 212
  - Transducer lines ..... 155
- Compatible mode (channel setting) ..... 69
- Computer name ..... 207
- Changing ..... 34
- CONDition ..... 189
- Connector
  - AC power supply ..... 44
  - Aux. Port ..... 46
  - Display Port ..... 45
  - DVI ..... 45
  - GPIB interface ..... 44
  - Headphones ..... 47
  - IF/VIDEO/DEMODO ..... 47
  - LAN ..... 45
  - Noise source control ..... 47
  - Power Sensor ..... 46
  - Ref. In ..... 45
  - Ref. Out ..... 45
  - RF Input 50Ω ..... 42
  - Trigger In ..... 45
  - USB ..... 39, 45
- Context menus ..... 75
- Continue single sweep
  - Softkey ..... 241, 446
- Continuous Sequencer
  - Softkey ..... 92
- Continuous sweep
  - Softkey ..... 241, 446, 526
- Conventions
  - SCPI commands ..... 573

|                                      |               |  |
|--------------------------------------|---------------|--|
| Copying                              |               |  |
| Channel Setup (remote)               | 580           |  |
| Traces                               | 513           |  |
| Coupling                             |               |  |
| GPIO                                 | 213           |  |
| GPIO (remote control)                | 914           |  |
| Span/RBW                             | 437           |  |
| VBW/RBW                              | 436           |  |
| Coupling ratio                       |               |  |
| Span/RBW (remote)                    | 723           |  |
| Coupling ratios                      |               |  |
| Default                              | 444           |  |
| RBW/VBW                              | 443           |  |
| Span/RBW                             | 443           |  |
| CP/ACLR                              | 262           |  |
| About                                | 262           |  |
| Absolute/relative values             | 272           |  |
| Adjust Settings                      | 273           |  |
| Channel bandwidths                   | 274           |  |
| Channel bandwidths (remote control)  | 597           |  |
| Channel names                        | 276           |  |
| Channel names (remote control)       | 597           |  |
| Channel power density                | 272           |  |
| Channel setup                        | 274           |  |
| Channel setup (remote control)       | 597           |  |
| Channel spacing                      | 278           |  |
| Channel spacing (remote control)     | 597           |  |
| Channel spacings                     | 275           |  |
| Clear/Write                          | 273           |  |
| Comparing channel powers             | 279           |  |
| Configuring                          | 269           |  |
| Detector                             | 268           |  |
| Fixed reference for CP               | 273           |  |
| Frequency span                       | 266           |  |
| General Settings                     | 269           |  |
| Limit check                          | 275           |  |
| Limit check (remote control)         | 604           |  |
| Max Hold                             | 273           |  |
| Measurement (remote control)         | 595           |  |
| Measurement examples                 | 280           |  |
| Mode                                 | 272           |  |
| Number of channels                   | 271           |  |
| Number of channels (remote control)  | 597           |  |
| Optimizing                           | 283           |  |
| Performing                           | 269           |  |
| Performing measurement               | 277           |  |
| Power mode                           | 273           |  |
| Power Unit                           | 272           |  |
| Predefined Settings                  | 270           |  |
| Predefined standards                 | 284           |  |
| RBW                                  | 267           |  |
| Reference channel                    | 272           |  |
| Reference channel (remote control)   | 603           |  |
| Reference level                      | 268           |  |
| Results                              | 263, 609      |  |
| Setting up channels                  | 277           |  |
| Setting up channels (remote control) | 597           |  |
| Standards                            | 270           |  |
| Standards (remote control)           | 596           |  |
| Standards (Softkey)                  | 270           |  |
| Sweep Time                           | 265, 273      |  |
| Trace averaging                      | 268           |  |
| Trace Selection                      | 272           |  |
| Troubleshooting                      | 283           |  |
| User-defined standards               | 270, 279      |  |
| VBW                                  | 267           |  |
| Weighting filters                    | 276           |  |
| Weighting filters (remote control)   | 601           |  |
| Crest factor                         |               |  |
| APD                                  | 349           |  |
| CCDF                                 | 349           |  |
| Cumulated Measurement Time (CMT)     |               |  |
| Harmonics                            | 369           |  |
| CXA/EXA emulation                    | 944           |  |
| <b>D</b>                             |               |  |
| Data format                          |               |  |
| ASCII                                | 779           |  |
| Binary                               | 779           |  |
| Remote                               | 780, 886      |  |
| Data sheets                          | 11            |  |
| Date                                 |               |  |
| Format                               | 132           |  |
| Hiding/restoring                     | 134           |  |
| Instrument setting                   | 132           |  |
| Setting                              | 36            |  |
| Date and Time                        |               |  |
| Printing                             | 119           |  |
| DCL                                  | 175           |  |
| Debugging                            |               |  |
| Remote control programs              | 966           |  |
| Decimal separator                    |               |  |
| Trace export                         | 115, 564, 566 |  |
| DEF                                  | 180           |  |
| Default                              |               |  |
| Restoring settings                   | 102           |  |
| Default coupling                     | 444           |  |
| Default values                       |               |  |
| Remote                               | 577           |  |
| Deleting                             |               |  |
| Limit line values                    | 548           |  |
| Settings files                       | 320           |  |
| Standards                            | 320           |  |
| Transducer factors                   | 158           |  |
| Delta markers                        | 397, 468      |  |
| Defining                             | 397, 468, 484 |  |
| Fixed reference marker               | 500           |  |
| Remote control                       | 784           |  |
| Demodulation                         |               |  |
| Activating (marker)                  | 494           |  |
| Continuous (marker)                  | 495           |  |
| Marker                               | 493           |  |
| Marker stop time                     | 495           |  |
| Modulation type                      | 495           |  |
| Remote control                       | 831           |  |
| Demodulation markers                 |               |  |
| Programming example                  | 841           |  |
| Detectors                            |               |  |
| CP/ACLR                              | 268           |  |
| EMI                                  | 388           |  |
| Overview                             | 503           |  |
| Remote control                       | 764           |  |
| Spurious Emissions range             | 341           |  |
| Trace                                | 398, 511      |  |
| Device ID                            | 148, 149      |  |
| Device-specific commands             | 176           |  |
| DHCP                                 | 32, 208, 219  |  |
| DHCP server                          |               |  |
| LAN configuration                    | 34            |  |

- Diagram area
  - Channel settings ..... 69
  - Status display ..... 72
  - Trace information ..... 71
- Diagram footer ..... 72
  - Hiding/restoring ..... 134
- Diagrams
  - Evaluation method ..... 260
- Dialog boxes
  - Slider ..... 77
  - Transparency ..... 77
- Dialogs
  - Printing ..... 118
  - Suppressing file selection ..... 122
- Dirty flag
  - see Invalid data icon ..... 68
- Display
  - Colors ..... 136, 139
  - Config (Softkey) ..... 94
  - Evaluation bar ..... 97
  - Evaluation methods ..... 94
  - Information ..... 66
  - Settings ..... 131
  - Settings (remote control) ..... 899
  - SmartGrid ..... 94
  - Theme ..... 136
  - Theme (remote) ..... 902
  - Update (remote) ..... 210
  - Update rate ..... 132
- Display lines ..... 536
  - Defining ..... 537
  - Remote control ..... 843
  - Settings ..... 536
- Display Port
  - Connector ..... 45
- Displayed items
  - Touchscreen ..... 132
- DNS server
  - IP Address ..... 221
  - LAN configuration ..... 34
- Double dagger ..... 182
- DOWN ..... 180
- Drop-out time
  - Trigger ..... 451, 456
- Duplicating
  - Channel Setup (remote) ..... 580
- Duty cycle
  - Power sensor ..... 415
- DVI
  - Connector ..... 45
- Dwell time ..... 394, 401
  - EMI detectors ..... 388
- Dynamic range
  - Intermodulation-free ..... 376
  - Measuring ..... 367
- E**
- Edge gate
  - Slope ..... 457
- Electromagnetic compatibility
  - see EMC ..... 385
- Electromagnetic interference
  - see EMI ..... 385
- Electronic input attenuation ..... 431
- Electrostatic discharge ..... 14
- EMC ..... 385
- EMI ..... 385
  - Detectors ..... 388
  - Measurement ..... 386
  - Refining results ..... 394
- EMI marker evaluation ..... 394
- EMI measurement
  - Programming example ..... 689
- ENABLE ..... 189
- Enable registers
  - Remote ..... 577
- Entering data ..... 77
- EOI
  - GPIB terminator ..... 210
- Error log ..... 968
- Error messages
  - Status bar ..... 73, 963
- Error queue ..... 191
- Errors
  - IF OVLD ..... 74, 199, 429, 963
  - Increase sweep points (EMI) ..... 409
  - INPUT OVLD ..... 74, 199, 963
  - LOUNL ..... 964
  - Messages, device-specific ..... 964
  - NO REF ..... 74, 964
  - OVEN ..... 74
  - Queues, recommendations ..... 204
  - Remote control programming ..... 204
  - RF OVLD ..... 74, 199, 964
  - UNCAL ..... 74, 964
  - UNLD ..... 199
  - WRONG\_FW ..... 74, 145, 163, 964
- ESD ..... 14
- ESE (event status enable register ) ..... 192
- ESR (event status register) ..... 192
- Evaluation
  - Lists (SEM) ..... 320
  - Lists (Spurious) ..... 343
  - Modes ..... 94
  - Modes, adding ..... 97
  - Trying out ..... 50
- Evaluation bar
  - Using ..... 97
- Evaluation list
  - Details (Spurious Emissions) ..... 344
  - Peaks (Spurious Emissions) ..... 344
  - Spurious Emissions ..... 336
- Evaluation methods
  - Remote ..... 703
- EVENT ..... 189
- Event status enable register (ESE) ..... 192
  - Remote ..... 575
- Event status register (ESR) ..... 188, 192
  - Remote ..... 575
- Exclude LO ..... 473, 476
  - Remote ..... 792
- Export format
  - SEM results ..... 333
  - Spurious Emissions results ..... 346
  - Traces ..... 568
- Exporting
  - Data ..... 115
  - Functions ..... 107
  - I/Q data ..... 115
  - Measurement settings ..... 564
  - Peak list ..... 499, 567
  - SEM result files ..... 325
  - Softkey ..... 114

- Spurious Emissions result files ..... 345
- Trace data ..... 567
- Traces ..... 114, 115, 563, 564
- EXREF (status display) ..... 74, 964
- EXT REF
  - Status message ..... 73
- External monitor
  - Connectors ..... 45
- External reference
  - Settings (remote control) ..... 890
  - Status message ..... 73
- External trigger ..... 455
  - Level (remote) ..... 737
- F**
- Fast SEM ..... 303
  - Consequences ..... 304
  - Example ..... 304
  - Multi-SEM ..... 303, 305
  - Prerequisites ..... 303
  - SEM ..... 310
- FFT filters
  - Mode ..... 445
- FFT sweep ..... 437
- File format
  - Export Files ..... 568
  - SEM export files ..... 333
  - SEM settings files ..... 328
  - Spurious Emissions export files ..... 346
  - Trace export ..... 568
- File type
  - Storage settings ..... 108
- filename
  - Data files ..... 107
  - Settings ..... 108, 111, 319
- Filter type (EMI) ..... 388, 402
- Filter types ..... 400, 438, 443
  - SEM range ..... 310
  - Spurious Emissions range ..... 340
- Filters
  - Channel ..... 439
  - Configuration ..... 440
  - FFT ..... 445
  - Gaussian (3dB) ..... 438
  - Overview ..... 448
  - RBW ..... 435
  - VBW ..... 436
  - Weighting (remote) ..... 601
- Final test ..... 394
- Firmware
  - Updating ..... 145
- Firmware Update
  - Remote control ..... 911
- Fixed reference
  - Configuring ..... 500
  - Defining ..... 471, 489
  - Delta markers ..... 500
  - Remote control ..... 812
- Format
  - Data ..... 779
  - Data (remote) ..... 780, 886
  - Date and time ..... 132
  - see also File format ..... 568
- Frame count
  - Softkey ..... 447
  - Spectrograms ..... 517
- Frames
  - Spectrogram marker ..... 468
- Free Run
  - Trigger ..... 454
- Frequencies
  - Multi-SEM ..... 305
- Frequency
  - Configuration (Softkey) ..... 420
  - Coupling (power sensor) ..... 413
  - IF Out ..... 417
  - Offset ..... 424
  - Power sensor ..... 413
  - Range ..... 418
  - Range, defining ..... 425
  - Reference (remote control) ..... 890
  - Span ..... 422
  - Start ..... 422
  - Step size ..... 419
  - Stop ..... 422
- Frequency axis
  - Scaling ..... 401, 419
- Frequency lines
  - Remote control ..... 843
- Frequency span
  - CP/ACLR ..... 266
- Frequency sweep
  - Measurement ..... 240
  - Programming example ..... 700
- Front panel
  - Hiding/restoring ..... 135
- Frontend
  - Temperature ..... 163
  - Temperature (remote) ..... 894
  - Temperature, status bit ..... 199
- Frq (channel bar) ..... 70
- Full span
  - Softkey ..... 422
- Function keys
  - Details - see User Manual ..... 40
  - Overview ..... 40
- Fuse ..... 19
- FXD (marker functions) ..... 72
- G**
- GAT (channel bar) ..... 70
- Gate
  - Delay ..... 460
  - Length ..... 460
  - Measurements ..... 458
  - Mode ..... 459
  - Ranges (statistics) ..... 350
  - Settings ..... 459
- Gate ranges
  - Activating (statistics) ..... 354
  - Comment (statistics) ..... 354
  - Period (statistics) ..... 354
  - Start/Stop (statistics) ..... 354
  - Statistics ..... 353
- Gated trigger
  - Activating ..... 459
  - Configuring (statistics) ..... 353, 357
  - Delay ..... 460
  - Example ..... 358
  - Length ..... 460
  - Mode ..... 459



- Softkey ..... 353
- Statistics ..... 350, 353, 361
- Gating
  - Source ..... 454
- GET ..... 175
- Getting started ..... 10
- GPIB ..... 168
  - Address ..... 209, 224
  - Characteristics ..... 173
  - Coupling ..... 213
  - IF Gain (remote control) ..... 915
  - interface messages ..... 173
  - Language ..... 212
  - Language (remote control) ..... 915
  - Settings ..... 208
  - Terminator ..... 210
- GPIB bus control
  - Remote ..... 576
- GPIB interface
  - Configuring - see User Manual ..... 44
  - Connector ..... 44
  - Remote control ..... 84
- GPIB Language ..... 204
- Graphical zoom ..... 80
- Group delay
  - Smoothing ..... 512
- GTL ..... 175
- H**
- Hardcopy
  - see Screenshots ..... 65
- Hardware
  - Check ..... 145
  - Information ..... 142
  - Supported ..... 145
- Harmonic Distortion ..... 366
  - About ..... 366
  - Activating (remote control) ..... 675
  - Basics ..... 367
  - Configuring ..... 370
  - Measurement (remote control) ..... 675
  - Measuring ..... 372
  - RBW ..... 371
  - Results ..... 369
  - Results (remote control) ..... 675
  - Sweep time ..... 371
- Harmonics
  - Basics ..... 367
  - High-sensitivity ..... 369
  - Measurement example ..... 501
  - Measurement rules ..... 368
  - Measurement time ..... 369
  - Number ..... 371
  - Origin ..... 369
  - Power ..... 370
  - Second harmonic intercept ..... 367
- Headphones
  - Connector ..... 47
- Help ..... 81
  - Search for topic ..... 82
  - Using ..... 82
- Hiding/restoring
  - Display items ..... 132
- Highpass filter
  - LISN control (EMI) ..... 403
- HiSLIP ..... 169
  - Protocol ..... 170
  - Resource string ..... 169
- History
  - Spectrograms ..... 526
- History Depth
  - Softkey ..... 526
- Hold
  - Trace setting ..... 511
- Horizontal Line 1/2
  - Softkeys ..... 537
- HP emulation ..... 916
- Hysteresis
  - Lower (Auto level) ..... 463
  - Trigger ..... 456
  - Upper (Auto level) ..... 463
- I**
- I/O Logging ..... 210
- I/Q Analyzer
  - Application ..... 86
  - Trying out ..... 52
- I/Q data
  - Exporting ..... 115
- I/Q Power
  - Trigger level (remote) ..... 737
- ID String User ..... 204
- Identification
  - Remote ..... 576
  - String, R&S FPL1000 ..... 209
  - String, resetting (R&S FPL1000) ..... 209
- IEC/IEEE bus
  - see GPIB ..... 168
- IECWIN
  - Accessing ..... 26
- IF frequency
  - Output ..... 417
  - Output (remote) ..... 753
- IF Gain
  - GPIB ..... 212
  - GPIB (remote control) ..... 915
- IF Out Frequency ..... 417
- IF output ..... 417
  - Remote ..... 753
- IF OVLD
  - Error ..... 74, 963
- IF OVLD (status display) ..... 74, 963
- IF Power
  - Trigger ..... 455
  - Trigger level (remote) ..... 737
- IF/VIDEO/DEMOD
  - Connector ..... 47
- IFC ..... 175
- Impedance
  - Setting ..... 410, 431
- Importing
  - Functions ..... 107
  - Softkey ..... 113
- INF ..... 180
- Information
  - Hardware ..... 142
  - Options ..... 142
  - Version ..... 142

- Input
  - Overload (remote) ..... 742
  - RF ..... 410
  - Signal, parameters ..... 409
- INPUT OVLD
  - Error ..... 74, 963
- INPUT OVLD (status display) ..... 74, 963
- Inserting
  - Limit line values ..... 548
  - Transducer factors ..... 158
- Installing
  - Options ..... 144
- Instrument messages ..... 176
- Instrument name
  - Changing ..... 221
- Instrument security procedures ..... 11
- Interface messages ..... 176
- Interfaces
  - GPIB ..... 173
  - LAN ..... 168
- Intermodulation products ..... 373
- Interrupt ..... 200
- Invalid data
  - Icon ..... 68
- Invalid results
  - Remote control ..... 184
- IP address ..... 169
  - Assigning ..... 219
  - Changing ..... 32
  - Network ..... 208
- IP Address
  - DNS server ..... 221
- IP configuration
  - LXI ..... 223
- IST ..... 188
- IST flag ..... 192
  - Remote ..... 576
- Items
  - Saving ..... 106
  - Settings ..... 108
- K**
- Key
  - DOWN ..... 42
  - LEFT ..... 42
  - Power ..... 39
  - RIGHT ..... 42
  - UP ..... 42
- Keyboard
  - On-screen ..... 76
- Keypad
  - Overview ..... 41
- Keys
  - MKR ..... 466
  - MKR -> ..... 472, 478
  - MKR FUNCT ..... 479
  - Peak Search ..... 478
  - PRESET ..... 102
  - RUN CONT ..... 241, 446, 526
  - RUN SINGLE ..... 241, 445, 446, 527
- Keywords
  - see Mnemonics ..... 177
- L**
- LAN
  - Configuration ..... 30
  - Configuring ..... 222
  - Connector ..... 45
  - Interface ..... 168
  - IP address ..... 169
  - Remote control interface ..... 168
  - Reset ..... 215
  - VISA ..... 169
  - VXI protocol ..... 170
- Language
  - Selecting ..... 35
  - User interface ..... 35
- Last span
  - Softkey ..... 423
- LFEOL
  - GPIB terminator ..... 210
- Limit check
  - Activating/Deactivating ..... 549
  - CP/ACLR ..... 275
  - Remote control ..... 845
  - Results ..... 540
  - SEM range ..... 312
  - Spurious Emissions ..... 338
  - Spurious Emissions range ..... 342
- Limit lines ..... 404, 538, 542
  - Activating/Deactivating ..... 544
  - Calculation (Multi-SEM) ..... 305, 306, 313
  - Comment ..... 546
  - Compatibility ..... 538, 544
  - Compatible ..... 549
  - Copying ..... 545, 550
  - Creating ..... 545, 550
  - Data points ..... 547
  - Deactivating ..... 545
  - Defining ..... 549
  - Deleting ..... 545, 550
  - Deleting values ..... 548
  - Details ..... 545
  - Editing ..... 545, 550
  - Inserting values ..... 548
  - Managing ..... 542
  - Margin ..... 547
  - Margins ..... 539
  - Name ..... 546
  - OBW ..... 292, 474, 477
  - Offsets ..... 540
  - Peak search ..... 292, 474, 477
  - Recalling ..... 104
  - Remote control ..... 845
  - Saving ..... 104, 106, 548
  - Selecting ..... 544
  - SEM ..... 301, 549
  - Shifting ..... 540, 548, 551
  - Spurious ..... 549
  - Spurious Emissions ..... 337
  - Storing ..... 542
  - Threshold ..... 539, 546
  - Time Domain Power measurement ..... 362
  - Traces ..... 544
  - View filter ..... 544
  - Violation ..... 540
  - Visibility ..... 544
  - X-axis ..... 547
  - X-Offset ..... 544

- Y-axis ..... 547
- Y-Offset ..... 545
- Limits
  - Absolute (SEM range) ..... 312
  - Absolute (Spurious Emissions range) ..... 342
  - Relative (SEM range) ..... 312
- Line impedance stabilization network
  - see LISN ..... 392
- Linear scaling
  - X-axis ..... 401, 419
- Lines
  - Configuration ..... 542
  - Display ..... 536, 537
  - Horizontal ..... 537
  - Limit, see Limit lines ..... 542
  - Vertical ..... 537
- Linking
  - Markers ..... 397, 469
- LISN ..... 403
  - Configuration (EMI) ..... 402
  - EMI ..... 392
  - Highpass filter (EMI) ..... 403
  - Phase (EMI) ..... 403
- List evaluation ..... 691
  - Evaluations ..... 320, 343
  - Saving (SEM) ..... 322
  - Saving (Spurious Emissions) ..... 344
  - SEM ..... 320
  - Softkey ..... 320
  - Spurious Emissions ..... 343
  - State (SEM) ..... 321
  - State (Spurious Emissions) ..... 343
- LLO ..... 175
- Loading
  - Functions ..... 107
  - Instrument settings ..... 111
  - Settings ..... 102, 104
  - Settings files ..... 320
  - Trying out ..... 64
- Logarithmic scaling
  - Sweep points ..... 419
  - X-axis ..... 401, 419
- Login
  - Network ..... 225
  - Operating system ..... 24
- Logo
  - Printing ..... 118
- LOUNL
  - Error ..... 964
- LOUNL (status display) ..... 964
- Lower Level Hysteresis ..... 463
- LXI
  - Browser interface ..... 222
  - Configuration ..... 214
  - LAN configuration ..... 223
  - Manufacturer Description ..... 215
  - Password ..... 214
  - Ping ..... 224
  - Remote control ..... 83, 171
  - Reset (LCI) ..... 215
  - Settings ..... 213
- M**
- Maintenance ..... 961
- Manual peak search ..... 393
- Margins
  - Limit lines ..... 539, 547
  - Peaks (SEM) ..... 321
  - Peaks (Spurious Emissions) ..... 344
  - Violation ..... 540
- Marker
  - Information ..... 71
  - Search area (softkey) ..... 476
  - Search type (softkey) ..... 476
- Marker demodulation ..... 404
- Marker functions
  - Deactivating ..... 499
  - Measurement example ..... 501
- Marker peak list
  - see Peak list ..... 498
- Marker Peak List
  - Programming example ..... 837
- Marker search
  - Spectrograms, programming example ..... 836
- Marker search area
  - Remote control ..... 791
- Marker table
  - Evaluation method ..... 260
  - Information ..... 71
- Marker to Trace ..... 398, 469
- Markers ..... 465
  - AM Modulation Depth measurement ..... 383
  - Analyzing in detail ..... 500
  - Assigned trace ..... 398, 469
  - Band power (remote control) ..... 822
  - Basic settings ..... 467
  - Configuration ..... 467, 470
  - Configuration (remote control) ..... 784
  - Deactivating ..... 470
  - Delta markers ..... 397, 468, 484
  - Demodulation ..... 493
  - Demodulation (remote control) ..... 831
  - Fixed reference (remote control) ..... 790, 812
  - Function configuration ..... 479
  - Linking ..... 397, 469
  - Minimum ..... 479
  - Minimum (remote control) ..... 791, 795
  - n dB down ..... 489
  - n dB down (remote control) ..... 826
  - Next minimum ..... 479
  - Next minimum (remote control) ..... 791, 795
  - Next peak ..... 478
  - Next peak (remote control) ..... 791, 795
  - Noise measurement ..... 482
  - Noise measurement (remote control) ..... 818
  - Peak ..... 478
  - Peak (remote control) ..... 791, 795
  - Peak list (remote control) ..... 814
  - Phase noise measurement ..... 484
  - Phase noise measurement (remote control) ..... 819
  - Position ..... 397, 468
  - Positioning ..... 478
  - Positioning (remote control) ..... 784
  - Programming example ..... 834
  - Remote control ..... 784
  - Search (remote control) ..... 791
  - Setting center frequency ..... 479
  - Setting reference level ..... 479
  - Signal count ..... 481
  - Signal count (remote control) ..... 829
  - Softkeys (AM Modulation Depth) ..... 383
  - Softkeys (TOI) ..... 378

- Spectrograms ..... 518, 530
- Spectrograms (remote control) ..... 803
- State ..... 397, 468, 484
- Step size ..... 471
- Step size (remote control) ..... 790
- Table ..... 470
- Table (evaluation method) ..... 260
- Table (remote control) ..... 790
- Tips ..... 464
- TOI measurement ..... 378
- Trying out ..... 57
- Type ..... 397, 468, 484
- X-value ..... 397, 468
- Mask monitoring
  - SEM ..... 295
- MAX ..... 180
- MAXH (trace information) ..... 71
- Measurement examples
  - AF of AM-modulated signal ..... 253
  - AM modulation ..... 252
  - CP/ACLR ..... 280
  - Harmonics ..... 501
  - Intermodulation ..... 379
  - Level and frequency ..... 242
  - Marker functions ..... 501
  - OBW ..... 294
  - Power of burst signals ..... 255
  - Separating signals ..... 248
  - Signal frequency using signal counter ..... 244
  - Signal-to-noise ratio ..... 258
  - Statistics ..... 359
  - Time Domain Power ..... 365
  - TOI ..... 379
- Measurement results
  - SEM ..... 320
  - Spurious Emissions ..... 343
- Measurement time ..... 401
  - Auto settings ..... 462
  - Power sensor ..... 414
  - Remote ..... 726, 728
- Measurement zoom ..... 80
- Measurements
  - All Functions off ..... 241
  - APD ..... 347
  - Carrier-to-Noise ..... 284
  - CCDF ..... 347
  - CP/ACLR ..... 262
  - Evaluation methods ..... 94
  - Frequency sweep ..... 240
  - Harmonic Distortion ..... 366
  - OBW ..... 288
  - SEM ..... 294
  - Spurious Emissions ..... 335
  - Statistics ..... 347
  - Time Domain Power ..... 361
  - TOI ..... 372
  - Zero span ..... 240
- Measurementsition time
  - Statistics ..... 352
- Menus
  - Context-sensitive ..... 75
- Messages
  - Commands ..... 176
  - Instrument ..... 176
  - Instrument responses ..... 177
  - Interface ..... 176
- MI (trace information) ..... 71
- MIL Std bandwidth ..... 388, 402
- MIN ..... 180
- MINH (trace information) ..... 71
- Mini front panel
  - Hiding/restoring ..... 135
  - Key combination ..... 136
  - Using ..... 141
- Minimum ..... 479
  - Marker positioning ..... 479
  - Next ..... 479
- MKR
  - Key ..... 466
- MKR ->
  - Key ..... 472, 478
- MKR FUNCT
  - Key ..... 479
- Mnemonics ..... 177
  - Optional ..... 179
- MOD (marker functions) ..... 72
- Mode (channel setting) ..... 69
- Modulation
  - Marker Demodulation ..... 495
- Monitor
  - External ..... 138
  - Settings ..... 138
- MSR ACLR
  - Results (remote) ..... 592
- Multi-SEM
  - Basics ..... 304
  - Center frequencies ..... 315
  - Fast SEM ..... 303, 305
  - Frequency definition ..... 305
  - Limit line calculation ..... 305, 306, 313
  - Number of sub blocks ..... 315
  - Results ..... 297
  - Settings ..... 314
  - Standard files ..... 319
- Multiple signals
  - Measurement example ..... 248
- Multiple zoom ..... 554, 556
- MultiView
  - Status display ..... 72
  - Tab ..... 86, 89
  - Trying out ..... 55
- N**
- n dB down
  - Delta value ..... 489
  - Marker ..... 489
  - Remote control ..... 826
- n dB down markers
  - Programming example ..... 840
- Name
  - CP/ACLR channels ..... 276
  - Limit lines ..... 546
  - Transducer lines ..... 157
- NAN ..... 180
- NAN (not a number)
  - Remote control ..... 184
- Navigation
  - Controls ..... 42
  - in tables ..... 42
  - Navigation keys ..... 42
- NCor (enhancement label) ..... 70
- Negative peak detector
  - EMI ..... 389

- Negative Peak detector ..... 503
- Network
  - Automatic login ..... 226
  - Changing user passwords ..... 226
  - Configuration (dialog box) ..... 208
  - Configuring ..... 167, 218
  - Connecting the instrument ..... 219
  - Creating users ..... 225
  - DNS server ..... 221
  - Login ..... 225
  - Operating the instrument ..... 224
  - Setting up ..... 218
  - Settings ..... 206
  - Settings (remote) ..... 904
  - Sharing directories ..... 227
- Next Minimum ..... 479
  - Marker positioning ..... 479
- Next Mode X
  - Softkey ..... 475
- Next Mode Y
  - Softkey ..... 475
- Next Peak ..... 478
  - Marker positioning ..... 478
- NINF ..... 180
- NO REF
  - Error ..... 74, 964
- NOI (marker functions) ..... 72
- Noise
  - Floor (RF attenuation) ..... 428
  - Saving settings ..... 106
  - Source ..... 418
- Noise Figure
  - Application ..... 86
- Noise markers
  - Programming example ..... 838
- Noise measurement
  - Activating/Deactivating ..... 484
  - Deactivating ..... 484
  - Marker ..... 482
  - Remote control ..... 818
- Noise source control
  - Connector ..... 47
- NTRansition ..... 189
- Number of Readings
  - Power sensor ..... 415
- Numeric parameters ..... 77, 180
- Numeric values
  - Special ..... 180
- O**
- OBW ..... 288
  - % Power (remote control) ..... 614
  - % Power Bandwidth ..... 291
  - Adjust Settings ..... 292
  - Channel Bandwidth ..... 292
  - Channel bandwidth (remote control) ..... 614
  - Configuring ..... 291
  - Deactivating limits ..... 292, 474, 478
  - Determining ..... 291, 293
  - Limits ..... 292, 474, 477
  - Measurement ..... 288
  - Measurement (remote control) ..... 614
  - Measurement example ..... 294
  - Multicarrier signal ..... 289, 291, 293
  - Prerequisites ..... 289
  - Results ..... 290
  - Search limits ..... 289, 291, 293
- OBW measurement
  - Centroid frequency ..... 290
- Occupied Bandwidth
  - see OBW ..... 288
- OCXO ..... 130
- Offset
  - Frequency ..... 424
  - Limit lines ..... 540
  - Reference level ..... 430
  - X-axis (statistics) ..... 356
- Offset (channel setting) ..... 69
- On-screen keyboard ..... 76, 78
- Online help
  - Working with ..... 81
- Operating system ..... 23
  - Login ..... 24
  - service packs ..... 23
- Operating temperature ..... 165
- Operation complete
  - Remote ..... 576
- Optimizing
  - Calibration signal display ..... 49
- Options
  - EMI measurement (K54) ..... 385, 402
  - Identification (remote) ..... 576
  - Information ..... 142
  - Installing ..... 142, 144
  - Preamplifier ..... 432
- Orientation
  - Screenshot ..... 123
- Output
  - Audio ..... 753
  - Buffer ..... 188
  - Configuration (remote) ..... 752
  - IF frequency (remote) ..... 753
  - IF Out Frequency ..... 417
  - IF source (remote) ..... 753
  - Noise source ..... 418
  - Parameters ..... 409
  - Video ..... 417, 753
- OVEN
  - Error ..... 74
  - OVEN (status display) ..... 74
- Overlapping commands ..... 185
  - Preventing ..... 186
- Overload
  - RF input (remote) ..... 742
- Overview (configuration) ..... 237
- P**
- Pa (channel bar) ..... 70
- Paint
  - Accessing ..... 26
- Parallel poll register enable
  - Remote ..... 577
- Parameters
  - Block data ..... 182
  - Boolean ..... 181
  - Entering ..... 77, 78
  - Input signal ..... 409
  - Numeric values ..... 180
  - Output ..... 409
  - Passing between applications ..... 88
  - SCPI ..... 179

- Special numeric values ..... 180
- String ..... 181
- Text ..... 181
- partial spans ..... 437, 438
- Passwords
  - Changing ..... 226
  - Service functions ..... 152
- Peak excursion ..... 473, 477, 496, 499
- Peak list ..... 497
  - Configuring ..... 495
  - Displaying ..... 495
  - Evaluation method ..... 261
  - Exporting ..... 499, 567
  - Marker numbers ..... 499
  - Maximum number of peaks ..... 499
  - Peak excursion ..... 473, 477, 499
  - Remote control ..... 814
  - Sort mode ..... 498
  - State ..... 498
  - Trying out ..... 59
- Peak search ..... 393
  - Area (spectrograms) ..... 476
  - Automatic ..... 401, 473, 477
  - Deactivating limits ..... 292, 474, 478
  - Excursion ..... 496
  - Key ..... 478
  - Limits ..... 292, 474, 477, 496
  - List ..... 497
  - Mode ..... 473, 475
  - Mode (spectrograms) ..... 474, 475
  - Reference marker ..... 471
  - Threshold ..... 474, 477
  - Type (spectrograms) ..... 476
  - Zoom limits ..... 474, 478
- Peaks
  - Displaying (SEM) ..... 321
  - Displaying (Spurious Emissions) ..... 343
  - Margin (SEM) ..... 321
  - Margin (Spurious Emissions) ..... 344
  - Marker positioning ..... 478
  - Next ..... 478
  - per range (Spurious Emissions) ..... 344
  - SEM results ..... 297
  - Softkey ..... 478
  - Spurious Emissions ..... 336
- Percent marker
  - CCDF ..... 350
  - Softkey (CCDF) ..... 352
- Performing
  - EMI measurement ..... 404
- Period
  - Gate ranges (statistics) ..... 354
- Persistence spectrum
  - Spectrogram ..... 522
- Phase ..... 403
  - EMI ..... 392
  - LISN control (EMI) ..... 403
- Phase noise markers
  - Programming example ..... 838
- Phase noise measurement
  - Activating/Deactivating ..... 486
  - Deactivating ..... 487
  - Marker ..... 484
  - Reference point ..... 487
  - Remote control ..... 819
- PHN (marker functions) ..... 72
- Ping ..... 224
- PK (trace information) ..... 71
- Ports
  - User ..... 754
- Position
  - Limit line values ..... 547
  - Transducer factors ..... 158
- Positive peak detector
  - EMI ..... 389
- Positive Peak detector ..... 503
- Power
  - Channel, see Channel power ..... 262
  - Harmonics ..... 370
  - Key ..... 39
  - Mean (time domain) ..... 361
  - Peak (time domain) ..... 361
  - Percent (OBW) ..... 291
  - RMS (time domain) ..... 361
  - Standard deviation (time domain) ..... 361
  - Time domain ..... 361
- Power classes
  - Adding/Removing (SEM) ..... 318
  - Ranges (SEM) ..... 318
  - SEM ..... 300, 317
  - SEM results ..... 295
  - Softkey ..... 317
  - Used (SEM) ..... 317
- Power mode
  - Band power measurement ..... 493
  - CP/ACLR ..... 273
  - Softkey ..... 273
- Power sensors
  - Activating/Deactivating ..... 412
  - Applications ..... 411
  - Average count ..... 415
  - Configuration (softkey) ..... 412
  - Configuring - see User Manual ..... 46
  - Connector ..... 46
  - Continuous Value Update ..... 413
  - Duty cycle ..... 415
  - Frequency ..... 413
  - Frequency Coupling ..... 413
  - Measurement time ..... 414
  - Number of readings ..... 415
  - R&S Power Viewer ..... 411
  - Reference level ..... 414
  - Reference level offset ..... 414
  - Results ..... 411
  - Selecting ..... 413
  - Setting up ..... 415
  - Settings ..... 412
  - Unit/Scale ..... 414
  - Using ..... 415
  - Using - see User Manual ..... 46
  - Zeroing ..... 413, 416
- Power supply
  - Connector ..... 44
- Power Unit
  - Softkey ..... 272
- PPC ..... 175
- PPE register ..... 188, 192
- PPU ..... 175
- Preamplifier
  - SEM range ..... 312
  - Setting ..... 432
  - Softkey ..... 432
  - Spurious Emissions range ..... 341

- Predefined standards
    - CP/ACLR ..... 270, 284
  - Preset
    - channel setup settings ..... 102
    - Key ..... 102
    - Recalling settings ..... 112
  - Presetting
    - Channels ..... 238
  - Pretrigger ..... 456
  - Preview
    - Trigger/Gate settings ..... 453
  - Print Screen
    - Softkey ..... 120
  - Printer
    - Selecting ..... 122
  - Printers
    - Installing ..... 122
  - Printing
    - Colors ..... 136, 137, 139
    - Colors (remote) ..... 902
    - Medium ..... 121
    - Screenshots ..... 120, 125
    - Trying out ..... 65
  - Probability range
    - Statistics ..... 356
  - Programming examples
    - ACLR ..... 611
    - AM Modulation Depth ..... 682
    - Band power markers ..... 839
    - Carrier-to-Noise ratio ..... 613
    - Demodulation markers ..... 841
    - EMI measurement ..... 689
    - Frequency sweep ..... 700
    - Marker Peak List ..... 837
    - Marker search (spectrograms) ..... 836
    - Markers ..... 834
    - n dB down markers ..... 840
    - Noise markers ..... 838
    - Phase noise markers ..... 838
    - Reference Marker ..... 837
    - SEM ..... 642
    - Sequencer ..... 585
    - Service request ..... 951
    - Signal count markers ..... 842
    - Spectrogram ..... 781
    - Spurious Emissions measurement ..... 654
    - Statistics ..... 664, 837, 859, 860
    - TOI ..... 680
  - Protection
    - RF input (remote) ..... 742
  - Protocol
    - VXI ..... 170
  - Ptransition ..... 189
  - Pulsed signals
    - EMI detector ..... 389, 390
- Q**
- Quasipeak detector
    - EMI ..... 389
  - Queries ..... 176, 184
    - Status ..... 202
  - Question mark ..... 182, 184
  - Quick Config
    - Traces ..... 513
  - Quick recall
    - Settings ..... 104
  - Quick save
    - Settings ..... 104
  - Quotation mark ..... 182
- R**
- R&S FSP
    - Emulating ..... 212
    - Emulating (remote) ..... 915
  - R&S FSQ
    - Emulating ..... 212
    - Emulating (remote) ..... 915
  - R&S FSU
    - Emulating ..... 212
    - Emulating (remote) ..... 915
  - R&S FSV
    - Emulating ..... 212
    - Emulating (remote) ..... 915
  - R&S Power Viewer Plus ..... 411
  - R&S Support ..... 148
  - Rackmounting ..... 17
  - Range ..... 433
    - Scaling ..... 433
    - X-axis (statistics) ..... 356
  - Ranges
    - Definition (SEM) ..... 299
    - Deleting (SEM) ..... 314
    - Deleting (Spurious Emissions) ..... 342
    - Inserting (SEM) ..... 314
    - Inserting (Spurious Emissions) ..... 342
    - Reference (SEM) ..... 299, 315
    - Remote control (Spurious Emissions) ..... 337
    - Rules (SEM) ..... 299
    - Rules (Spurious Emissions) ..... 337
    - SEM ..... 299
    - Symmetrical (SEM) ..... 300
  - RBW
    - see Resolution Bandwidth ..... 435
  - RBW (channel setting) ..... 69
  - Ready for trigger
    - Status register ..... 193
  - Rear panel
    - Overview ..... 43
  - Rebooting
    - Remote control ..... 579
  - Recalling
    - Settings ..... 102, 104, 107, 110
    - Settings for preset ..... 112
    - Softkey ..... 107
  - Recommendations
    - Remote control programming ..... 203
  - Ref Level (channel setting) ..... 69
  - Ref Lvl = Mkr Lvl ..... 479
  - Ref. In
    - Connector ..... 45
  - Ref. Out
    - Connector ..... 45
  - Reference
    - Fixed ..... 471, 489
    - Fixed (channel power) ..... 273
    - Fixed (Delta marker) ..... 500
    - Frequency (remote control) ..... 890
    - Marker ..... 471, 489
    - Phase noise measurement ..... 487
    - Power (SEM) ..... 316
    - Range (SEM) ..... 299, 315

- Reference channel
  - CP/ACLR ..... 272
- Reference level ..... 426, 429
  - Adjusting to transducer factors ..... 156
  - Auto level ..... 431, 462
  - CP/ACLR ..... 268
  - Offset ..... 430
  - Offset (Power sensor) ..... 414
  - Position ..... 433
  - Power sensor ..... 414
  - SEM range ..... 311
  - Setting to marker ..... 479
  - Spurious Emissions range ..... 341
  - Statistics ..... 356
  - Unit ..... 429, 430
  - Value ..... 429
- Reference marker ..... 397, 468
- Reference Marker
  - Programming example ..... 837
- Reference range
  - Softkey ..... 315
- Registers ..... 188
- Release notes ..... 11
- Remote commands
  - Deprecated ..... 959
- Remote control ..... 84
  - Blocked ..... 965
  - Errors ..... 965
  - Ignored commands ..... 203
  - Interfaces ..... 168
  - LXI settings ..... 213
  - Protocols ..... 168
  - Sequential commands ..... 965
- Remote Desktop ..... 218, 229
  - Client ..... 231
  - Ending session ..... 233
  - Setting up a connection ..... 233
  - Setting up controller ..... 231
  - Setting up instrument ..... 230
- Remote display
  - Update ..... 210
- Remote operation
  - Configuring ..... 167
  - Deactivating the instrument ..... 235
  - GPIO address ..... 224
  - GPIO settings ..... 208
  - see also Remote control ..... 167
  - Setting up ..... 218
  - Settings ..... 206
  - Starting ..... 235
  - Stopping ..... 236
- Repetition interval ..... 456
- Reset values
  - Remote ..... 577
- Resetting
  - RF input protection ..... 742
- Resolution bandwidth
  - Auto (Softkey) ..... 401, 441
  - CP/ACLR ..... 267
  - Harmonics ..... 371
  - Impact ..... 435
  - Manual (Softkey) ..... 401, 441
  - SEM range ..... 310
  - Spurious Emissions range ..... 340
- Resolution bandwidth (EMI) ..... 388, 402
- Restoring
  - Channel settings ..... 238
  - Standard files ..... 320
- Result displays
  - Diagram ..... 260
  - Marker table ..... 260
  - Peak list ..... 261
  - Programming example ..... 709
  - Result Summary ..... 261
  - Spectrogram ..... 262
- Result Summary
  - Configuration (SEM) ..... 320
  - Evaluation method ..... 261
  - Result display ..... 261
  - Saving (SEM) ..... 322
- Results
  - Analyzing ..... 404
  - CP/ACLR measurements ..... 263
  - Data format (remote) ..... 780, 886
  - Exporting ..... 563
  - Managing ..... 101
  - OBW ..... 290
  - SEM ..... 295
  - SEM (remote) ..... 298
  - Storing (remote) ..... 886
- Revision string
  - GPIO ..... 213, 916
  - GPIO (remote control) ..... 908
  - Resetting ..... 213
- RF attenuation
  - Auto ..... 431
  - Impact ..... 428
  - Manual ..... 431
  - Mode (SEM range) ..... 311
  - Mode (Spurious Emissions range) ..... 341
  - Noise floor ..... 428
  - SEM range ..... 311
  - Spurious Emissions range ..... 341
- RF input
  - Overload protection (remote) ..... 742
  - Remote ..... 742
- RF Input
  - Connector ..... 42
- RF OVLD
  - Error ..... 74, 964
- RF OVLD (status display) ..... 74, 964
- RM (trace information) ..... 71
- RMS
  - VBW ..... 505
- RMS Average
  - Detector ..... 388
- RMS Average detector
  - EMI ..... 391
- RMS detector
  - EMI ..... 503
  - EMI ..... 389
  - VBW ..... 436
- Rotary knob ..... 42
- RRC filter
  - SEM ..... 316
- RUN CONT
  - Key ..... 241, 446, 526
- RUN SINGLE
  - Key ..... 241, 445, 446, 527



**S**

- S/N ratio
  - Measurement example ..... 245, 258
- SA (trace information) ..... 71
- Safety instructions ..... 11
- Sample detector ..... 503
  - EMI ..... 389
- Samples
  - Statistics ..... 352, 361
- Save/Recall Mode
  - Settings ..... 108
- Savesets
  - Settings ..... 105
- Saving
  - Data types ..... 106
  - Functions ..... 107
  - Instrument settings ..... 111
  - Limit lines ..... 548
  - Screenshots ..... 125
  - SEM result files ..... 325
  - Settings ..... 107, 320
  - Softkey ..... 107
  - Spurious Emissions result files ..... 345
  - Transducer lines ..... 158
  - Trying out ..... 63, 65
- Scaling
  - Amplitude range, automatically ..... 433
  - Configuration ..... 432
  - Default (statistics) ..... 356
  - Statistics ..... 355
  - X-axis (remote control) ..... 713
  - Y-axis ..... 428, 433
  - Y-axis (remote control) ..... 734
- SCPI
  - Parameters ..... 179
  - Syntax ..... 177
  - version ..... 175
- SCPI confirmed commands ..... 176
- Screenshots
  - Printing ..... 120, 125
  - Saving ..... 120, 125
  - Trying out ..... 65
- SDC ..... 175
- Search limits
  - Deactivating ..... 292, 474, 478
  - OBW ..... 289, 291
- Search Limits
  - Activating ..... 292, 474, 477
- Search Mode
  - Spectrogram markers ..... 474
- Search range
  - Zoom area ..... 555
- Search settings
  - Trying out ..... 59
- Search Signals
  - Softkey ..... 379, 384
- Searching
  - Configuration ..... 472
  - Configuration (softkey) ..... 474
  - In help ..... 82
- Second harmonic intercept ..... 367
- Security procedures ..... 11
- Select Frame
  - Softkey ..... 447, 526
- Select Marker ..... 399, 469
- Self-alignment ..... 164
  - Aborting ..... 165
  - Starting ..... 165
- Self-test
  - Performing ..... 149, 165
  - Remote ..... 578
  - Results ..... 149, 894
  - Settings ..... 149
  - Temperature ..... 166
- Selftest
  - Remote ..... 912
- SEM ..... 294
  - About ..... 295
  - Adding power classes ..... 318
  - Alpha value (RRC filter) ..... 317
  - Applications ..... 295
  - Channel power settings ..... 316
  - Configuring ..... 308, 322
  - Deleting ranges ..... 314
  - Displaying peaks ..... 321
  - Exporting results ..... 325
  - Fast mode ..... 303, 310
  - Filter type ..... 310
  - Format description of export files ..... 333
  - Format description of settings files ..... 328
  - Inserting ranges ..... 314
  - Limit absolute ..... 312
  - Limit check ..... 312
  - Limit lines ..... 301
  - Limit relative ..... 312
  - List evaluation ..... 320
  - List evaluation (remote control) ..... 640
  - List evaluation state ..... 321
  - Measurement (remote control) ..... 615
  - Measurement result list ..... 320
  - Multiple sub blocks (Multi-SEM) ..... 304
  - Peak margins ..... 321
  - Performing ..... 322
  - Power class ranges ..... 318
  - Power classes ..... 300, 317
  - Power classes (remote control) ..... 635
  - Preamplifier ..... 312
  - Programming example ..... 642
  - Provided settings files ..... 328
  - Range start/stop ..... 310
  - Ranges ..... 299
  - RBW ..... 310
  - Reference level ..... 311
  - Reference power ..... 316
  - Reference range ..... 315
  - Reference range (remote control) ..... 633
  - Restoring standard files ..... 320
  - Result files ..... 325
  - Results ..... 295
  - Results (Multi-SEM) ..... 297
  - Results (remote control) ..... 641, 654
  - Results (remote) ..... 298
  - RF attenuation ..... 311
  - RF attenuation mode ..... 311
  - RRC filter ..... 316
  - Saving result summary ..... 322
  - Settings files ..... 318, 324
  - Standard files ..... 318
  - Standards (remote control) ..... 616
  - Sweep List ..... 309
  - Sweep list (remote control) ..... 619
  - Sweep Points ..... 313

- Sweep Time ..... 311
- Sweep Time Mode ..... 311
- Transducer ..... 312
- Tx Bandwidth ..... 316
- Used power classes ..... 317
- VBW ..... 311
- Sensitivity
  - RBW ..... 435
- Sequencer ..... 69
  - Aborted ..... 149, 165
  - Aborting (remote) ..... 583
  - Activating (remote) ..... 584
  - Channel Setups ..... 89
  - Example ..... 91
  - Mode ..... 90, 92
  - Mode (remote) ..... 584
  - Programming example ..... 585
  - Remote ..... 589
  - Remote control ..... 579
  - RUN SINGLE ..... 91
  - Setting up ..... 92
  - Single Sweep ..... 91
  - Softkey ..... 92
  - State ..... 92
  - Trying out ..... 56
- Sequential commands ..... 185
  - Errors ..... 965
- Service functions ..... 147, 150, 151
  - Passwords ..... 152
  - Results ..... 152
- Service manual ..... 10
- Service packs ..... 23
- Service request (SRQ) ..... 167, 188, 191, 200
- Service request enable register (SRE) ..... 188, 191
  - Remote ..... 577
- Set CP Reference
  - Softkey ..... 273
- Setting commands ..... 176
- Settings
  - filename ..... 108, 111, 319
  - Format description (SEM) ..... 328
  - Loading ..... 111
  - Managing ..... 101
  - Provided files (SEM) ..... 328
  - Recalling ..... 102, 104
  - Recalling; restrictions ..... 103
  - Restoring files ..... 320
  - Saving ..... 106, 111
  - Storage location ..... 108, 110, 319
  - Storing ..... 102, 104
- Settings files
  - Deleting ..... 320
  - Deleting (SEM) ..... 324
  - Loading ..... 320
  - Loading (SEM) ..... 324
  - Managing (SEM) ..... 324
  - Restoring (SEM) ..... 324
  - Saving ..... 320
  - Saving (SEM) ..... 324
- Sgl (channel bar) ..... 70
- Shift x
  - Limit lines ..... 548
  - Transducer lines ..... 158
- Shift y
  - Limit lines ..... 548
  - Transducer lines ..... 158
- Shifting
  - Limit lines ..... 540
- Shutdown
  - Automatic ..... 165
  - Remote control ..... 579
- Signal capturing
  - Duration (remote) ..... 726, 728
- Signal count
  - Marker ..... 481
  - Remote control ..... 829
  - Resolution ..... 481
- Signal count markers
  - Programming example ..... 842
- Signal counter
  - Measurement example ..... 244
- Signal tracking ..... 424
  - Bandwidth ..... 424
  - Softkey ..... 424
  - State ..... 424
  - Threshold ..... 424
  - Trace ..... 424
- Single Sequencer
  - Softkey ..... 92
- Single sweep
  - Softkey ..... 241, 445, 527
- Single zoom ..... 554, 556
- Sinusoidal signals
  - Measurement example ..... 242
- Slope
  - Edge gate ..... 457
  - Trigger ..... 457, 738
- SmartGrid
  - Activating ..... 96
  - Arranging windows ..... 97
  - Display ..... 94
  - Evaluation bar ..... 97
  - Features ..... 94
  - Mode ..... 96
  - Programming example ..... 709
  - Trying out ..... 50
- Smoothing
  - Traces ..... 508
  - Traces (group delay) ..... 512
- Soft front panels
  - Using ..... 140
- softkey
  - Calibration Frequency WB ..... 893
  - Trace Mode (remote control) ..... 666, 667
- Softkey bar
  - Hiding/restoring ..... 134
- Softkeys
  - # of Samples (APD, CCDF) ..... 352
  - % Power Bandwidth ..... 291
  - ACLR Mode ..... 272
  - Adjust Settings ..... 273, 287, 292, 371
  - Adjust Settings (APD) ..... 353, 357
  - Adjust X-Axis ..... 342
  - All Functions Off ..... 499
  - Amplitude Config ..... 429
  - Analysis BW (APD, CCDF) ..... 352
  - Auto All ..... 462
  - Auto Freq ..... 462
  - Auto Level ..... 431, 462
  - Bandwidth Config ..... 440
  - C/N ..... 287
  - C/No ..... 287
  - Carrier Noise Config ..... 286

|                                |                    |
|--------------------------------|--------------------|
| Center                         | 422                |
| Center = Mkr Freq              | 479                |
| Channel Bandwidth              | 287, 292           |
| Channel-defined Sequencer      | 92                 |
| Clear Spectrogram              | 447, 527           |
| Color Mapping                  | 526                |
| Comment                        | 118                |
| Continue Single Sweep          | 241, 446           |
| Continuous Sequencer           | 92                 |
| Continuous Sweep               | 241, 446, 526      |
| CP/ACLR Settings               | 269                |
| CP/ACLR Standard               | 270                |
| Display Config                 | 94                 |
| Export                         | 114                |
| Export config                  | 115                |
| External                       | 455                |
| Frame count                    | 447                |
| Free Run                       | 454                |
| Frequency Config               | 420                |
| Full Span                      | 422                |
| Gated Trigger                  | 353                |
| Harmonic RBW Auto              | 371                |
| Harmonic Sweep Time            | 371                |
| History Depth                  | 526                |
| Horizontal Line 1/2            | 537                |
| I/Q Export                     | 115                |
| IF Power                       | 455                |
| Import                         | 113                |
| Install Printer                | 122                |
| Last Span                      | 423                |
| List evaluation                | 320                |
| Lower Level Hysteresis         | 463                |
| Marker 1/2/3                   | 383                |
| Marker 1/2/3/4                 | 378                |
| Marker Config                  | 467, 470           |
| Marker Search Area             | 476                |
| Marker Search Type             | 476                |
| Marker to Trace                | 398, 469           |
| Meastime Auto                  | 462                |
| Meastime Manual                | 462                |
| Min                            | 479                |
| Next Min                       | 479                |
| Next Mode X                    | 475                |
| Next Mode Y                    | 475                |
| Next Peak                      | 478                |
| No. of Harmonics               | 371                |
| Norm/Delta                     | 397, 468, 484      |
| Peak                           | 478                |
| Percent Marker                 | 352                |
| Power classes                  | 317                |
| Power Mode                     | 273                |
| Power Sensor Config            | 412                |
| Power Unit                     | 272                |
| Preamp                         | 432                |
| Print Screen                   | 120                |
| R&S Support                    | 148                |
| Recall                         | 107                |
| Recall File                    | 106, 109           |
| Ref Level                      | 429                |
| Ref Level (APD; CCDF)          | 356                |
| Ref Level Offset               | 430                |
| Reference range                | 315                |
| Res BW Auto                    | 401, 441           |
| Res BW Auto (remote)           | 723                |
| Res BW Manual                  | 401, 441           |
| RF Atten Auto                  | 431                |
| RF Atten Manual                | 431                |
| Save                           | 107                |
| Save File                      | 109                |
| Search Config                  | 472, 474           |
| Search Signals                 | 379, 384           |
| Select Frame                   | 447, 526           |
| Select Marker                  | 399, 469           |
| Sequencer                      | 92                 |
| Set CP Reference               | 273                |
| Signal Track                   | 424                |
| Single Sequencer               | 92                 |
| Single Sweep                   | 241, 445, 527      |
| Span Manual                    | 422                |
| Standard files                 | 318                |
| Start                          | 422                |
| Startup Recall                 | 109                |
| Startup Recall (On/Off)        | 110                |
| Status                         | 75                 |
| Stop                           | 422                |
| Sweep Config                   | 440                |
| Sweep List                     | 309                |
| Sweep Time                     | 273                |
| Sweep Time Auto                | 442                |
| Sweep Time Manual              | 442                |
| Time                           | 455                |
| Timestamp                      | 526                |
| Trace 1/2/3/4                  | 513                |
| Trace Config                   | 509, 533           |
| Transducer                     | 154                |
| Trigger Offset                 | 456                |
| Trigger/Gate Config            | 453                |
| Upper Level Hysteresis         | 463                |
| Vertical Line 1/2              | 537                |
| Video BW Auto                  | 442                |
| Video BW Manual                | 442                |
| Zero Span                      | 423                |
| Sort mode                      |                    |
| Peak list                      | 498                |
| Spacings                       |                    |
| CP/ACLR                        | 275                |
| Span                           | 422                |
| Band power measurement         | 493                |
| Carrier-to-Noise               | 285                |
| CP/ACLR                        | 266                |
| Manual                         | 422                |
| Span/RBW coupling              | 437                |
| SPD                            | 175                |
| SPE                            | 175                |
| Speaker                        |                    |
| Remote control                 | 755                |
| Spectrograms                   |                    |
| 3-dimensional                  | 525, 526           |
| Activating/Deactivating        | 525                |
| Clearing                       | 447, 527           |
| Color curve                    | 522, 528, 532      |
| Color mapping                  | 521, 526, 527, 531 |
| Color mapping (remote control) | 771                |
| Color scheme                   | 521, 529           |
| Configuring                    | 530                |
| Configuring (remote control)   | 765                |
| Continue frame                 | 517                |
| Display                        | 515                |
| Display depth (3-D)            | 526                |
| Displaying                     | 529                |
| Evaluation method              | 262                |
| Frame count                    | 517                |
| Frames (remote control)        | 766                |
| History depth                  | 526                |

- Markers ..... 518, 530
- Markers (remote control) ..... 803
- Programming example ..... 781
- Removing ..... 530
- Scaling ..... 517
- Selecting frames ..... 447, 526
- Settings ..... 524
- Size ..... 525
- Sweep count ..... 517
- Time frames ..... 517
- Timestamps ..... 518, 526
- Trying out ..... 50
- Value range ..... 522, 531
- Spectrum
  - Application ..... 86
- Spectrum Emission Mask
  - see SEM ..... 294
- Splitters
  - Window size ..... 98
- Spurious Emissions ..... 335
  - About ..... 335
  - Configuring ..... 338
  - Deleting ranges ..... 342
  - Detector ..... 341
  - Displaying peaks ..... 343
  - Evaluation list ..... 336
  - Exporting results ..... 345
  - Filter type ..... 340
  - Format description of export files ..... 346
  - Inserting ranges ..... 342
  - Limit absolute ..... 342
  - Limit check ..... 342
  - Limit lines ..... 337
  - List details ..... 344
  - List evaluation ..... 343
  - List evaluation state ..... 343
  - Measurement (remote control) ..... 645
  - Measurement result list ..... 343
  - Peak margins ..... 344
  - Peaks ..... 336
  - Peaks per range ..... 344
  - Performing ..... 338, 344
  - Preamplifier ..... 341
  - Programming example ..... 654
  - Range start/stop ..... 340
  - Ranges ..... 337
  - RBW ..... 340
  - Reference level ..... 341
  - Result files ..... 345
  - Results ..... 335
  - RF attenuation ..... 341
  - RF attenuation mode ..... 341
  - Saving list evaluation ..... 344
  - Sweep list ..... 339, 645
  - Sweep points ..... 341
  - Sweep time ..... 340
  - Sweep time mode ..... 340
  - Transducer ..... 342
  - VBW ..... 340
- Squelch
  - Remote control ..... 831
- SRE (service request enable register) ..... 191
- SRQ (service request) ..... 191, 200
- Standard deviation
  - Power (time domain) ..... 361
- Standard files
  - Multi-SEM ..... 319
  - Softkey ..... 318
- Standards
  - CP/ACLR measurements ..... 270
  - Format description (SEM) ..... 328
  - Provided files (SEM) ..... 328
  - Restoring files (SEM) ..... 320
  - Settings files (SEM) ..... 318
- Star (yellow)
  - see Invalid data icon ..... 68
- Start frequency
  - Softkey ..... 422
- Startup recall
  - Remote ..... 872
- Startup Recall
  - Softkey ..... 110
- Statistics
  - Default scaling ..... 356
  - Gate (remote control) ..... 658
  - Gated trigger ..... 350
  - Measurements ..... 347
  - Measurements (remote control) ..... 656
  - Optimizing ..... 361
  - Programming example ..... 664, 837, 859, 860
  - Scaling ..... 355
  - Scaling (remote control) ..... 660
  - see also APD, CCDF ..... 347
- Status
  - Queries ..... 202
- Status bar
  - Color coding ..... 73, 963
  - Error messages ..... 73, 963
  - Hiding/restoring ..... 134
- Status byte
  - Remote ..... 575, 577
- Status byte (STB) ..... 191
- Status byte register (STB) ..... 188
- Status display ..... 72
- Status registers ..... 188
  - CONDition ..... 189
  - ENABle ..... 189
  - EVENT ..... 189
  - model ..... 189
  - NTRansition ..... 189
  - parts ..... 189
  - PTRansition ..... 189
  - STAT:QUES:POW ..... 742
  - STATus:OPERation ..... 193
  - STATus:QUESTionable ..... 194
  - STATus:QUESTionable:ACPLimit ..... 195
  - STATus:QUESTionable:EXTended ..... 196
  - STATus:QUESTionable:EXTended:INFO ..... 196
  - STATus:QUESTionable:FREQuency ..... 197
  - STATus:QUESTionable:LIMit ..... 197
  - STATus:QUESTionable:LMARgin ..... 198
  - STATus:QUESTionable:POWer ..... 199
  - STATus:QUESTionable:TEMPerature ..... 199
  - STATus:QUESTionable:TEMPerature ..... 163, 894
  - STATus:QUESTionable:TIme ..... 200
- Status reporting system ..... 187
  - Application ..... 200
  - Common commands ..... 574
- Step size
  - Markers ..... 471
  - Markers (remote control) ..... 790

- Stop frequency
    - Softkey ..... 422
  - Storage location
    - Data files ..... 107
    - Settings ..... 108, 110, 319
  - Storage settings
    - File type ..... 108
  - Storing
    - Settings ..... 102, 104
  - String in remote commands ..... 181
  - Sub blocks
    - Number (Multi-SEM) ..... 315
    - Standard files ..... 319
  - Subnet Mask ..... 208
  - Subwindows
    - Spectrogram ..... 525
  - Suffixes ..... 178
    - Common ..... 574
  - Support ..... 968
    - Information ..... 148
    - Information (remote) ..... 912
  - Suppressing
    - File name dialog ..... 122
  - Sweep
    - Aborting ..... 445, 446, 526, 527
    - Configuration (Softkey) ..... 440
    - Continuous ..... 241
    - Count ..... 439
    - Count (Spectrograms) ..... 517
    - Default settings ..... 434
    - Mode ..... 241, 440
    - Performing ..... 241
    - Points ..... 439, 503
    - Points (SEM range) ..... 313
    - Points (Spurious Emissions range) ..... 341
    - Settings (Spectrogram) ..... 447
    - Single ..... 241
    - Time (remote) ..... 726, 728
    - Type ..... 437
  - Sweep Count ..... 444
  - Sweep list
    - Deleting ranges ..... 342
    - Detector ..... 341
    - Filter type ..... 340
    - Inserting ranges ..... 342
    - Limit absolute ..... 342
    - Limit check ..... 342
    - Preamplifier ..... 341
    - Range start/stop (Spurious Emissions) ..... 340
    - RBW ..... 340
    - Reference level ..... 341
    - RF attenuation ..... 341
    - RF attenuation mode ..... 341
    - Spurious Emissions ..... 339
    - Sweep points ..... 341
    - Sweep time ..... 340
    - Sweep time mode ..... 340
    - Transducer ..... 342
    - VBW ..... 340
  - Sweep List
    - Deleting ranges ..... 314
    - Fast SEM ..... 310
    - Filter type ..... 310
    - Inserting ranges ..... 314
    - Limit absolute ..... 312
    - Limit check ..... 312
    - Limit relative ..... 312
  - Preamplifier ..... 312
  - Range start/stop (SEM) ..... 310
  - RBW ..... 310
  - Reference level ..... 311
  - RF attenuation ..... 311
  - RF attenuation mode ..... 311
  - SEM ..... 309
  - Softkey ..... 309
  - Sweep Points (SEM) ..... 313
  - Sweep Time ..... 311
  - Sweep Time Mode ..... 311
  - Symmetrical ..... 314
  - Transducer ..... 312
  - VBW ..... 311
  - Sweep points
    - EMI ..... 391
    - Logarithmic x-axis scaling ..... 419
  - Sweep Points ..... 444
  - Sweep Repeat
    - GPIO ..... 212
  - Sweep status
    - Status register ..... 193
  - Sweep time
    - Harmonics ..... 371
    - Spurious Emissions range ..... 340
    - Statistics ..... 352
  - Sweep Time ..... 439
    - Auto (Softkey) ..... 442
    - CP/ACLR ..... 265, 273
    - Manual (Softkey) ..... 442
    - SEM range ..... 311
    - Softkey ..... 273
    - Values ..... 442
  - Sweep time mode
    - Spurious Emissions range ..... 340
  - Sweep Time Mode
    - SEM range ..... 311
  - SWT (channel setting) ..... 69
  - Symmetric setup
    - SEM ..... 314
    - SEM ranges ..... 300
  - Syntax elements
    - SCPI ..... 182
  - System
    - Configuration ..... 142
    - Configuration (remote) ..... 908
    - Keys ..... 39
    - Messages ..... 144
- ## T
- Channel Setups ..... 85
    - MultiView ..... 68, 86
    - Switching ..... 67
  - Task bar
    - Accessing ..... 26
  - Tdf (channel bar) ..... 70
  - Technical support ..... 968
  - Temperature
    - Check ..... 163
    - Check (remote) ..... 894
    - Frontend ..... 163
    - Frontend (remote) ..... 894
    - Frontend, status bit ..... 163, 199
    - Self-alignment ..... 163

- Self-alignment (remote) ..... 894
- Status register ..... 199
- Text parameters in remote commands ..... 181
- Theme
  - Display ..... 136, 137
  - Display (remote) ..... 902
- Third order intercept point
  - see TOI ..... 372
- Threshold
  - Limit lines ..... 539, 546
  - Peak search ..... 474, 477
  - Signal tracking ..... 424
- Time
  - Format ..... 132
  - Hiding/restoring ..... 134
  - Instrument setting ..... 132
  - Setting ..... 36
- Time Domain Power ..... 361
  - About ..... 361
  - Configuring ..... 363
  - Limit lines ..... 362, 364
  - Measurement (remote control) ..... 665
  - Measurement example ..... 365
  - Measuring ..... 364
  - Restricting range ..... 362
  - Results ..... 361, 364
- Time frames
  - Configuring ..... 447
  - Continuing ..... 447
  - Navigating ..... 447, 518
  - per sweep ..... 447
  - Selecting ..... 447, 526
  - Spectrograms ..... 517
- Time lines
  - Remote control ..... 843
- Time trigger
  - Repetition interval ..... 456
  - Softkey ..... 455
- Timestamps
  - Softkey (Spectrogram) ..... 526
  - Spectrograms ..... 518, 526
- TOI ..... 372
  - About the measurement ..... 373
  - Basics ..... 373
  - Calculation method ..... 375
  - Configuring ..... 378
  - Determining ..... 379
  - Markers ..... 378
  - Programming example ..... 680
  - Results ..... 377
  - Search signals ..... 379
- TOI (marker functions) ..... 72
- Toolbar
  - Hiding/restoring ..... 133
  - Overview ..... 75
- Total Harmonic Distortion
  - Measurement ..... 370
- touchscreen
  - Alignment ..... 164, 165
- Touchscreen
  - Alignment ..... 164, 166
  - Colors ..... 136
  - De-/Activating ..... 132
  - Displayed items ..... 132
  - Overview ..... 37
  - Settings ..... 131
  - Theme ..... 137
- Trace information ..... 71
  - Detector type ..... 71
  - Trace number ..... 71
  - Window title bar ..... 70
- Trace math
  - Functions ..... 534
  - Settings ..... 533
- Trace smoothing ..... 508
- Traces ..... 513
  - Average mode ..... 512
  - Averaging ..... 508
  - Averaging (algorithm) ..... 507
  - Averaging (remote control) ..... 764
  - Configuration ..... 509
  - Configuration (Softkey) ..... 533
  - Configuring ..... 514
  - Configuring (remote control) ..... 760
  - Copying ..... 513
  - Copying (remote control) ..... 765
  - Detector ..... 398, 503, 511
  - Detector (remote control) ..... 764
  - Export format ..... 115, 564, 566
  - Exporting ..... 114, 563, 564, 567
  - Hold ..... 511
  - Mode ..... 510
  - Mode (CP/ACLR) ..... 268
  - Mode (remote) ..... 760
  - Saving ..... 106
  - Settings ..... 503
  - Settings (remote control) ..... 760
  - Settings, predefined ..... 513
- Traces to be Checked
  - Limit lines ..... 544
- Tracking bandwidth ..... 424
- Tracking threshold ..... 424
- Transducer factor ..... 393
- Transducers
  - Activating/Deactivating ..... 155
  - Adjusting reference level ..... 156
  - Checking ..... 160
  - Comment ..... 157
  - Compatibility ..... 155
  - Compatible ..... 160
  - Configuration ..... 153
  - Configuration (remote control) ..... 895
  - Configuring ..... 160
  - Copying ..... 156, 161
  - Creating ..... 156, 162
  - Data points ..... 158
  - Deleting ..... 156, 161
  - Deleting values ..... 158
  - Editing ..... 156, 161
  - Factors ..... 152
  - Inserting values ..... 158
  - Managing ..... 154
  - Name ..... 157
  - Recalling ..... 104
  - Saving ..... 104, 106, 158
  - SEM range ..... 312
  - Settings ..... 154
  - Shifting ..... 158, 162
  - Softkey ..... 154
  - Spurious Emissions range ..... 342
  - Storing ..... 153
  - Unit ..... 157
  - Validity ..... 153
  - View filter ..... 156

- X-axis ..... 158
- Y-axis unit ..... 153
- TRG (channel bar) ..... 70
- Trigger
  - Configuration preview ..... 453
  - Drop-out time ..... 456
  - Drop-Out Time ..... 451
  - Event (remote) ..... 578
  - External (remote) ..... 738
  - External, errors ..... 965
  - Holdoff ..... 452, 457
  - Hysteresis ..... 451, 456
  - Measurements ..... 450
  - Offset ..... 450, 456
  - Slope ..... 457, 738
  - Status register ..... 193
- Trigger In
  - Connector ..... 45
- Trigger level ..... 455
  - External trigger (remote) ..... 737
  - I/Q Power (remote) ..... 737
  - IF Power (remote) ..... 737
- Trigger source ..... 450, 454
  - External ..... 455
  - Free Run ..... 454
  - IF Power ..... 455
  - Time ..... 455
  - Video ..... 455
- Trigger/Gate
  - Configuration (Softkey) ..... 453
- TRK (marker functions) ..... 72
- Troubleshooting
  - CP/ACLR ..... 283
  - File name error ..... 872
  - Input overload ..... 742
  - Remote control programs ..... 210, 966
  - Timeout for data capture ..... 966
  - Trace display ..... 966
- Trying out
  - Prerequisites ..... 48
- Tx Bandwidth
  - SEM ..... 316
- U**
- UNCAL
  - Error ..... 74, 964
- UNCAL (status display) ..... 74, 964
- Units
  - Power sensor ..... 414
  - Reference level ..... 429, 430
  - Transducer factors ..... 157
  - Y-axis (statistics) ..... 356
- UP ..... 180
- Update Path
  - Remote control ..... 911
- Update rate
  - Display ..... 132
- Updating
  - Firmware ..... 145
- Upper Level Hysteresis ..... 463
- USB
  - Connector ..... 45
  - Connectors ..... 39
- User ports
  - Remote control ..... 754
- User standards
  - CP/ACLR ..... 270
  - Loading (CP/ACLR) ..... 279
  - Managing ..... 270
  - Storing (CP/ACLR) ..... 279
- Users
  - Network ..... 225
  - Password ..... 226
- V**
- V network ..... 403
- V-network
  - EMI ..... 392
- VBW
  - CP/ACLR ..... 267
  - RMS detector ..... 505
  - see Video bandwidth ..... 436
  - SEM range ..... 311
  - Spurious Emissions range ..... 340
- VBW (channel setting) ..... 69
- VBW/RBW coupling ..... 436
- Version information ..... 142
- Vertical Line 1/2
  - Softkeys ..... 537
- Vertical stroke ..... 182
- Video
  - Trigger source ..... 455
- Video bandwidth ..... 442
  - Auto (Softkey) ..... 442
  - Impact ..... 436
  - Manual (Softkey) ..... 442
  - RMS detector ..... 436
- Video output ..... 417, 753
- View filter
  - Limit lines ..... 544
  - Transducer lines ..... 156
- Virus protection ..... 23
- VISA ..... 168, 169
  - Libraries ..... 176
  - Resource string ..... 169, 176
- Visible
  - Limit lines ..... 544
- Volume
  - Remote control ..... 755
- VXI protocol ..... 170
- W**
- Wait
  - Remote ..... 578
- Waiting for trigger
  - Status register ..... 193
- Warmup time ..... 165
- Web browser
  - Configuration interface ..... 222
- Weighting filters
  - CP/ACLR ..... 276
  - Remote ..... 601
- White noise
  - Measurement example (statistics) ..... 359
- White papers ..... 11
- White space ..... 182
- Window title bar ..... 70
- Windows ..... 23
  - Access ..... 26
  - Adding ..... 97

|                          |                   |
|--------------------------|-------------------|
| Adding (remote) .....    | 703               |
| Arranging .....          | 97                |
| Closing .....            | 97                |
| Closing (remote) .....   | 708               |
| Dialog boxes .....       | 77                |
| Layout (remote) .....    | 706               |
| Querying (remote) .....  | 704               |
| Replacing (remote) ..... | 706               |
| Size .....               | 98                |
| Types (remote) .....     | 703               |
| WordPad                  |                   |
| Accessing .....          | 26                |
| WRONG_FW                 |                   |
| Error .....              | 74, 145, 163, 964 |

**X**

|                                      |          |
|--------------------------------------|----------|
| X-axis                               |          |
| Adjusting (Spurious Emissions) ..... | 342      |
| Limit lines .....                    | 547      |
| Scaling .....                        | 401, 419 |
| Transducer lines .....               | 158      |
| X-Offset                             |          |
| Limit lines .....                    | 544      |
| X-value                              |          |
| Marker .....                         | 397, 468 |

**Y**

|                             |          |
|-----------------------------|----------|
| Y-axis                      |          |
| Limit lines .....           | 547      |
| Max/Min (statistics) .....  | 356      |
| Optimizing display .....    | 434      |
| Scaling .....               | 428, 433 |
| Settings .....              | 432      |
| Y-Offset                    |          |
| Limit lines .....           | 545      |
| Yellow star                 |          |
| see Invalid data icon ..... | 68       |

**Z**

|                                    |          |
|------------------------------------|----------|
| Zero span                          |          |
| Measurement .....                  | 240      |
| Measurement examples .....         | 254      |
| Softkey .....                      | 423      |
| Zeroing                            |          |
| Power sensor .....                 | 413      |
| Zoom                               |          |
| Graphical .....                    | 80       |
| Measurement .....                  | 80       |
| Zoom limits                        |          |
| Search range .....                 | 555      |
| Using for searches .....           | 474, 478 |
| Zooming .....                      | 554, 558 |
| Activating (remote) .....          | 757      |
| Area (Multiple mode, remote) ..... | 758      |
| Area (remote) .....                | 756      |
| Multiple mode .....                | 554, 556 |
| Multiple mode (remote) .....       | 757, 759 |
| Remote .....                       | 756      |
| Restoring original display .....   | 557      |
| Single mode .....                  | 554, 556 |
| Single mode (remote) .....         | 756      |
| Trying out .....                   | 60       |